

LOCAL EXCHANGE TARIFF

UNITED TELEPHONE COMPANY
OF THE WEST d/b/a CenturyLink
NEBRASKA

Twenty-Ninth Revised Sheet 1
Cancels Twenty-Eighth Revised Sheet 1

MONTHLY RATES BY RATE GROUPS

An exchange is placed in a rate group on the basis of the total number of access lines within the local exchange area. The applicable monthly flat **rates** listed **below apply for exchanges across all rate groups (shown on Sheet 2).**

FLAT RATE SERVICE	All Rate Groups
Business Individual Line ⁽¹⁾ (1-PTY)	\$40.00 (I)
Key Trunks	40.00 (I)
PBX Trunks ⁽¹⁾	40.00 (I)
Payphone Line Service ⁽¹⁾	27.50
Residence Individual Line ⁽²⁾ (1-PTY)	23.00

- (1) The applicable Flat Rate Service and the EAS Additive monthly rates will appear as a single item on the customer's bill.
- (2) The applicable Flat Rate Service and the EAS Additive monthly rates will appear as separate items on the customer's bill.

ISSUED:
October 30, 2020

BY: Darlene Terry
Government Affairs Director

EFFECTIVE:
January 29, 2021

NE2021-01

Received by NPSC
01/15/2021

LOCAL EXCHANGE TARIFF

UNITED TELEPHONE COMPANY
OF THE WEST d/b/a CenturyLink
NEBRASKA

Twelfth Revised Sheet 2
Canceling Eleventh Revised Sheet 2

EXCHANGES BY RATE GROUPS

Rate Group	Access Line Limits	Exchanges
1	0-1,500	Bayard, Broadwater, Chappell, Lewellen, Lyman, Minatare, Mitchell, Morrill, Oshkosh, Potter
2	1,501-3,000	Kimball
3	3,001-24,000	Gering, Scottsbluff

EXTENDED AREA SERVICE

Home Exchange	EAS Exchange(s)	Monthly EAS Additives		
		Business ⁽¹⁾		Residence ⁽²⁾
		Ind. Lines/Key Trunks/PBX Trunks	Other	
Bayard	Gering, Lyman, Minatare, Mitchell, Morrill, Scottsbluff, West Lyman WY	\$0.00 (R)	\$5.98	\$0.00
Gering	Bayard, Lyman, Minatare, Mitchell, Morrill, Scottsbluff, West Lyman WY	0.00 (R)	3.89	\$0.00
Lewellen	Oshkosh	0.00 (R)	2.99	\$0.00
Lyman	Bayard, Gering, Minatare, Mitchell, Morrill, Scottsbluff, West Lyman WY	0.00 (R)	5.98	\$0.00
Minatare	Bayard, Gering, Lyman, Mitchell, Morrill, Scottsbluff, West Lyman WY	0.00 (R)	5.98	\$0.00
Mitchell	Bayard, Gering, Lyman, Minatare, Morrill, Scottsbluff, West Lyman WY	0.00 (R)	5.98	\$0.00
Morrill	Bayard, Gering, Lyman, Minatare, Mitchell, Scottsbluff, West Lyman WY	0.00 (R)	5.98	\$0.00
Oshkosh	Lewellen	0.00 (R)	2.99	\$0.00
Scottsbluff	Bayard, Gering, Lyman, Minatare, Mitchell, Morrill, West Lyman WY	0.00 (R)	3.89	\$0.00

(1) The applicable Flat Rate Service and the EAS Additive monthly rates will appear as a single item on the customer's bill.

(2) The applicable Flat Rate Service and the EAS Additive monthly rates will appear as separate items on the customer's bill.

ISSUED:
September 3, 2019

BY: Darlene Terry
Government Affairs Director

NE 19-07

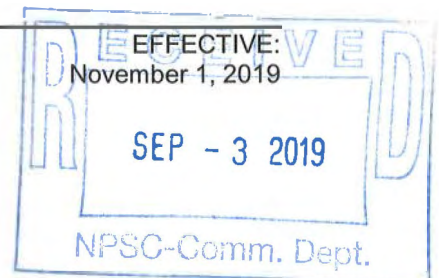

LOCAL EXCHANGE TARIFF

UNITED TELEPHONE COMPANY
OF THE WEST d/b/a CenturyLink
NEBRASKA

Sixth Revised Sheet 2.1
Cancels Fifth Revised Sheet 2.1

A. OPTIONAL LOCAL MEASURED SERVICE (OLMS) - **GRANDFATHERED**

(C)

Effective September 2, 2021, Optional Local Measured Service (OLMS) is grandfathered for Individual Line Service and availability is limited to lines currently in service at existing locations for existing customers.

(N)

|

(N)

1. Application and Regulations

- a. Customers will have under this tariff offering the option of subscribing to Local Measured Service which provides for measured calling to all points within the existing non-toll calling area.
- b. Business and Residence Individual Line customers will have the option of maintaining their current telephone service or changing to local measured service.
- c. Normal service connection charges for existing customers will not apply for a customer's conversion to and/or from the local measured service offering within any twelve-month period and no activity other than this service change takes place. Changes in excess of this allowance will be billed the regular tariff charges as appropriate.
- d. All customer lines at a given location must be arranged for optional local service and equipped for outward calling.
- e. Local usage charges will not apply to calls to the Company Business Office or Repair Service, Directory Assistance, Long Distance Carrier Access Trunks, or for Emergency Service as found in the local exchange telephone directory.
- f. Optional Local measured service will not be provided for Foreign Exchange. This service is also not available for PBX Trunks.
- g. Normally, local measured service calls will be on a direct dial basis, however, at the customers' option, these calls may be billed to a credit card, third number or on sent collect basis. Operator handling charges as specified in Section 32 of the General Exchange Tariff will apply in addition to the normal usage charge.

ISSUED:
August 23, 2021

BY: Darlene Terry
Manager, Tariffs

EFFECTIVE:
September 2, 2021

NE 2021 15

Received by NPSC
08/23/2021

LOCAL EXCHANGE TARIFF

UNITED TELEPHONE COMPANY
OF THE WEST d/b/a CenturyLink
NEBRASKA

Twelfth Revised Sheet 2.2
Canceling Eleventh Revised Sheet 2.2

A. OPTIONAL LOCAL MEASURED SERVICE (OLMS) - **GRANDFATHERED** (Cont'd) (C)

2. Offered in those Nebraska Exchanges where it is technologically and economically feasible.

3. Rates and Charges

a. EAS charges do not apply.

b. Usage charges which consider frequency, duration, and time-of-day are in addition to the basic access line charge.

c. Monthly Rates

Exchanges	Residence Measured One-Party	Business Measured One-Party/ Key Line
Rate Groups 1-3	\$14.85	\$21.50

d. Rates for calls within the existing non-toll calling area.

<u>Usage</u>	<u>1st MOU</u>	<u>Add'l MOU</u>
Exchange	\$.07	\$.07
1-45 miles	.07	.07

ISSUED:
August 23, 2021

BY: Darlene Terry
Manager, Tariffs

EFFECTIVE:
September 2, 2021

NE2021-15

Received by NPSC
08/23/2021

LOCAL EXCHANGE TARIFF

UNITED TELEPHONE COMPANY
OF THE WEST d/b/a CenturyLink
NEBRASKA

Fourth Revised Sheet 2.3
Cancels Third Revised Sheet 2.3

A. OPTIONAL LOCAL MEASURED SERVICE (OLMS) - **GRANDFATHERED** (Cont'd) (C)

3. Rates and Charges (Cont'd)

d. Additional Charges

Detail billing showing all calls
placed from Customer's LMS access
line, per call \$.03

e. Ceiling

The maximum charge per LMS line for the access line and usage charges will be 150% of the flat rate access line (including EAS charges and excluding terminal equipment) for the class of service provided (i.e., R-1, B-1) rounded to the nearest nickel. Not included in this ceiling will be additional charges for operator assistance or detail billing as specified in Section 32 of the General Exchange Tariff and paragraph A., 3., e. preceding.

ISSUED:
August 23, 2021

BY: Darlene Terry
Manager, Tariffs

EFFECTIVE:
September 2, 2021

LOCAL EXCHANGE TARIFF

UNITED TELEPHONE COMPANY
OF THE WEST
NEBRASKA

Original Sheet 3

B. TERM DISCOUNT PLAN (TDP)

1. General

- a. A Term Discount Plan (TDP) provides business customers in the Scottsbluff and Gering exchanges with discounted rates for one or more Flat Rate Service Business Lines and/or Trunks. The discount also applies to the EAS Additive rate component.
- b. Flat Rate Service Business Lines and Trunks may be ordered under a TDP for fixed periods of two (2) years and three (3) years.
- c. The customer must specify the length of the initial service period at the time the service is ordered.
- d. At the end of the TDP commitment period the customer may subscribe to a new TDP at discounts on the prevailing rates as set forth in B.3. following. If the customer does not specify renewal terms in writing 90 days prior to the expiration of the TDP, the commitment period and the discount in effect at the time of expiration will automatically be extended for 12 months. The customer can terminate service at the end of the minimum commitment period with no penalty or obligation to continue the service
- e. Rate increases or decreases will automatically be applied to the monthly term plan rates for the remaining term of the TDP. If a Company initiated rate increase causes the services under the TDP to increase by 10% or more annually, then the customer may cancel the TDP without incurring termination liability charges provided the customer notifies the Company within 30 days after the effective date of the rate increase.
- f. The customer can extend TDP commitment periods at any time during the term of the plan, up to a maximum of three years. The number of remaining months in the original term plan will apply toward the new term plan selected.

2. Termination Liability Charges

- a. If a business customer under a Term Discount Plan (TDP) disconnects any portion of the Flat Rate Service Business Lines and Trunks TDP service prior to the expiration of the TDP, then a Termination Liability Charge will apply to those services that are disconnected. The Termination Liability Charge will be a one-time charge of \$100.00 for each Flat Rate Service Business Line or Trunk that is prematurely disconnected.

3. Discounts ⁽¹⁾

	<u>Two Years</u>	<u>Three Years</u>
a. Business Flat Rate Service Rates	10%	15%
b. Trunks Flat Rate Service Rates	10%	15%

⁽¹⁾ Only available in the Scottsbluff and Gering exchanges.



LOCAL EXCHANGE TARIFF

UNITED TELEPHONE COMPANY
OF THE WEST
NEBRASKA

First Revised Sheet 4
Cancels Original Sheet 4

C. CENTURYLINK LINE VOLUME PLAN (CLVP)

1. General

- a. CenturyLink Line Volume Plan (CLVP) is available to business customers subscribing to 10 or more basic business lines, key lines or key trunks. A customer may have a maximum of 3,000 participating lines across all service territories served by CenturyLink incumbent local exchange carriers (each, a CenturyLink ILEC)^[1]. Lines served by a CenturyLink competitive local exchange carrier (CLEC) are not contributory to or eligible for CLVP. (C)
- b. CLVP is offered as a tiered plan with each tier having a Minimum Line Requirement. Lines and/or key trunks provided by a CenturyLink ILEC which are already discounted under an existing term discount plan, line volume plan or any contractual arrangement which contains a volume and/or minimum term commitment, may contribute to the aggregate line count used for determining the applicable tier and rates for services under this CLVP, but are not eligible for additional discounts under this CLVP.
- c. The terms, conditions, and application of rates for services in Qwest Corporation locations may differ from those contained herein, and are as described in the applicable tariffs, catalogs, and/or other local terms of service documents for those service locations.

2. Regulations

- a. Qualifying CLVP services in locations other than those served by Qwest Corporation are defined as follows:
 - Flat rate business individual lines – local exchange service terminating into a single line instrument.
 - Flat rate key lines or key trunks – local exchange service terminating into any system classified as a key system pursuant to FCC Part 68 Rules and any hybrid system designed to function like a key system, e.g. an outbound line is manually selected, usually by pushing a button on the handset, rather than being selected automatically (usually by dialing 9).

^[1] **Effective October 19, 2022, CLVP term agreements will no longer renew automatically. Current term agreements will be grandfathered at their assigned Tier until they expire. Upon expiration of current term agreements, lines provided by former CenturyLink ILECs will not be contributory to or eligible for CenturyLink Line Volume Plan provided under this tariff, and all contributory and eligible lines must be provided by a current CenturyLink ILEC.** (N)

ISSUED:
October 7, 2022

BY: Darlene Terry
Manager, Tariffs

EFFECTIVE:
October 19, 2022

Received by NPSC
10/7/2022

C. CENTURYLINK LINE VOLUME PLAN (CLVP) (Continued)

2. Regulations (Continued)

- b. CLVP Feature Package, consisting of Customer's choice of any of the following features (where offered), is available in conjunction with any qualifying service:

- Caller ID (includes Anonymous Call Rejection, where available)
- Call Forwarding
- Call Forward Busy
- Call Forward No Answer
- Call Forward-Remote Access (Not currently available)
- Enhanced Call Waiting
- Three-Way Calling
- Three-Way Calling with Transfer
- Call Return
- Distinctive Ring aka SignalRing
- Message Waiting Indicator^[1]
- Voicemail^[1]

- c. The terms and conditions for qualifying services and optional features apply as specified in applicable CenturyLink tariffs, guidebooks, schedules, and/or other local terms of service documents, unless stated otherwise herein.
- d. CLVP rates are based on line volume and a term commitment period of two, three, four or five years.^[2] Customers may not have more than one CLVP tier and term commitment period in effect across all CenturyLink service locations except as described in e. following. Rates for qualifying services at new service locations will be charged based on the already established tier and commitment period. Any lines added after execution of the initial CLVP are contributory towards the Minimum Line Commitment but will not prompt a change in the assigned tier for the previously established lines.
- e. Customers with a previously existing CLVP offered by Qwest Corporation may select a separate (second) CLVP for services in an eligible location other than Qwest Corporation. Lines in all CenturyLink ILEC service locations, including locations served by Qwest Corporation, may, at Customer's request, be contributory towards determining the tier for the second CLVP. Services in a Qwest Corporation service location are not eligible for the rates associated with the tier assigned for the second CLVP and will continue to be charged at the tier rates under the original CLVP offered by Qwest Corporation for the remainder of its term commitment period.

Alternatively, customers may discontinue a previously existing CLVP and establish a new CLVP as described in J. following, in which instance a new tier will be established and will apply for all service locations.

^[1] This service is not regulated under this tariff.

^[2] **Effective October 19, 2022, CLVP term agreements will no longer renew automatically. Current term agreements will be grandfathered at their assigned Tier until they expire. Upon expiration of current term agreements, lines provided by former CenturyLink ILECs will not be contributory to or eligible for CenturyLink Line Volume Plan provided under this tariff, and all contributory and eligible lines must be provided by a current CenturyLink ILEC.**

ISSUED:
October 7, 2022

BY: Darlene Terry
Manager, Tariffs

EFFECTIVE:
October 19, 2022

(C)

(N)

(N)

LOCAL EXCHANGE TARIFF

UNITED TELEPHONE COMPANY
OF THE WEST d/b/a CenturyLink
NEBRASKA

Second Revised Sheet 6
Cancels First Revised Sheet 6

C. CENTURYLINK LINE VOLUME PLAN (CLVP) (Continued)

2. Regulations (Continued)

- f. All qualifying services must be associated with the same customer. The Company may, at its discretion, provide this plan to Affiliates or Franchisees of Customer. An Affiliate or Franchisee is an entity whose operation of business is substantially associated with Customer's name, mark, or commercial symbol. When, at the Company's discretion, this plan is provided to Affiliates or Franchisees of Customer, Customer must designate the specific account to which Early Termination Charges and Shortfall Penalties will be applied.
- g. Services subject to rates under this CLVP are not eligible for discounted rates under any other local voice discount plan. Only the qualifying services listed in 2a. preceding are both contributory to and eligible for the CLVP rates herein^[1]. However, a line or key trunk in any packaged service may contribute towards the minimum line requirement. PBX trunks are neither eligible for or contributory to CLVP for purposes of determining the appropriate rate tier and minimum line requirement. (C)
- h. Customers may select a CLVP tier lower than their actual quantity of contributory services.
- i. Customers subscribed to a Term Discount Plan (TDP) described in a Tariff or Local Terms of Service may migrate lines and/or key trunks to CLVP without incurring early termination liability charges. All other lines and/or key trunks receiving promotional or competitive response discounts or recurring charge waivers under other term commitment programs are not eligible for CLVP rates until the terms of those offers have been satisfied for those lines.
- j. Additional business lines may be added at any time during Customer's term commitment period, but will not affect the tier and monthly discount levels established upon execution of the CLVP agreement unless Customer commits to a new agreement for a greater number of lines than the existing agreement. Rates applicable under the new agreement will not apply retroactively nor will the months accrued under the initial agreement apply towards the new commitment period.
- k. Customer may move all or some of the lines under this CLVP to any eligible CenturyLink service location without incurring termination charges, as long as Customer maintains the overall minimum line requirement. The CLVP rates for relocated lines are as specified in the appropriate CenturyLink tariffs, guidebooks, schedules, and/or local terms of service documents for the new service location.

^[1] **Effective October 19, 2022, CLVP term agreements will no longer renew automatically. Current term agreements will be grandfathered at their assigned Tier until they expire. Upon expiration of current term agreements, lines provided by former CenturyLink ILECs will not be contributory to or eligible for CenturyLink Line Volume Plan provided under this tariff, and all contributory and eligible lines must be provided by a current CenturyLink ILEC.** (N)

ISSUED:
October 7, 2022

BY: Darlene Terry
Manager, Tariffs

EFFECTIVE:
October 19, 2022

LOCAL EXCHANGE TARIFF

UNITED TELEPHONE COMPANY
OF THE WEST
NEBRASKA

First Revised Sheet 7
Cancels Original Sheet 7

C. CENTURYLINK LINE VOLUME PLAN (CLVP) (Continued)

3. Early Termination Liability

- a. If CenturyLink terminates the Service(s) for cause, or if Customer terminates the Services(s) in whole without cause before expiration of the initial commitment period, the customer will pay termination charges of \$15.00 per line of the customer's Minimum Line Requirement multiplied by the remaining number of months left on the Term. For example: a customer terminating all service with 3 months remaining on the Term and a Minimum Line Requirement of 50 lines will pay $\$15.00 \times 50 \times 3 = \$2,250.00$.
- b. If during an annual review of Customer's account, the account falls below the Minimum Line Requirement for the discount tier, the customer will pay a shortfall penalty of \$60.00 for each line below the Minimum Line Requirement. If the customer is charged a shortfall charge, the Company may subsequently conduct quarterly audits and apply shortfall charges until the customer meets the Minimum Line Requirement. ^[1]
- c. The optional CLVP Feature Package does not contribute to the discount tier and is not subject to termination charges or shortfall penalty.
- d. Early Termination Liability charges will be waived for CLVP customers who commit to a new term agreement that includes the same or greater number of equivalent lines or similar services (e.g. channels within a 1.544 Mbps service) for the same or greater term than their existing agreement. Months accrued under the CLVP term commitment period will not apply towards the new commitment period.

(C)

^[1] **Effective October 19, 2022, CLVP term agreements will no longer renew automatically. Current term agreements will be grandfathered at their assigned Tier until they expire. Upon expiration of current term agreements, lines provided by former CenturyLink ILECs will not be contributory to or eligible for CenturyLink Line Volume Plan provided under this tariff, and all contributory and eligible lines must be provided by a current CenturyLink ILEC.**

(N)

(N)

ISSUED:
October 7, 2022

BY: Darlene Terry
Manager, Tariffs

EFFECTIVE:
October 19, 2022

Received by NPSC
10/7/2022

C. CENTURYLINK LINE VOLUME PLAN (CLVP) (Continued)

4. Application of Rates

- a. Touch calling service charges and/or Extended Area Service charges normally billed in addition to the local exchange service rate are included in the rates specified herein. Charges for lines and key trunks in a hunting arrangement (a.k.a. rotary line service or rotary access service) that would otherwise apply as an incremental charge are also included in the rates specified herein.
- b. Customers will not incur service charges or other nonrecurring charges when switching existing basic business line service to CLVP.
- c. Nonrecurring charges and/or Service Charges will apply as specified in applicable CenturyLink tariffs, guidebooks, schedules, and/or local terms of service documents. Nonrecurring charges may be waived if customer moves future services from another telecommunications service provider to lines under the CLVP. However, such subsequently moved lines will not affect the tier and monthly discount level established upon execution of this agreement.
- d. Qualifying services may be aggregated across the entire CenturyLink Incumbent LEC service territory to determine the applicable Tier (based on total number of lines). The monthly rate(s) in effect for each service location upon execution of a CLVP agreement will apply for the duration of the term commitment period, and are not subject to Company initiated rate increases.
- e. **Effective October 19, 2022, CLVP term agreements will no longer renew automatically. Current term agreements will be grandfathered at their assigned Tier until they expire. Upon expiration of current term agreements, lines provided by former CenturyLink ILECs will not be contributory to or eligible for CenturyLink Line Volume Plan provided under this tariff, and all contributory and eligible lines must be provided by a current CenturyLink ILEC.** If, at the end of the CLVP term commitment period, Customer has not executed a new agreement, the rates for business individual lines and/or key lines/trunks, including lines/trunks in a hunting arrangement (a.k.a. rotary line service or rotary access service), and ala carte rates for optional features selected with CLVP Feature Package, if applicable, will revert to the non-contractual monthly rates in effect for those services as specified in CenturyLink's tariffs, guidebooks, schedules, and/or other local terms of service documents.

(C)

(C)

ISSUED:
October 7, 2022

BY: Darlene Terry
Manager, Tariffs

EFFECTIVE:
October 19, 2022

Received by NPSC
10/7/2022

LOCAL EXCHANGE TARIFF

UNITED TELEPHONE COMPANY
OF THE WEST
NEBRASKA

First Revised Sheet 9
Cancels Original Sheet 9

C. CENTURYLINK LINE VOLUME PLAN (CLVP) (Continued)

4. Application of Rates

- f. If, at any time during **the term commitment period**, Customer's total number of qualifying services fall below the minimum number of lines required to receive the CLVP discounted rates, the lines/trunks will no longer qualify for CLVP rates and will be charged at the prevailing non-contractual monthly rates for business individual lines and/or key lines/trunks, including lines/trunks in a hunting arrangement (a.k.a. rotary line service or rotary access service), as specified in CenturyLink tariffs, guidebooks, schedules, and/or other local terms of service documents. Lines/trunks reverted to non-contractual monthly rates will no longer qualify for the CLVP Feature Package rate, and features associated with those lines will be charged at the prevailing non-contractual monthly ala carte feature rates. Early termination liability charges will not apply for any lines disconnected or reverted to monthly rates after expiration of the initial term commitment period. (C)
- g. The CLVP Feature Package rate applies in addition to the Flat Rate Business Service rate. When applicable, the Flat Rate Business Service and CLVP Feature Package will appear as a single line item on the customer's bill.

ISSUED:
October 7, 2022

BY: Darlene Terry
Manager, Tariffs

EFFECTIVE:
October 19, 2022

Received by NPSC
10/7/2022

LOCAL EXCHANGE TARIFF

UNITED TELEPHONE COMPANY
OF THE WEST
NEBRASKA

First Revised Sheet 10
Cancels Original Sheet 10

C. CENTURYLINK LINE VOLUME PLAN (CLVP) (Continued)

5. Rates

- a. Flat Rate Business Service, per Individual Line, Key Line, and/or Key Trunk, per month ^[1]

Number of Lines (Tier)/Minimum Line Requirement ^[2]	Two Year Term	Three - Five Year Terms
10 - 49	\$28.99	\$27.99
50 - 499	27.99	26.99
500 - 999	26.99	25.99
1000 - 3000	25.99	24.99

(C)

- b. Optional Services
LVP Feature Package, per line/ trunk, per month

Number of Lines (Tier)/Minimum Line Requirement ^[2]	Two Year Term	Three - Five Year Terms
10 - 49	\$10.00	\$10.00
50 - 499	10.00	10.00
500 - 999	10.00	10.00
1000 - 3000	10.00	10.00

(C)

^[1] Touch calling service, Trunk Hunting and Extended Area Service, where applicable, are included in these rates.

^[2] **Effective October 19, 2022, CLVP term agreements will no longer renew automatically. Current term agreements will be grandfathered at their assigned Tier until they expire. Upon expiration of current term agreements, lines provided by former CenturyLink ILECs will not be contributory to or eligible for CenturyLink Line Volume Plan provided under this tariff, and all contributory and eligible lines must be provided by a current CenturyLink ILEC.**

(N)

(N)

ISSUED:
October 7, 2022

BY: Darlene Terry
Manager, Tariffs

EFFECTIVE:
October 19, 2022

LOCAL EXCHANGE TARIFF

UNITED TELEPHONE COMPANY
OF THE WEST d/b/a CenturyLink
NEBRASKA

1st Revised Sheet 11
Cancels Original Sheet 11

D. RESERVED

(C)

(D)

(D)

ISSUED:
October 21, 2021

BY: Darlene Terry
Manager, Tariffs

EFFECTIVE:
November 1, 2021

NE2021-19

Received by NPSC
10/21/2021

LOCAL EXCHANGE TARIFF

UNITED TELEPHONE COMPANY
OF THE WEST d/b/a CenturyLink
NEBRASKA

1st Revised Sheet 12
Cancels Original Sheet 12

D. **RESERVED** (Continued)

(C)

(D)

(D)

ISSUED:
October 21, 2021

BY: Darlene Terry
Manager, Tariffs

EFFECTIVE:
November 1, 2021

NE2021-19

Received by NPSC
10/21/2021

THE UNITED TELEPHONE COMPANY
 OF THE WEST
 LOCAL EXCHANGE TARIFF
 NEBRASKA

EXCHANGE: BAYARD
 Second Revised Sheet 3M

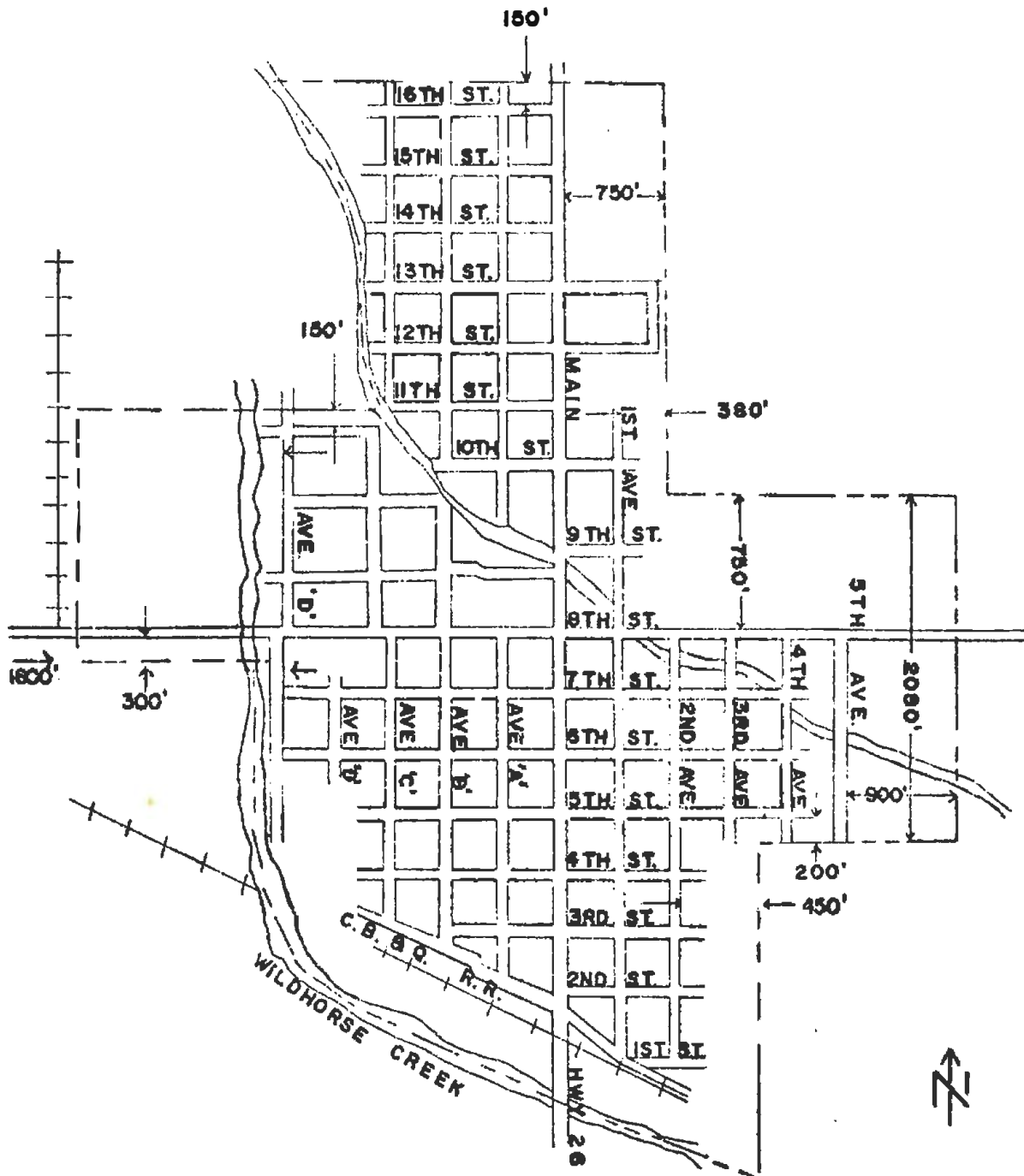

BAYARD BASE RATE AREA

--- BOUNDARY

Issued: August 7, 1979

Effective: January 6, 1980

By DAVID C. BAKER
 Vice President & General Manager

THE UNITED TELEPHONE COMPANY
OF THE WEST
LOCAL EXCHANGE TARIFF
NEBRASKA

BAYARD-EXCHANGE
MAP NO. 6

RECEIVED
DEC 1-8 1981
ACCT. & ENGI. DEPARTMENT
Nebr. Public Service Commission

— EXCHANGE BOUNDARY
■ BASE RATE AREA
- - - ZONE BOUNDARY

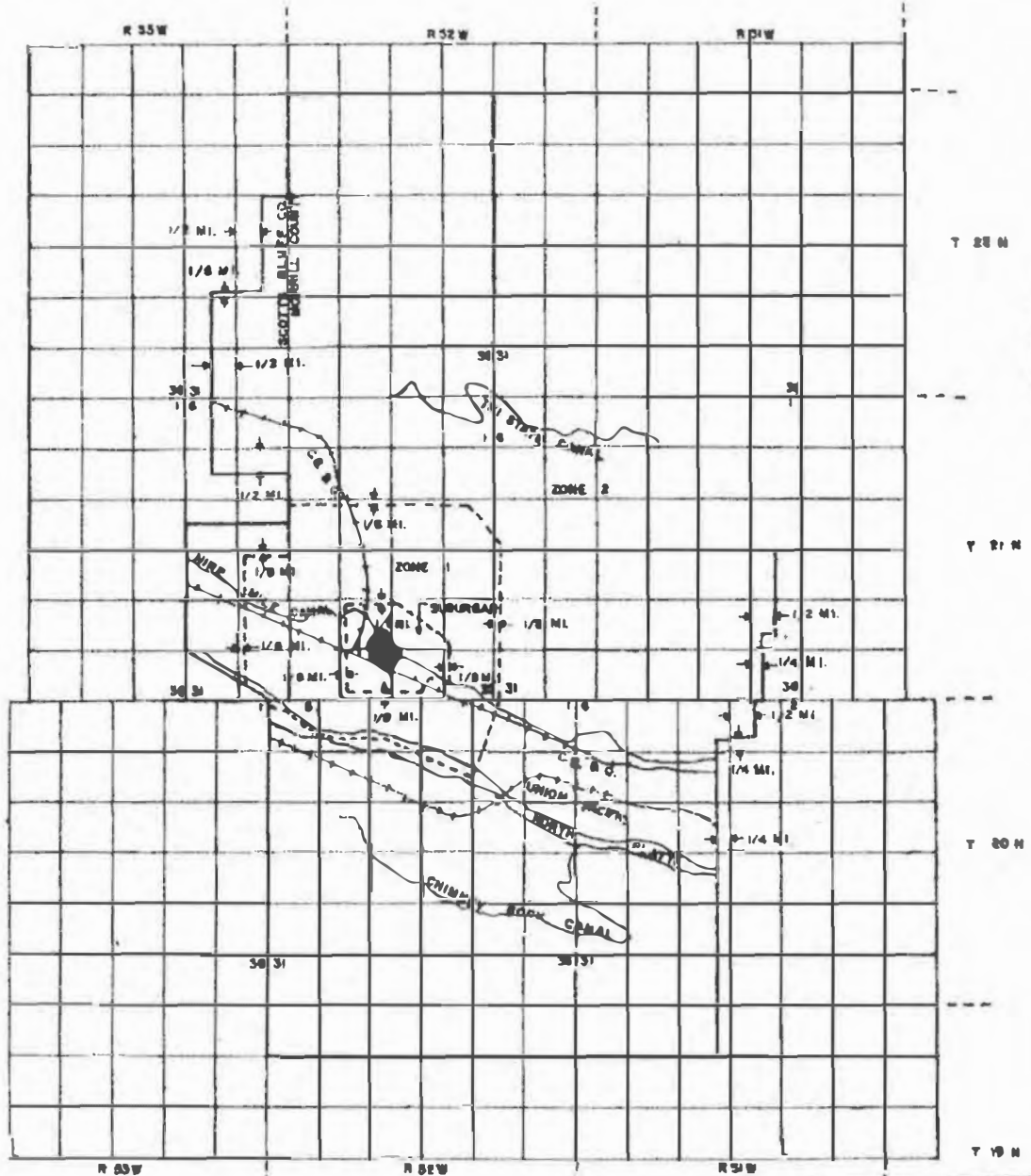

RECEIVED
DEC 1-8 1981
ACCT. & ENGI. DEPARTMENT
Nebr. Public Service Commission

ISSUED: NOVEMBER 17, 1981

EFFECTIVE: NOVEMBER 19, 1981

BY R. M. GRAVES
VICE PRESIDENT

THE UNITED TELEPHONE COMPANY
OF THE WEST
LOCAL EXCHANGE TARIFF
NEBRASKA

EXCHANGE: BROADWATER

First Revised Sheet 4M

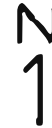

BROADWATER BASE RATE AREA

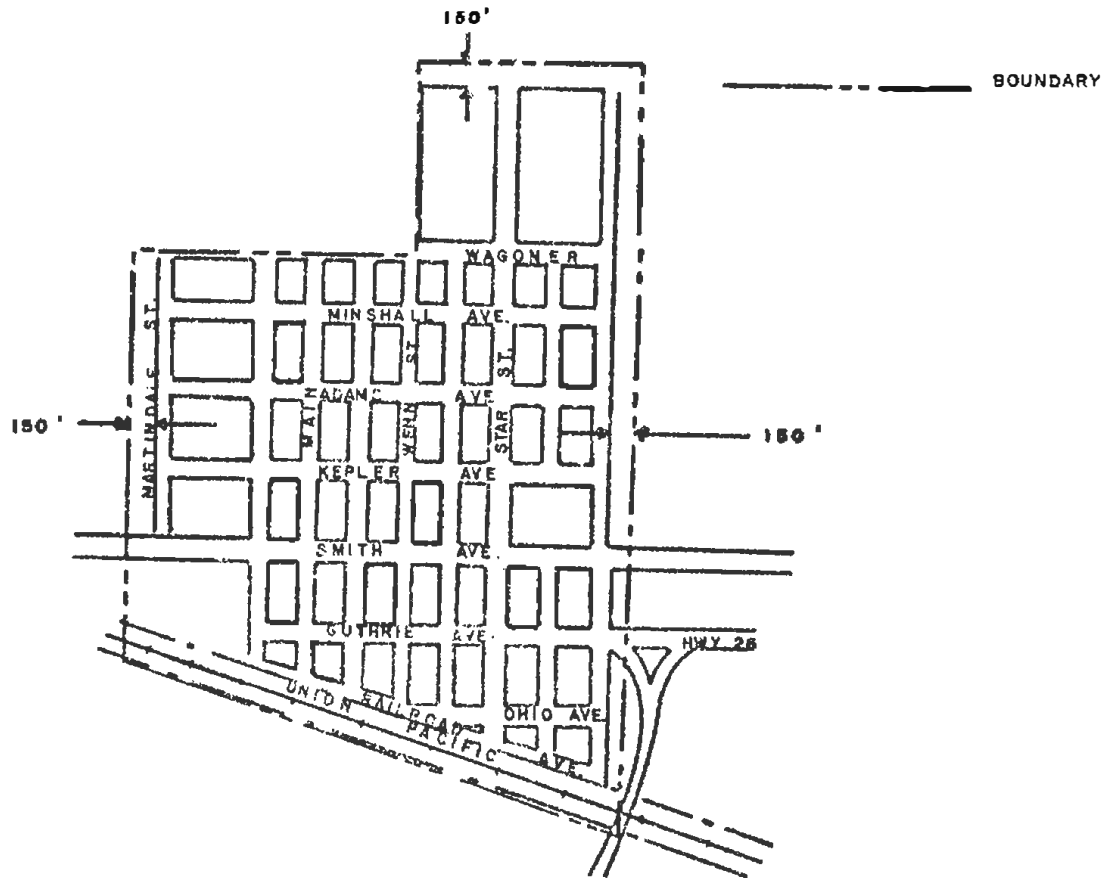

Issued: August 7, 1979

Effective: January 6, 1980

By DAVID C. BAKER
Vice President & General Manager

THE UNITED TELEPHONE COMPANY
 OF THE WEST
 LOCAL EXCHANGE TARIFF
 NEBRASKA

BROADWATER - EXCHANGE

MAP NO. 5

RECEIVED
 ZONE DEC 18 1981
 BOUNDARY
 ACCT. & ENGI. DEPARTMENT
 Nebr. Public Service Commission

— EXCHANGE BOUNDARY
 — BASE RATE AREA
 - - - ZONE BOUNDARY

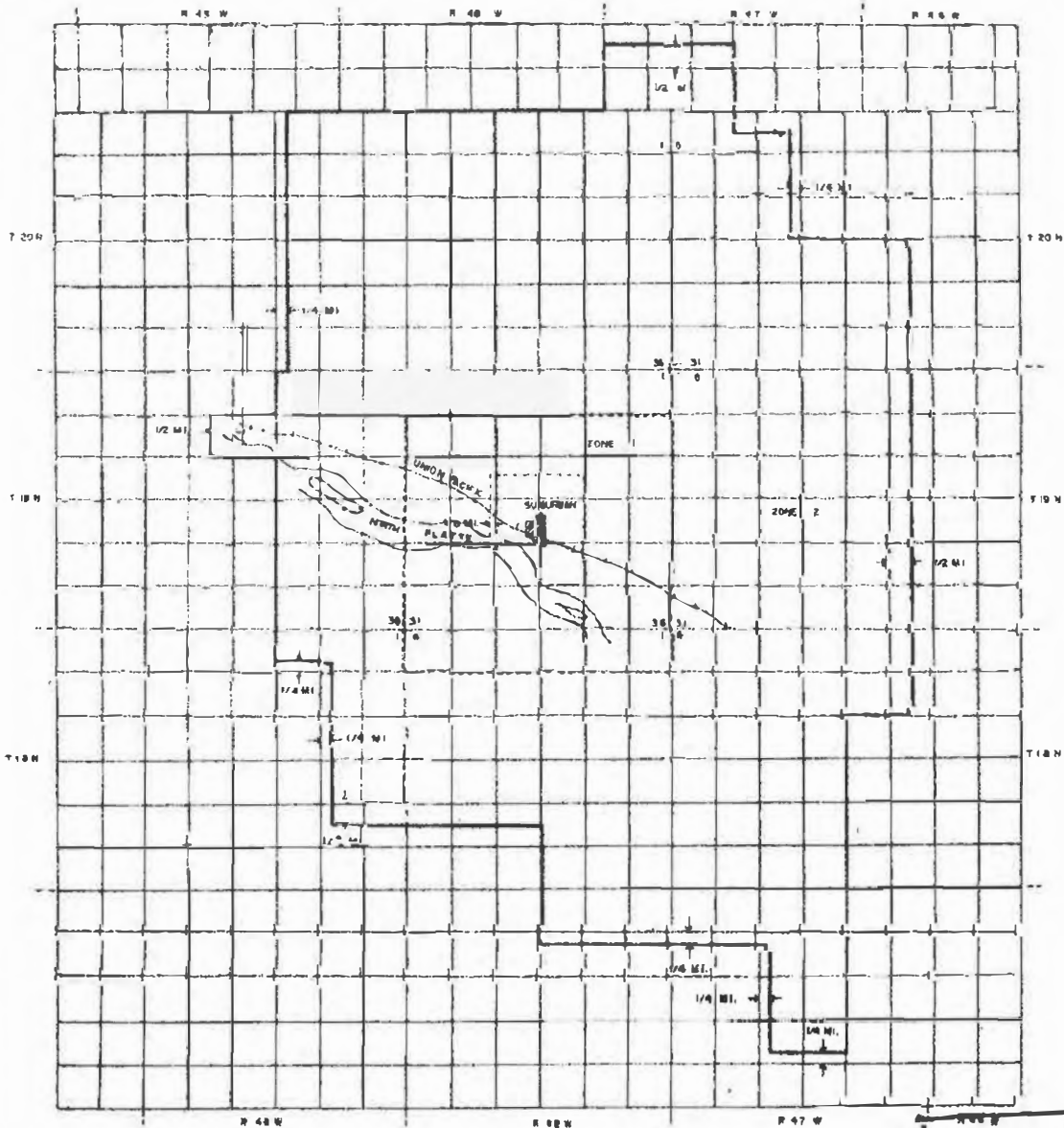

RECEIVED
 DEC 18 1981
 ACCT. & ENGI. DEPARTMENT
 Nebr. Public Service Commission
 NOVEMBER 13, 1981

ISSUED: NOVEMBER 17, 1981

BY R. M. GRAVES
 VICE PRESIDENT

EFFECTIVE

THE UNITED TELEPHONE COMPANY
OF THE WEST
LOCAL EXCHANGE TARIFF
NEBRASKA

EXCHANGE: CHAPPELL

First Revised Sheet 5M

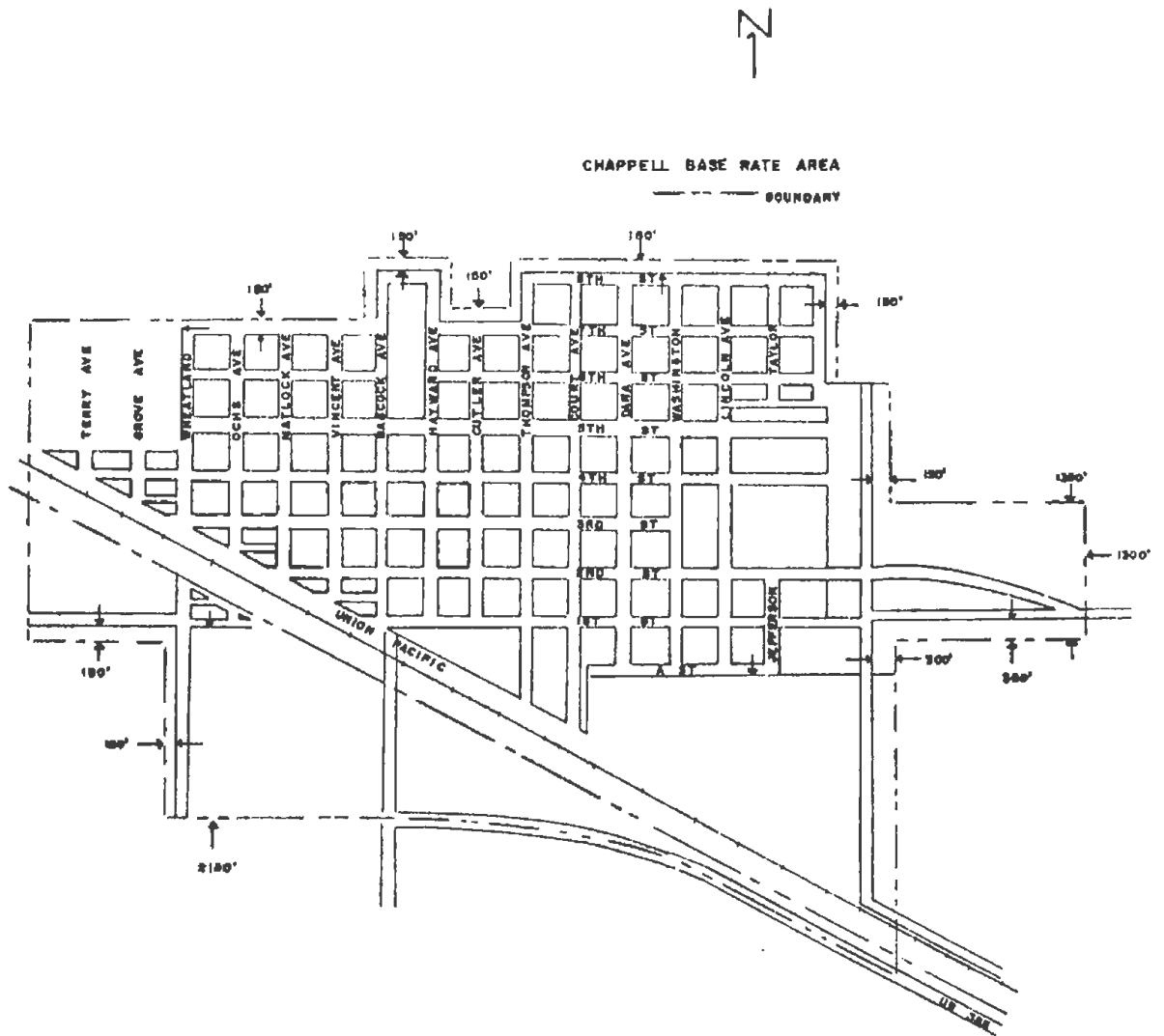

Issued: August 7, 1979

Effective: January 6, 1980

By DAVID C. BAKER
Vice President & General Manager

RECEIVED
 DEC 18 1981
 ACCT. & ENGI. DEPARTMENT
 Nebr. Public Service Commission

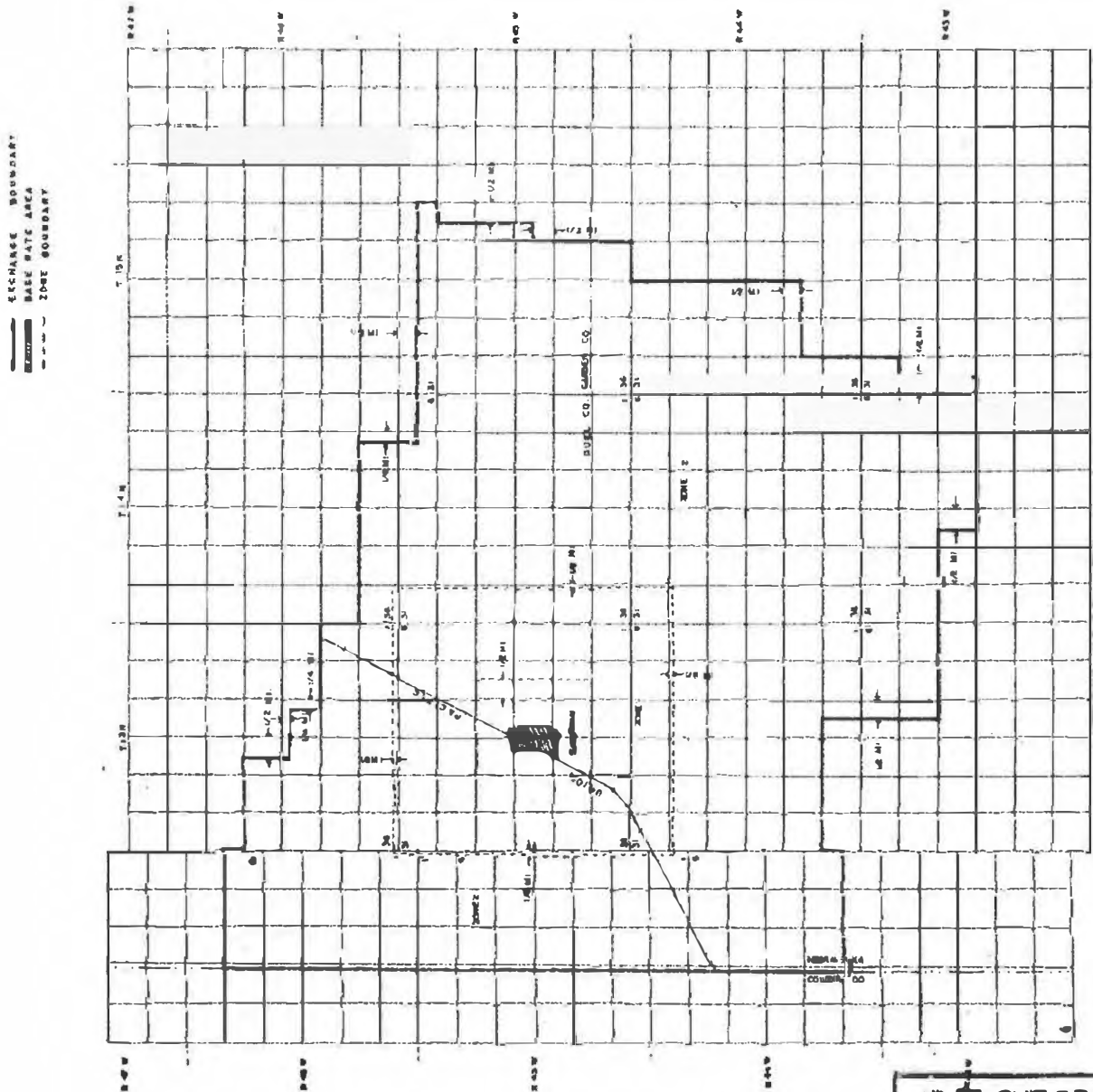

RECEIVED
 DEC 18 1981
 ACCT. & ENGI. DEPARTMENT
 Nebr. Public Service Commission

ISSUED: NOVEMBER 17, 1981

EFFECTIVE: NOVEMBER 19, 1981

BY R. M. GRAVES
 VICE PRESIDENT

THE UNITED TELEPHONE COMPANY
 OF THE WEST
 LOCAL EXCHANGE TARIFF
 NEBRASKA

EXCHANGE: GERING
 Third Revised Sheet 6M

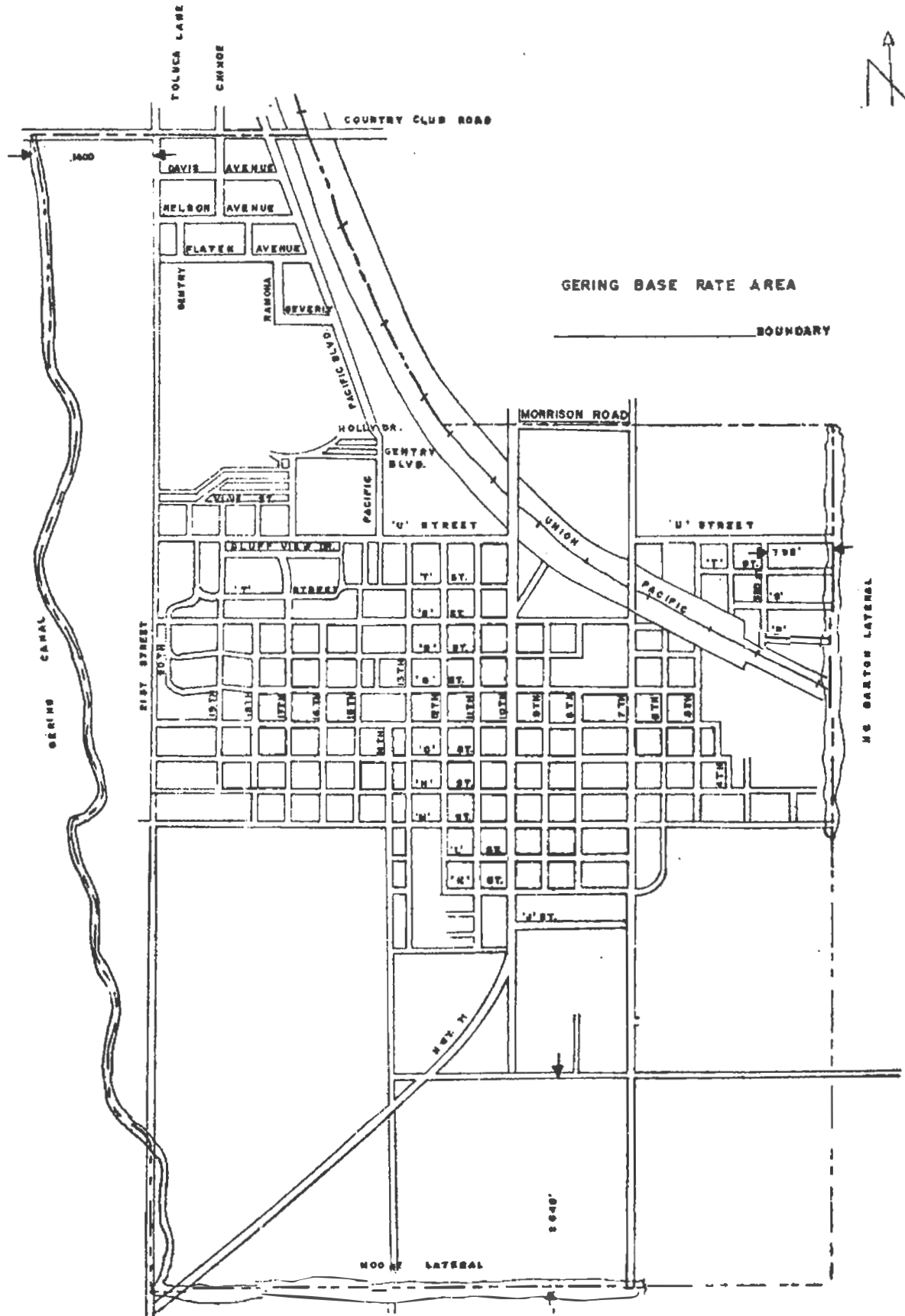

Issued: August 7, 1979

Effective: January 6, 1980

By DAVID C. BAKER
 Vice President & General Manager

THE UNITED TELEPHONE COMPANY
OF THE WEST
LOCAL EXCHANGE TARIFF
NEBRASKA

GERING - EXCHANGE

MAP NO. 6

ZONE
BOUNDARY
MAP

RECEIVED
DEC 1-8 1981
ACCT. & ENGI. DEPARTMENT
Nebr. Public Service Commission

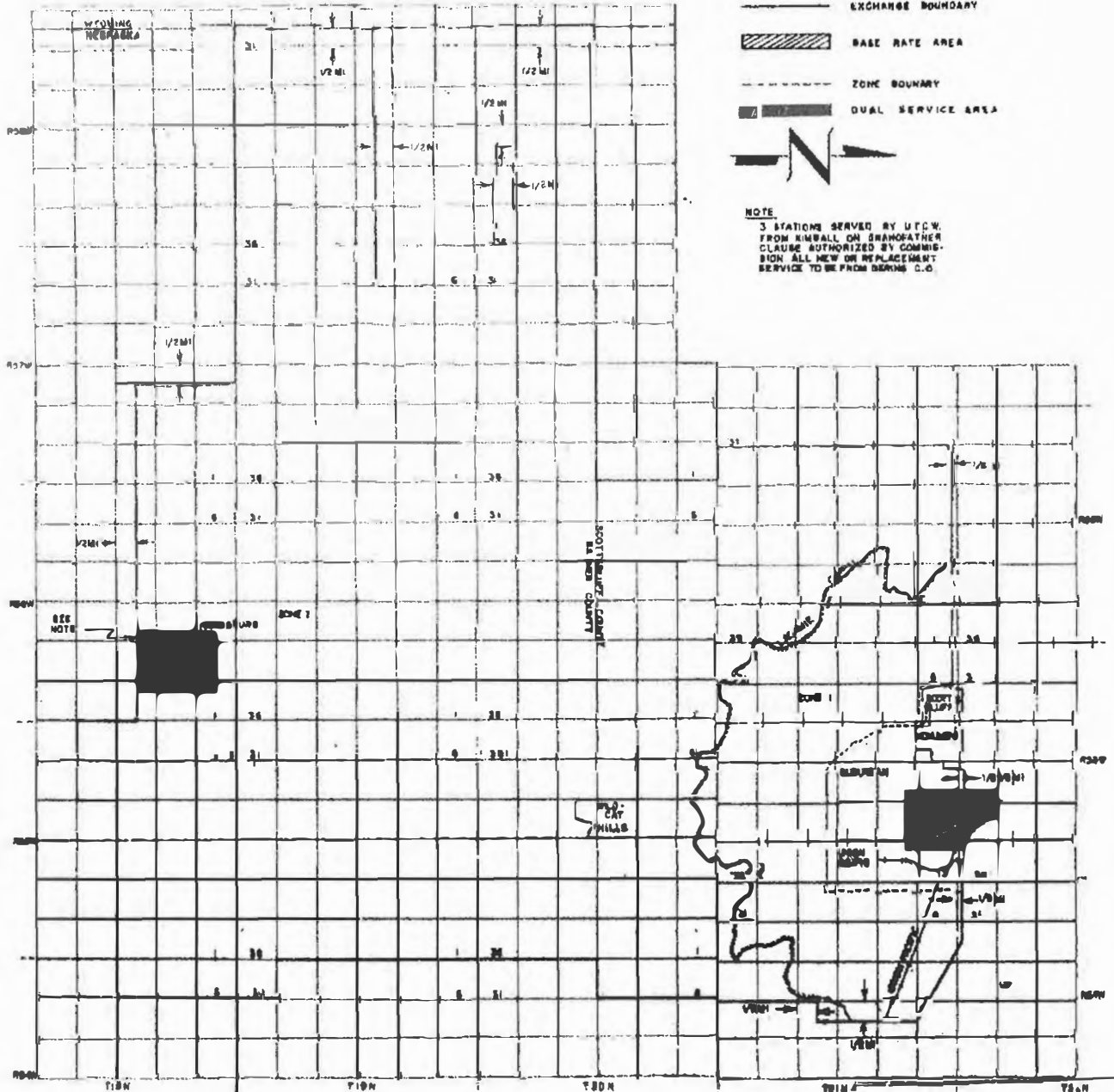

RECEIVED
DEC 1-8 1981
ACCT. & ENGI. DEPARTMENT
Nebr. Public Service Commission

ISSUED: NOVEMBER 17, 1981

EFFECTIVE: NOVEMBER 17, 1981

BY R. M. GRAVES
VICE PRESIDENT

THE UNITED TELEPHONE COMPANY
OF THE WEST
LOCAL EXCHANGE TARIFF
NEBRASKA

EXCHANGE: KIMBALL
First Revised Sheet 14M

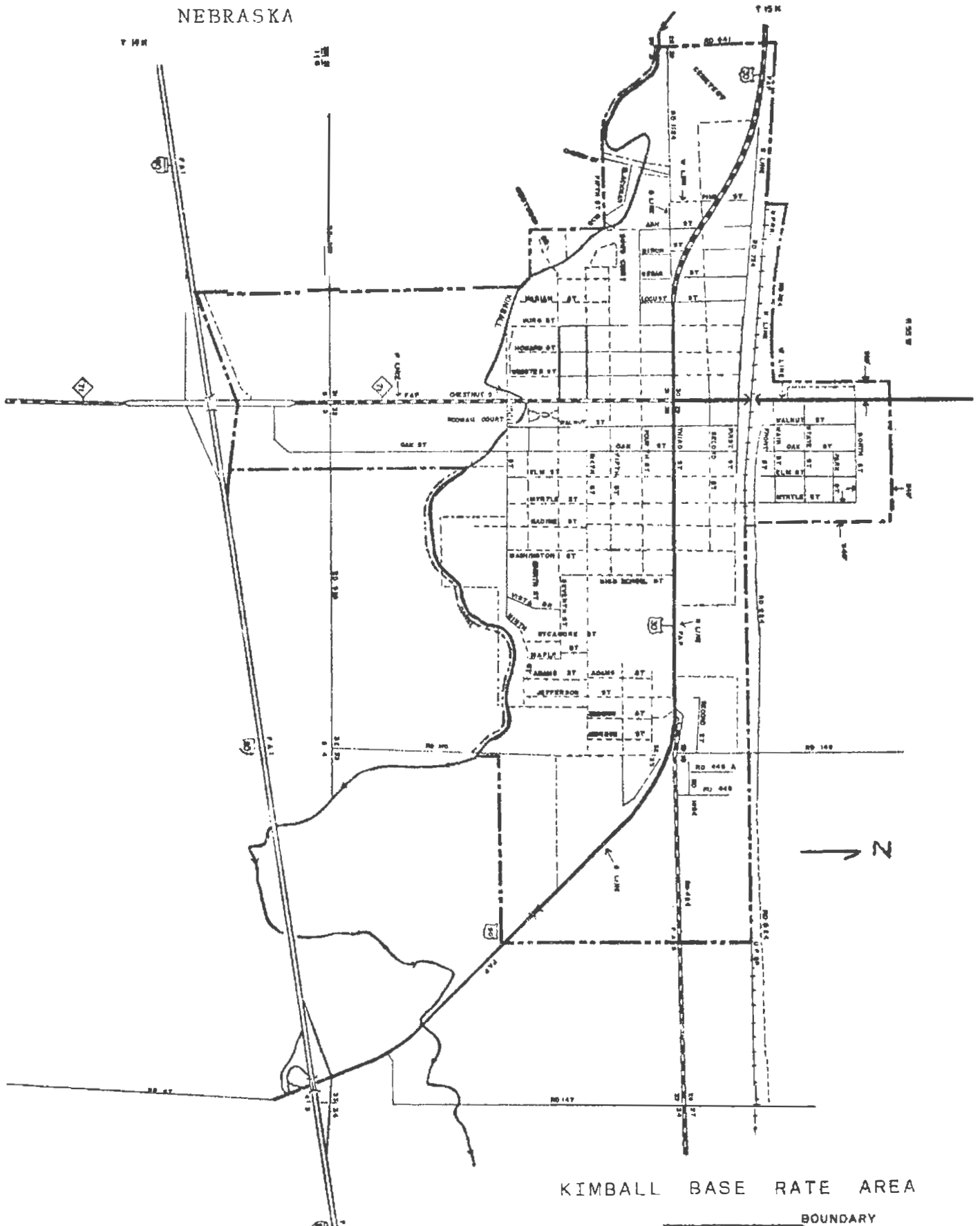

KIMBALL BASE RATE AREA
BOUNDARY

Issued: August 7, 1979

Effective: January 6, 1980

By DAVID C. BAKER
Vice President & General Manager

RECEIVED
DEC 1-8 1981
ACCT. & ENGI. DEPARTMENT
Nebr. Public Service Commission

KIMBALL - EXCHANGE
MAP NO. 4

ZONE
BOUNDARY
MAP

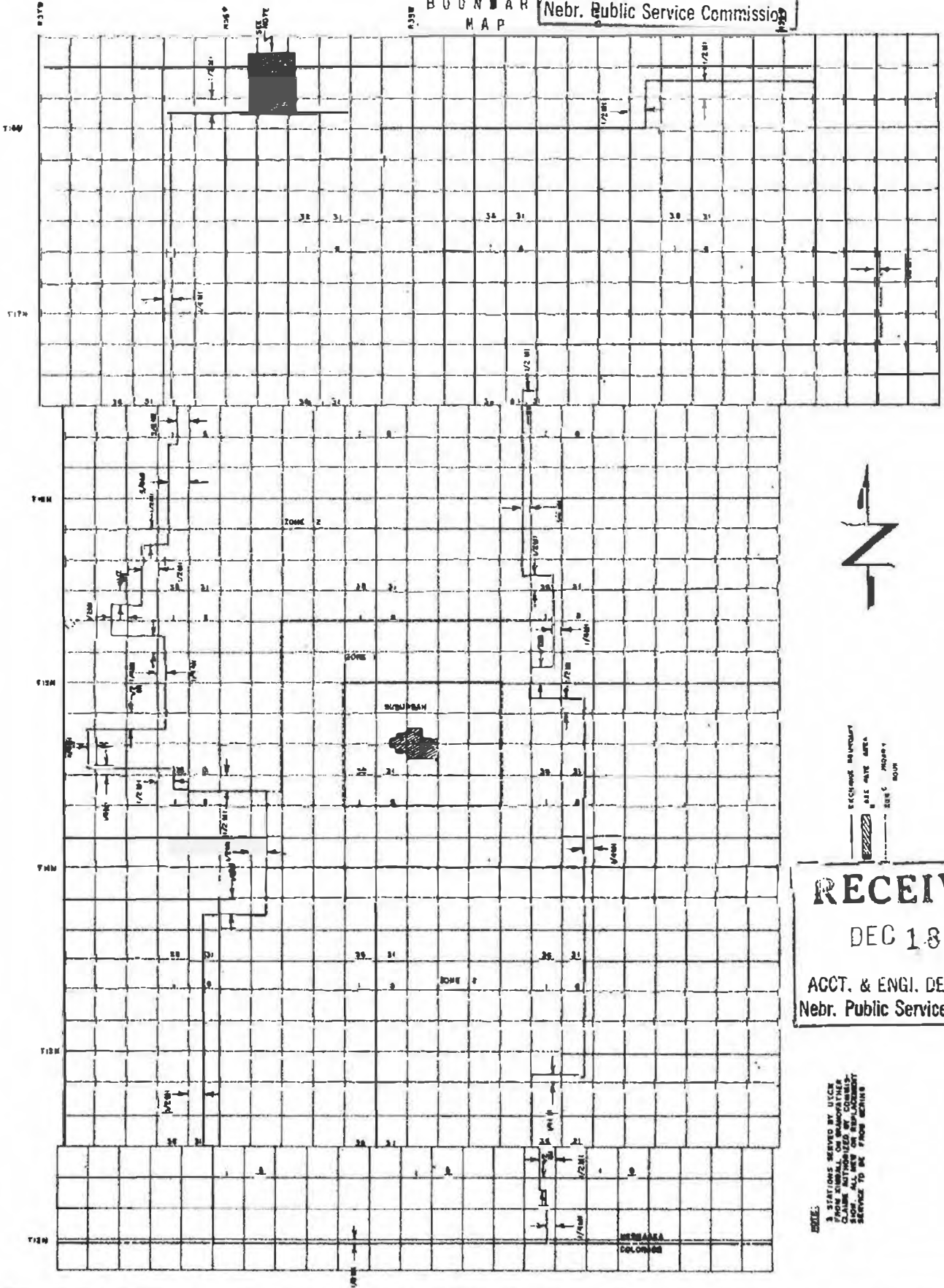

EXCHANGE BOUNDARY
SEE NOTE AREA
SEE PROPERTY
SEE TOWN

RECEIVED
DEC 1-8 1981
ACCT. & ENGI. DEPARTMENT
Nebr. Public Service Commission

NOTE:
A STATION SERVING BY LICENSURE FROM KIMBALL ON MAINTENANCE CLAIMS AUTHORIZED BY COMMISSION SERVICE TO BE FROM KIMBALL

BY R. M. GRAVES
VICE PRESIDENT

THE UNITED TELEPHONE COMPANY
 OF THE WEST
 LOCAL EXCHANGE TARIFF
 NEBRASKA

EXCHANGE: LEWELLEN

First Revised Sheet 7M



LEWELLEN BASE RATE AREA

----- BOUNDARY

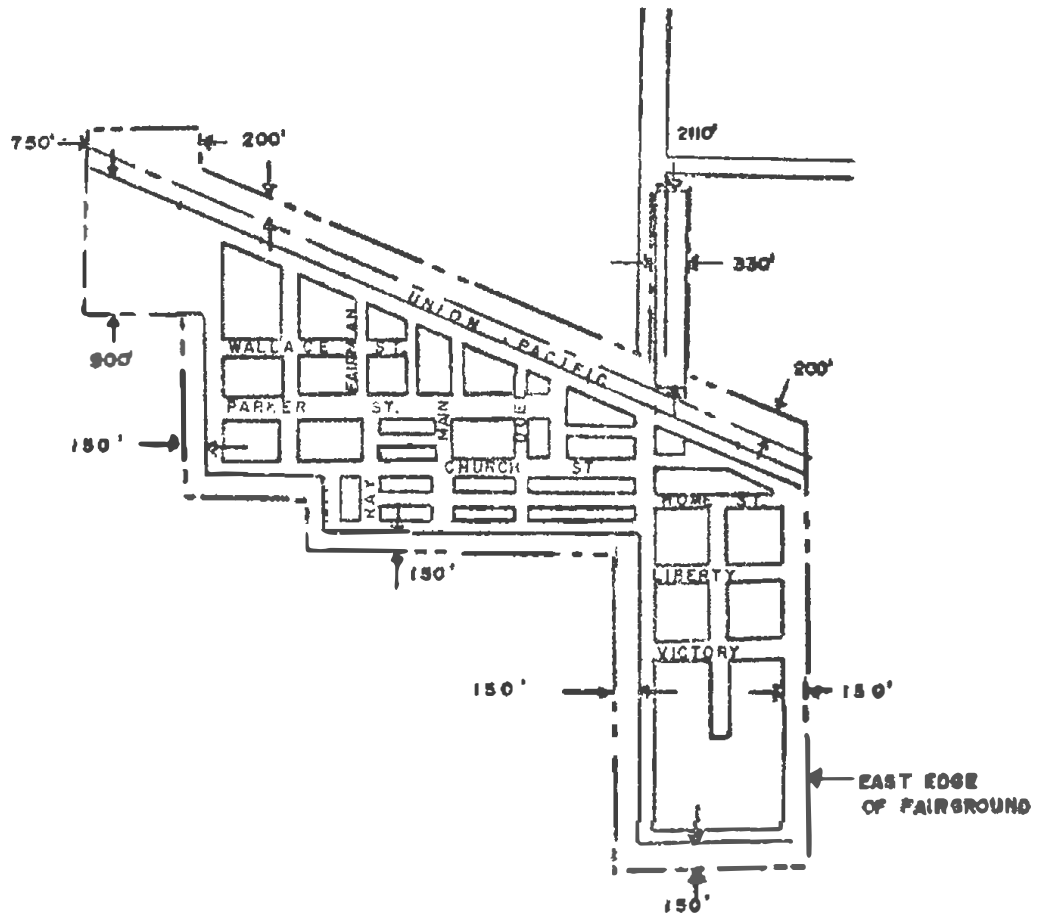

Issued: August 7, 1979

Effective: January 6, 1980

By DAVID C. BAKER
 Vice President & General Manager

THE UNITED TELEPHONE COMPANY
OF THE WEST
LOCAL EXCHANGE TARIFF
NEBRASKA

ZONE
BOUNDARY
MAP

RECEIVED
DEC 1-8 1981
ACCT. & ENGI. DEPARTMENT
Nebr. Public Service Commission

WELLEN - EXCHANGE

MAP NO. 5

EXCHANGE BOUNDARY
BASE RATE AREA
ZONE BOUNDARY

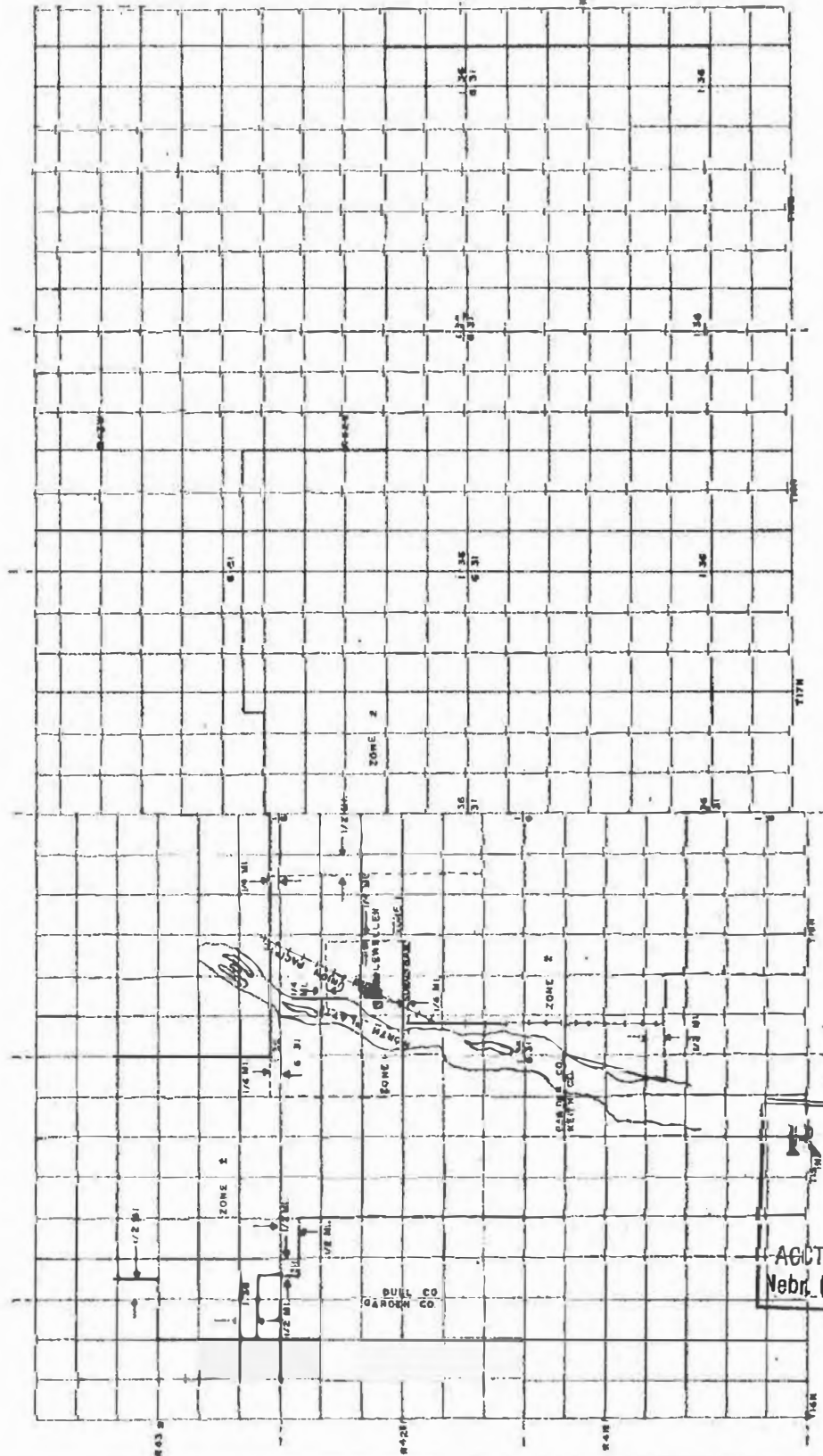

RECEIVED
DEC 1-8 1981
ACCT. & ENGI. DEPARTMENT
Nebr. Public Service Commission

ISSUED: NOVEMBER 17, 1981

EFFECTIVE:

NOVEMBER 19, 1981

BY R. M. GRAVES
VICE PRESIDENT

THE UNITED TELEPHONE COMPANY
OF THE WEST
LOCAL EXCHANGE TARIFF
NEBRASKA

EXCHANGE: LYMAN
First Revised Sheet 8M

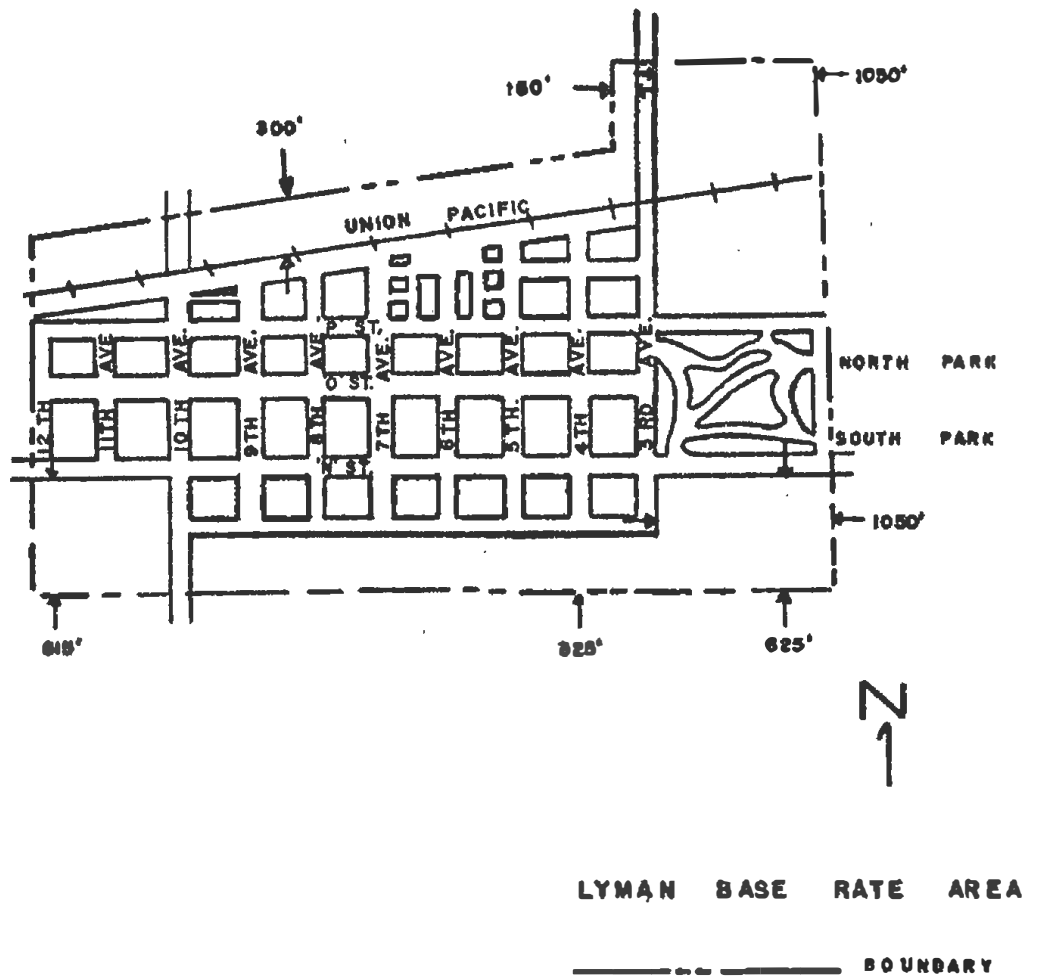

Issued: August 7, 1979

Effective: January 6, 1980

By DAVID C. BAKER
Vice President & General Manager

THE UNITED TELEPHONE COMPANY
OF THE WEST
LOCAL EXCHANGE TARIFF
NEBRASKA

RECEIVED
DEC 1-8 1981
ACCT. & ENGI. DEPARTMENT
Nebr. Public Service Commission

LYMAN - EXCHANGE
MAP NO. 5

ZONE
BOUNDARY
MAP

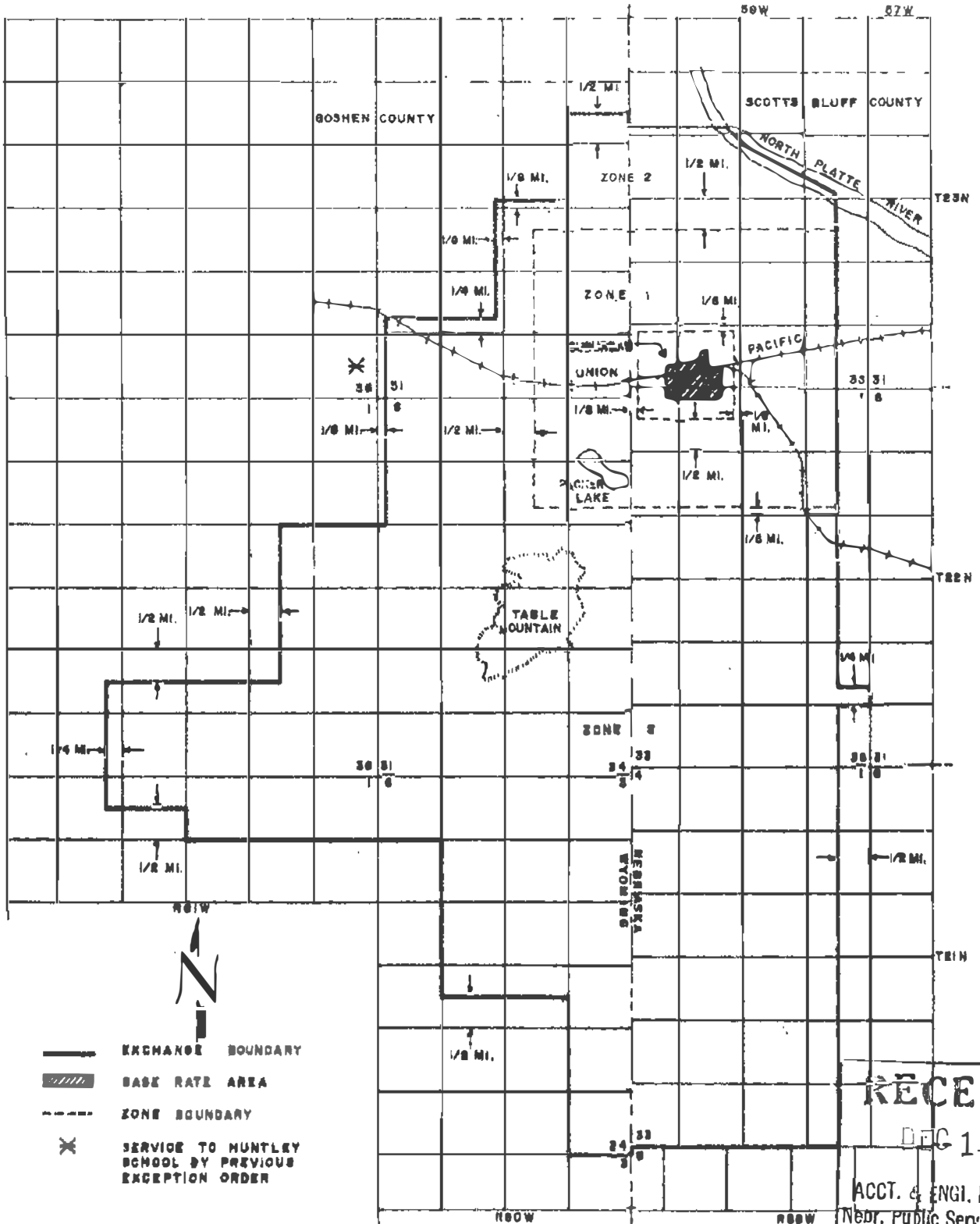

RECEIVED
DEC 1-8 1981
ACCT. & ENGI. DEPARTMENT
Nebr. Public Service Commission

ISSUED: NOVEMBER 17, 1981

EFFECTIVE:

NOVEMBER 19, 1981

BY R. M. GRAVES
VICE PRESIDENT

LOCAL EXCHANGE TARIFF

UNITED TELEPHONE COMPANY
OF THE WEST
NEBRASKA

Gering Exchange
Map No. - 6

EXCHANGE BOUNDARY MAP
GERING - TOTAL EXCHANGE

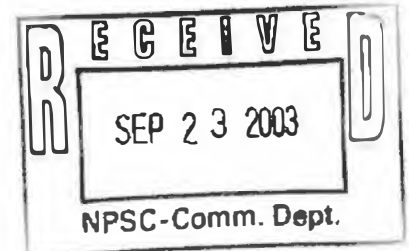
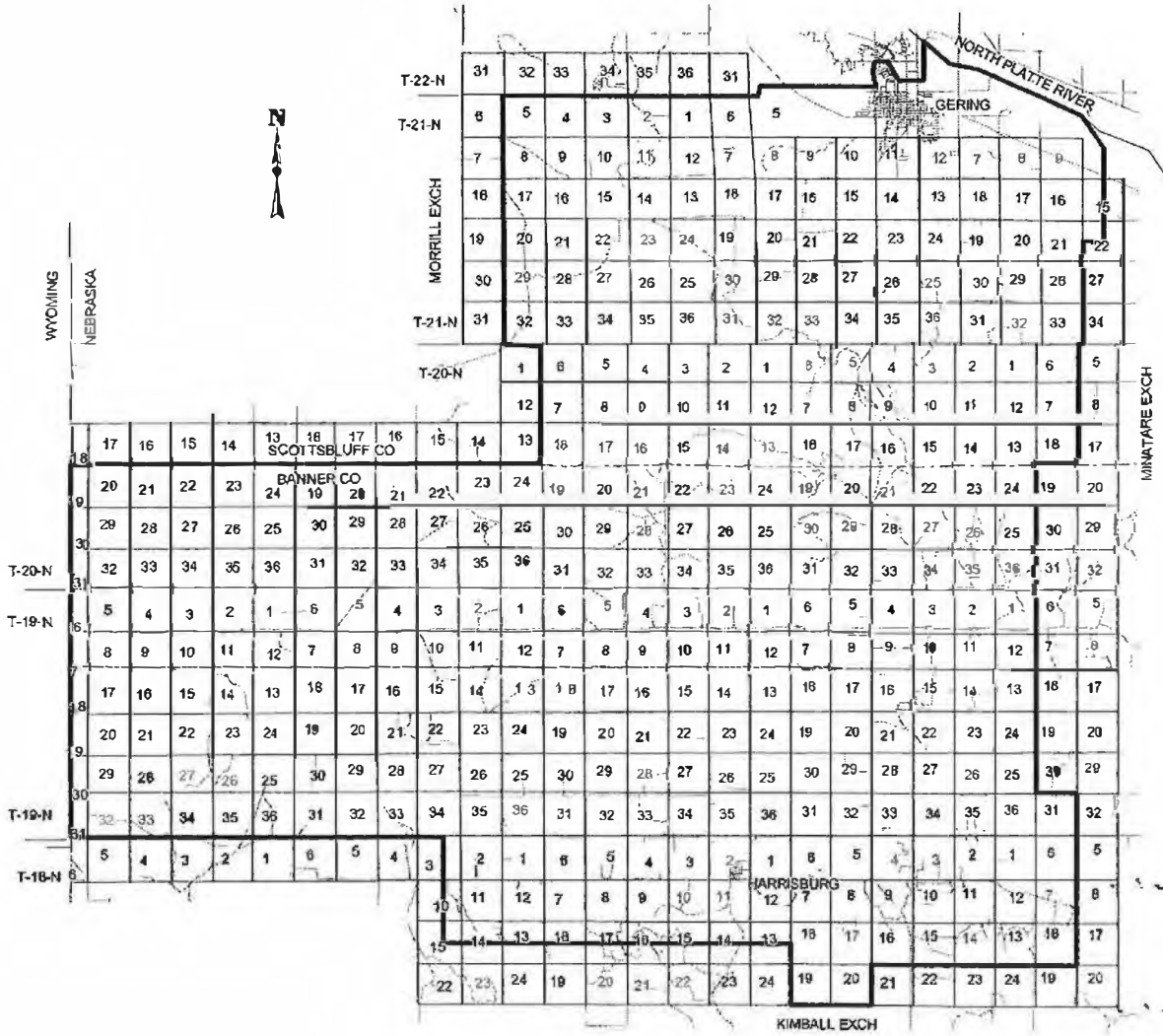

ISSUED:
September 23, 2003

BY: Warren D. Hannah
Director, Tariffs

EFFECTIVE:
October 2, 2003

THE UNITED TELEPHONE COMPANY
OF THE WEST
LOCAL EXCHANGE TARIFF
NEBRASKA

EXCHANGE: MINATARE

First Revised Sheet 9M

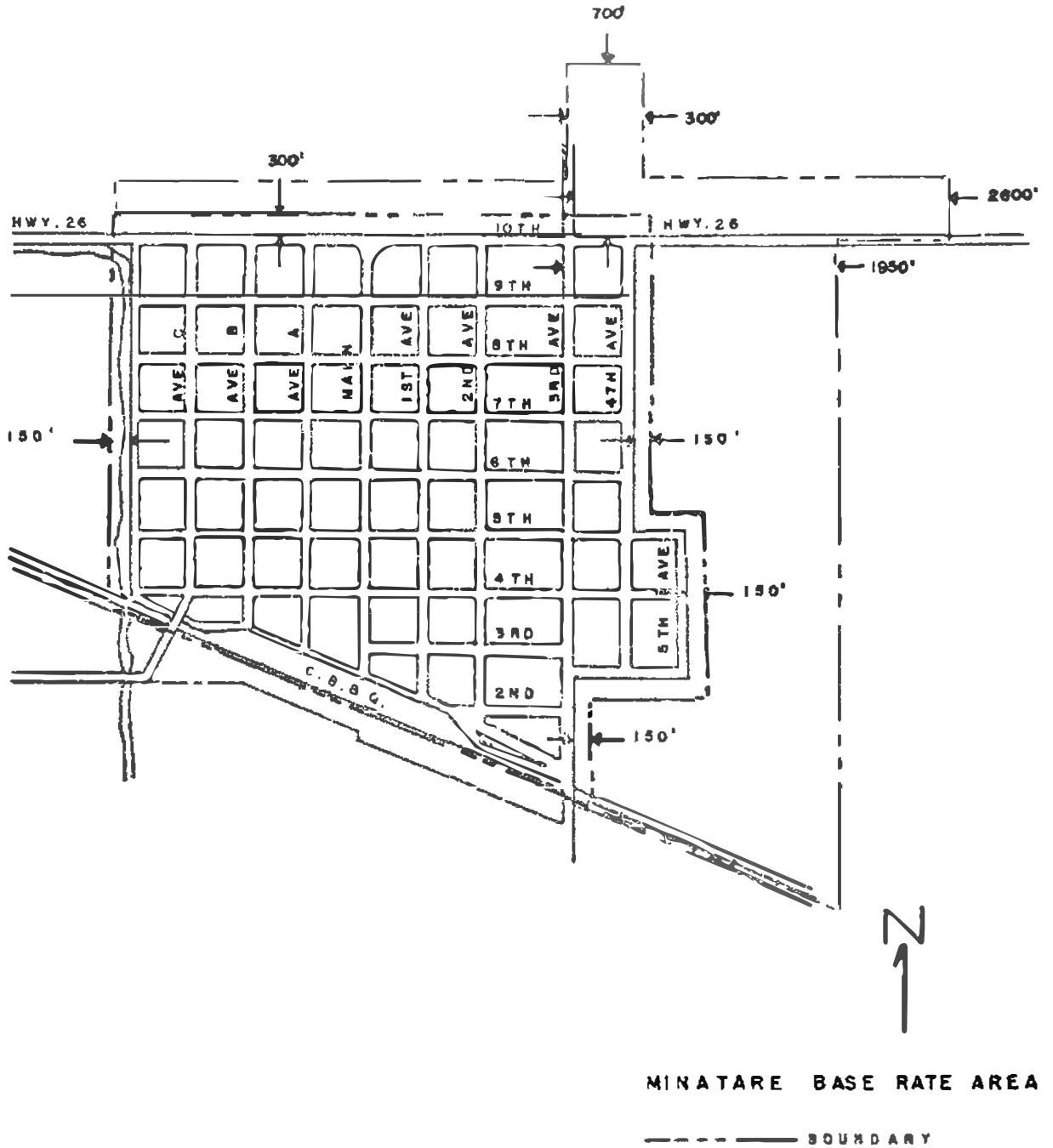

Issued: August 7, 1979

Effective: January 6, 1980

By DAVID C. BAKER
Vice President & General Manager

THE UNITED TELEPHONE COMPANY
OF THE WEST
LOCAL EXCHANGE TARIFF
NEBRASKA

ZONE
BOUNDARY
MAP

RECEIVED
DEC 18 1981
ACCT. & ENGI. DEPARTMENT
Nebr. Public Service Commission

WATAME - EXCHANGE

MAP NO. 7



EXCHANGE BOUNDARY
BASE RATE AREA
ZONE BOUNDARY

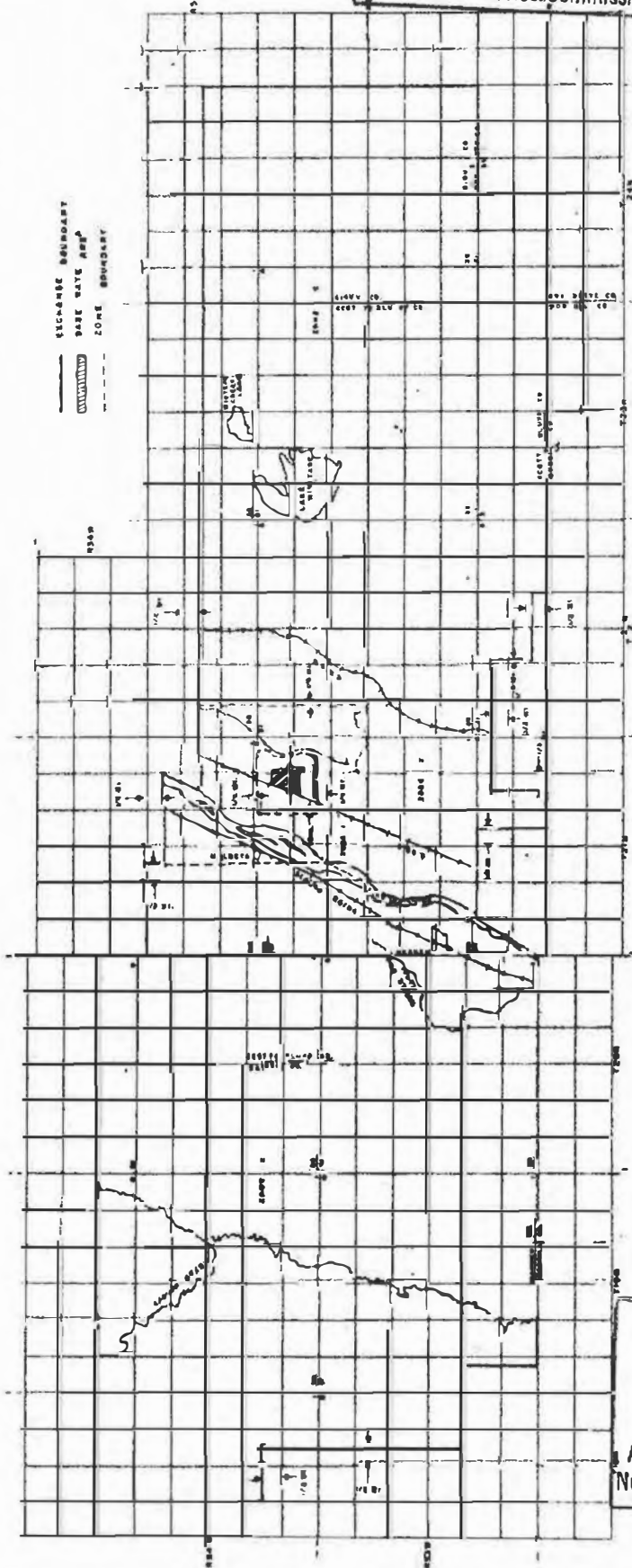

RECEIVED
DEC 18 1981
ACCT. & ENGI. DEPARTMENT
Nebr. Public Service Commission

ISSUED: NOVEMBER 17, 1981

EFFECTIVE: NOVEMBER 19, 1981

BY R. M. GRAVES
VICE PRESIDENT

THE UNITED TELEPHONE COMPANY
OF THE WEST
LOCAL EXCHANGE TARIFF
NEBRASKA

EXCHANGE: MITCHELL
Second Revised Sheet 10M

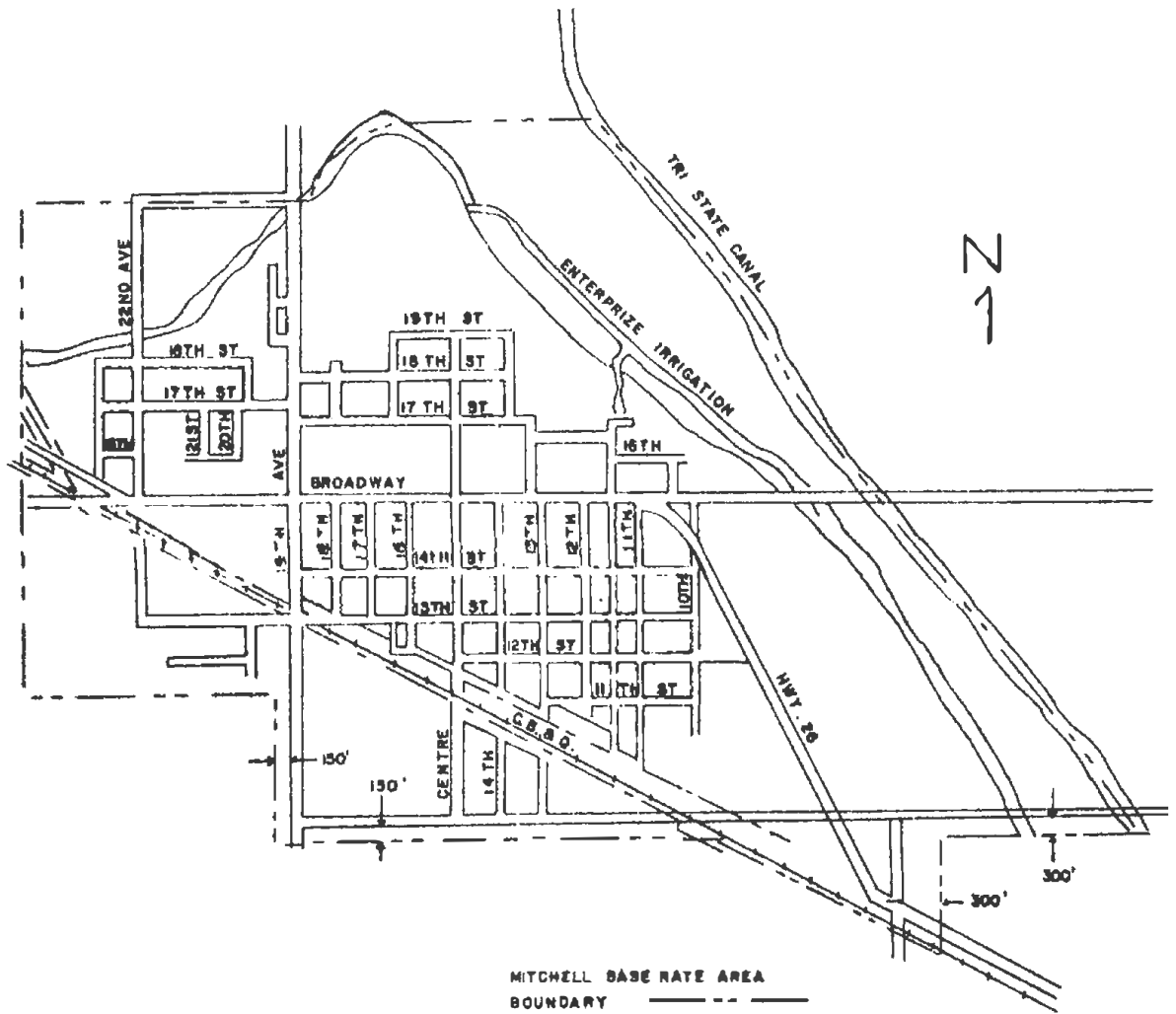

Issued: August 7, 1979

Effective: January 6, 1980

By DAVID C. BAKER
Vice President & General Manager

THE UNITED TELEPHONE COMPANY
OF THE WEST
LOCAL EXCHANGE TARIFF
NEBRASKA

ZONE
BOUNDARY
MAP

DEC 1-8 1981 MITCHELL - EXCHANGE
ACCT. & ENGI. DEPARTMENT
Nebr. Public Service Commission
MAP NO. 6

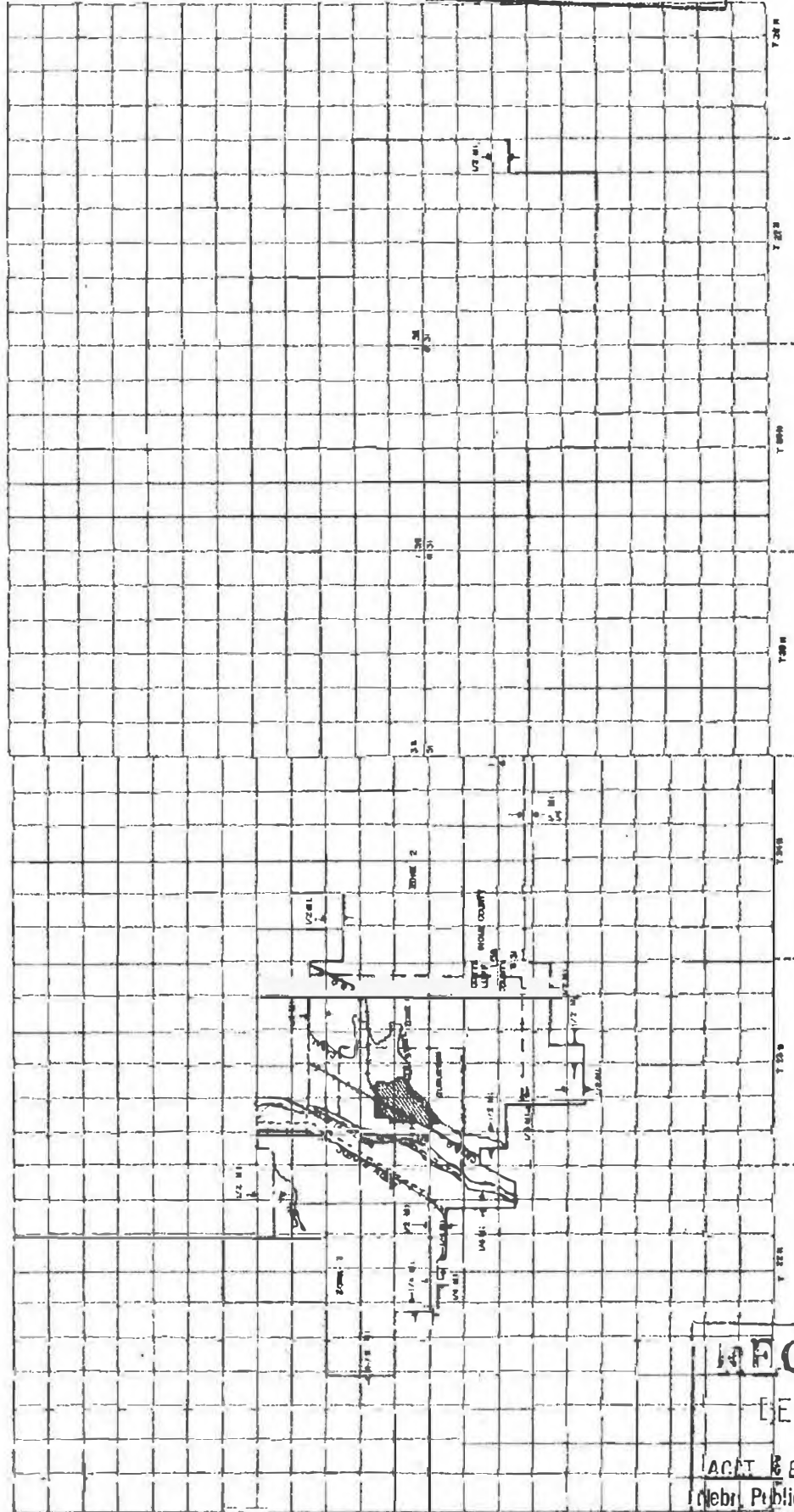

EXCHANGE BOUNDARY
RATE AREA
ZONE BOUNDARY

RECEIVED
DEC 1-8 1981
ACCT. & ENGI. DEPARTMENT
Nebr. Public Service Commission

ISSUED: NOVEMBER 17, 1981

EFFECTIVE:

NOVEMBER 19, 1981

BY R. M. GRAVES
VICE PRESIDENT

THE UNITED TELEPHONE COMPANY
 OF THE WEST
 LOCAL EXCHANGE TARIFF
 NEBRASKA

EXCHANGE: MORRILL
 First Revised Sheet 11M

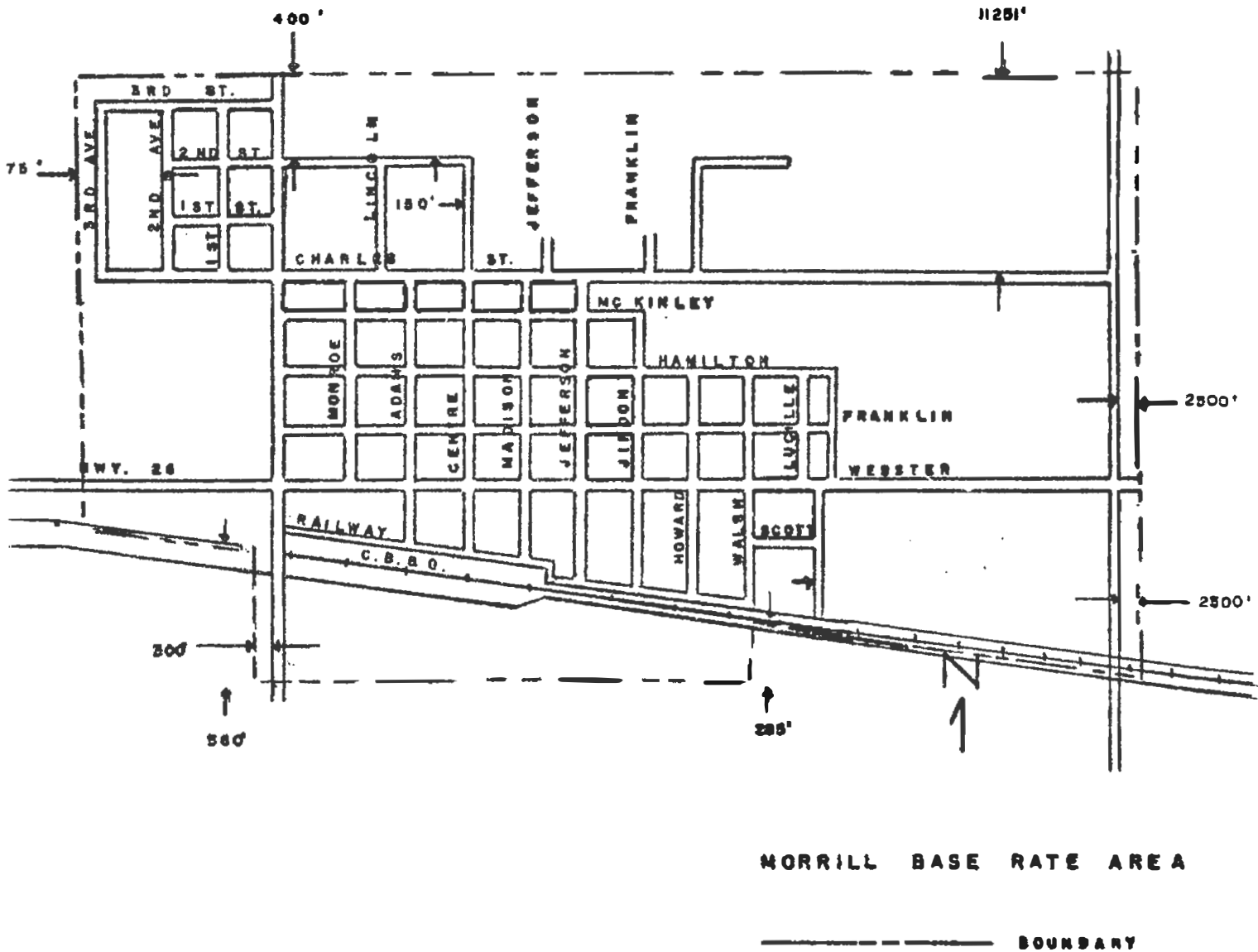

RECEIVED
DEC 1-8 1981
ACCT. & ENGI. DEPARTMENT
Nebr. Public Service Commission

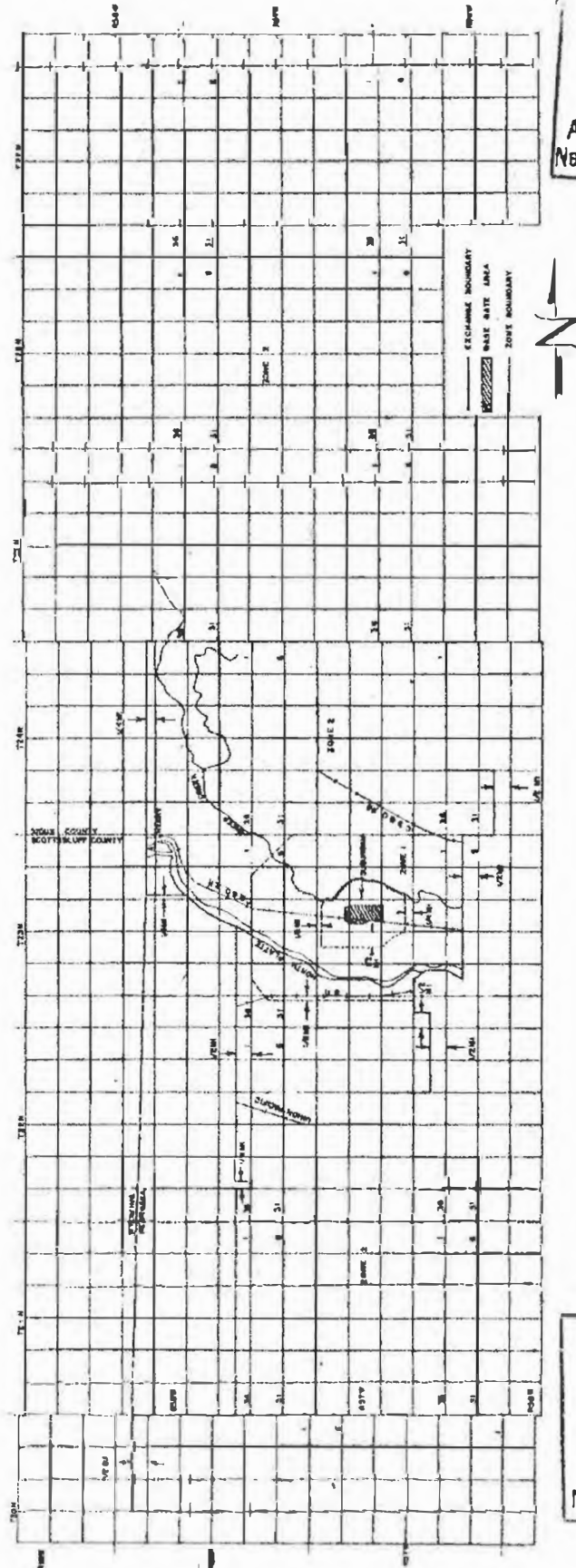

RECEIVED
DEC 1-8 1981
ACCT. & ENGI. DEPARTMENT
Nebr. Public Service Commission

THE UNITED TELEPHONE COMPANY
OF THE WEST
LOCAL EXCHANGE TARIFF
NEBRASKA

EXCHANGE: OSHKOSH
First Revised Sheet 12M

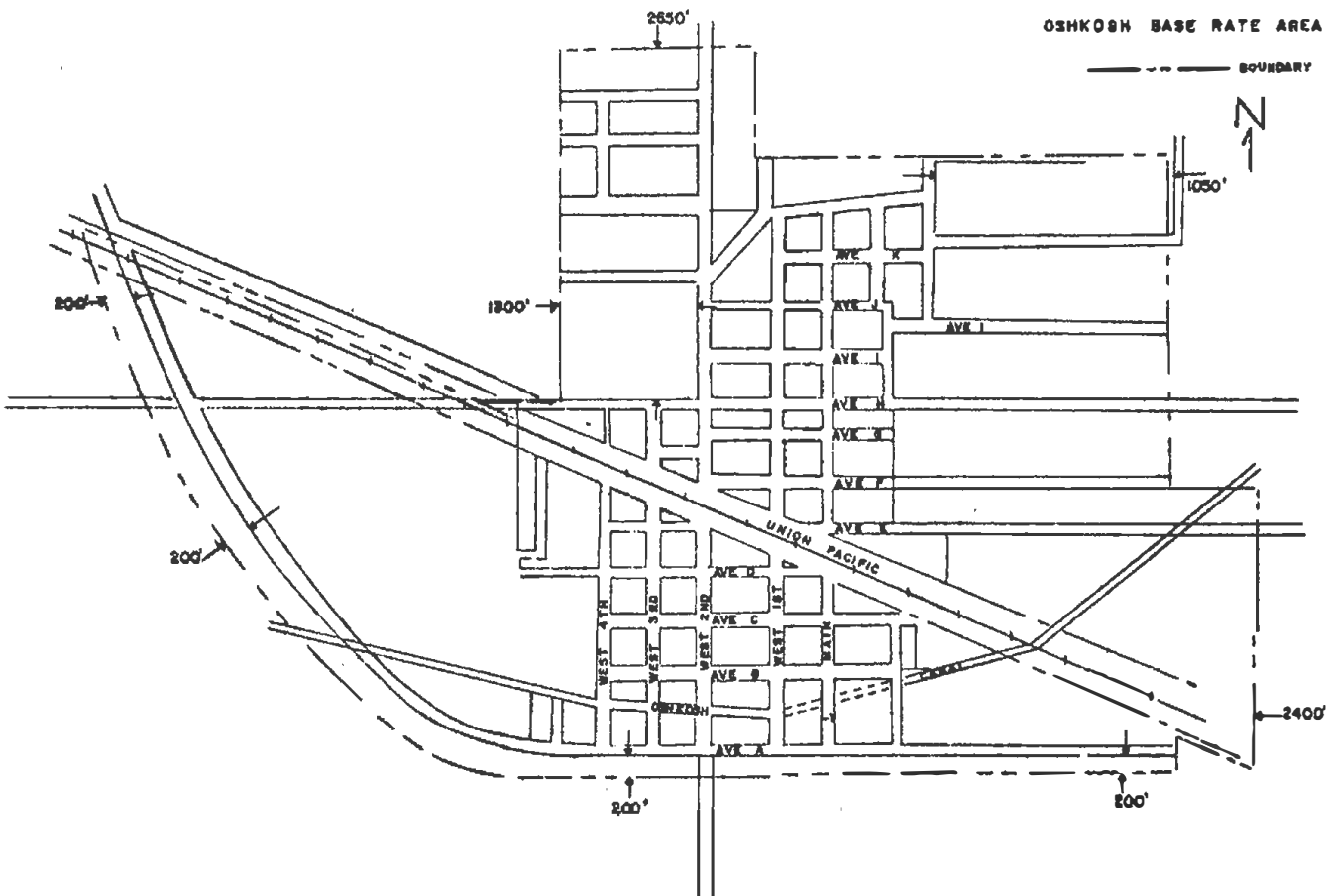

Issued: August 7, 1979

Effective: January 6, 1980

By DAVID C. BAKER
Vice President & General Manager

THE UNITED TELEPHONE COMPANY
OF THE WEST
LOCAL EXCHANGE TARIFF
NEBRASKA

OSHKOSH EXCHANGE

MAP NO. 5

RECEIVED
DEC 18 1981
ACCT. & ENGI. DEPARTMENT
Nebr. Public Service Commission

ZONE
BOUNDARY
MAP

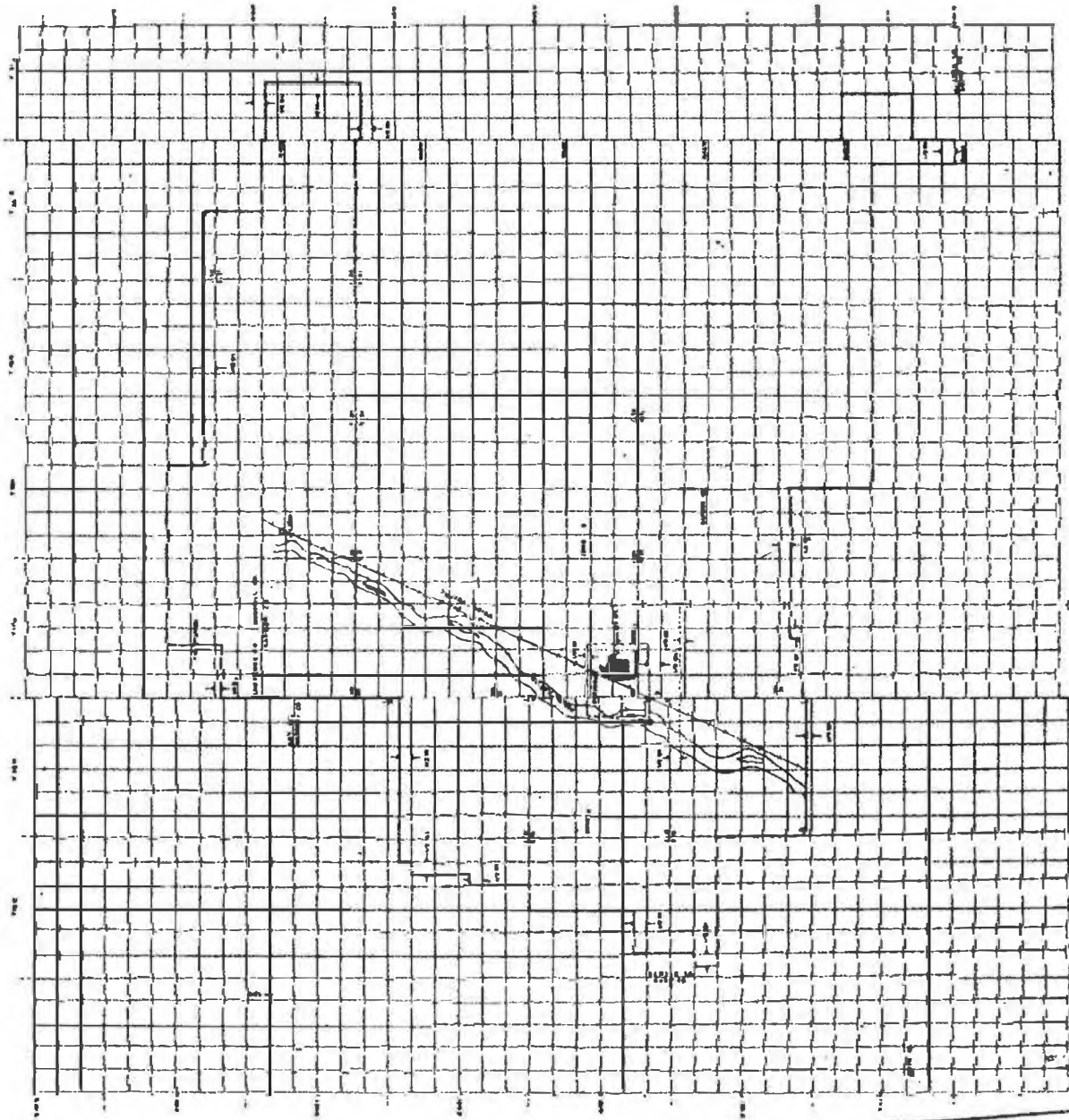

RECEIVED
DEC 18 1981
ACCT. & ENGI. DEPARTMENT
Nebr. Public Service Commission

ISSUED: NOVEMBER 17, 1981

EFFECTIVE: NOVEMBER 19, 1981

BY R. M. GRAVES
VICE PRESIDENT

THE UNITED TELEPHONE COMPANY
 OF THE WEST
 LOCAL EXCHANGE TARIFF
 NEBRASKA

EXCHANGE: POTTER
 First Revised Sheet 15M

POTTER BASE RATE AREA
 ----- BOUNDARY

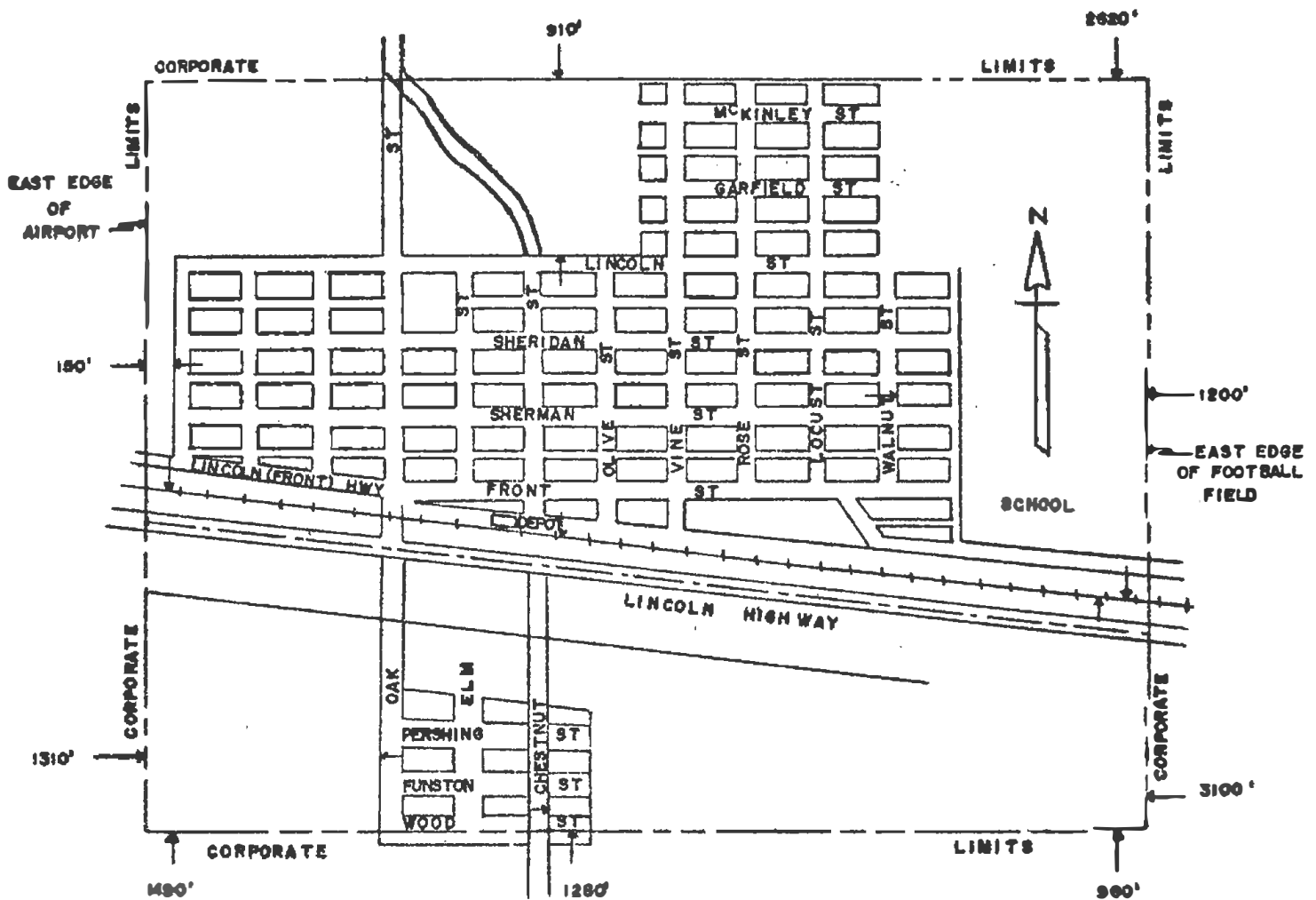

Issued: August 7, 1979

Effective: January 6, 1980

By DAVID C. BAKER
 Vice President & General Manager

ZONE
BOUNDARY
MAP

RECEIVED
DEC 18 1981
ACCT. & ENGI. DEPARTMENT
Nebr. Public Service Commission

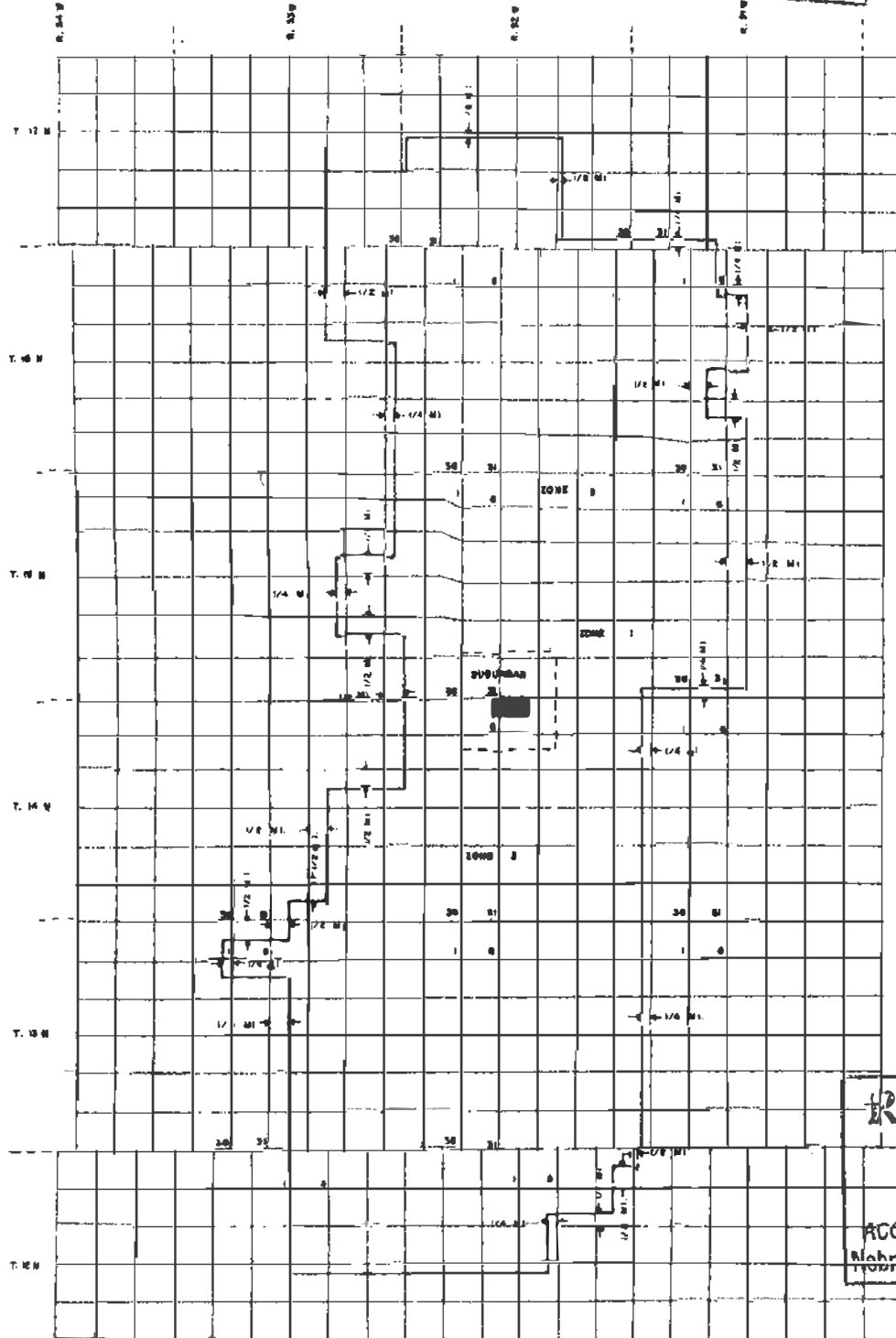

EXCHANGE BOUNDARY
BASE RATE AREA
ZONE BOUNDARY

RECEIVED
DEC 18 1981
ACCT. & ENGI. DEPARTMENT
Nebr. Public Service Commission

THE UNITED TELEPHONE COMPANY
 OF THE WEST
 LOCAL EXCHANGE TARIFF
 NEBRASKA

EXCHANGE: SCOTTSBLUFF

Third Revised Sheet 13M

SCOTTSBLUFF BASE RATE AREA

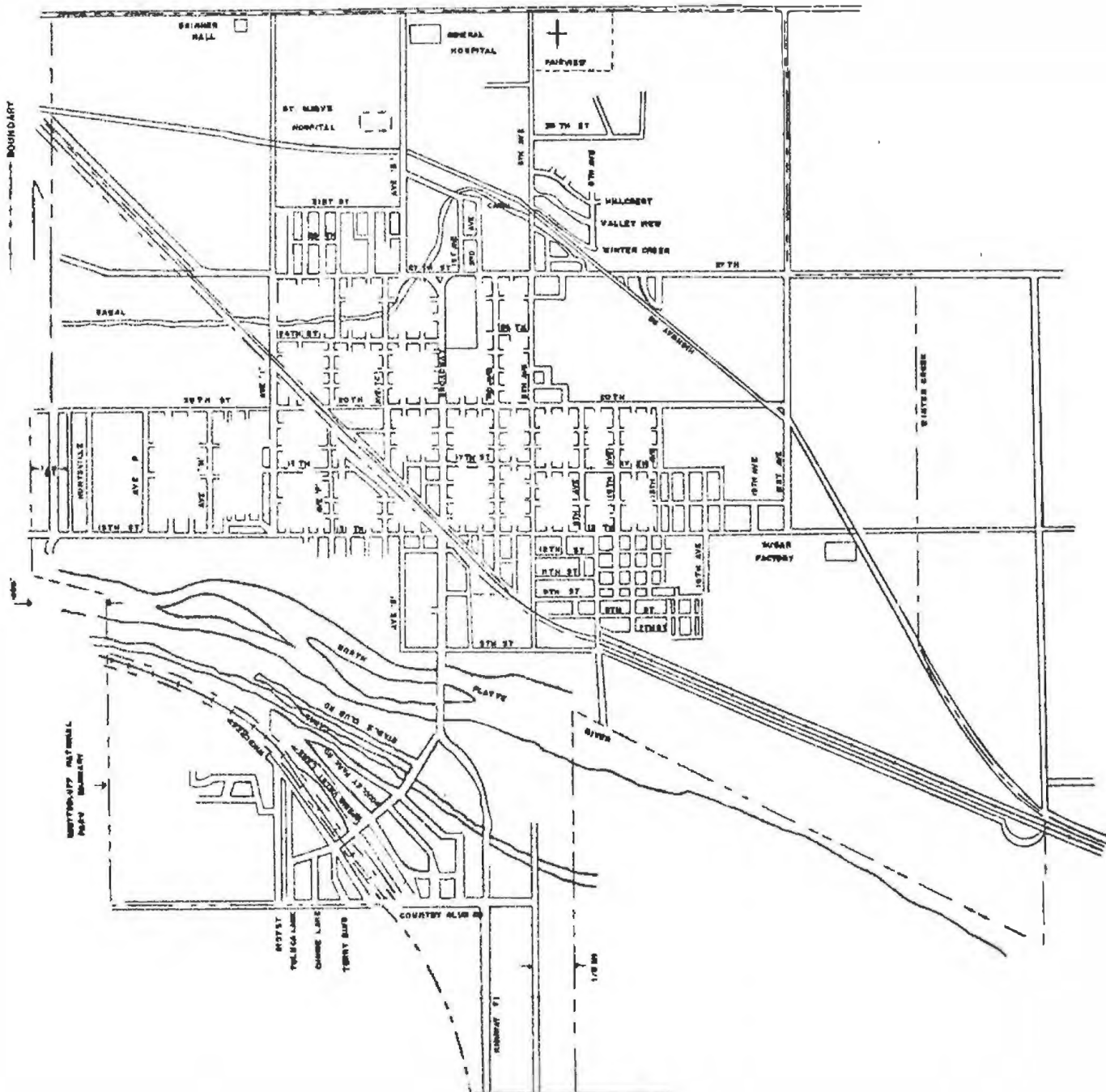

Issued: August 7, 1979

Effective: January 6, 1980

By DAVID C. BAKER
 Vice President & General Manager

THE UNITED TELEPHONE COMPANY
OF THE WEST
LOCAL EXCHANGE TARIFF
NEBRASKA

SCOTTSBLUFF - EXCHANGE

ZONE
BOUNDARY
MAP

MAP NO. 6

RECEIVED

DEC 18 1981

ACCT. & ENGI. DEPARTMENT
Nebr. Public Service Commission

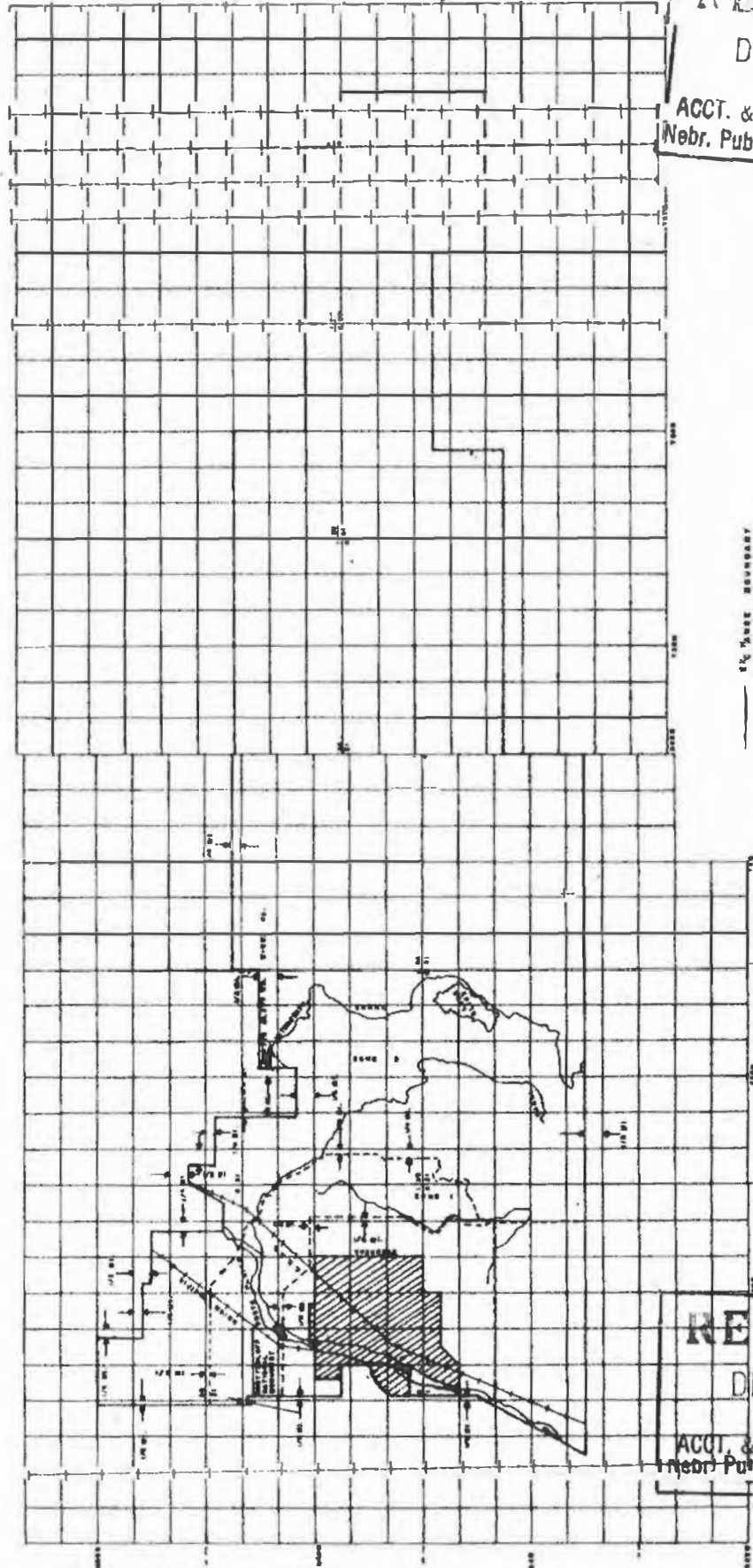

— Zone Boundary
- - - Rate Area Boundary
... Rate Boundary

RECEIVED

DEC 18 1981

ACCT. & ENGI. DEPARTMENT
Nebr. Public Service Commission

ISSUED: NOVEMBER 17, 1981

EFFECTIVE:

NOVEMBER 19, 1981

BY R. M. GRAVES
VICE PRESIDENT

GENERAL EXCHANGE TARIFF

UNITED TELEPHONE COMPANY
 OF THE WEST d/b/a CenturyLink
 NEBRASKA

Table of Contents
 Twenty-Eighth Revised Sheet 1
 Cancels Twenty- Seventh Revised Sheet 1

TABLE OF CONTENTS

<u>Subject</u>	<u>Section</u>	
General Rules and Regulations	GRR	(T)
Payment Of Bills, Advance Payments and Deposits	1	(T)
Application of Rates for Business and Residence Service and Combined Main Station Service.....	2	
Construction Charges and Other Special Charges.....	3	
Directory Listings.....	4	
Reserved for Future Use.....	5	
Reserved for Future Use.....	6	
Initial Service Periods and Termination of Service	7	
Mileage Charges	8	
Lifeline Assistance Programs.....	9	
Reserved for Future Use.....	10	
Returned Check Charge	11	
Reserved for Future Use.....	12	
Restoration of Service	13	
Reserved for Future Use.....	14	
Payphone Line Service	15	
Bridged Main Station Service.....	16	
Reserved for Future Use.....	17	
Service Connection Charges	18	
N11 Service.....	19	
Suspension of Service	20	
Public Emergency Reporting Service	21	
Reserved for Future Use.....	22	
Connections with Certain Facilities of Customers.....	23	
Reserved for Future Use.....	24	
Foreign Exchange Service (Business Only)	25	
Reserved for Future Use.....	26	
Private Line Service and Channels.....	27	
Reserved for Future Use.....	28	
Long Distance Message Telecommunications Service	29	
Reserved for Future Use.....	30	
Service through Miscellaneous Common Carriers	31	
Operator Services	32	
Reserved for Future Use.....	40	

ISSUED:
 December 29, 2022

BY: Terri Million
 Director, Tariffs

EFFECTIVE:
 January 10, 2023

NE2023-01

Received by NPSC
 12/28/2022

GENERAL EXCHANGE TARIFF

UNITED TELEPHONE COMPANY
OF THE WEST
NEBRASKA

Table of Contents
First Revised Sheet 2
Cancels Original Sheet 2

TABLE OF CONTENTS

Explanation of Symbols

- (C) - Designates change listing, rule or condition which may affect rates or charges.
- (D) - Designates discontinued material including any listing, rate, rule or condition.
- (I) - Designates an increase in the rate.
- (M) - Designates material relocated from or to another part of tariff schedules with no change in text, rate, rule or condition. (T)
- (N) - Designates new material including a listing, rate, rule or condition.
- (R) - Designates a reduction in the rate.
- (T) - Designates a change in the text with no change in the rate, rule or condition.
- (Z) - **Designates a correction.** (N)

ISSUED:
June 16, 2009

BY: Darlene Terry
Manager - Tariffs

~~JUN 16 2009~~

EFFECTIVE:
June 26, 2009

NPSC-Comm. Dept.

GENERAL EXCHANGE TARIFF

UNITED TELEPHONE COMPANY
OF THE WEST d/b/a CenturyLink
NEBRASKA

Table of Contents
Third Revised Sheet 3
Cancels Second Revised Sheet 3

TABLE OF CONTENTS

Trade Names, Trademarks and Service Marks Used in this Tariff

Below is a list of trade names, trademarks and/or service marks for services which are offered in this Tariff. These trade names, trademarks and/or service marks are owned by **Lumen Technologies, Inc.** (formerly CenturyLink, Inc.) or a subsidiary of **Lumen Technologies, Inc.** and are used by the Company with express permission. Trademark and service mark designations will not be listed hereafter in the Tariff. However, the laws regarding trade names, trademarks and service marks will still apply. Trade names, trademarks and service marks that are owned by **Lumen Technologies, Inc.** or a subsidiary of **Lumen Technologies, Inc.** cannot be used by another party without authorization.

CENTURYLINK (C)
CENTURYLINK® (C)
(D)

ISSUED:
May 20, 2021

BY: Darlene Terry
Director, Tariffs

EFFECTIVE:
July 1, 2021

NE 2021-13

Received by NPSC
05/19/2021

GENERAL EXCHANGE TARIFF

UNITED TELEPHONE COMPANY
OF THE WEST d/b/a CenturyLink
NEBRASKA

GENERAL INDEX
Thirty-First Revised Sheet 1
Cancels Thirtieth Revised Sheet 1

	<u>SECTION</u>	<u>SHEET</u>	
211 Service for Information and Referral Service	19	25	
311 Non-Emergency Service	19	17	
511 Service for Travel Information Services	19	32	
711 Service for Telecommunications Relay Services (TRS)	19	11	
811 Service For "One Call" Notification Systems.....	19	40	
911 Services	19	1	
Accessories - Customer Provided.....	23	8	
Advanced Payments	1	1	
Alarm Detection & Reporting Equipment - Customer-Provided	23	13	
Answer Supervision	15	4.1	
Application of Rates for Business & Residence Service.....	2	1	
Audible Indicating Equipment - Customer-Provided	23	15	
Automatic Answering & Recording Equip. - Customer-Provided	23	17.2	
Auxiliary Listings	4	8	
Bridged Main Station Service.....	16	1	
Business Service Rates	2	1	
Coin Control	15	4	
Combined Access Line Service	2	1	
Communications Systems - Customer-Provided	23	10	
Complete Disconnection	13	1	
Connection of F.C.C. Registered Equipment.....	23	9	
Connections with Certain Facilities of Customers	23	1	
Construction Charges and Other Special Charges	3	1	(C)
			(D)
			(D)
Customer Owned Coin Telephone Service.....	15	4	
Data Transmitting and/or Receiving Equipment - Customer-Provided	23	2b	
Deposits	1	1	
Direct Electrical Connection	23	9	
Directory Assistance	32	1	
Directory Listings	4	1	
Dual-Name Listings.....	4	7	
Extension of Facilities	3	1	(N)
Federal Aviation Agency Provided Systems	23	12	
Foreign Exchange Service (Business Only)	25	1	

ISSUED:
May 22, 2020

BY: Darlene Terry
Manager, Tariffs

EFFECTIVE:
June 1, 2020

NE2020-04

Received by NPSC
05/22/2020

GENERAL EXCHANGE TARIFF

UNITED TELEPHONE COMPANY
OF THE WEST d/b/a CenturyLink
NEBRASKA

GENERAL INDEX
Twenty-Ninth Revised Sheet 2
Cancels Twenty- Eighth Revised Sheet 2

	<u>SECTION</u>	<u>SHEET</u>	
Initial Service Periods.....	7	1	
Lifeline Assistance	9	1	
Link Services	28	1	
Long Distance Message Telecommunications Service	29	1	
Low-Income Connection Assistance (Service Connection Charges)	18	11	
Mileage Charges	8	1	
N11 Service.....	19	1	
National Aeronautics & Space Administration Provided Facilities.....	23	12	
Natural Disaster Relief for Customers	GRR	9	
Network Protection Criteria	23	20	
Operator Intercept Services	32	4	
Operator Services	32	1	
Optional Local Measured Service	LET	2.1	
Paper Bill Fee	1	2	(N)
Payphone Line Service	15	4	
Pipe Line Company Provided Facilities	23	12	
Power Company Provided Facilities	23	12	
Primary Listings.....	4	2	
Private Line Service	27	1	
Provisioning Agreement for Housing Developments	3	1	
Public Emergency Reporting Service	21	1	
Railroad Company Provided Facilities	23	12	
Recorder-Connector for Customer-Provided Equipment.....	23	16a	
Residence Service for Company Employees.....	GRR	8	
Residence Service Rates.....	2	1	

ISSUED:
December 29, 2022

BY: Terri Million
Director, Tariffs

EFFECTIVE:
January 10, 2023

NE3071-00

Received by NPSC
12/28/2022

GENERAL EXCHANGE TARIFF

UNITED TELEPHONE COMPANY
OF THE WEST d/b/a CenturyLink
NEBRASKA

GENERAL INDEX
Twenty-Third Revised Sheet 3
Cancels Twenty- Second Revised Sheet 3

	<u>SECTION</u>	<u>SHEET</u>	
Restoration of Service	13	1	
Returned Check Charge	11	1	
School and Library Discounts.....	GRR	4	
Service Connection Charges	18	1	
Special Types of Construction	3	1	(D)
Specialty Telephones - Customer-Provided	23	19	(D)
Suspension of Service	20	1	(T)
Temporary Suspension of Service for Non-Payment	13	1	(D)
Terminal Equipment - Customer-Provided.....	23	2	
Termination of Service	7	1	
Tie Lines (P.B.X.).....	8	1	
Trademarks and Service Marks	TOC	3	
Trunk Lines (P.B.X.).....	LET	1	
U.S. Air Force Provided Facilities	23	11	
U.S. Army Provided Facilities.....	23	11	
U.S. Army National Guard Provided Facilities	23	12	
U.S. Coast Guard Provided Facilities	23	12	
U.S. Government Executive Departments and Agencies Provided Equipment.....	23	12	
U.S. Navy Provided Facilities.....	23	11	
Vanity Listings	4	9	
Voice Recording Equipment - Customer-Provided	23	16a	
Voice Transmitting and/or Receiving Equipment - Customer-Provided	23	6b	
Waiver of Installation and/or Service Connection Charges	GRR	8	

ISSUED:
May 22, 2020

BY: Darlene Terry
Manager, Tariffs

EFFECTIVE:
June 1, 2020

NE2020-04

Received by NPSC
05/22/2020

Attachment A

List of Pages:

Section 2	Page 2	Release 12	Section 12 (Cont'd)	Page 1.3	Release 2
	Page 2.1	Release 12		Page 2	Release 7
	Page 2.2	Release 8		Page 3	Release 8
	Page 2.3	Release 10		Page 4	Release 8
	Page 2.4	Release 7		Page 6	Release 5
	Page 4	Release 15		Page 7	Release 4
	Page 4.01	Release 1		Page 8	Release 3
	Page 4.1	Release 11		Page 12	Release 11
	Page 4.2	Release 6		Page 13	Release 10
	Page 15	Release 4		Page 15	Release 12
Section 3	Page 2	Release 5		Page 15.1	Release 8
Section 12	Page 1	Release 8		Page 16	Release 3
	Page 1.01	Release 3			

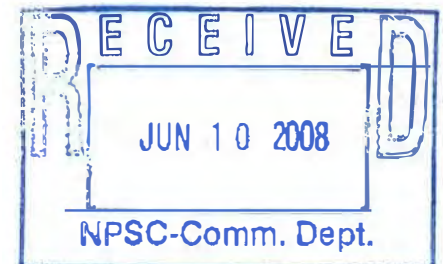

GENERAL EXCHANGE TARIFF

UNITED TELEPHONE COMPANY
OF THE WEST
NEBRASKA

Fifth Revised Sheet 1
Cancels Fourth Revised Sheet 1

GENERAL RULES AND REGULATIONS APPLYING TO TELEPHONE SERVICE

SCOPE - The rules and regulations specified herein are in addition to the rules and regulations contained in other sections of the General Exchange Tariff, or in the Local Exchange Tariffs.

ALLOWANCE FOR FAILURE OF SERVICE - In view of the possibility of errors and difficulties in the transmission of messages by telephone and the impossibility of fixing in all cases the causes thereof, the subscriber assumes all risks connected with the service, as the Telephone Company cannot guarantee uninterrupted working of its lines. In case service is interrupted in excess of twenty-four hours after being reported or found to be interrupted, otherwise than by the negligence or willful act of the subscriber, a pro rata allowance is made, computed on the basis of the minimum monthly rate for such of the telephone service and facilities furnished that are rendered useless or inoperative. Provided, however, if service is interrupted as the result of widespread disaster, and otherwise than by the negligence or willful act of the Telephone Company, no refund shall be required unless the service remains interrupted for a period in excess of seven days. Such allowance is made for the period of interruption after notice in writing is received by the Telephone Company and may be accomplished by a credit on a subsequent bill for telephone service. No other liability shall in any case be attached to the Telephone Company.

The Telephone Company will make reasonable efforts to cure any material failure to provide service caused solely by year 2000 defects in Telephone Company hardware, software or systems. Due to the interdependence among telecommunications providers and the interrelationship with non-Telephone Company processes, equipment and systems, the Telephone Company is not responsible for failures caused by circumstances beyond its control, including, but not limited to, failures caused by: 1) the Customer; 2) other telecommunications providers; or 3) customer premises equipment. In addition, the Telephone Company does not ensure compatibility between Telephone Company and non-Telephone Company services used by the Customer.

(N)

(N)

CHANGE OF TELEPHONE NUMBER - The subscriber has no property right in the telephone number or any right to continuance of service through any certain central office and the Telephone Company may change the telephone number or the central office designation whenever it deems it desirable in the conduct of its business.

ISSUED:
April 16, 1999

BY: Warren D. Hannah
Director, Local Tariffs

EFFECTIVE:
May 17, 1999

GENERAL EXCHANGE TARIFF

UNITED TELEPHONE COMPANY
OF THE WEST d/b/a CenturyLink
NEBRASKA

Second Revised Sheet 1A
Cancels First Revised Sheet 1A

GENERAL RULES AND REGULATIONS APPLYING TO TELEPHONE SERVICE

UNAUTHORIZED ATTACHMENTS OR CONNECTIONS - No equipment, apparatus, circuit or device shall be attached to or connected with the facilities furnished by the Telephone Company, whether physically, by induction or otherwise, except as provided in this Tariff. In case such unauthorized attachment or connection is made, the Telephone Company shall have the right to disconnect the same; or to suspend the service during the continuance of said attachments or connections; or to terminate the service.

UNAUTHORIZED ACCESS AND HACKING - Except for physical damage to Customer's transmission facilities or Customer premise equipment directly caused by the Company's negligence or willful misconduct, the Company is not responsible for unauthorized access to, or alteration, theft, or destruction of, Customer's equipment, data, programs or other information through accident, wrongful means or any other cause while such information is stored on or transmitted across Company-provided network facilities or Customer premise equipment. Customer is responsible for any Company service or usage charges resulting from any such unauthorized access, unless a tariff, schedule or other written agreement expressly states otherwise.

(N)

(N)

ISSUED:
March 26, 2010

BY: Darlene Terry
Manager, Tariffs

EFFECTIVE:
April 5, 2010

GENERAL EXCHANGE TARIFF

UNITED TELEPHONE COMPANY
OF THE WEST
NEBRASKA

Third Revised Sheet 2
Cancels Second Revised Sheet 2

GENERAL RULES AND REGULATIONS APPLYING TO TELEPHONE SERVICE

MISCELLANEOUS DEVICES PROVIDED BY THE CUSTOMER - The provisions of the paragraph entitled "UNAUTHORIZED ATTACHMENTS OR CONNECTIONS" preceding shall not be construed or applied to bar a customer from using devices which serve his convenience in his use of the facilities of the Telephone Company in the service for which they are furnished under this Tariff, provided any such device so used in the opinion of the Company would not endanger the safety of Telephone Company employees or the public; damage, require change in or alteration of, or involve direct electrical connection to (except as provided for elsewhere in this Tariff (especially in Section 23.B.5.) the facilities of the Telephone Company; or interfere with the proper functioning of such facilities; or impair the operation of the telephone system or otherwise injure the public in its use of the Telephone Company's services. (C) (C)

Except as otherwise provided in this Tariff, nothing herein shall be construed to permit the use of a recording device, or of a device to interconnect any line or channel of the Telephone Company with any other communication line or channel of the Company or of any other person.

DEFAACEMENT OF PREMISES - No liability shall be attached to the Telephone Company by reason of any defacement or damage to the subscriber's premises, resulting from the placing of the Company's facilities or interface device on such premises, or by the removal thereof, when such defacement or damage is not the result of negligence on the part of the Company or its employees. The Telephone Company shall not be liable for damage or statutory penalties in any case where a claim is not presented in writing within 45 days after the alleged delinquency occurs. (C)

DEFAULT OF PAYMENT OR OTHER VIOLATION OF REGULATIONS -

a. The subscriber shall pay monthly in advance or on demand all charges for exchange service and shall pay on demand all charges for toll service. The subscriber assumes responsibility for all charges for exchange service and toll messages originating at the subscriber's station, and for toll messages received at the subscriber's station on which the charges have been reversed with the consent of the person called. (C)

ISSUED:
December 1, 1987

BY: Warren D. Hannah
Director, Local Tariffs

EFFECTIVE:
January 1, 1988
Docket No. C-738

GENERAL EXCHANGE TARIFF

UNITED TELEPHONE COMPANY
OF THE WEST d/b/a CenturyLink
NEBRASKA

Eleventh Revised Sheet 2A
Cancels Tenth Revised Sheet 2A

GENERAL RULES AND REGULATIONS APPLYING TO TELEPHONE SERVICE

DEFAULT OF PAYMENT OR OTHER VIOLATION OF REGULATIONS - (Cont'd)

- b. If the entire amount billed is not received by the Company prior to the next billing date, a late payment charge of **\$16.00** or 5% of the entire unpaid balance, whichever is greater, will be assessed. (I)

If payment is received by the Company before the next bill date, but for technical or other reasons, the payment is not applied to the customer's account, the customer will not be liable for late charges assessed on the portion of the unpaid balance.

The late payment charge will not apply to any balance to which the charge was applied in a previous billing. Late charges will not apply to a final bill. Local, state and federal government accounts are exempt from late payment charges.

The late payment charge does not apply to unpaid balances associated with disputed amounts. Undisputed amounts on the same bill shall be subject to the late payment charge.

- c. All charges due by the subscriber are payable by the subscriber at the Telephone Company's Commercial Office or at any other agency duly authorized to receive such payments. If objection in writing is not received by the Telephone Company within 20 days after the bill is rendered, the amount shall be deemed correct and binding upon the subscriber. Failure to receive a bill does not exempt the subscriber from prompt payment of the account.
- d. The Telephone Company may either suspend service or terminate the subscriber's contract without suspension of service or, following a suspension of service, sever the connection and remove any of its facilities from the subscriber's premises upon:
- (1) Abandonment of the service.
 - (2) Failure of a customer to make suitable deposit required by Telephone Company as authorized by this Tariff.
 - (3) Impersonation of another with fraudulent intent.

ISSUED:
May 20, 2022

BY: Darlene Terry
Manager, Tariffs

EFFECTIVE:
June 1, 2022

GENERAL EXCHANGE TARIFF

UNITED TELEPHONE COMPANY
OF THE WEST
NEBRASKA

Sixth Revised Sheet 3
Cancels Fifth Revised Sheet 3

GENERAL RULES AND REGULATIONS APPLYING TO TELEPHONE SERVICE

DEFAULT OF PAYMENT OR OTHER VIOLATION OF REGULATIONS (Cont'd)

- d. **The Telephone Company may either suspend ...** (Cont'd) (T)
- (5) Non-payment of any sum due for exchange, toll (excluding charges for 900, 960, and/or 976 calls) or other services.
 - (a) Lifeline subscribers will not be disconnected for non-payment of toll charges.
 - (6) Use of service in such a way as to impair or interfere with the service of other customers; such improper use includes, but is not limited to, the making of nuisance calls and the use of telephone service by a customer, or with his permission, in connection with a plan or contrivance to secure a large volume of telephone calls, to be directed to such customer at or about the same time resulting in preventing, obstructing, or delaying the telephone service of others.
 - (7) Any person who uses or permits the use of profane, obscene or grossly abusive language over or by means of the Company's facilities, and who, after reasonable notice, fails neglects or refuses to cease or refrain from such practice or to prevent the same.
 - (8) Any other violation of the Telephone Company's rules and regulations applying to subscriber's contracts or to the furnishing of service.
 - (9) Violation of Part 68 of the F.C.C. Rules and Regulations to connection of F.C.C. registered terminal equipment. Such violations may cause a temporary discontinuance of service. (See Section 23, Sheet 10).
- e. Should service be suspended for non-payment of charges, restoration of service will be made only as prescribed under "Restoration of Service."
- f. When service has been discontinued for non-payment, the contract is considered to have been terminated. Re-establishment of service may be made only upon the execution of a new contract.
- g. **Recovery of Collection Costs – Business** (N)
- Any Customer subscribing to Business services under this tariff (a "Business Customer") is responsible for all collections costs, including but not limited to attorney's fees, incurred by the Company in recovering any amounts due and owing to the Company by the Business Customer. In the event of the Business Customer's bankruptcy, the Company may assert its claim for collections costs and attorneys' fees under this tariff as a claim against the Business Customer's bankruptcy estate.** (N)

GENERAL EXCHANGE TARIFF

UNITED TELEPHONE COMPANY
OF THE WEST d/b/a CenturyLink
NEBRASKA

Second Revised Sheet 3A
Cancels First Revised Sheet 3A

GENERAL RULES AND REGULATIONS APPLYING TO TELEPHONE SERVICE

ERRORS IN DIRECTORY LISTINGS - The Telephone Company issues directories to assist it in furnishing prompt and convenient service, but it does not guarantee correct listings therein. The Telephone Company, except as provided herein, shall not be liable for damages arising out of errors in or omissions. The liability of the Telephone Company for damages caused to subscribers by errors in or omissions from its directories shall be limited to one-half the charges for the service affected for the period between the issuance of the directory in which such error or omission occurred and the publication of a new directory containing the proper listing.

The Telephone Company, in accepting listings as prescribed by applicants or subscribers, will not assume responsibility for the result of the publication of such listings in its directories, nor will the Telephone Company be a party of controversies arising between subscribers or others as a result of such publication.

INSTALLATION, RELOCATION AND MAINTENANCE OF FACILITIES AND LINES - Lines and facilities furnished by the Telephone Company, on the premises of a customer or authorized users, are the property of the Telephone Company, and are provided upon the condition that such facilities and lines, except as expressly provided for in this Tariff, must be installed, relocated and maintained by the Telephone Company. The customer or authorized users shall not unreasonably restrict the right of the Telephone Company, its employees and agents, to enter said premises at any reasonable hour to make collections from coin boxes, to install, inspect or repair any part of the Telephone Company's facilities and lines.

OUTGOING AND INCOMING SERVICE PRIVILEGES - The Tariffs and rate schedules of the Company govern and fix the outgoing service of a customer and in no manner guarantee to him the same incoming service. All incoming service of a customer depends upon and is limited by the right of a calling customer to such service. (M)

PRORATING OF BILLS - Bills for telephone service are normally rendered on a monthly basis. Bills rendered for establishment of services and final bills rendered for discontinuation of business services will be prorated on the basis of a thirty (30) day billing period. Final bills rendered after customer-requested discontinuance of residential service will not be pro-rated and service will remain available to the customer until the first day of the customer's next billing cycle. (N)

(M) Material moved from Eleventh Revised Sheet 4 of this section.

ISSUED:
July 2, 2020

EFFECTIVE
July 17, 2020

GENERAL EXCHANGE TARIFF

UNITED TELEPHONE COMPANY
OF THE WEST d/b/a CenturyLink
NEBRASKA

GRR
Twelfth Revised Sheet 4
Cancels Eleventh Revised Sheet 4

GENERAL RULES AND REGULATIONS APPLYING TO TELEPHONE SERVICE

(M)

(M)

PROTECTION OF CONSTRUCTION AGAINST OTHER USERS OF PREMISES - The customer shall protect the construction of the Telephone Company used to render the service to him against other users of his property when, in the judgment of the Telephone Company, such other uses would impair its service or constitute a hazard to its property or to the safety of its employees.

SCHOOL AND LIBRARY DISCOUNTS (E-Rate) - Pursuant to FCC Order 97-157, CC Docket 96-45, and adopted by the Nebraska Public Service Commission, Application No. C-1558, schools and libraries may be eligible for reduced rates funded by the Federal Universal Service Fund.

a. General

The Universal Service Support Mechanism was established to ensure affordable telecommunications service to all Americans including low-income consumers and eligible schools and libraries. Public and private schools (grades Kindergarten - Twelve) and public libraries and qualifying consortia may be eligible to apply for support discounts (Support) through the Schools and Libraries Universal Service Support Mechanism (E-Rate Program) in connection with the purchase of Company's services and equipment (Service).

In addition, these Customers may be eligible for state or local corollaries to the E-Rate Program. The Support may be provided by the E-rate Program in the form of a discount percentage of the billed charges for eligible Service. Schools, libraries, and consortia eligible for E-rate support pursuant to 47 Code of Federal Regulations part 54, subpart F shall comply with all E-rate Program rules and regulations in order to receive the Support.

b. Application for Support

1. E-Rate Program

The Customer will abide by all E-Rate Program rules for receipt of Support. The Customer is responsible for applying to the Schools and Libraries Division (SLD) of the Universal Service Administrative Company (or other authorized E-Rate Program administrator) for Support from the E-Rate program each year the Customer is eligible for the Support. The Customer will notify the Company in writing within 30 days of its receipt of a Funding Commitment Decision Letter from the SLD along with a copy of the notice and other relevant documentation as requested by the Company.

(M) Material moved to Second Revised Sheet 3A of this section.

ISSUED:
July 2, 2020

EFFECTIVE
July 17, 2020

NP 2019-004

Received by NPSC
07/02/2020

GENERAL EXCHANGE TARIFF

UNITED TELEPHONE COMPANY
OF THE WEST
NEBRASKA

GRR
First Revised Sheet 4.1
Cancels Original Sheet 4.1

GENERAL RULES AND REGULATIONS APPLYING TO TELEPHONE SERVICE

SCHOOL AND LIBRARY DISCOUNTS - (Cont'd)

b. Application for Support (Cont'd)

2. Other Funding Sources

The Customer is responsible for applying for Support from state and/or local administrators (Funding Sources). The Customer will notify **the Company** in writing within 30 days of its receipt of a Support commitment from such Funding Sources and will include a copy of its application, Funding Source Support documentation, and other relevant documentation as requested by **the Company**. (T)

c. Receipt of Support

1. E-Rate Program

The Customer will pay, in full, all invoices issued by **the Company** prior to **the Company's** receipt of notification from the Funding Source acknowledging the Customer's receipt of Service. Upon notification, **the Company** will apply discounts to the Customer's invoices or reimburse the Customer according to the Funding Commitment Decision Letter. The Customer is responsible to apply for SLD reimbursement (instead of receiving discounted **Company** bills) for all eligible customer premise equipment rentals or other financed arrangements. **The Company** reserves the right to require the Customer to seek SLD reimbursement (instead of receiving discounted **Company** bills) if the Customer has not received its Funding Commitment Decision Letter from the SLD by December 31 of the funding year. All discounts or reimbursements will be retroactive to the date authorized by the SLD funding year. **The Company** will either apply a credit to the Customer's account or provide the Customer with a check corresponding to the appropriate amount of Support based on Service received. (T)

2. Other Funding Sources

The Customer will pay, in full, all invoices issued by **the Company** prior to **the Company's** receipt of notification from the Funding Source acknowledging the Customer's receipt of Service. Upon notification, **the Company** will apply discounts or reimburse the Customer for Service delivered corresponding to the Funding Source acknowledgement. These discounts or reimbursements will be retroactive to the date authorized by the Funding Source funding year. **The Company** may reimburse the Customer with a credit to the Customer's account or with a check corresponding to the appropriate amount of Support based on Service received. (T)

ISSUED:
October 18, 2006

BY: Darlene Terry
Manager, Tariffs

EFFECTIVE:
October 28, 2006

GENERAL EXCHANGE TARIFF

UNITED TELEPHONE COMPANY
OF THE WEST
NEBRASKA

GRR
Second Revised Sheet 4.2
Cancels First Revised Sheet 4.2

GENERAL RULES AND REGULATIONS APPLYING TO TELEPHONE SERVICE

SCHOOL AND LIBRARY DISCOUNTS - (Cont'd)

- d. Failure to Obtain Support
1. The Customer will reimburse the Company if the FCC, SLD or Funding Sources fail to do so or if the FCC, SLD or Funding Sources reclaim any portion of Support sent to the Company on Customer's behalf. Customer will not be responsible for Support withdrawn due to the Company's material failure to provide Service.
 2. The Company is not responsible for the Customer's compliance with FCC, SLD or Funding Source rules and regulations, the Customer's applications for Support, or any decisions or actions by the FCC, SLD or Funding Sources with respect to the Customer.
 3. For Service agreements of more than one year, the Customer may not terminate the Agreement based solely on its failure to receive Support.

TRANSMISSION OF MESSAGES - The Telephone Company will not transmit messages, but offers the use of its facilities when available, and will not be liable for errors in transmission or for failure to establish connections. Employees of the Telephone Company are forbidden to accept either oral or written messages to be transmitted over the lines of the Company.

USE OF SERVICE FOR UNLAWFUL PURPOSES - The service is furnished subject to the condition it will not be used for an unlawful purpose. Service will not be furnished if any law enforcement agency, acting within its jurisdiction, advises that such service is being used or will be used in violation of law. If the Telephone Company receives other evidence giving reasonable cause to believe that such service is being or will be so used, it will either discontinue or deny the service or refer the matter to the appropriate law enforcement agency.

USE OF TELEPHONE SERVICE BY THE CUSTOMER - Telephone service is furnished for the exclusive use of the customer, employees, agents or representatives of the customer or members of the customer's domestic establishment except for Payphone Line **Service, or** as otherwise specified in this Tariff. The Telephone Company will not install or permit exchange service to remain at locations where the use of such service will be by the general public. Customers will discourage the use of their telephone service by others and repeated violations of its intended use may be sufficient cause to terminate the contract.

(C)

ISSUED:
June 16, 2009

BY: Darlene Terry
Manager, Tariffs

EFFECTIVE:
June 26, 2009

GENERAL EXCHANGE TARIFF

UNITED TELEPHONE COMPANY
OF THE WEST
NEBRASKA

Second Revised Sheet 5
Cancels First Revised Sheet 5

GENERAL RULES AND REGULATIONS APPLYING TO TELEPHONE SERVICE

WORK PERFORMED DURING OTHER THAN REGULAR WORKING HOURS - The rates and charges in this Tariff contemplate that work will be performed during regular working hours. At the customer's request, a charge may be applied in addition to which overtime or premium wage payments are in excess of the cost of handling the same work during regular hours, plus the estimated amount of any other unusual costs that are incurred in meeting the customer's request that the work be done in other than regular working hours.

ADJUSTMENTS FOR MUNICIPALITY PAYMENTS - When any city or village imposes upon the Telephone Company an occupation tax, license tax, permit fee or franchise fee, such tax or fee shall, insofar as practicable, be billed prorata to the exchange customers receiving service within the territorial limits of such municipal corporation.

SPECIAL ARRANGEMENTS - The rates and charges applying to telephone service and to any facilities associated therewith, contemplate standard arrangements. Special arrangements are furnished only at the customer's request. In the event that special arrangements are provided, the charges will be determined from the estimated cost of providing such arrangement.

Estimated cost consists of an estimate of the following items to the extent that they are applicable:

- a. Cost of maintenance.
- b. Cost of operation.
- c. Depreciation on the estimated cost installed of any facilities provided based on the anticipated useful service life of the facilities with an appropriate allowance for the estimated net salvage.
- d. Administration, taxes, and uncollectible revenue on the basis of reasonable average charges for these items.
- e. Any other specific items of expense associated with the particular situation.
- f. A reasonable amount, computed on the estimated cost installed of any facilities provided, for return and contingencies.

ISSUED:
December 1, 1987

BY: Warren D. Hannah
Director, Local Tariffs

EFFECTIVE:
January 1, 1988
Docket No. C-738

GENERAL EXCHANGE TARIFF

UNITED TELEPHONE COMPANY OF THE WEST
d/b/a CENTURYLINK
NEBRASKA

Fifth Revised Sheet 6
Cancels Fourth Revised Sheet 6

GENERAL RULES AND REGULATIONS APPLYING TO TELEPHONE SERVICE

SPECIAL ARRANGEMENTS (Cont'd)

Estimated cost installed as mentioned in c. and f. above, includes cost of materials specifically provided or used plus the estimated cost of installing, including engineering, labor, supervision, transportation, rights of way and any other items which are chargeable to the capital accounts.

APPLICATIONS FOR SERVICE - Applications for establishment of service must be made on the Telephone Company's standard form of application. These applications become contracts upon approval or upon the establishment of the service. Requests from a customer for additional services may be made orally or in writing and, upon approval or installation of the service, become a part of the original contract except that each item of additional service so installed is subject to the appropriate minimum contract term.

Any change in rates or regulations authorized by the legally constituted authorities will act as a modification of all contracts to that extent without further notice.

OBLIGATION TO FURNISH SERVICE - The Telephone Company's obligation to furnish telephone service is dependent upon its ability to procure and retain suitable facilities and rights for the construction and maintenance of the necessary circuits. Whenever suitable facilities are insufficient to furnish service to all who may apply, facilities will first be made available in accordance with regulations set forth in Section 3 of the Access Service Tariff concerning Telecommunications Service Priority (TSP).

RESALE OF SERVICE - Facilities on subscribers' premises furnished by the Telephone Company shall not be used for performing any part of the work of transmitting, delivering, or collecting any message where any toll or consideration has been or is to be paid any party other than the Telephone Company, except where otherwise provided by this tariff.

(M)
|
(M)

(M) Certain material previously appearing on this sheet now appears on Sheet 6A.

ISSUED:
July 21, 2017

BY: Darlene N. Terry
Manager, Tariffs

EFFECTIVE:
August 1, 2017

GENERAL EXCHANGE TARIFF

UNITED TELEPHONE COMPANY OF THE WEST
d/b/a CENTURYLINK
NEBRASKA

First Revised Sheet 6A
Cancels Original Sheet 6A

GENERAL RULES AND REGULATIONS APPLYING TO TELEPHONE SERVICE

CANCELLATION OF APPLICATION FOR SERVICE - The following conditions apply for all services. Additional provisions governing cancellation of applications for Private Line and Special Design Services are specified in Section 18.C.10.

(N)
|
(N)

When an application or request for service, for which the minimum contract period is longer than one month, or which requires a special assembly of equipment or special engineering, is canceled in whole or in part before service is established, the applicant or customer is required, on demand, to reimburse the Telephone Company for all expense incurred in connection with the application for service and the installation of the required equipment and facilities before notice of cancellation is received. Such charges are not to exceed the service connection, construction, installation and termination charges otherwise applicable if the service had been established.

(M)
|
(M)

Where a contract for service with a one month minimum contract period is canceled before establishment of service is completed, a charge equal to the costs incurred by the Telephone Company not to exceed the minimum service charge specified, is applied if all or a portion of the equipment or facilities has been installed.

CONNECTIONS WITH CERTAIN FACILITIES OF CUSTOMERS - Customer-provided customer premise inside wire and terminal equipment may be used and customer-provided communications systems may be connected with the facilities furnished by the Telephone Company for telecommunications services as provided in Section 23 of this tariff.

(M) Material previously appeared on Fourth Revised Sheet 6.

ISSUED:
July 21, 2017

BY: Darlene N. Terry
Manager, Tariffs

EFFECTIVE:
August 1, 2017

GENERAL EXCHANGE TARIFF

UNITED TELEPHONE COMPANY
OF THE WEST
NEBRASKA

Fifth Revised Sheet 7
Cancels Fourth Revised Sheet 7

GENERAL RULES AND REGULATIONS APPLYING TO TELEPHONE SERVICE

EXCHANGE TELEPHONE SERVICE - Exchange telephone service is the furnishing of facilities for telecommunications within an exchange in accordance with the regulations and system of charges specified in this General Exchange and the Local Exchange Tariffs.

DISCONNECT AND REMOVAL - Subscribers may not disconnect or remove or permit others to disconnect or remove facilities installed by the Telephone Company, except upon the written consent of the Company. (C)

USE OF LINES OF OTHER TELEPHONE COMPANIES - When suitable arrangements can be made, lines of other telephone companies may be used in conjunction with the Telephone Company's lines in establishing wire connections to points not reached by the Telephone Company's lines. In establishing connections with the lines of other companies, the Telephone Company will not be responsible or liable for any action of the connecting company. (D)

DIRECT CONNECTION - Customer provided customer premise inside wire and customer provided customer premise equipment or protective circuitry will be directly connected in accordance with Part 68 of the F.C.C. Rules and Regulations which requires the installation of a standard plug and jack arrangement or Network Interface Device by the Telephone Company for all one and two line customers that provide their inside wire. While standard jacks are required by Part 68 of the F.C.C. Rules and Regulations for customer premise equipment, non-standard jacks may be used as a means of connection for grandfathered equipment when standard jacks are not available.

TRANSMITTED RECORDED ANNOUNCEMENTS - Use of Telephone Company facilities or service in connection with automatic announcement service, automatic answering and recording service, recorder-coupler service or miscellaneous devices for recorded public announcements are subject to the following conditions.

- a. For purposes of identification, subscribers to telephone service who transmit recorded public announcements over facilities provided by the Company must include in the recorded message the name of the organization or individual responsible for the service and the address at which those responsible for the transmitted recorded announcement may be contacted.
- b. Subscribers transmitting factual public announcements such as Time, Stock Market quotations, Airline schedules and similar information are excluded from the preceding condition.

ISSUED:
December 1, 1987

BY: Warren D. Hannah
Director, Local Tariffs

EFFECTIVE:
January 1, 1988
Docket No. C-738

GENERAL EXCHANGE TARIFF

UNITED TELEPHONE COMPANY
OF THE WEST d/b/a CenturyLink
NEBRASKA

Eighth Revised Sheet 8
Cancels Seventh Revised Sheet 8

GENERAL RULES AND REGULATIONS APPLYING TO TELEPHONE SERVICE

TRANSMITTED RECORDED ANNOUNCEMENTS (Cont'd)

- c. Non-published telephone service will not be furnished for use with recorded public announcements.
- d. Failure to comply with the provisions of this Tariff shall be cause for termination of the service.

WAIVER OF INSTALLATION AND/OR SERVICE CONNECTION CHARGES - The Telephone Company may waive the service connection or installation charge for a limited period for new or existing services or products during special promotional periods to existing customer who wish to participate.

These special promotions will be offered on a non-discriminatory basis with each customer in the classification of service and area for which the promotion is offered having an equal opportunity to participation subject to the availability of services and facilities or products.

RESIDENCE SERVICE FOR COMPANY EMPLOYEES - The same rules and regulations are applicable to employees and retirees of the Company as are applicable to the general public. Certain telephone services will be furnished to Company employees and Company retirees at reduced rates as authorized by Company practices and procedures.

(M)
—
(M)

Received

NOV 18 2019

(M) Material previously found on this sheet was moved to Sheet 9.

NEPCC Comm. Dept.

ISSUED:
November 8, 2019
NE 19-10

BY: Darlene Terry
Manager, Tariffs

EFFECTIVE:
November 18, 2019

GENERAL EXCHANGE TARIFF

UNITED TELEPHONE COMPANY
OF THE WEST d/b/a CenturyLink
NEBRASKA

Second Revised Sheet 9
Cancels First Revised Sheet 9

GENERAL RULES AND REGULATIONS APPLYING TO TELEPHONE SERVICE

NATURAL DISASTER RELIEF FOR CUSTOMERS

In situations where customers' telecommunications services are interrupted by natural disasters, the Company may offer alternative telecommunications services to customers in the immediate affected area, and waive otherwise applicable charges for those services. The availability and details of the offers, including, but not limited to, the maximum duration of the offer or waiver of any applicable charges, will be determined by the Company in each instance of natural disaster.

SERVICE LIABILITIES

- 1. Customer will defend and indemnify the Company, its affiliates, agents and contractors from all third party claims, liabilities, fines, penalties, costs and expenses, including reasonable attorneys' fees, arising from or related to customer's, customer's end user's or customer's third-party provider(s) acts, omissions (including the failure to purchase or implement features that enable the receipt and transmission of direct-dial "911" calls or multi-line telephone system notifications), or failures of connectivity that impede, prevent or otherwise make inoperable the ability of the customer or its end users to directly dial "911" or to receive or transmit multi-line telephone system notifications, as required by law, in the United States. (T)
- 2. **Customer will defend and indemnify the Company, its affiliates, agents and contractors from all third party claims, liabilities, fines, penalties, costs and expenses, including reasonable attorneys' fees, arising from or related to any acts or omissions by the customer, customer's end users or customer's third-party provider(s) that cause, give rise to or bring about the non-compliance of the service with any applicable law, including the failure to purchase or implement features that enable compliance with laws.** (N)

(T)

(N)

(N)

(M)

(M) Material moved to Original Sheet 9.1 of this section.

(M)

ISSUED:
May 20, 2021

BY: Darlene Terry
Director, Tariffs

EFFECTIVE:
July 1, 2021

NE 2001-10

Received by NPSC
05/19/2021

GENERAL EXCHANGE TARIFF

UNITED TELEPHONE COMPANY
OF THE WEST d/b/a CenturyLink
NEBRASKA

Original Sheet 9.1

GENERAL RULES AND REGULATIONS APPLYING TO TELEPHONE SERVICE

RESPONSIBILITIES OF THE CUSTOMER

(M)

Multi-Line Telephone Systems

1. Pursuant to 47 CFR §9.16(b)(1) and (2), multi-line telephone systems connected to the Company's network which were manufactured, imported, sold, leased, or installed after February 16, 2020 must be configured to:

(T)

- allow an end user to directly initiate a "911" call from any station equipped with dialing facilities, without dialing any additional digit, code, prefix, or post-fix, including any trunk-access code such as the digit 9, regardless of whether the user is required to dial such a digit, code, prefix, or post-fix for other calls, and
- provide MLTS notification to a central location at the facility where the system is installed or to another person or organization regardless of location, if the system is able to be configured to provide the notification without an improvement to the hardware or software of the system.

MLTS notification must (1) be initiated contemporaneously with the 911 call, provided that it is technically feasible to do so; (2) not delay the call to 911; and (3) be sent to a location where someone is likely to see or hear it.

Customers who connect multi-line telephone systems to the Company's facilities must agree to defend and indemnify the Company for acts and omissions resulting in non-compliance, as described in 1. of the Service Liabilities section above.

(M) (T)

2. Pursuant to 47 C.F.R. § 9.16(b)(3), a person engaged in the business of installing MLTS may not install such a system in the United States unless it is configured such that it is capable of being programmed with and conveying the dispatchable location of the caller, as defined in 47 C.F.R. § 9.3, to the PSAP with 911 calls consistent with the requirements below. A person engaged in the business of managing or operating MLTS may not manage or operate such a system in the United States unless it is configured such that the dispatchable location of the caller, as defined in 47 C.F.R. §9.3, is conveyed to the PSAP with 911 calls consistent with the following requirements:

(N)

- On-premise fixed telephones associated with a MLTS must provide dispatchable location by January 6, 2021;
- No later than January 6, 2022, on-premise non-fixed telephones associated with a MLTS must provide dispatchable location where technically feasible, otherwise they shall provide dispatchable location based on end user manual update or on alternative location information as defined in 47 C.F.R. § 9.3;

(N)

ISSUED:
May 20, 2021

BY: Darlene Terry
Director, Tariffs

EFFECTIVE:
July 1, 2021

65.11.1.10

Received by NPSC
05/19/2021

GENERAL EXCHANGE TARIFF

UNITED TELEPHONE COMPANY
OF THE WEST d/b/a CenturyLink
NEBRASKA

Original Sheet 9.2

GENERAL RULES AND REGULATIONS APPLYING TO TELEPHONE SERVICE

RESPONSIBILITIES OF THE CUSTOMER

Multi-Line Telephone Systems

B. Pursuant to 47 C.F.R. § 9.16(b)(3)...the following requirements: (Cont'd)

- No later than January 6, 2022, off-premise non-fixed telephones associated with a MLTS must provide dispatchable location where technically feasible, otherwise they shall provide dispatchable location based on end user manual update, or enhanced location information which may be coordinate based and consisting of the best available location that can be obtained from any available technology or combination of technologies at reasonable cost.
- Additionally, providers of fixed telephony services shall provide automated dispatchable location with 911 calls beginning January 6, 2021 pursuant to 47 C.F.R. § 9.8. Providers of interconnected VoIP service must comply with the location requirements under 47 C.F.R. § 9.11(b)(iv) for non-fixed services as of January 6, 2022. Customers to DID Service capable of accessing 911 emergency services shall be responsible for providing automated dispatchable location information as defined in 47 C.F.R. § 9.3 and for maintaining the accuracy of that information for fixed services as of January 6, 2021 and for non-fixed services where technically feasible as of January 6, 2022.
- Customers, particularly private switch owners, private branch exchange owners, and customers of DID service, may need to purchase additional features or services to comply with the dispatchable location provisions of RAY BAUM's Act. Dispatchable location capability may require Customers to purchase private switch automatic location identification (PS/ALI) service from the Company or from a third-party provider.

Customers who connect multi-line telephone systems to the Company's facilities must agree to defend and indemnify the Company for acts and omissions resulting in non-compliance, as described in 2. of the Service Liabilities section above.

ISSUED:
May 20, 2021

BY: Darlene Terry
Director, Tariffs

EFFECTIVE:
July 1, 2021

4-15-21-19

Received by NPSC
05/19/2021

GENERAL EXCHANGE TARIFF

UNITED TELEPHONE COMPANY
OF THE WEST d/b/a CenturyLink
NEBRASKA

Original Sheet 10

GENERAL RULES AND REGULATIONS APPLYING TO TELEPHONE SERVICE

OBSOLETE/GRANDFATHERED SERVICES

As of March 1, 2022, changes, additions, or transfer of service will not be permitted on accounts associated with a grandfathered bundle or package or other grandfathered feature or service. This change does not impact services or features currently provided on grandfathered accounts. A grandfathered service is one that is no longer sold, and availability is limited to lines currently in service at existing locations. Changes, additions, or transfer of service will be allowed when customers migrate from a grandfathered service to a currently available service. Customers may remove any service or feature from their accounts at any time; however, grandfathered services removed may not be subsequently reinstated.

ISSUED:
February 17, 2022

BY: Chantel Miller
Director, Government Operations

EFFECTIVE:
March 1, 2022

NE2022-07

Received by NPSC
02/17/2022

GENERAL EXCHANGE TARIFF

UNITED TELEPHONE COMPANY
OF THE WEST
NEBRASKA

Third Revised Sheet 1
Cancels Second Revised Sheet 1

GENERAL EXPLANATION OF TERMS

ACCESSORIES

Denotes devices which are mechanically attached to, or used with, the communicating devices furnished by the Company and which are independent of, and not connected to the conductors in the communications path of the telecommunications system.

AIR LINE MEASUREMENT

See Mileage Charges.

ALTERNATING CURRENT SUPPLY

Electrical energy which is used for power purposes, protection of equipment in humid areas, and for the operation of bells and signal devices.

APPOINTMENT CALL

See Long Distance Message Telecommunications Service.

BATTERY POWER

See Private Branch Exchange Service.

BUILDING (SAME)

The term "same building" is to be interpreted as a structure under one roof, or two or more structures under separate roofs but connected by enclosed passage-ways which do not cross public thoroughfares in which wires or cables of the Company can be safely run and provided the plant facility requirements are not appreciably greater than would be required normally if structures were under one roof. In those cases where there are several structures under separate roofs but connected by enclosed passageways and the plant facility requirements for furnishing telephone service are appreciably greater than would be required normally if all the structures were under one roof, then term "same building" applies individually to each of the separate structures. Pipes and conduit are not considered enclosed passageways.

CANCELLATION CHARGES

A charge applicable under certain conditions when application for service and/or facilities is canceled in whole or in part prior to the completion of the work involved.

CAPTION LISTING

See Directory Listing.

CENTRAL OFFICE

A central office is a local operating unit by means of which intercommunication is provided for subscribers within a specified area under contract for exchange service. An essential characteristic of a central office is switching equipment to which telephone stations are connected by means of circuits defined as "Central Office Lines".

(D)
—
(D)

ISSUED:
June 16, 2009

BY: Darlene Terry
Manager, Tariffs

EFFECTIVE:
June 26, 2009

GENERAL EXCHANGE TARIFF

UNITED TELEPHONE COMPANY
OF THE WEST
NEBRASKA

Third Revised Sheet 2
Canceling Second Revised Sheet 2

GENERAL EXPLANATION OF TERMS

CENTRAL OFFICE DESIGNATION
See Telephone Number.

CENTRAL OFFICE DISTRICT OR AREA
The specific section or area served by a single central office and serving all subscribers lines which have a common central office designation.

(D)

CENTREX SERVICES
A service arrangement of dial switching equipment and facilities which permits completion of inward and outward local and long distance calls from stations associated with the System without intermediate handling by the attendant.

(D)

CENTREX TRUNK LINES

- a. Interior Centrex Trunk Line: Interior station line terminated on another system allowing access only to other Centrex stations through the Centrex switching equipment.

ISSUED:
December 1, 1987

BY: Warren D. Hannah
Director, Local Tariffs

EFFECTIVE:
January 1, 1988
Docket No. C-738

GENERAL EXCHANGE TARIFF

UNITED TELEPHONE COMPANY
OF THE WEST d/b/a CenturyLink
NEBRASKA

Third Revised Sheet 2A
Canceling Second Revised Sheet 2A

GENERAL EXPLANATION OF TERMS

CENTREX TRUNK LINES (Cont'd)

- b. Main Centrex Trunk Line: Main station line terminated on another system allowing access to the Centrex central office trunks and other Centrex stations through the Centrex switching equipment.

CHANNEL

An electrical path suitable for the transmission of communications.

CLASS OF SERVICE

A description of service furnished a subscriber in terms such as:

- a. For Exchange Service:

Grade of Line: Individual line, trunk, etc.
(See also "Primary Class of Service")

Type of Rate: Flat rate or measured rate.

Character of Use: Business or Residence

Dialing Method: U-Touch or Rotary

- b. For Long Distance Message Telecommunications Service: Type of Call: Station-to-station or person-to-person

(M)
(M)

(M) Material moved to Fifth Revised Sheet 3 of this section.

ISSUED:
November 30, 2018

BY: Darlene Terry
Manager, Tariffs

EFFECTIVE:
December 10, 2018

GENERAL EXCHANGE TARIFF

UNITED TELEPHONE COMPANY
OF THE WEST d/b/a CenturyLink
NEBRASKA

Fifth Revised Sheet 3
Canceling Fourth Revised Sheet 3

GENERAL EXPLANATION OF TERMS

CLASS OF SERVICE (Cont'd)

(M)
(M)

(D)
(D)

COLLECT CALL

The procedure by which certain messages, upon request, may be reserved (charged to the called line) upon acceptance of the call at the called line.

COMMON EQUIPMENT

See Private Branch Exchange Service.

COMMUNICATING DEVICE

A device consisting of a transmitter, receiver, network control signaling unit, and associated apparatus and so connected as to permit the sending and receiving of telecommunication messages through the exchange and long distance network.

COMMUNICATIONS SYSTEMS

Channels and other facilities which are capable, when not connected to telecommunication service, or 2-way communication between customer-provided terminal equipment or Company stations.

COMPANY

Whenever used in this Tariff, "Company" refers to the United Telephone Company of the West unless the context clearly indicates otherwise.

(M) Material moved from Second Revised Sheet 2A of this section.

ISSUED:
November 30, 2018

BY: Darlene Terry
Manager, Tariffs

EFFECTIVE:
December 10, 2018

NE 18-04

GENERAL EXCHANGE TARIFF

UNITED TELEPHONE COMPANY
OF THE WEST
NEBRASKA

First Revised Sheet 3A
Canceling Original Sheet 3A

GENERAL EXPLANATION OF TERMS

(T)

COMPANY STATION
See Station.

CONNECTING ARRANGEMENT

The term "connecting arrangement" denotes the protective equipment to accomplish the direct electrical connection of customer-provided facilities with the facilities of the Company, when such customer-provided equipment does not conform to Part 68 of the F.C.C. Rules and Regulations for direct connection of customer-provided terminal equipment.

ISSUED:
February 3, 1987

BY: Warren D. Hannah
Director, Local Tariffs

EFFECTIVE:
February 3, 1987
Docket No. C-658

GENERAL EXCHANGE TARIFF

UNITED TELEPHONE COMPANY
OF THE WEST
NEBRASKA

Second Revised Sheet 4
Canceling First Revised Sheet 4

GENERAL EXPLANATION OF TERMS

CONNECTING COMPANY

A corporation, association, firm or individual owning and operating a toll line or one or more central offices and with whom traffic is interchanged.

CONNECTING STATION

An exchange or toll subscriber of a connecting company.

CONSTRUCTION CHARGE

A separate initial charge made for construction of pole lines, circuits, facilities, etc., in excess of that contemplated under the rates quoted in the exchange tariffs.

CONTRACT PERIOD

The length of time for which a subscriber is responsible for the charges associated with the services, facilities, and equipments under contract.

COST

Wherever the word "cost" is used in this Tariff, it is intended to cover the cost of labor, materials and incidentals, plus a charge for supervision.

CUSTOMER PREMISE INSIDE WIRE

The non-system premise wiring, including connectors and blocks within a customer's premise, that extends between the demarcation point of the exchange access line and those standard jack locations within the customer's premise to which terminal equipment can be connected for access to the network.

(N)
|
(N)

CUSTOMER-PROVIDED TERMINAL EQUIPMENT

Devices or apparatus and their associated wiring, provided by a customer, which are connected to the communications path of the Company's exchange network either electrically, acoustically or inductively.

DATA ACCESS ARRANGEMENT

The term "data access arrangement" denotes a protective connecting arrangement for use with the network control signaling unit, or in lieu of the connecting arrangement, an arrangement for use with the network control signaling to identify a central office line and protective facilities and procedures to determine compliance with criteria set forth in Section 23 of this Tariff.

ISSUED:
February 3, 1987

BY: Warren D. Hannah
Director, Local Tariffs

EFFECTIVE:
February 3, 1987
Docket No. C-658

GENERAL EXCHANGE TARIFF

UNITED TELEPHONE COMPANY OF THE WEST
d/b/a CENTURYLINK
NEBRASKA

First Revised Sheet 4A
Cancels Original Sheet 4A

GENERAL EXPLANATION OF TERMS

DATA SET

A device designed to accept from and/or impart to customer-provided data transmitting and/or receiving terminal equipment, material in the form produced and/or accepted by the customer-provided terminal equipment into a form acceptable for transmission over company facilities.

DEMARCATIION POINT

The point of interconnection between the Telephone Company communications facilities and the equipment, protective apparatus or wiring at a customer's premises. The interface or demarcation point shall be located at the customer's side of the Telephone Company's protector, or the equivalent thereof in cases where a protector is not employed, as provided under the Company's standard operating practices; it shall be as close as feasible to where the access line enters the customer's premise. If a Network Interface Device is present, the Telephone Company's facilities end at the customer's side of the device.

DESIGN SERVICE

A service that is not immediately available for provisioning and requires treatment, equipment or engineering design (e.g. ISDN-PRI, DS1, Private Line, Foreign Exchange Service).

(N)
|
(N)

DIRECT CONNECTION

Connection of terminal equipment to the company's exchange facilities by means other than acoustic and/or inductive coupling.

DIRECT CURRENT SUPPLY

Electrical energy for talking and signaling purposes, other than ringing.

DIRECT ELECTRICAL CONNECTION

A physical connection of the electrical conductors in the communications path.

DIRECTORY ASSISTANCE SERVICE

A service provided to assist customers in obtaining telephone numbers which are or are not listed in the directory.

ISSUED:
July 21, 2017

BY: Darlene N. Terry
Manager, Tariffs

EFFECTIVE:
August 1, 2017

GENERAL EXCHANGE TARIFF

UNITED TELEPHONE COMPANY OF THE WEST
d/b/a CENTURYLINK
NEBRASKA

Sixth Revised Sheet 5
Cancels Fifth Revised Sheet 5

GENERAL EXPLANATION OF TERMS

DIRECTORY LISTING

The publication in the Company's directory and/or directory assistance records, of information relative to a subscriber's telephone number, by which telephone users are enabled to ascertain the call number of a desired station.

- (a) Caption Listing: The listing of a subscriber's name without address or telephone number followed by a series of indented listings covering branches or different departments of the business.
- (b) Foreign Exchange Listing: The listing of a subscriber in the alphabetical list of an exchange other than that for the exchange from which the subscriber is served.
- (c) Free Listing: A directory listing for which no specific charge is made.
- (d) Indented Listing: A directory listing indented under another listing.
- (e) Reference Listing: The listing of a generally accepted name of a firm or corporation followed by a reference to another listing.

DISCONNECTION OF SERVICE

An arrangement made at the request of the subscriber, or initiated by the Company for violation of tariff regulations by the subscriber, for a permanent interruption of telephone service.

DISTRICT SERVICE AREA

See Local Service Area.

DOMITORY STATION

See Centrex Stations.

DROP WIRE

That portion of a circuit between the pole line or cable distributing box and the protector or equivalent.

EMBARQ LOCAL OPERATING COMPANY (a.k.a. Embarq LOC)

The term used to describe Embarq Corporation's Incumbent Local Exchange Carrier (ILEC).

(M)
|
(M)

(M) Certain material previously appearing on this sheet now appears on Sheet 6.

ISSUED:
July 21, 2017

BY: Darlene N. Terry
Manager, Tariffs

EFFECTIVE:
August 1, 2017

GENERAL EXCHANGE TARIFF

UNITED TELEPHONE COMPANY
OF THE WEST
NEBRASKA

Fifth Revised Sheet 6
Canceling Fourth Revised Sheet 6

GENERAL EXPLANATION OF TERMS

EXCHANGE

A toll rate center served by one or more central offices, together with the subscribers' stations and lines connected thereto, forming a local system for furnishing telephonic intercommunication without toll charges between subscribers within a specified area, usually a single city or town, and environs. (M)

When an exchange includes only one central office, it is termed a single office exchange, but when it includes more than one central office, the exchange is termed a multi-office exchange. (M)

EXCHANGE SERVICE

The general telephone service rendered in accordance with individual Local Exchange Tariff and General Exchange Tariff provisions. Exchange service is a general term describing as a whole, the facilities for local intercommunications, together with the right to send and receive a specified or an unlimited number of local messages at charges in accordance with the provisions of the Local or General Exchange Tariffs.

- (a) Extension Service: A classification of exchange service, furnished to a subscriber that is connected on the same central office access line as a main station.
- (b) Flat Rate Service: A classification of exchange service furnished to a subscriber under Tariff provisions, for which a stipulated charge is made, regardless of the amount of use.
- (c) Foreign Central Office Service: A classification of exchange service furnished to a subscriber in a multi-office exchange from a central office other than the one from which service would normally be furnished.
- (d) Foreign Exchange Service: A classification of exchange service furnished to a subscriber from an exchange other than the one from which he would normally be served.
- (e) Individual Line Service: A classification of exchange service which provides that only one subscriber shall be served by the circuit connecting such subscriber with the central office or other switching unit.
- (f) Message Rate Service (measured rate): A classification of non-coin box exchange service which is charged for on the basis of amount of use.

(M) Material previously appeared on Fifth Revised Sheet 5.

ISSUED:
July 21, 2017

BY: Darlene N. Terry
Manager, Tariffs

EFFECTIVE:
August 1, 2017

GENERAL EXCHANGE TARIFF

UNITED TELEPHONE COMPANY
OF THE WEST
NEBRASKA

Tenth Revised Sheet 7
Cancels Ninth Revised Sheet 7

GENERAL EXPLANATION OF TERMS

EXCHANGE SERVICE (Cont'd)

- (g) Touch-Tone Calling Service: A classification of exchange service furnished from certain specified central offices whereby calls are originated through the use of pushbuttons in lieu of a rotary dial.

(D)

(D)

(T)

EXCHANGE SERVICE AREA

The area within which the Company furnishes complete local telephone service at the exchange rates applicable within that area.

EXCHANGE STATION

See Station.

EXTENDED AREA SERVICE

A type of telephone service furnished under Tariff provisions whereby subscribers of a given exchange may complete calls to and/or may receive calls from one or more exchanges without the application of long distance message telecommunications charges.

EXTENSION LINE MILEAGE

See Mileage Charges.

EXTENSION RINGER

An additional ringer on the same circuit and operated in connection with the ringer at the station. Extension ringers are of two types:

GENERAL EXCHANGE TARIFF

UNITED TELEPHONE COMPANY
OF THE WEST
NEBRASKA

First Revised Sheet 7A
Cancels Original Sheet 7A

GENERAL EXPLANATION OF TERMS

EXTENSION RINGER (Cont'd)

- (a) Extension Bell (Ordinary Type): An additional bell of the type used on standard telephone instruments, connected with the same circuit as the first bell, but mounted separately and generally installed at some distance from the station.
- (b) Extension Gong (Loud Ringing Type): A loud sounding bell connected in the same manner as the ordinary type of extension bell for use in noisy or other locations where the common type of bell would not be heard.

FLAT RATE SERVICE
See Exchange Service.

FOREIGN CENTRAL OFFICE MILEAGE
See **Mileage Charges**.

(D)

FOREIGN CENTRAL OFFICE SERVICE
See Exchange Service.

FOREIGN EXCHANGE LISTING
See Directory Listing.

FOREIGN EXCHANGE MILEAGE
See **Mileage Charges**.

(D)

FOREIGN EXCHANGE SERVICE
See Exchange Service.

FREE LISTING
See Directory Listing.

GENERATOR

A mechanical device for producing electrical current for ringing. Generators designed to be hand operated are termed Hand Generators, and those which are not to be hand operated are termed Power Generators.

GENERAL EXCHANGE TARIFF

UNITED TELEPHONE COMPANY
OF THE WEST d/b/a CenturyLink
NEBRASKA

Fifth Revised Sheet 8
Canceling Fourth Revised Sheet 8

GENERAL EXPLANATION OF TERMS

HARM

Electrical hazards to company personnel, damage to company equipment, malfunctions of company billing equipment, and degradation of service to persons other than the user of the subject terminal equipment, as well as the calling or called party.

HEADSETS

A hands-free, multi-wire device containing acoustic-to-electric (transmitter) and electric-to-acoustic (receiver) transducers, normally worn on the head of the user for close talking, which provides 2-way voice grade transmission.

HOUSEHOLD (SAME)

Those who dwell as a family under one roof, including relatives and other persons residing with the family and participating in the common use of such facilities as dining room, kitchen, living room, etc. Premises occupied by any group of persons functioning in the same manner as a family are also considered as the same household.

INDENTED LISTINGS

See Directory Listing.

INDIVIDUAL LINE (A.K.A. ONE-PARTY LINE)

An exchange access line designed for the connection of one main station.

(N)
(N)

INDIVIDUAL LINE SERVICE

See Exchange Service.

INITIAL CHARGE

See Installation Charge

INITIAL SERVICE PERIOD

The minimum period of time for which service, facilities and equipment are provided.

INSTALLATION CHARGE

A non-recurring charge applying to the provision of certain items of equipment or facilities as distinguished from the service connection charge applicable for establishment of basis telephone service. The installation charge is normally associated with optional service features and may sometimes be called an "initial" charge.

INTEGRATED SERVICES DIGITAL NETWORK - BASE RATE INTERFACE (ISDN-BRI)

ISDN-BRI is a local exchange telecommunications service that provides integrated voice and data communications capability. ISDN-BRI supports the simultaneous transmission of circuit switched voice and circuit switched data over a single exchange access line. ISDN-BRI Service provides a customer two B-channels with transmission speeds up to 64 Kbps each and one 16 Kbps D-channel.

INTER-COMMUNICATING SYSTEM

See Communications Systems, and Key Telephone Systems.

ISSUED:
December 8, 2017

BY: Darlene Terry
Manager, Tariffs

EFFECTIVE:
December 19, 2017

GENERAL EXCHANGE TARIFF

UNITED TELEPHONE COMPANY
OF THE WEST
NEBRASKA

Original Sheet 8A

GENERAL EXPLANATION OF TERMS

INTERCEPT SERVICE

A service arrangement whereby a person calling a disconnected or discontinued telephone number is informed that the called telephone number has been discontinued, or disconnected, or changed to another number, or that calls are received by another telephone.

(L)

(L)

INTERFACE

See Demarcation Point

(C)

(D)

ISSUED:
February 3, 1987

BY: Warren D. Hannah
Director, Local Tariffs

EFFECTIVE:
February 3, 1987
Docket No. C-658

GENERAL EXCHANGE TARIFF

UNITED TELEPHONE COMPANY
OF THE WEST d/b/a CenturyLink
NEBRASKA

Fifth Revised Sheet 9
Cancels Fourth Revised Sheet 9

GENERAL EXPLANATION OF TERMS

INTERIOR CENTREX TRUNK LINE

See Centrex Trunk Lines.

INTERIOR STATION

See Private Branch (PBX) Service.

KEY TELEPHONE SYSTEMS (MULTI-LINE TELEPHONE SYSTEMS)

An arrangement of equipment in combination with telephone sets and associated keys, to connect the associated telephone to any one of a limited number of exchange, PBX, inter-communicating or private lines. Line indicating, signaling, holding features, etc., are, or may be, incorporated.

LIFELINE

A program sponsored by the Federal Communications Commission which provides **discounted basic local residential or broadband** service to qualifying low-income subscribers. **The Nebraska Telephone Assistance Program does not support broadband service.**

(C)
|
(C)

LISTING

See Directory Listing.

LOCAL CALLING AREA

See Local Service Area.

LOCAL MESSAGE

See Message.

LOCAL SERVICE

The term used to designate the privilege allowed a subscriber, of sending messages from his telephone station to another telephone station within a specified area without the payment of a toll charge.

LOCAL SERVICE AREA

The area within which telephone service is furnished subscribers under a specific schedule of exchange rates (flat or measured) and without toll charges. A local service area may include one or more exchange areas under extended area service arrangements.

LONG DISTANCE MESSAGE TELECOMMUNICATIONS SERVICE

The furnishing of facilities for subscribers' communications on an individual message basis between rate centers, or in connection with toll stations within the same rate center.

GENERAL EXCHANGE TARIFF

UNITED TELEPHONE COMPANY
OF THE WEST
NEBRASKA

Second Revised Sheet 10
Cancels First Revised Sheet 10

GENERAL EXPLANATION OF TERMS

LONG DISTANCE MESSAGE TELECOMMUNICATIONS SERVICE (Cont'd)

(T)

- (a) **Station-to-Station Call**
A service whereby the person originating the call either dials the telephone number desired, or gives to the long distance operator the telephone number of the desired station, Miscellaneous Common Carrier connecting circuit, Centrex, PBX, or PBX station which is reached directly rather than through a PBX attendant, or gives only the name and address under which such number is listed, and does not specify a particular person to be reached, nor a particular mobile station to be reached through a Miscellaneous Common Carrier attendant nor a particular station, department or office to be reached through a PBX or Centrex attendant.
- (b) **Person-to-Person Call**
A service whereby the person originating the call specified to the long distance operator a particular person to be reached, a particular mobile station to be reached through a Miscellaneous Common Carrier attendant, or a particular station, department, or office to be reached through a PBX or Centrex attendant.
- (c) **Appointment Call**
An arrangement made in advance with a particular party for the establishment of a person-to-person long distance **message** telephone connection at a specified time.
- (d) **Messenger Service**
An arrangement whereby the Company, when possible and at the request of the calling party, shall arrange to notify the called party of a long distance call. The Company shall be reimbursed by the calling party for the amount expended for such messenger service, such charges being subject to prior authorization by the calling party to the extent that they can be determined in advance. Such charges for messenger service are in addition to the tariff charges for the messenger.

(T)

MAIN CENTREX STATION
See Centrex Stations.

MAIN CENTREX TRUNK LINE
See Centrex Trunk Lines.

MAIN STATION
See Station.

GENERAL EXCHANGE TARIFF

UNITED TELEPHONE COMPANY
OF THE WEST
NEBRASKA

Third Revised Sheet 10A
Cancels Second Revised Sheet 10A

GENERAL EXPLANATION OF TERMS

MAINTENANCE OF SERVICE CHARGE

The non-recurring charge applicable in connection with a service difficulty when it is determined that the difficulty was caused by or resulted from the use of customer-provided customer premise inside wire, terminal equipment, protective circuitry, or communications system connected to Company facilities.

MANUFACTURER DISCONTINUED

The term "Manufacturer Discontinued" is used to denote items of equipment which are no longer purchased.

MESSAGE

A communication between two communicating devices. Messages may be classified as follows:

- (a) Local Message: A communication between communicating devices within the same local service area.
- (b) Toll (Long Distance) Message: A communication between communicating devices in different exchange areas for which a toll charge is made.

MESSAGE RATE SERVICE (Measured Rate)

See Exchange Service.

MESSENGER SERVICE

See Long Distance Message Telecommunications Service.

MILEAGE CHARGES

A charge applying for the use of part or all of a line furnished by the Company.

(D)

- (a) Air Line Measurement: The shortest distance between two points.
- (b) Route Measurement: The actual length of a circuit between two points.
- (c) Extension Line Mileage: The measurement applying to that portion of an extension line to which mileage charges are applicable.
- (d) Foreign Central Office Mileage: The measurement applying to that portion of a circuit connecting a subscriber's main station or private branch exchange with a foreign central office.

ISSUED:
July 17, 2002

BY: Warren D. Hannah
Director, Tariffs

EFFECTIVE:
August 1, 2002

GENERAL EXCHANGE TARIFF

UNITED TELEPHONE COMPANY
OF THE WEST
NEBRASKA

Fourth Revised Sheet 11
Cancels Third Revised Sheet 11

GENERAL EXPLANATION OF TERMS

MILEAGE CHARGES (Cont'd)

- (e) Foreign Exchange Mileage: The measurement applying to that portion of a circuit connecting a subscriber's main station or private branch exchange with a central office of another exchange other than that from which the subscriber would normally be served.
- (f) Tie Line Measurement: The measurement upon which the rates for the tie line is based, in accordance with Tariff provisions.

MISCELLANEOUS COMMON CARRIERS

Miscellaneous Common Carriers, as defined in Part 21 of the Federal Communications Commission Rules, are communications common carriers which are not engaged in the business or providing either a public land-line message telephone service or public message telegraph service.

MISCELLANEOUS EQUIPMENT

Equipment furnished with the various classes of exchange service at additional charges.

MULTI-LINE TELEPHONE SYSTEMS

See Key Telephone Systems.

N11 SERVICES

Abbreviated three (3)-digit dialing codes which allow the caller to connect to a location in the local telephone network that otherwise would be accessible only through a seven (7)-or ten (10)-digit telephone number. The local telephone network must be preprogrammed to translate the three-digit code into the appropriate seven- or ten-digit telephone number and route the call accordingly. Among abbreviated dialing arrangements, "N11" codes are three-digit codes of which the first digit can be any digit other than 0 or 1, and the last two digits are both 1. 0 and 1 are unavailable because those digits are used for switching and routing. The following N11 codes have been designated by the FCC or by the telephone industry for the purpose listed below:

<u>N11 Code</u>	<u>Purpose</u>
211	<i>Allows access to community information and referral services. Designated by the FCC.</i>
311	<i>Allows access to non-emergency police and government services. Designated by the FCC.</i>
411	<i>Traditionally allows access to local directory assistance services of local telephone companies. Not designated by the FCC.</i>
511	<i>Allows access to traveler information services. Designated by the FCC.</i>
611/811	<i>Traditionally allows access to local telephone company repair and business offices. Not designated by the FCC.</i>
711	<i>Allows access to Telecommunications Relay Services (TRS) for individuals with hearing or speech disabilities. Designated by the FCC.</i>
911	<i>Federally mandated as the National Emergency Number and allows access to emergency services. Designated by the FCC and ordered by the United States Congress.</i>
011/111	<i>Not available. "0" and "1" are used for switching and routing purposes.</i>

(N)

(N)

(L)

(L)

(L) Material originally found on this sheet now appears on Original Sheet 11.1.

ISSUED:
December 11, 2002

BY: Warren D. Hannah
Director, Tariffs

EFFECTIVE:
December 23, 2002

GENERAL EXCHANGE TARIFF

UNITED TELEPHONE COMPANY
OF THE WEST
NEBRASKA

Original Sheet 11.1

GENERAL EXPLANATION OF TERMS

NETWORK CONTROL SIGNALING

The transmission of signals used in the Company's exchange facilities which perform functions such as supervision (control, status, and charging signals), address signaling (dialing), calling and called number identification, audible tone signals (call progress signals indicating re-order or busy conditions, altering, coin denominations, coin collect and coin return tones) to control the operation of switching machines in the telecommunications system.

(L)

(L)

(L) Material on this sheet was formerly found on Third Revised, Sheet 11.

ISSUED:
December 11, 2002

BY: Warren D. Hannah
Director, Tariffs

EFFECTIVE:
December 23, 2002

GENERAL EXCHANGE TARIFF

UNITED TELEPHONE COMPANY
OF THE WEST
NEBRASKA

Third Revised Sheet 12
Canceling Second Revised Sheet 12

GENERAL EXPLANATION OF TERMS

NETWORK CONTROL SIGNALING UNIT

The term "Network Control Signaling Unit" denotes the terminal equipment furnished for the provision of network control signaling.

NETWORK INTERFACE DEVICE (NID)

A device which readily permits the disconnection of customer-provided customer premise inside wiring from the Telephone Company network through an industry registered jack of a type provided for in FCC Rules and Regulations Part 68, for testing purposes, and is provided as part of the exchange access line.

NETWORK TERMINATING WIRE

Wire associated with a network service, which is installed upon customer request between the predetermined demarcation point and the customer's chosen demarcation point and which is used to connect the access line to the network interface.

NON-LISTED TELEPHONE NUMBER

A telephone number associated with an exchange station which at the request of the subscriber is not listed in the telephone directory but is made available by the Company to the general public upon request.

NON-PUBLISHED TELEPHONE NUMBER

A telephone number associated with an exchange subscriber which at the request of the subscriber is not listed in the telephone directory and is not made available to the general public by the Company. Company employees will not complete nor place calls to non-published telephone numbers unless the number is furnished by the calling party.

NON-POWERED CONFERENCING EQUIPMENT

Denotes a portable plug-ended device, without active elements, consisting of a multiwinding transformer and manual line switches designed to bridge two or more, but not to exceed five, of the lines appearing on six-button and ten-button key telephone station equipped with both hold and illumination features.

NON-SYSTEM PREMISES WIRING

Wiring which is used with one and two-line business and residence services, located at the customer's premises.

- (a) Fully protected non-system premises wiring: Non-system premises wiring which is electrically behind registered (or grandfathered) equipment or protective circuitry which assures that electrical contact between the wiring and commercial power wiring or earth ground will not result in hazardous voltages at the telephone network interface.

(T)

ISSUED:
June 16, 2009

BY: Darlene Terry
Manager, Tariffs

EFFECTIVE:
June 26, 2009

GENERAL EXCHANGE TARIFF

UNITED TELEPHONE COMPANY
OF THE WEST d/b/a CenturyLink
NEBRASKA

Fourth Revised Sheet 13
Canceling Third Revised Sheet 13

GENERAL EXPLANATION OF TERMS

NON-SYSTEM PREMISES WIRING (Cont'd)

- (b) Unprotected non-system premises wiring: All other non-system premises wiring.

ONE-PARTY LINE (1-PTY)
See "Individual Line".

(N)
(N)

PAYPHONE LINE SERVICE

Payphone line service is a class of service furnished to individuals, firms or corporations which permits connection of a customer-provided instrument that is activated by the deposit of coins, cards, tokens or the entry of a customer account number, to the lines of the Company.

PERSON-TO-PERSON CALL

See Long Distance Message Telecommunications Service.

PREMISE (SAME)

The term "same premise" (except in connection with RELOCATES) shall be interpreted to mean:

- (a) The building or buildings together with surrounding land occupied or used in the conduct of one establishment or business, or as a residence, and not intersected by a public thoroughfare or by land occupied by others; or
- (b) The portions of a building occupied by a subscriber used in the conduct of one business or as a residence and not intersected by a public corridor or by a space occupied by others; or
- (c) The building or portion of a building occupied by the subscriber in the conduct of his business and as a residence provided both have the same street address; or
- (d) The continuous property operated as a single farm whether or not intersected by a public road.

In connection with RELOCATES, the term "same premises" is to be interpreted to mean the building or portion of a building occupied as a unit by the subscriber in the conduct of his business or residence, or a combination thereof, and not intersected by a public thoroughfare, a public corridor or space occupied by others.

ISSUED:
December 8, 2017

BY: Darlene Terry
Manager, Tariffs

EFFECTIVE:
December 19, 2017

GENERAL EXCHANGE TARIFF

UNITED TELEPHONE COMPANY
OF THE WEST
NEBRASKA

Second Revised Sheet 13A
Cancels First Revised Sheet 13A

GENERAL EXPLANATION OF TERMS

PRIMARY CLASS OF SERVICE

Any classes of exchange service which the Company undertakes to furnish at a rate common to all applicants for the same class located in the same rate area. Primary classes of service may be furnished in other areas at applicable rates plus **extra mileage charges**.

(D)

PRIVATE BRANCH EXCHANGE SYSTEM

- (a) An arrangement of equipment consisting of a switchboard with operator telephone, trunks, to a central office and station connected with the switchboard, providing for telephone intercommunication between these stations, and also communication with the general exchange system.
- (b) A Private Branch Exchange is sometimes called a "P.B.X." or "P.A.B.X."
- (c) Manual cordless switchboard: an arrangement of keys to allow interconnection of stations and stations with trunks.
- (d) Manual non-multiple cord switchboard: an arrangement of jacks on which all station lines and trunks terminate with one appearance only. Interconnection of stations and stations with trunks is established by means of cord circuits equipped with cords, plugs and keys.
- (e) Manual multiple cord switchboard: an arrangement of two or more switchboards which provides for two or more jack appearances for the same station or trunk with interconnection being accomplished in same manner as in (d) above.
- (f) Telephone answering switchboard: an arrangement of jacks for terminating subscriber lines, either as a primary line or an extension of a primary line, for answering purposes only. Answering is accomplished by use of cord circuits equipped with cords, plugs and keys.
- (g) Automatic branch exchange: an arrangement of equipment which provides for interconnection between stations or station to trunk without benefit of an attendant. Calling can be accomplished by rotary dial or U-touch instruments determined by the equipment and central office capabilities.

ISSUED:
July 17, 2002

BY: Warren D. Hannah
Director, Tariffs

EFFECTIVE:
August 1, 2002

GENERAL EXCHANGE TARIFF

UNITED TELEPHONE COMPANY
OF THE WEST
NEBRASKA

Fifth Revised Sheet 14
Cancels Fourth Revised Sheet 14

GENERAL EXPLANATION OF TERMS

PRIVATE BRANCH EXCHANGE SYSTEM (Cont'd)

(g) Automatic branch exchange: an arrangement of equipment ... (Cont'd) (T)

- (1) Cordless turret: a self-contained desk top arrangement of keys, lamps, dial and keyset to provide attendant capability of answering and extending calls.
- (2) Cordless console: a self-contained floor mounted arrangement of keys, lamps, dial and keyset to provide attendant capability of answering and extending calls.
- (3) Cord switchboard: a self-contained floor mounted arrangement of jacks, cords, keys and dial to provide attendant capability of answering and extending calls.

PAYPHONE LINE SERVICE
See Exchange Service.

(D)
(D)

REFERENCE LISTING
See Directory Listing

REGISTERED PROTECTIVE CIRCUITRY
Separate, identifiable and discrete electrical circuitry designed to protect the telephone network from harm, which is registered in accordance with Part 68 or the F.C.C. Rules and Regulations.

REGISTERED TERMINAL EQUIPMENT
Terminal equipment which is registered in accordance with Part 68 of the F.C.C. Rules and Regulations.

RINGING
The term "Ringing" refers to the method of signaling a customer station instrument.

RINGING CIRCUIT
See Private Branch Exchange Service.

ROUTE MEASUREMENT
See Mileage Charges.

(D)
(D)

GENERAL EXCHANGE TARIFF

UNITED TELEPHONE COMPANY OF THE WEST
d/b/a CENTURYLINK
NEBRASKA

Fifth Revised Sheet 15
Cancels Fourth Revised Sheet 15

GENERAL EXPLANATION OF TERMS

SECRETARIAL LINES

Extension lines or main subscriber lines of patrons of a telephone answering bureau which terminate in telephone answering facilities on the premises of the bureau so as to permit the bureau attendant to answer incoming calls on such lines.

SERVICE CONNECTION CHARGE

A non-recurring charge applying to the establishment of service for a subscriber and certain subsequent additions or changes to that service.

SINGLE ENDED TERMINAL DEVICE

A terminal device which terminates only one line or channel at a give time (example - headsets).

SPECIAL DESIGN SERVICE

See Design Service

(N)

(N)

STATION

The network control signaling unit and any other equipment provided at a customer's premise or at Payphone location which enables the sending and/or receiving of communications.

ISSUED:
July 21, 2017

BY: Darlene N. Terry
Manager, Tariffs

EFFECTIVE:
August 1, 2017

GENERAL EXCHANGE TARIFF

UNITED TELEPHONE COMPANY
OF THE WEST
NEBRASKA

Third Revised Sheet 16
Canceling Second Revised Sheet 16

GENERAL EXPLANATION OF TERMS

STATION (Cont'd)

- (a) Company Station: A station owned and maintained by the Company.
- (b) Main Station: A station directly connected by means of an individual **line with** a central office. (C)
- (c) Additional Telephone Instrument: An additional station connected on the same circuit as the main station and subsidiary thereto.
- (d) Private Branch Exchange Station: A station connected with a private branch exchange switchboard or dial switching equipment.
- (e) Private Branch Exchange Additional Telephone Instrument: A telephone set which is bridged to the same line as the PBX station.
- (f) Private Branch Exchange Interior Station: A station that cannot originate or receive local or long distance calls either directly or through an attendant.
- (g) Private Branch Exchange Trunk Line: See Exchange Line.

STATION INSTRUMENT

A station instrument, consisting of a transmitter, receiver and associated apparatus, so connected as to permit sending and receiving telephone messages.

STATION-TO-STATION CALL

See Long Distance Message Telecommunications Service.

SUBSCRIBER

Any person, firm, partnership, corporation, municipality, cooperative organization or governmental agency furnished communication service by the Company under the provisions and regulations of its tariff.

SUPPLEMENTAL CONTRACT

A contract for service, equipment or facilities in addition to that provided for under the original contract.

SUSPENSION OF SERVICE

An arrangement made at the request of the subscriber, or initiated by the Company for violation of tariff regulations by the subscriber, for temporarily interrupting service. During the period of suspension, the Company's equipment remains at the customer's location; the service is rendered inoperable. Facilities are reserved in anticipation that normal service will be resumed at some future date.

ISSUED:
June 16, 2009

BY: Darlene Terry
Manager, Tariffs

EFFECTIVE:
June 26, 2009

GENERAL EXCHANGE TARIFF

UNITED TELEPHONE COMPANY
OF THE WEST
NEBRASKA

Third Revised Sheet 17
Canceling Second Revised Sheet 17

GENERAL EXPLANATION OF TERMS

SYSTEM PREMISES (INSIDE) WIRING

Wiring associated with private branch exchange and key telephone equipment where three or more central office access lines are used in association with the interior wiring between associated equipment. These systems are deregulated as determined in Part 68, of the FCC Rules and Regulations. The three types of System Premises (Inside) Wiring are:

- (1) Fully protected system premises wiring.
- (2) Protected system premises wiring requiring acceptance testing for imbalance.
- (3) Unprotected system premises wiring.

TELECOMMUNICATIONS SERVICE

The services offered by the Company accessing the exchange switching network, including, but not limited to those services covered by the General Exchange, Local Exchange, Long Distance Message Telecommunications Service, Private Line, and Mobile Telephone Service Tariffs.

TELECOMMUNICATIONS SERVICE PRIORITY (TSP)

Denotes the regulatory, administrative, and operational system developed by the Federal Government to ensure priority provisioning and/or restoration of National Security Emergency Preparedness (NSEP) telecommunications services. The Federal Communications Commission (FCC) defines NSEP telecommunications services as those services which are used to maintain a state of readiness or to respond to and manage any event or crisis, which causes or could cause harm to the population, damage to or loss of property, or degrades or threatens the NSEP posture of the United States. The TSP System's applicability is limited to telecommunication services which the Telephone Company can discretely identify for priority provisioning and/or restoration. See Section 13 of the Access Service Tariff for regulations, rates and charges.

(N)

(N)

TELEPHONE NUMBER

A designation assigned to a main station, central office line, or trunk for convenience in placing calls for identification in the assessment of message charges, etc.

TELEPHONE OR TELECOMMUNICATIONS NETWORK

The local telephone exchange and long distance message telecommunications facilities, or network; both inter and intrastate.

ISSUED:
March 25, 1991

BY: Warren D. Hannah
Director, Local Tariffs

EFFECTIVE:
March 25, 1991

GENERAL EXCHANGE TARIFF

UNITED TELEPHONE COMPANY
OF THE WEST d/b/a CenturyLink
NEBRASKA

Sixth Revised Sheet 18
Cancels Fifth Revised Sheet 18

GENERAL EXPLANATION OF TERMS

TELETYPEWRITER

An electrically controlled form of a typewriter upon which typewritten messages may be sent and received between similar teletypewriters when connected by wire circuit.

TEMPORARY DISCONNECTION

See Suspension of Service.

TERMINATION CHARGE

A charge made to liquidate a subscriber's obligations for termination of service prior to the expiration of the initial contract period.

TIE LINE MEASUREMENT (MILEAGE)

See Mileage Charges.

TOLL MESSAGE

See Message.

TOLL RESTRICTION

A service that enables the customer, by means of Telephone Company operator identification, to restrict outgoing toll calls from station users and prohibits the charging of calls to the customer's telephone number(s) via alternate billing arrangements, such as third number or collect billing.

TOLL SERVICE

See Long Distance Message Telecommunications Service.

TOLL TERMINAL SERVICE

A service arrangement through which long distance service only is furnished.

U-TOUCH CALLING SERVICE

See Exchange Service.

(D)

(D)

ISSUED:
November 30, 2018

BY: Darlene Terry
Manager, Tariffs

EFFECTIVE:
December 10, 2018

GENERAL EXCHANGE TARIFF

UNITED TELEPHONE COMPANY
OF THE WEST
NEBRASKA

SECTION 1
Second Revised Sheet 1
Canceling First Revised Sheet 1

PAYMENT OF BILLS, ADVANCE PAYMENTS AND DEPOSITS

(T)

A. ADVANCE PAYMENTS

1. In accordance with the Telephone Company's practice of requiring that all regularly recurring charges for services, equipment, and facilities be paid monthly in advance, an applicant for telephone service, except as modified by Paragraph A-3 below, will be required to pay in advance at the time application for service is made, the service connection charges applicable, together with at least one month's charges for the services, equipment, and facilities applied for, and where necessary, in the opinion of the Telephone Company, the estimated amount of construction and installation charges.
2. The amount of the advance payment will be credited to the subscriber's account and applied to any indebtedness under the contract for services, equipment, and facilities furnished, for service connection, move, and change charges, and for toll messages.
3. Advance payments will not ordinarily be required at the time of application for new service in the case of government departments or other applicants whose credit is known to be satisfactory. Present subscribers whose credit is satisfactory in the exchange in which they have service will not be required to make advance payments at the time of applications for new service in the same exchange or elsewhere; nor in the case of moves of, additions to, or changes in their present equipment or service.

B. DEPOSITS

1. When the Telephone Company deems it necessary, in protecting its earned revenues, an applicant for service or a present subscriber may be required to make and keep intact a deposit in such amount as may be required from time to time by the Telephone Company as a guarantee of the payment of charges for services rendered. The fact that a deposit has been made shall in no way relieve the applicant or subscriber from complying with the regulation of the Telephone Company as to advance payments and the prompt payment of bills on presentation, nor constitute a waiver or modification of the regular practices of the Telephone Company providing for the discontinuance of service for non-payment of any sums due the Telephone Company for service rendered.
 - a. Lifeline subscribers, who voluntarily elect to receive Toll Restriction, are not required to pay a service deposit.
2. The deposit will bear simple interest at 7 per cent a year payable on the actual amount on deposit with the Telephone Company.
3. When the service is terminated, the amount of the deposit with interest computed from the date of its receipt by the Telephone Company to the date of discontinuance of service will be returned to the subscriber less such sums as may be due the Telephone Company for services rendered. However, if the Telephone Company deems the deposit no longer necessary, it may return the deposit prior to the discontinuance of service, in which case interest will be computed to the date of the notice to the subscriber that the deposit will be returned to him.
4. When charges for construction work are applicable, such as charges for underground entrance construction or aerial or pole line construction, such charges shall be collected in advance if such procedure seems advisable. In such cases where charges are to be based on the cost of labor and material required, the advance payment may be estimated and collected. Such adjustments as are necessary may then be made when the work has been completed.
5. If it is deemed necessary by the Telephone Company, house movers may be required to make a deposit before permission is given to proceed with the work. In such cases the amount of the advance payment or deposit may be estimated and collected. Such adjustments as are necessary may then be made when the work has been completed.

ISSUED:
December 29, 2022

BY: Terri Million
Director, Tariffs

EFFECTIVE:
January 10, 2023

NEB-2022-01

Received by NPSC
12/28/2022

GENERAL EXCHANGE TARIFF

UNITED TELEPHONE COMPANY
OF THE WEST d/b/a CenturyLink
NEBRASKA

Section 1
Third Revised Sheet 2
Cancels Second Revised Sheet 2

PAYMENT OF BILLS, ADVANCE PAYMENTS AND DEPOSITS (T)

C. PAYMENT OF BILLS (N)

1. Paper Bill Fee

Residential and small business customers who receive a paper bill will incur a \$1.00 monthly Paper Bill Fee. Lifeline and Affordable Connectivity Program customers, and customers who receive Braille or large print invoices are excluded from this fee. (N)

ISSUED:
December 29, 2022

BY: Terri Million
Director, Tariffs

EFFECTIVE:
January 10, 2023

NE2023-02

Received by NPSC
12/28/2022

GENERAL EXCHANGE TARIFF

UNITED TELEPHONE COMPANY
OF THE WEST
NEBRASKA

SECTION 2
Fourth Revised Sheet 1
Cancels Third Revised Sheet 1

APPLICATION OF RATES FOR BUSINESS AND RESIDENCE SERVICE
AND COMBINED ACCESS LINE SERVICE

A. APPLICATION OF RATES FOR BUSINESS AND RESIDENCE SERVICE

1. Determination as to whether a subscriber's service should be classified as business or residence service is based upon whether the primary or dominant character of the use which is to be made of the service is for business, professional, or occupational purposes, or for social or domestic purposes.
2. Rates for business service apply where more than a very incidental portion of the service is for business or occupational purposes, or for the administration of the activities of such institutions as clubs, hospitals, schools, colleges, churches, fraternal orders, and charitable organizations. **Rates for business service also apply at residential locations where the customer requests a Call Forward Feature for more than five (5) residential lines to simulate Rotary Hunt Service, at the same or different residential locations. In such instances, business rates applicable for Rotary Hunt Service apply.**
3. Rates for residence service apply where the primary or dominant character of the use is of a social or domestic nature and other use if any, is merely incidental.
 - a. **Lodge Rooms and Halls**
Rooms and halls utilized by lodges, fraternal organizations, or other associations, for meeting purposes, which are open only during such time as meetings are being held and which do not have associated with them club rooms which are open to members at other than times of meetings, will be furnished access line exchange service at a rate equal to the individual line residence rate applicable at that location. Individual line service will be furnished at the individual line residence rate applicable at that location.
4. While the location at which service is furnished is, in most cases, a guide to the character of use, and rates for business and residence service generally are applied on this basis, the character of use is controlling in all instances regardless of the location.

(N)
|
(N)

B. COMBINED ACCESS LINE SERVICE (ALSO SEE SECTION 16)

1. Two individual access lines may be so connected and equipped that a signal may be received at the other, when either of them is called, thereby furnishing secretarial service when either of the locations is not attended.
2. Flat rate and Payphone Line or other message rate services are not combined. Ordinarily, two services are combined only when they are subscribed for by the same subscriber or when one subscriber is in business with or is an employee or agent of the other subscriber.

ISSUED:
May 26, 2009

BY: Darlene N. Terry
Manager, Tariffs

MAY 26 2009
EFFECTIVE:
June 5, 2009

GENERAL EXCHANGE TARIFF

UNITED TELEPHONE COMPANY
OF THE WEST
NEBRASKA

SECTION 2
First Revised Sheet 1A
Canceling Original Sheet 1A

APPLICATION OF RATES FOR BUSINESS AND RESIDENCE SERVICE
AND COMBINED ACCESS LINE SERVICE

B. COMBINED ACCESS LINE SERVICE (ALSO SEE SECTION 16) (Cont'd)

3. When the access lines are located within the same single office area or within the same central office district of a multi-office exchange, the total of rates for individual line service apply. In addition, when the access lines are located in different central office districts of a multi-office exchange, regular extension service mileage charges (See Section 8) apply for the air-line distance between the central office buildings serving the two districts in which the access lines are located.
- (D)
- (D)
- (D)

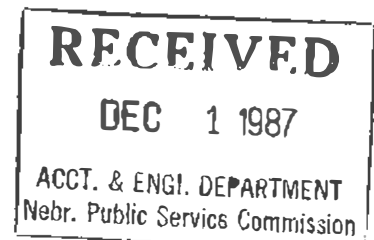

ISSUED:

BY: I. B. Watson
Vice President - Administration
6666 West 110th Street
Overland Park, Kansas 66211

EFFECTIVE:

GENERAL EXCHANGE TARIFF

UNITED TELEPHONE COMPANY
OF THE WEST d/b/a CenturyLink
NEBRASKA

Section 2
Original Sheet 2

ADVANCE PAYMENTS AND DEPOSITS

3. CONVENIENCE FEE CHARGE

A Convenience Fee Charge will apply to residential and business customers for one-time payments made with the assistance of a live customer representative using a debit card, a credit card or an electronic funds transfer. Payments for a deposit or advance payment to establish new service are excluded from the Convenience Fee Charge. This charge does not apply to customers who are enrolled in automatic payment plans, who pay their bill by mail, who use the automatic voice response unit, who use their financial institution's bill payment service, or who pay their bills online at the Company's website.

	<u>Non-Recurring Charge</u>
Convenience Fee Charge, per occasion, utilizing a live customer representative	\$4.00



ISSUED:
July 5, 2013

BY: Darlene Terry
Manager, Tariffs

NE13-05

GENERAL EXCHANGE TARIFF

UNITED TELEPHONE COMPANY
OF THE WEST d/b/a CenturyLink
NEBRASKA

SECTION 3
Third Revised Sheet 1
Cancels Second Revised Sheet 1

CONSTRUCTION CHARGES AND OTHER SPECIAL CHARGES

A. **CONCURRENCE**

Terms and conditions for Construction Charges and Other Special Charges concur with those found in section 4 of the [Nebraska Qwest Corporation d/b/a CenturyLink QC Exchange and Network Services Catalog](#).

(T)

(C)

(C)

(D)

(D)

ISSUED:
May 22, 2020

BY: Darlene Terry
Manager, Tariffs

EFFECTIVE:
June 1, 2020

NE2020-04

Received by NPSC
05/22/2020

GENERAL EXCHANGE TARIFF

UNITED TELEPHONE COMPANY
OF THE WEST d/b/a CenturyLink
NEBRASKA

SECTION 3
Fifth Revised Sheet 2
Cancels Fourth Revised Sheet 2

CONSTRUCTION CHARGES AND OTHER SPECIAL CHARGES

B. **RESERVED**

(T)

(C)

(D)

(D)

ISSUED:
May 22, 2020

BY: Darlene Terry
Manager, Tariffs

EFFECTIVE:
June 1, 2020

NE2020-04

Received by NPSC
05/22/2020

GENERAL EXCHANGE TARIFF

UNITED TELEPHONE COMPANY
OF THE WEST d/b/a CenturyLink
NEBRASKA

SECTION 3
Fourth Revised Sheet 3
Cancels Third Revised Sheet 3

CONSTRUCTION CHARGES AND OTHER SPECIAL CHARGES

(T)

B. **RESERVED (Cont'd)**

(C)

(D)

(D)

ISSUED:
May 22, 2020

BY: Darlene Terry
Manager, Tariffs

EFFECTIVE:
June 1, 2020

NE2020-04

Received by NPSC
05/22/2020

GENERAL EXCHANGE TARIFF

UNITED TELEPHONE COMPANY
OF THE WEST d/b/a CenturyLink
NEBRASKA

SECTION 3
First Revised Sheet 4
Cancels Original Sheet 4

CONSTRUCTION CHARGES AND OTHER SPECIAL CHARGES

(T)

B. **RESERVED (Cont'd)**

(C)

(D)

(D)

ISSUED:
May 22, 2020

BY: Darlene Terry
Manager, Tariffs

EFFECTIVE:
June 1, 2020

NE 2020-04

Received by NPSC
05/22/2020

GENERAL EXCHANGE TARIFF

UNITED TELEPHONE COMPANY
OF THE WEST
NEBRASKA

Section 4
Second Revised Sheet 1
Cancels First Revised Sheet 1

DIRECTORY LISTINGS

A. GENERAL

1. Following are rates and regulations for directory listings, applicable in connection with primary and additional listings in the alphabetical telephone directory.
2. The alphabetical telephone directory is an alphabetical list, with telephone numbers, of **subscribers and** others who are entitled to use the subscriber's telephone service under the rules and regulations governing such use, as specified hereinafter. Such listings are arranged alphabetically by surname, business name, or corporate name. The alphabetical directory is designed solely for the purpose of informing calling parties of the telephone numbers of those parties entitled to be listed therein. (C)
3. Special prominence or arrangement of names is not permitted, nor any form of listing which does not facilitate directory service, or is otherwise objectionable, or unnecessary for purposes of identification. The listing of a service, commodity or trade name as such will, in no case, be permitted except when the name of the service, commodity or trade name is the name, or an integral part of the name under which the listed party is doing business.
4. Applicants for directory listings comprising copyrighted names, which have been referred specifically to the Telephone Company by those persons or firms who control the proprietary rights therein, are required to furnish proof of their right to the use of such names prior to their acceptance for directory listing purposes. Directory listings comprised of copyrighted names are discontinued upon notice from the persons or firms controlling the proprietary rights therein, unless the parties using such listings furnish satisfactory proof as to their right to the use of such names for directory listing purposes. Where action of a court has restricted use of a name, its use by other than authorized persons or firms is not permitted.
5. The length of any listing is shortened by the use of abbreviations, where the clearness of the listing or the identification of the listed party is not impaired thereby. Where more than one line is required in the opinion of the Telephone Company, to list a customer properly, no additional charge is made.

ISSUED:
June 16, 2009

BY: Darlene Terry
Manager, Tariffs

EFFECTIVE:
June 26, 2009

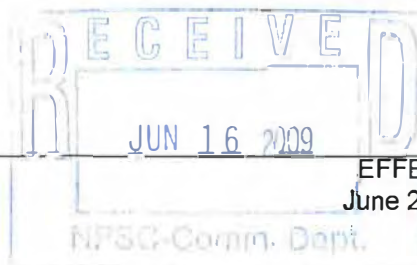

GENERAL EXCHANGE TARIFF

UNITED TELEPHONE COMPANY
OF THE WEST
NEBRASKA

Section 4
First Revised Sheet 1A
Cancels Original Sheet 1A

DIRECTORY LISTINGS (Cont'd)

A. GENERAL (Cont'd)

6. When a customer desires a listing which contains service matter or informative material in addition to the proper name, standard designation, address, and telephone number, and the inclusion of such informative material results in the use of an "extra line" or lines in the directory, such additional matter, properly abbreviated, will be included, where considered proper by the Telephone Company, and the regular additional listing rate will apply for each such extra line required.
7. All listings must conform to the Telephone Company's specifications with respect to such listings.
8. Listings are provided regularly in connection with all classes of exchange service, except ***Payphone Line Service.***

(T)

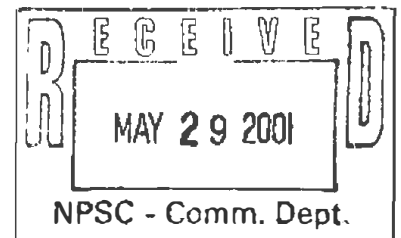

ISSUED:
May 29, 2001

BY: Warren D. Hannah
Director, Local Tariffs

EFFECTIVE:
June 8, 2001

GENERAL EXCHANGE TARIFF

UNITED TELEPHONE COMPANY
OF THE WEST
NEBRASKA

Section 4
Seventh Revised Sheet 2
Cancels Sixth Revised Sheet 2

DIRECTORY LISTINGS

B. PRIMARY LISTINGS

1. One listing without charge, termed the "primary" listing, is furnished as an integral part of the telephone service, and the name, address, and telephone call number in this primary listing must be the same as that used in contracting for the service. When two or more lines or trunks serve a customer in a group for "trunk-hunting" operations, all such lines so arranged constitute one telephone call number and are entitled to but one primary listing without charge.
2. Customers for exchange service are, without additional charge, furnished primary listings in the alphabetical directory covering the area from which their service is provided, as follows:

- | | | |
|----|---|-----------|
| a. | Residence service, each access line | 1 listing |
| b. | Business Service, each access line ⁽¹⁾ | 1 listing |
| c. | Private Branch Exchange service, each system ⁽¹⁾ | 1 listing |

(D)
|
(D)
|
(T)
|
(T)

⁽¹⁾ See Paragraph B.1., immediately preceding.

(T)

ISSUED:
June 16, 2009

BY: Darlene Terry
Manager, Tariffs

JUN - 16 - 2009
Nebraska Comm. Dept.

EFFECTIVE:
June 26, 2009

GENERAL EXCHANGE TARIFF

UNITED TELEPHONE COMPANY
OF THE WEST d/b/a CenturyLink
NEBRASKA

Section 4
Twenty-First Revised Sheet 2a
Cancels Twentieth Revised Sheet 2a

DIRECTORY LISTINGS

B. PRIMARY LISTINGS (Cont'd)

3. A listing furnished in connection with business service includes the business designation requested, unless the name is sufficiently descriptive so that a further designation is not required for proper identification.

4. A customer's listing may be omitted from the directory but otherwise posted on the information records ("non-listed"), and connections will be handled in the same manner as with other service, if he requests such an arrangement. The monthly charge will be:

Directory, Non-Listed	<u>Monthly Rate</u>
Residence and Business	\$11.00 (I)

5. A customer's listing may be omitted from the directory and the information records ("non-published"), and connections with such service will be established only when the telephone call number is furnished by the calling party. The monthly charge will be:

Directory, Non-Published	<u>Monthly Rate</u>
Residence and Business	\$11.00 (I)

6. A customer requesting non-listed or non-published service due to personal safety concerns (stalking, domestic violence, sexual assault, etc.) will be provided Non-Listed or Non-Published service free of charge. Customer may be required to provide documentation of eligibility. Examples of acceptable documentation are participation in a state-administered address confidentiality program or a court-ordered protective order.

7. Utilization of Call Trace

Parties with non-published numbers forfeit the privacy afforded by the service to the extent that the telephone number is identified through activation of a Call Trace and/or Call Line Identifier procedures whereby the name and address of the subscriber will be provided to the authorized law enforcement agency upon request of the agency.

ISSUED:
January 20, 2023

BY: Terri Million
Director, Tariffs

EFFECTIVE:
February 1, 2023

NE2023-05

Received by NPSC
01/18/2023

GENERAL EXCHANGE TARIFF

UNITED TELEPHONE COMPANY
OF THE WEST
NEBRASKA

Section 4
Third Revised Sheet 3
Cancels Second Revised Sheet 3

DIRECTORY LISTINGS

C. ADDITIONAL LISTINGS

1. Additional listings (i.e., all listings in excess of those provided without additional charge) are divided into two main classes, namely: "Regular Additional Listings" and "Special Additional Listings."
2. Charges for additional listings date from the day information records are posted. Such posting may be done upon receipt of the order for the listing, or as of the date of issue of the directory in which the listing first will appear, whichever is requested by the subscriber.
3. Ordinarily, all additional listings must be of the same address and telephone number as the primary listing, except as provided below for alternate listings. However, when it appears necessary as an aid to the use of the directory, and provided satisfactory service can be furnished, a listing may be permitted with the off-premise address of a private branch exchange station, or push-button telephone station equipped for intercommunication with the primary service address, provided the secondary service address is on premises likewise occupied by the **subscriber**. **Likewise** an additional listing may be permitted for the same address, but using a different regularly-assigned telephone number, where the same firm or its members are using split telephone numbers on other than a trunk-hunting basis. (C)
4. For the minimum contract period, and regulations covering the termination of directory additional listings, see Section 7 of the General Exchange Tariff, "Initial Service Periods and Termination of Service."
5. Additional Listings
 - a. Business additional listings are listings, in excess of those provided without additional charge, furnished in connection with business service and may be the names of members of the firm, if the **subscriber is** a firm; the names of officers of the corporation, if the **subscriber is** a corporation; and, for any business establishment, the names of the employees or representatives of the **subscriber**. (C)
(C)
(C)

ISSUED:
June 16, 2009

BY: Darlene Terry
Manager, Tariffs

RECEIVED
JUN 16 2009
NPSC C n Dan

EFFECTIVE:
June 26, 2009

GENERAL EXCHANGE TARIFF

UNITED TELEPHONE COMPANY
OF THE WEST
NEBRASKA

Section 4
Third Revised Sheet 3A
Cancels Second Revised Sheet 3A

DIRECTORY LISTINGS

C. ADDITIONAL LISTINGS (Cont'd)

5. Additional Listings (Cont'd)

- b. Business additional listings likewise may be the names of firms, persons, corporations, associations or institutions which the **subscriber owns**, controls or represents. Listings which are designated primarily to give publicity to a commodity or service are not permitted in the alphabetical directory. (C)

NOTE: "Representation" is defined as the relationship which exists when one acts as the Agent for another. It does not include cases where one sells commodities or perform services but, in so doing, acts for himself and not as the Agent for another.

- c. Business additional listings are not permitted in connection with residence service.
- d. The Telephone Company may require evidence of consent to the use of names other than that of the subscriber.
- e. Residence additional listings are listings, in excess of those provided without additional charge, furnished in connection with residence service and may be the names of members of the subscriber's family, or of other persons residing in the subscriber's household as a part of such household; permanent guests or tenants who maintain their residence in a family hotel, transient hotel or club where the service of such guests or tenants is provided through the private branch exchange of the hotel or club; permanent guests or tenants who maintain their residences in a boarding or rooming house where service is provided by means of Payphone Line Service; or members of a group who maintain permanent residence under group management without profit to any one member, as in the case of bachelor quarters or in college fraternity or sorority houses.

ISSUED:
June 16, 2009

BY: Darlene Terry
Manager, Tariffs

June 26,

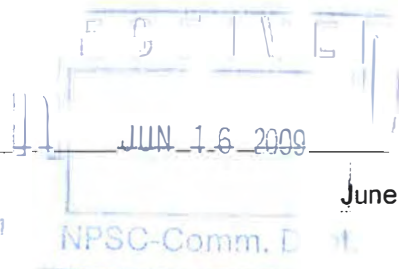

GENERAL EXCHANGE TARIFF

UNITED TELEPHONE COMPANY
OF THE WEST d/b/a CenturyLink
NEBRASKA

Section 4
Fourteenth Revised Sheet 4
Cancels Thirteenth Revised Sheet 4

DIRECTORY LISTINGS

C. ADDITIONAL LISTINGS (Cont'd)

5. Additional Listings (Cont'd)

- f. The names of persons leasing or sub-leasing premises of subscribers, who are absent temporarily from such premises, also may be accepted as residence additional listings, as provided for hereinafter under "Temporary Listings of Tenants Sub-Leasing Subscriber's Premises".
- g. Residence additional listings do not include business or professional designations, nor do they contain designations of title except where such title designations are necessary as a means of identifying the listed party properly.
- h. Where business service is located in a residence, it is permissible to provide residence additional listings in connection with such business service.
- i. Regular additional listings may be extra alphabetical listings or sub-listings, appearing below the main listing, to which calls are referred on an alternate basis, during such times as the main office service is not functioning on a normally scheduled basis.

Example:

Farr Wyoming Co RR & West B 632-2244
 After 6 p.m. & Sunday call:
 Manager..... 632-3560
 Buyer..... 632-3880

NOTE: No charge applies for that portion of a listing such as: "Nights, Sundays, and Holidays, Call" designating periods for calling certain numbers when it is used only for referring to listings shown in succeeding lines and contains no telephone number information.

- j. The monthly charge for each regular additional alphabetical listing is:

Additional Listing	<u>Monthly Rate</u>
Per Listing, Residence/Business	\$8.00 (I)

- k. For Night, Sunday and Holiday Service furnished by means of an additional specially assigned number terminal bridged with the regular number, see rates and regulations in Section 14, "Private Branch Exchange Service."

ISSUED:
October 30, 2020

BY: Darlene Terry
Directory, Tariffs

EFFECTIVE:
January 1, 2021

NE2021-01

Received by NPSC
01/15/2021

GENERAL EXCHANGE TARIFF

UNITED TELEPHONE COMPANY
OF THE WEST d/b/a CenturyLink
NEBRASKA

Section 4
Thirteenth Revised Sheet 4a
Cancels Twelfth Revised Sheet 4a

DIRECTORY LISTINGS

C. ADDITIONAL LISTINGS (Cont'd)

5. Additional Listings (Cont'd)

I. Regular additional listings may be provided by the Telephone Company without charge in certain cases where such listings are, in the opinion of the Telephone Company, unquestionably essential to the convenient use of the service by customers generally. If the listing has a commercial value to the listed customer, regular charges apply.

6. Special Additional Listings

a. Alternate Listings

(1) Alternate listings are sublistings, appearing below the main listings, and these contain alternate telephone numbers to which calls are referred when no answer is received at the primary station:

(a) Example:
Lane Coal 214 West 14 632-1234
If no answer call 436-4351

(b) Example:
Smith J C MD 2807 Ave D 632-2431
Res. 1112 Schmid Drive 632-3362
If no answer call 436-3415

(2) The monthly charge for each alternate listing is:

Alternate Listing	<u>Monthly Rate</u>
Per Listing, Residence/Business	\$8.00 (I)

(3) If the alternate number is that of a service not under contract by the subscriber under whose name it appears, the Telephone Company may demand written consent of the contract for the service, before the alternate listing is provided.

ISSUED:
October 30, 2020

BY: Darlene Terry
Directory, Tariffs

EFFECTIVE:
January 1, 2021

NE2021-01

Received by NPSC
01/15/2021

GENERAL EXCHANGE TARIFF

UNITED TELEPHONE COMPANY
OF THE WEST
NEBRASKA

Section 4
First Revised Sheet 5A
Cancels Original Sheet 5A

DIRECTORY LISTINGS

C. ADDITIONAL LISTINGS (Cont'd)

6. Special Additional Listings (Cont'd)

d. Temporary Listings of Tenants Sub-Leasing Subscriber's Premises (Cont'd)

- (2) The subscriber may obtain additional listings for such persons, if he so desires, at the regular rate for regular residence additional listings.
- (3) This special arrangement is provided only where the subscriber retains his interest in the premises and where he is to be absent only temporarily from such premises. It is not intended under this arrangement that both the subscriber and the temporary tenants mentioned herein shall occupy the premises, and be listed therein, at the same time.

(D)

(D)

ISSUED:
June 16, 2009

BY: Darlene Terry
Manager, Tariffs

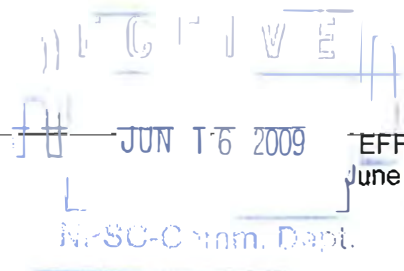

EFFECTIVE:
June 26, 2009

GENERAL EXCHANGE TARIFF

UNITED TELEPHONE COMPANY
OF THE WEST
NEBRASKA

Section 4
Fifth Revised Sheet 6
Cancels Fourth Revised Sheet 6

DIRECTORY LISTINGS

This Page is Reserved for Future Use

(T)

(D)

(D)

ISSUED:
June 16, 2009

BY: Darlene Terry
Manager, Tariffs

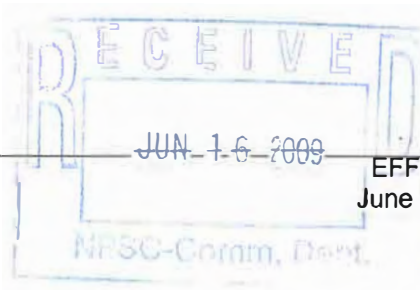

EFFECTIVE:
June 26, 2009

GENERAL EXCHANGE TARIFF

UNITED TELEPHONE COMPANY
OF THE WEST
NEBRASKA

Section 4
Original Sheet 7

DIRECTORY LISTINGS (Cont'd)

D. DUAL-NAME LISTINGS

1. Dual-name listings are defined as a combination of names and/or initials of two individuals with the same or different surname(s), residing at the same address or of one person known by two sets of first and/or middle names and/or initials.
2. The following examples illustrate the format options for dual-name listings:

a. PRIMARY LISTING

Jones, John & Mary	123 Main St	Anytown 12345	123 456-7890
or			
Jones, John T & Mary F	123 Main St	Anytown 12345	123 456-7890
or			
Jones, Mary F	123 Main St	Anytown 12345	123 456-7890
or			
Jones, John T Mrs	123 Main St	Anytown 12345	123 456-7890
or			
Jones, John & Mary Smith	123 Main St	Anytown 12345	123 456-7890
or			
Jones, John & Tom Smith	123 Main St	Anytown 12345	123 456-7890

b. PRIMARY WITH ADDITIONAL LISTING(s)

Jones, John T	123 Main St	Anytown 12345	123 456-7890
Jones, Mary F & John T	123 Main St	Anytown 12345	123 456-7890
Jones, John T Tex	123 Main St	Anytown 12345	123 456-7890
Jones, John & Mary Smith	123 Main St	Anytown 12345	123 456-7890
Smith, Mary	123 Main St	Anytown 12345	123 456-7890
Jones, John & Tom Smith	123 Main St	Anytown 12345	123 456-7890
Smith, Tom	123 Main St	Anytown 12345	123 456-7890



GENERAL EXCHANGE TARIFF

UNITED TELEPHONE COMPANY
OF THE WEST
NEBRASKA

Section 4
First Revised Sheet 8
Cancels Original Sheet 8

DIRECTORY LISTINGS (Cont'd)

D. DUAL-NAME LISTINGS (Cont'd)

3. Dual-name listings are available only for residence subscribers.
4. Dual-name listings may be provided as the primary listing at no monthly recurring charge for the addition of the second name to the listing.
5. Dual-name listings may be provided as an additional listing at the customer's option at the regular additional listing rate.
6. A service charge as specified in Section 18 applies for:
 - a. Changing a primary single-name directory listing to a primary dual-name directory listing.
 - b. Changing the primary or additional dual-name directory listing once established.
 - c. Changing an additional dual-name directory listing to a primary dual-name directory listing.
7. No nonrecurring charge applies when the dual-name listing is established with the initial establishment of service or when a change in an existing listing is requested on an order for which service charges are otherwise applicable.

E. **AUXILIARY LISTINGS**

Auxiliary listings, which provide supplemental business or residence information, will be provided without charge upon customer request when the number of auxiliary listings requested does not exceed the number of access lines billed under a single bill. If the auxiliary listing uses the same name as the primary listing, the primary listing and the auxiliary listing must be in the caption together. Auxiliary listings may not be used to reprint the main telephone number under a different name. If an auxiliary listing is published more than once, the second listing will be charged at the rate for an additional listing.

(N)
|
(N)

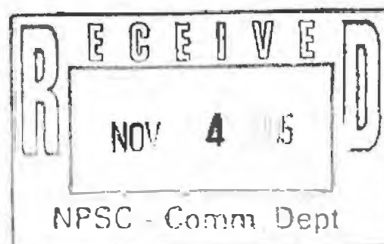

GENERAL EXCHANGE TARIFF

UNITED TELEPHONE COMPANY
OF THE WEST d/b/a CenturyLink
NEBRASKA

Section 4
Sixth Revised Sheet 9
Cancels Fifth Revised Sheet 9

DIRECTORY LISTINGS

F. VANITY LISTINGS

1. Where available, a subscriber may request to have the assigned telephone number published in the telephone directory in upper case alpha form, i.e., "333-THIS", rather than 333-8447. Use of Vanity Listings is not exclusive to any single subscriber. The letters "Q" and "Z" are not available nor may the "#" or "*" symbols be used with this service. The numbers "0" or "1" may not be used to represent the letters "O" or "I", respectively, in a Vanity Listing.
2. Prior to establishing a Vanity Listing, the Company reserves the right to require, when necessary in its sole discretion, satisfactory evidence from the subscriber that the subscriber is authorized to use any trade name, business name, or any other name or term, requested by the subscriber, which is copyrighted or otherwise reserved.
3. Provisioning of a Vanity Listing is based upon the current availability of that telephone number. The Company reserves the right to exclude certain numbers or blocks of numbers from assignment, and will determine the availability criteria in its sole discretion. No customer waiting lists will be maintained. The Company reserves the right to reject any listing or number, which in its sole discretion, may be considered objectionable or would tend to delay or impede the use of the directory.
4. The Company will not be a party to any controversy or conflict between customers as a result of the Vanity Listing.
5. The customer shall have no property right in the Vanity Listing, and the number shall remain the property of the Company. The Company reserves the right to change the Vanity Listing in its sole discretion. The Company is not liable for any kind of monetary or damage claims due to errors, omissions, or customer problems associated with Vanity Listings.
6. Vanity Listings may be listed in the Company directories white pages at the rates provided in this Section. Customers wanting the Vanity Listing will be charged the Vanity Listing rate in addition to the applicable nonrecurring rates. Customers wanting the numeric equivalent of the Vanity Listing to also be listed as their primary listing will not be charged an additional monthly recurring charge but will be assessed the appropriate nonrecurring rate if the numeric equivalent is added by a subsequent order. When listed, the numeric equivalent of the Vanity Listing will immediately follow the alpha listing in the directory. Only the numerical listing shall be available from Directory Assistance.

7. Rates and Charges	<u>Monthly Rate</u>
Per Vanity Listing, Residence/Business	\$8.00 (I)

ISSUED:
October 30, 2020

BY: Darlene Terry
Directory, Tariffs

EFFECTIVE:
January 1, 2021

NE2021 01

Received by NPSC
01/15/2021

GENERAL EXCHANGE TARIFF

UNITED TELEPHONE COMPANY
OF THE WEST
NEBRASKA

Section 5
Third Revised Sheet 1
Canceling Second Revised Sheet 1

Information previously found in this section has been moved to Section 5 of the General Exchange Price List.

(D)

RECEIVED

MAY 12 1993

ACCT. & ENGI. DEPARTMENT
Nebr. Public Service Commission

(D)

ISSUED: May 12, 1993

EFFECTIVE: May 22, 1993

BY: J. L. Roe
Vice President Administration
5454 West 110th Street
Overland Park, Kansas 66211

GENERAL EXCHANGE TARIFF

UNITED TELEPHONE COMPANY
OF THE WEST
NEBRASKA

Section 5
Second Revised Sheet 2
Canceling First Revised Sheet 2

Information previously found in this section has been moved to Section 5 of the General Exchange Price List.

(D)

RECEIVED

MAY 12 1993

ACCT. & ENGI. DEPARTMENT
Nebr. Public Service Commission

(D)

ISSUED: May 12, 1993

EFFECTIVE: May 22, 1993

BY: J. L. Roe
Vice President Administration
5454 West 110th Street
Overland Park, Kansas 66211

GENERAL EXCHANGE TARIFF

UNITED TELEPHONE COMPANY
OF THE WEST
NEBRASKA

Section 5
Second Revised Sheet 3
Canceling First Revised Sheet 3

Information previously found in this section has been moved to Section 5 of the General Exchange Price List.

(D)

RECEIVED

MAY 12 1993

ACCT. & ENGI. DEPARTMENT
Nebr. Public Service Commission

(D)

ISSUED: May 12, 1993

EFFECTIVE: May 22, 1993

BY: J. L. Roe
Vice President Administration
5454 West 110th Street
Overland Park, Kansas 66211

GENERAL EXCHANGE TARIFF

UNITED TELEPHONE COMPANY
OF THE WEST
NEBRASKA

Section 5
First Revised Sheet 4
Canceling Original Sheet 4

Information previously found in this section has been moved to Section 5 of the General Exchange Price List.

(D)

RECEIVED
MAY 12 1993
ACCT. & ENCL. DEPARTMENT
Nebr. Public Service Commission

(D)

ISSUED: May 12, 1993

EFFECTIVE: May 22, 1993

BY: J. L. Roe
Vice President Administration
5454 West 110th Street
Overland Park, Kansas 66211

GENERAL EXCHANGE TARIFF

UNITED TELEPHONE COMPANY
OF THE WEST
NEBRASKA

Section 5
First Revised Sheet 5
Canceling Original Sheet 5

Information previously found in this section has been moved to Section 5 of the General Exchange Price List.

(D)

RECEIVED

MAY 12 1993

ACCT. & ENCL. DEPARTMENT
Nabr. Public Service Commission

(D)

ISSUED: May 12, 1993

EFFECTIVE: May 22, 1993

BY: J. L. Roe
Vice President Administration
5454 West 110th Street
Overland Park, Kansas 66211

GENERAL EXCHANGE TARIFF

UNITED TELEPHONE COMPANY
OF THE WEST
NEBRASKA

Section 5
First Revised Sheet 6
Canceling Original Sheet 6

Information previously found in this section has been moved to Section 5 of the General Exchange Price List.

(D)

RECEIVED

MAY 12 1993

ACCT. & ENCL. DEPARTMENT
Nebr. Public Service Commission

(D)

ISSUED: May 12, 1993

EFFECTIVE: May 22, 1993

BY: J. L. Roe
Vice President Administration
5454 West 110th Street
Overland Park, Kansas 66211

GENERAL EXCHANGE TARIFF

UNITED TELEPHONE COMPANY
OF THE WEST
NEBRASKA

Section 5
First Revised Sheet 7
Canceling Original Sheet 7

Information previously found in this section has been moved to Section 5 of the General Exchange Price List.

(D)

RECEIVED

MAY 12 1993

**ACCT. & ENCL. DEPARTMENT
Nebr. Public Service Commission**

(f)

ISSUED: May 12, 1993

EFFECTIVE: May 22, 1993

BY: J. L. Roe
Vice President Administration
5454 West 110th Street
Overland Park, Kansas 66211

GENERAL EXCHANGE TARIFF

UNITED TELEPHONE COMPANY
OF THE WEST
NEBRASKA

Section 5
First Revised Sheet 8
Canceling Original Sheet 8

Information previously found in this section has been moved to Section 5 of the General Exchange Price List.

(D)

RECEIVED

MAY 12 1993

ACCT. & ENGR. DEPARTMENT
Nebr. Public Service Commission

(D)

ISSUED: May 12, 1993

EFFECTIVE: May 22, 1993

BY: J. L. Roe
Vice President Administration
5454 West 110th Street
Overland Park, Kansas 66211

GENERAL EXCHANGE TARIFF

UNITED TELEPHONE COMPANY
OF THE WEST
NEBRASKA

Section 5
First Revised Sheet 9
Canceling Original Sheet 9

Information previously found in this section has been moved to Section 5 of the General Exchange Price List.

(D)

RECEIVED

MAY 12 1993

ACCT. & ENCL. DEPARTMENT
Nebr. Public Service Commission

(D)

ISSUED: May 12, 1993

EFFECTIVE: May 22, 1993

BY: J. L. Roe
Vice President Administration
5454 West 110th Street
Overland Park, Kansas 66211

GENERAL EXCHANGE TARIFF

UNITED TELEPHONE COMPANY
OF THE WEST
NEBRASKA

Section 5
First Revised Sheet 10
Canceling Original Sheet 10

Information previously found in this section has been moved to Section 5 of the General Exchange Price List.

(D)

RECEIVED
MAY 12 1993
ACCT. & ENCL. DEPARTMENT
Nebr. Public Service Commission

(D)

ISSUED: May 12, 1993

EFFECTIVE: May 22, 1993

BY: J. L. Roe
Vice President Administration
5454 West 110th Street
Overland Park, Kansas 66211

GENERAL EXCHANGE TARIFF

UNITED TELEPHONE COMPANY
OF THE WEST
NEBRASKA

Section 5
First Revised Sheet 11
Canceling Original Sheet 11

Information previously found in this section has been moved to Section 5 of the General Exchange Price List.

(D)

RECEIVED

MAY 12 1993

ACCT. & ENCL. DEPT.
Nebr. Public Service Commission

(D)

ISSUED: May 12, 1993

EFFECTIVE: May 22, 1993

BY: J. L. Roe
Vice President Administration
5454 West 110th Street
Overland Park, Kansas 66211

GENERAL EXCHANGE TARIFF

UNITED TELEPHONE COMPANY
OF THE WEST
NEBRASKA

Section 5
First Revised Sheet 12
Canceling Original Sheet 12

Information previously found in this section has been moved to Section 5 of the General Exchange Price List.

(D)

RECEIVED

MAY 12 1993

ACCT. & ENGI. DEPARTMENT
Nebr. Public Service Commission

(D)

ISSUED: May 12, 1993

EFFECTIVE: May 22, 1993

BY: J. L. Roe
Vice President Administration
5454 West 110th Street
Overland Park, Kansas 66211

GENERAL EXCHANGE TARIFF

UNITED TELEPHONE COMPANY
OF THE WEST
NEBRASKA

Section 6
Seventh Revised Sheet 1
Canceling Sixth Revised Sheet 1

Reserved for Future Use

(T)

(M)

(M)

(M) Material on this page has been moved to the General Exchange Price List, Section 3.

ISSUED:
June 8, 2007

BY: Darlene Terry
Manager, Tariffs

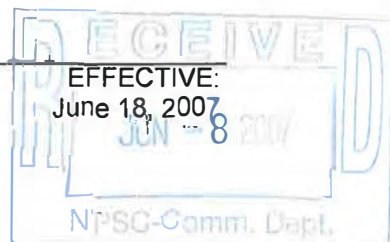

GENERAL EXCHANGE TARIFF

UNITED TELEPHONE COMPANY
OF THE WEST
NEBRASKA

Section 6
First Revised Sheet 2
Cancels Original Sheet 2

Reserved for Future Use

(T)

(M)

(M)

(M) Material on this page has been moved to the General Exchange Price List, Section 3.

ISSUED:
June 8, 2007

BY: Darlene Terry
Manager, Tariffs

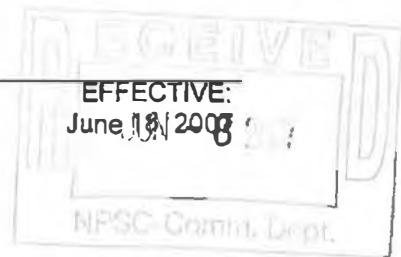

GENERAL EXCHANGE TARIFF

UNITED TELEPHONE COMPANY
OF THE WEST d/b/a CenturyLink
NEBRASKA

Section 7
Third Revised Sheet 1
Cancels Second Revised Sheet 1

INITIAL SERVICE PERIODS
AND
TERMINATION OF SERVICE

A. GENERAL

1. The initial service period for service and facilities is one month, except as otherwise specified hereinafter.
2. Initial service periods for service or facilities of any class will be greater than those specified herein whenever that is required in order for the Telephone Company to protect itself from making a hazardous investment because the subscriber's location or the character of the service required is such that upon termination of the subscriber's contract the facilities which have been constructed or installed to render the service are not likely to be useful for furnishing service to any other subscriber.
3. Service for which the initial service periods is one month may be terminated prior to the expiration of such period only by payment of charges for the entire initial period. The charges for any supplemental item of service or facilities furnished in connection with such service shall, however, be terminated in accordance with the regulations applicable to that item of service or facilities.
4. No charge is made for discontinuing any or all of the service or facilities furnished a subscriber, provided the initial service period for the service or facilities to be discontinued has expired and that any minimum charges for items of service or facilities have been paid in full.
5. When business service is terminated at the customer's request after the minimum service period or initial contract period has been met, service will be discontinued immediately, and a final bill will be issued in accordance with General Rules And Regulations Applying To Telephone Service, Prorating of Bills.

Residential customers may request termination of residence service at any time, and service will be discontinued on the last day of the customer's billing cycle after the minimum service period has been met. Final charges will be rendered in accordance with General Rules And Regulations Applying To Telephone Service, Prorating of Bills.

6. **Customer Denied Access**

(N)

The Company may either temporarily suspend service or terminate the service to any person, firm or corporation who fails to respond or who otherwise denies the Company access to the premises when such access is deemed necessary by the Company to maintain, transfer or otherwise modify service. The Company shall notify the customer at least 30 days prior to service suspension or termination. The Company shall waive any associated reconnection charges if such reconnection is made within 30 days, except that the Company does not guarantee the same phone number will be available if reconnection is requested.

(N)

ISSUED:
April 22, 2022

EFFECTIVE
May 3, 2022

NE2022-10

Received by NPSC
04/22/2022

GENERAL EXCHANGE TARIFF

UNITED TELEPHONE COMPANY
OF THE WEST
NEBRASKA

Section 7
Third Revised Sheet 2
Cancels Second Revised Sheet 2

INITIAL SERVICE PERIODS
AND
TERMINATION OF SERVICE

(D)

(D)

(T)

B. EXCHANGE SERVICE

1. Except as provided under "General", above, and in any Local or supplemental Local Exchange Tariffs, the initial service period for exchange service is one month.
2. Exchange Service may be terminated prior to the expiration of the initial service period applicable thereto, subject to termination charges computed as provided under "General", above or in any Local or supplemental Local Exchange Tariff.
3. The service of a subscriber who moves from one address to another in the same exchange area is ordinarily discontinued at the old address coincident with the establishment of service at the new address.
 - a. However, if the subscriber so requests and if conditions permit, the service at the old address will be continued; the subscriber is being charged a pro rata amount of the monthly rate applying for service at the old address for the days that service is furnished, which charges are in addition to the charges for service at the new address.

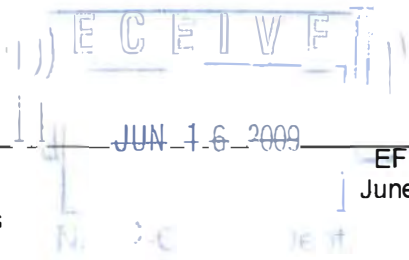

ISSUED:
June 16, 2009

BY: Darlene Terry ;
Manager, Tariffs

EFFECTIVE:
June 26, 2009

GENERAL EXCHANGE TARIFF

UNITED TELEPHONE COMPANY
OF THE WEST
NEBRASKA

Section 7
First Revised Sheet 3
Canceling Original Sheet 3

INITIAL SERVICE PERIODS
AND
TERMINATION OF SERVICE

(D)

(D)

ISSUED: July 15, 1986

BY: I. B. Watson
Vice President - Administration
6666 West 110th Street
Overland Park, Kansas 66211

EFFECTIVE: August 1, 1986
Docket No. C-574

GENERAL EXCHANGE TARIFF

UNITED TELEPHONE COMPANY
OF THE WEST
NEBRASKA

Section 8
Thirteenth Revised Sheet 1
Cancels Twelfth Revised Sheet 1

MILEAGE CHARGES

A. GENERAL

- 1. Where, for the purpose of furnishing any of the classes of circuits to which mileage or zone charges apply, as hereinafter specified, it is necessary to provide new construction, such construction will be provided under regulations governing "Construction Charges."

B. EXCHANGE ZONE CHARGES

- 1. The following monthly zone charges apply in connection with access lines or private branch exchange systems, including hotel message-rate private branch exchange systems, which are located outside of the base rate area, but within the exchange area:

<u>Zone</u>	<u>Monthly Charge</u>
Suburban (MAZAS1)	\$ 2.00
Zone 1 (MAZA1)	\$ 5.00
Zone 2 (MAZAB1)	\$ 9.00

C. EXTENSION AND TIE LINE MILEAGE

- 1. Extension and Tie Lines will be furnished at the rates shown below, provided the necessary facilities are available.
- 2. A tie line is a circuit between two private branch exchange systems, located within the same exchange area, which provides for direct communication between the stations of the two systems.
- 3. An extension line is an additional line facility connected to the same circuit as the main access line and having the same telephone number as the access line.
- 4. Off-premise extension lines or extension lines between different buildings on the same premise are furnished in connection with all classes of service, excluding **Payphone Line Service**.
- 5. Off-premise extension lines may not be installed at locations which do not have separate access line service.
- 6. For circuits requiring more than one pair conductors, each cable pair will be considered a circuit.

(T)
(T)

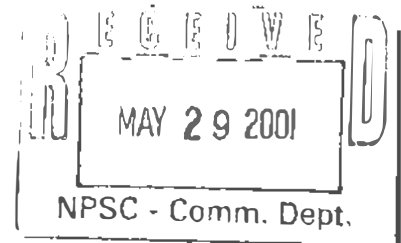

ISSUED:
May 29, 2001

BY: Warren D. Hannah
Director, Local Tariffs

EFFECTIVE:
June 8, 2001

GENERAL EXCHANGE TARIFF

UNITED TELEPHONE COMPANY
OF THE WEST d/b/a CenturyLink
NEBRASKA

Section 8
Ninth Revised Sheet 2 (C)
Cancels Eighth Revised Sheet 2

MILEAGE CHARGES

C. EXTENSION AND TIE LINE MILEAGE (Cont'd)

7. Mileage Rates for Local Loops Between Points Within the Same Exchange Area

	<u>Monthly Charge</u>	
a. Between points in the same building, different premises		
1) Extension Lines and Tie Lines, each (MAXCW)	\$2.75	
2) Service Connection Charges are applicable when service is initiated or when a move of facilities is requested.		
b. Between different buildings on the same premise; ⁽¹⁾		(C)
1) Extension Lines and Tie Lines (MAXCW) Per 1/4 mile or fraction thereof (Airline measurement)	\$2.75	
2) Service Connection Charges are applicable when service is initiated or when a move of facilities is requested.		

⁽¹⁾ Effective November 1, 2013, new installations of on-premises extensions will be provided as a one-time charge based on time and materials charges. Existing units of record as of November 1, 2013 will continue to be provided and maintained by the Company at the rates and charges listed above.

(N)
|
(N)

ISSUED:
October 22, 2013

BY: Darlene N. Terry
Manager, Tariffs

NE13-06

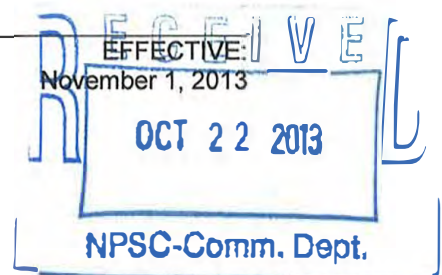

GENERAL EXCHANGE TARIFF

UNITED TELEPHONE COMPANY
OF THE WEST
NEBRASKA

Section 8
Sixth Revised Sheet 3
Cancels Fifth Revised Sheet 3

MILEAGE CHARGES

C. EXTENSION AND TIE LINE MILEAGE (Cont'd)

7. Mileage Rates for Local Loops Between Points Within the Same Exchange Area (Cont'd)

c. Between Points Not on the Same Premises

	<u>Monthly Charge</u>	
1) Off-Premise Extensions and Tie Lines for all voice grade services (MAPPG), (MBAAG), (MBAA), (MBBAG), (MBBAGG) per first 1/4 mile or fraction thereof (Airline Measurement)	\$4.15	(D)
2) Off-Premise Extensions and Tie Lines for all Voice Grade Services (MAPPL), (MBBAL), (MBBALG), (MBBAP), each additional 1/4 mile or fraction thereof (Airline Measurement)	\$2.75	(T) (D) (I)
3) Service Connection Charges as shown in Section 18 are applicable at the time service is initiated or when a move of facilities is requested.		(T)

NOTE: When the number of Extension and/or Tie Lines is such that cable facilities are required, such cable facilities may be provided for the customer's use and not as a part of the Telephone Company's general distributing plant at charges based upon cost in lieu of above charges where to do so will result in lower charges to the customer.

63-13-11

DEC 29 2008

Reg. Comm. Ex. pt.

ISSUED:
December 30, 2008

BY: Darlene N. Terry
Manager, Tariffs

EFFECTIVE:
January 9, 2009

GENERAL EXCHANGE TARIFF

UNITED TELEPHONE COMPANY
OF THE WEST
NEBRASKA

Second Revised Sheet 8
Canceling First Revised Sheet 8

GENERAL RULES AND REGULATIONS APPLYING TO TELEPHONE SERVICE (Cont'd)

TRANSMITTED RECORDED ANNOUNCEMENTS (Cont'd)

- c. Non-published telephone service will not be furnished for use with recorded public announcements.
- d. Failure to comply with the provisions of this Tariff shall be cause for termination of the service.

WAIVER OF INSTALLATION AND/OR SERVICE CONNECTION CHARGES - The Telephone Company may waive the service connection or installation charge for a limited period for new or existing services or products during special promotional periods to existing customers who wish to participate.

These special promotions will be offered on a non-discriminatory basis with each customer in the classification of service and area for which the promotion is offered having an equal opportunity for participation subject to the availability of services and facilities or products.

(N)
|
(N)

RECEIVED

MAR 21 1989

ACCOUNTS DEPARTMENT
Nebr. Public Service Commission

ISSUED: March 22, 1989

EFFECTIVE: April 1, 1989

BY: I. B. Watson
Vice President - Administration
5454 West 110th Street
Overland Park, Kansas 66211

LIFELINE ASSISTANCE PROGRAMS

A. FEDERAL LIFELINE PROGRAM

United Telephone Company of the West d/b/a CenturyLink concurs in Sections 5.2.6.A. of the Qwest Corporation d/b/a CenturyLink QC Exchange and Network Services Catalog, together with amendments and successive issues, for the purpose of administering the Federal Lifeline Program within its serving area.

(T)

B. NEBRASKA TELEPHONE ASSISTANCE PROGRAM (NTAP)

United Telephone Company of the West d/b/a CenturyLink concurs in Sections 5.2.6.B. of the Qwest Corporation d/b/a CenturyLink QC Exchange and Network Services Catalog, together with amendments and successive issues, for the purpose of administering the Nebraska Telephone Assistance Program (NTAP) within its serving area.

(T)

C. TRIBAL LANDS LIFELINE PROGRAM

The Company's serving area does not include areas defined as Tribal Lands.

(N)

(N)

D. LINK-UP PROGRAM

Link-Up assistance for non-Tribal Lifeline customers was eliminated as of April 1, 2012, pursuant to the FCC's Lifeline and Link Up Reform and Modernization, Report and Order and Further Notice of Proposed Rulemaking, WC Docket No. 11-42, FCC 12-11 (rel. Feb. 6, 2012).

(T)

(M)

(M)

(M) Material previously appeared in Section 18 on Eighth Revised Sheet 11.

ISSUED:
November 21, 2016
NE 16-07

BY: Darlene Terry
Manager - Tariffs

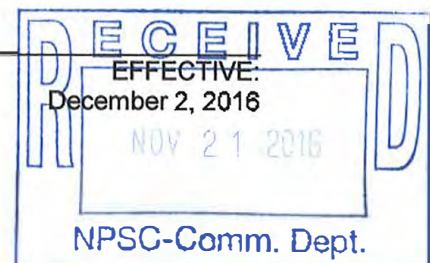

GENERAL EXCHANGE TARIFF

UNITED TELEPHONE COMPANY
OF THE WEST d/b/a CenturyLink
NEBRASKA

Section 9
Sixth Revised Sheet 2
Cancels Fifth Revised Sheet 2

LIFELINE ASSISTANCE PROGRAMS

(T)

THIS PAGE IS RESERVED FOR FUTURE USE

ISSUED:
November 21, 2016
NE 16-07

BY: Darlene Terry
Manager - Tariffs

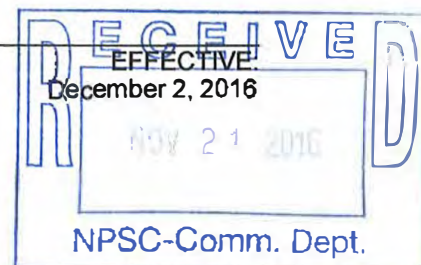

GENERAL EXCHANGE TARIFF

UNITED TELEPHONE COMPANY
OF THE WEST d/b/a CenturyLink
NEBRASKA

Section 9
Third Revised Sheet 3
Cancels Second Revised Sheet 3

LIFELINE ASSISTANCE PROGRAMS

(T)

THIS PAGE IS RESERVED FOR FUTURE USE

ISSUED:
November 21, 2016
NE 16-07

BY: Darlene Terry
Manager - Tariffs

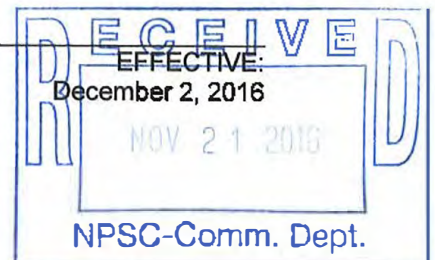

GENERAL EXCHANGE TARIFF

UNITED TELEPHONE COMPANY
OF THE WEST
NEBRASKA

Section 10
Seventh Revised Sheet 1
Cancels Sixth Revised Sheet 1

RESERVED FOR FUTURE USE

(T)

(D)

(D)

ISSUED:
June 16, 2009

BY: Darlene Terry
Manager, Tariffs

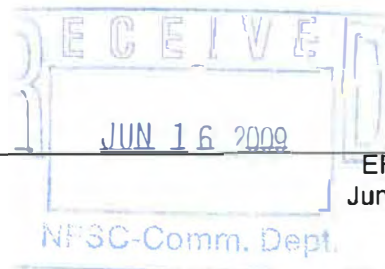

EFFECTIVE:
June 26, 2009

GENERAL EXCHANGE TARIFF

UNITED TELEPHONE COMPANY
OF THE WEST
NEBRASKA

Section 10
Second Revised Sheet 2
Cancels First Revised Sheet 2

RESERVED FOR FUTURE USE

(T)

(D)

(D)

(D)

(D)

ISSUED:
June 16, 2009

BY: Darlene Terry
Manager, Tariffs

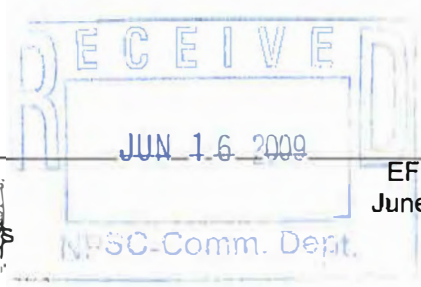

EFFECTIVE:
June 26, 2009

GENERAL EXCHANGE TARIFF

UNITED TELEPHONE COMPANY
OF THE WEST d/b/a CenturyLink
NEBRASKA

Section 11
Tenth Revised Sheet 1
Cancels Ninth Revised Sheet 1

RETURNED CHECK CHARGE

A Returned Check Charge (a.k.a. **Returned Payment Charge**) is applied to checks returned by the bank for insufficient funds, unable to locate account, account closed, balance held, drawn against uncollected funds, two signatures required, account garnisheed, endorsement incorrect, or payment stopped. A Returned Check Charge will not apply to checks returned by the bank when they are returned because of a Telephone Company error.

(T)

Service charge, per check returned **\$30.00**

(I)

This charge shall be in addition to any other charges found in this or any other section of this tariff.

ISSUED:
January 22, 2019

NE 19-01

BY: Darlene Terry
Manager, Tariffs

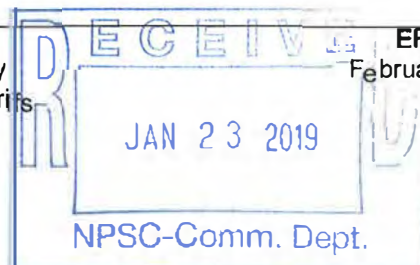

EFFECTIVE:
February 1, 2019

GENERAL EXCHANGE TARIFF

UNITED TELEPHONE COMPANY
OF THE WEST
NEBRASKA

Section 12
Fifth Revised Sheet 1
Canceling Fourth Revised Sheet 1

Information previously found in this section has been moved to Section 12 of the General Exchange Price List.

(D)

RECEIVED

DEC 21 1992

ACCT. & ENCL. DEPARTMENT
Nebr. Public Service Commission

(D)

ISSUED: December 21, 1992

EFFECTIVE: December 31, 1992

BY: John L. Roe
Vice President - Administration
5454 West 110th Street
Overland Park, Kansas 66211

GENERAL EXCHANGE TARIFF

UNITED TELEPHONE COMPANY
OF THE WEST
NEBRASKA

Section 12
Fifth Revised Sheet 2
Canceling Fourth Revised Sheet 2

Information previously found in this section has been moved to Section 12 of (D)
the General Exchange Price List.

RECEIVED (D)

DEC 21 1992

ACCT. & ENCL. DEPARTMENT
Nebr. Public Service Commission

ISSUED: December 21, 1992

EFFECTIVE: December 31, 1992

BY: John L. Roe
Vice President - Administration
5454 West 110th Street
Overland Park, Kansas 66211

GENERAL EXCHANGE TARIFF

UNITED TELEPHONE COMPANY
OF THE WEST
NEBRASKA

Section 12
Second Revised Sheet 3
Canceling First Revised Sheet 3

Information previously found in this section has been moved to Section 12 of (D)
the General Exchange Price List.

RECEIVED

DEC 21 1992

AGUT. & ENCL. DEPARTMENT
Nebr. Public Service Commission

(D)

ISSUED: December 21, 1992

EFFECTIVE: December 31, 1992

BY: John L. Roe
Vice President - Administration
5454 West 110th Street
Overland Park, Kansas 66211

GENERAL EXCHANGE TARIFF

UNITED TELEPHONE COMPANY
OF THE WEST d/b/a CenturyLink
NEBRASKA

Section 13
Sixth Revised Sheet 1
Cancels Fifth Revised Sheet 1

(T)

RESTORATION OF SERVICE

A. TEMPORARY SUSPENSION OF SERVICE

When the order providing for complete disconnection has not been completed, such service will be restored at the same location for a Restoration of Service Charge equal to the sum of one Service Order Charge per customer account plus one central office charge per access line plus one Trip Charge (when applicable) as specified in Section 18 of this General Exchange Tariff, in addition to all charges due up to the date of suspension.

Exceptions for **Lifeline subscribers** are set forth in Section 9 of this tariff.

(T)

B. COMPLETE DISCONNECTION

Subsequent to the completion of a disconnection order, service will be re-established only on the basis of a new application for service and the payment of the charges that would apply for the establishment of any new service for the subscriber. Such charges are in addition to any charges due for service and facilities furnished up to the date of suspension of service.

ISSUED:
November 21, 2016
NE 16-07

BY: Darlene Terry
Manager - Tariffs

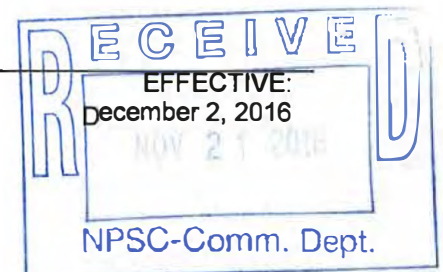

GENERAL EXCHANGE TARIFF

UNITED TELEPHONE COMPANY
OF THE WEST
NEBRASKA

Section 14
Fourth Revised Sheet 1
Canceling Third Revised Sheet 1

This sheet also cancels:

(D)

Third Revised Sheet 2
Third Revised Sheet 3
Second Revised Sheet 4
Fifth Revised Sheet 5
Fifth Revised Sheet 6
Third Revised Sheet 7
Second Revised Sheet 8
Third Revised Sheet 9
First Revised Sheet 10
First Revised Sheet 11

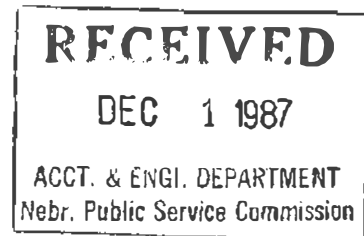

ISSUED:

BY: I. B. Watson
Vice President - Administration
6666 West 110th Street
Overland Park, Kansas 66211

EFFECTIVE:

GENERAL EXCHANGE TARIFF

UNITED TELEPHONE COMPANY
OF THE WEST
NEBRASKA

Section 15
Sixth Revised Sheet 1
Canceling Fifth Revised Sheet 1

PAYPHONE LINE SERVICE

(T)

(D)

(D)

ISSUED: January 15, 1997

EFFECTIVE: April 1, 1997

BY: John L. Roe
Vice President - Carrier & Regulatory Services
5454 West 110th Street
Overland Park, Kansas 66211

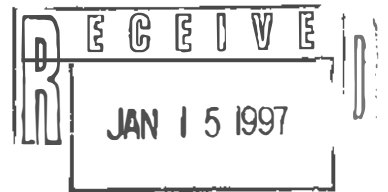

NPSC-Comm. Dept.

GENERAL EXCHANGE TARIFF

UNITED TELEPHONE COMPANY
OF THE WEST
NEBRASKA

Section 15
Ninth Revised Sheet 2
Canceling Eighth Revised Sheet 2

PAYPHONE LINE SERVICE

(T)

(D)

(D)

ISSUED: January 15, 1997

EFFECTIVE: April 1, 1997

BY: John L. Roe
Vice President - Carrier & Regulatory Services
5454 West 110th Street
Overland Park, Kansas 66211

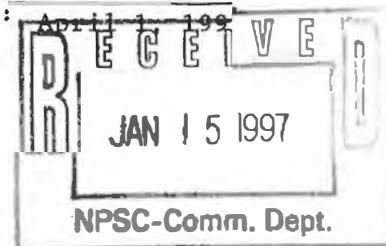

GENERAL EXCHANGE TARIFF

UNITED TELEPHONE COMPANY
OF THE WEST
NEBRASKA

Section 15
Second Revised Sheet 3
Canceling First Revised Sheet 3

PAYPHONE LINE SERVICE

(T)

(D)

(D)

ISSUED: January 15, 1997

EFFECTIVE: April 1, 1997

BY: John L. Roe
Vice President - Carrier & Regulatory Services
5454 West 110th Street
Overland Park, Kansas 66211

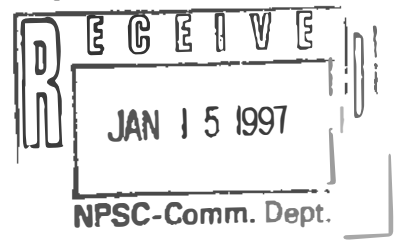

GENERAL EXCHANGE TARIFF

UNITED TELEPHONE COMPANY
OF THE WEST
NEBRASKA

Section 15
Fifth Revised Sheet 4
Canceling Fourth Revised Sheet 4

PAYPHONE LINE SERVICE

III. PAYPHONE SERVICE PROVIDER

A. GENERAL

1. Payphone Line Service is a class of service furnished to individuals, firms or corporations which permits connection of a customer-provided instrument that is activated by the deposit of coins, cards, tokens or the entry of a customer account number, to the lines of the Company.
2. Payphone Line Service is normally provided in those exchanges where the company offers Local Measured Service and Selective Class of Call Screening is available. Any customer who offers service through payphone service provider telephones where Selective Class of Call Screening is not available nonetheless assumes full and complete responsibility for all calls billed to the customer's line. Rates for payphone line service are found in section D. of this section, and the Local Exchange Tariff.
3. Selective Class of Call Screening Service enables a customer, by means of operator identification, to restrict outgoing toll calls from service point users to only those calls which are charged to the called telephone, a third number or a telephone company calling card account. All local calls, calls to the operator, calls to Telephone Company numbers such as repair service, Directory Assistance service, and public emergency service numbers, such as 911, will be permitted.
4. Toll restriction may be provided when the customer requires the denial of access to the DDD Network without going through the operator (1+ blocking).
5. Billed Number Screening, if provided, will control instances of fraud associated with billed to third party and station-to-station or person-to-person collect calls.
6. Directory listings may be provided under the regulations governing the furnishing of listings for business main line subscribers.
7. Payphone Service Provider telephones must be connected to **individual line** service and only one such instrument per line is allowed. (C)
8. Coin control service is available as an optional service for use in conjunction with payphone line service. Coin control service is based on a central office platform which offers features for use with coinless or coin operated (payphone) telephone service. Coin control service uses a software-driven system to provide features and capabilities similar to those provided by micro-processor based, "smart", payphone sets.

ISSUED:
June 16, 2009

BY: Darlene N. Terry
Manager - Tariffs

EFFECTIVE:
June 26, 2009

JUN 16 2009
NPSC-Comm. Dept

GENERAL EXCHANGE TARIFF

UNITED TELEPHONE COMPANY
OF THE WEST
NEBRASKA

Section 15
Original Sheet 4.1

PAYPHONE LINE SERVICE

III. PAYPHONE SERVICE PROVIDER

A. GENERAL (Cont'd)

- 9. Answer Supervision provides the capability of delivering "off-hook" supervisory signals from the subscriber's serving central office to a line interface at the customer premises for local and 1+ intraLATA toll calls processed and completed by the Telephone Company. These supervisory signals indicate that the called party has answered the incoming call (gone "off-hook").
 - a. Answer Supervision is furnished only from central offices arranged to provide this service and is provided subject to the availability of facilities.
 - b. This feature is only available with line side terminated PBX trunks and pay telephone access lines. It is not available with residence or business lines, digital facilities, or trunk side terminated facilities, such as DID trunks, or trunk side access facilities.

(N)

(N)

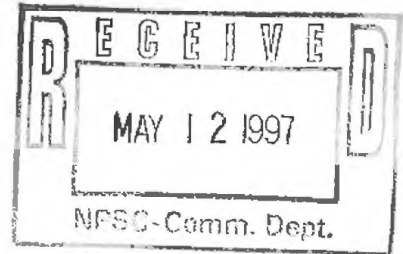

ISSUED:
May 9, 1997

BY: John L. Roe
Vice President - Carrier & Regulatory Services
5454 West 110th Street
Overland Park, Kansas 66211

EFFECTIVE:
May 19, 1997

GENERAL EXCHANGE TARIFF

UNITED TELEPHONE COMPANY
OF THE WEST
NEBRASKA

Section 15
Fourth Revised Sheet 5
Canceling Third Revised Sheet 5

PAYPHONE LINE SERVICE

III. PAYPHONE SERVICE PROVIDER

B. RESPONSIBILITY OF THE CUSTOMER*

1. The customer shall be responsible for the installation, operation and maintenance of any payphone service provider telephone used in connection with this service.
2. The customer shall be responsible for the payment of a Maintenance of Service Charge as provided in Section 11 *of the General Exchange Price List*, for visits by a Telephone Company employee to the customer's premises when a service difficulty or trouble report results from the use of customer-provided coin-operated telephones. (T)
3. The customer shall be responsible for payment of charges for all toll messages originating from or accepted at this type of service.
4. Payphone service provider telephones must be registered in compliance with Part 68 of the FCC's Registration Program or be connected behind an FCC registered coupler.
5. Payphone service provider telephones must have the following operational characteristics:
 - (a) Must be able to access the Telephone Company operator at no charge and without using a coin.
 - (b) Must be able to access 911 Emergency Service, where available, at no charge, without using a coin, and, when such instrument can only access 911 Emergency Service by use of a dialing sequence other than 911, must prominently display on such instrument, the appropriate dialing sequence to access 911 Emergency Service, where applicable.
 - (c) Must be able to access all interexchange carriers unless the customer is an interexchange carrier, in which case access may be limited to that carrier.

* For purposes of this tariff, the term "customer" is defined as the party who obtains service from the local operating telephone company.

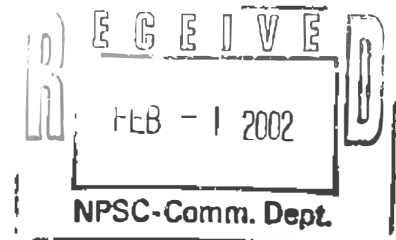

ISSUED:
February 1, 2002

BY: Warren D. Hannah
Director, Local Tariffs

EFFECTIVE:
February 14, 2002

GENERAL EXCHANGE TARIFF

UNITED TELEPHONE COMPANY
OF THE WEST
NEBRASKA

Section 15
Fourth Revised Sheet 6
Canceling Third Revised Sheet 6

PAYPHONE LINE SERVICE

III. PAYPHONE SERVICE PROVIDER (Cont'd)

B. RESPONSIBILITY OF THE CUSTOMER (Cont'd)

5. **Payphone service provider telephones must have ...** (Cont'd) (T)
- (d) Must comply with all applicable federal, state and local laws and regulations concerning the use of these telephones by disabled persons and the hearing impaired.
 - (e) Must allow the completion of both local and long distance calls from the zero (0) level.
6. The customer shall cause to be prominently displayed on each payphone service provider telephone used in connection with this service the name of the owner of such instrument, the procedure for reporting service difficulties and obtaining customer refunds, and the percentage or range of percentages by which the cost to the customer of long distance service to the vendor is increased to the user of such equipment.
7. The payphone service provider shall not charge the user more than twenty-five cents (25¢) per local telephone call.
8. Customers who elect not to subscribe to Billed Number Screening, as described in Section 11 of the **General Exchange Price List**, will be fully responsible for all collect calls and third number billed calls which are billed to customer's payphone access line. The Telephone Company shall have no responsibility to adjust any such charges and/or release customer from paying such charges. Customer will hold the Telephone Company harmless from and against any liability or loss resulting from all such collect calls and third number billed calls. (T)
9. Customers who elect not to subscribe to Selective Class of Call Screening, as described in **III.A.3 preceding**, will be fully responsible for all calls billed to customer's payphone access line. The Telephone Company shall have no responsibility to adjust any such charges and/or release customer from paying any such charges. Customer will hold the Telephone Company harmless from and against any liability or loss resulting from all calls billed to customer's exchange access line. (T)

APR 1

ISSUED:
April 21, 2009

BY: Darlene N. Terry
Manager - Tariffs

EFFECTIVE:
May 1, 2009

GENERAL EXCHANGE TARIFF

UNITED TELEPHONE COMPANY
OF THE WEST
NEBRASKA

Section 15
First Revised Sheet 6.1
Cancels Original Sheet 6.1

PAYPHONE LINE SERVICE

III. PAYPHONE SERVICE PROVIDER

C. VIOLATION OF REGULATIONS

1. Where any payphone service provider telephone is in violation of this tariff, the Telephone Company will promptly notify the customer of the violation and will take immediate action, including the disconnection of service, as is necessary for the protection of the telecommunications network and Telephone Company employees.
2. The customer shall discontinue use of the payphone service provider telephone or correct the violation and notify the Telephone Company in writing within 5 days after receipt of such notice that the violation has been corrected.
3. Failure of the customer to discontinue such use or to correct the violation will result in the suspension of the **customer's** service until such time as the customer complies with the provisions of this tariff.

(T)

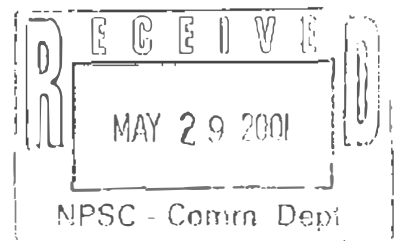

ISSUED:
May 29, 2001

BY: Warren D. Hannah
Director, Local Tariffs

EFFECTIVE:
June 8, 2001

GENERAL EXCHANGE TARIFF

UNITED TELEPHONE COMPANY
OF THE WEST
NEBRASKA

Section 15
Third Revised Sheet 7
Canceling Second Revised Sheet 7

PAYPHONE LINE SERVICE

III. PAYPHONE SERVICE PROVIDER

D. Rates

- 1. Service Connection Charges, as specified in Section 18 of this tariff, apply in addition to other charges specified for Payphone Line Service in the Local Exchange Tariff.
- 2. A "local message" from payphone service provider telephone service served by a given exchange is a completed local call, originating at such service and terminating at any service which may be called, without toll charge.
- 3. Payphone service provider telephone customers may assess applicable Directory Assistance charges to users of their coin or non-coin operated telephones.
- 4. Selective Class of Call Screening Charge - applicable when the customer requires screening to prohibit the charging of calls to the payphone line service access line (optional).....\$3.00
- 5. Toll Restriction Charge - applies when the blocking of 1+ (toll access) is required (optional).....\$3.00
- 6. Coin Control, each line (in addition to the payphone line)....\$4.00
- 7. In addition to the payphone access line rate, found in the Local Exchange Tariff, the subscriber will be responsible for paying the multi-line subscriber line charge.
- 8. All other applicable charges (e.g., toll charges, mileage charges, etc.) are the responsibility of the payphone line service subscriber.
- 9. Answer Supervision, each line (in addition to pay telephone service)..... \$4.00 (N)

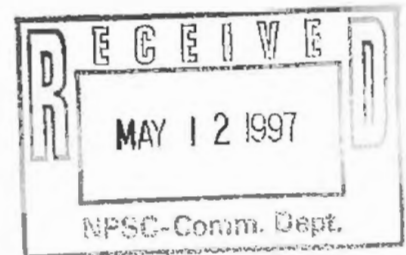

ISSUED:
May 9, 1997

BY: John L. Roe
Vice President - Carrier & Regulatory Services
5454 West 110th Street
Overland Park, Kansas 66211

EFFECTIVE:
May 19, 1997

GENERAL EXCHANGE TARIFF

UNITED TELEPHONE COMPANY
OF THE WEST
NEBRASKA

Section 16
Third Revised Sheet 1
Cancels Second Revised Sheet 1

BRIDGED MAIN STATION SERVICE

BRIDGED MAIN STATION SERVICE

A. GENERAL

1. To the extent that facilities and equipment for the purpose are available, two flat rate individual line main stations with identical out-going service privileges may be combined, i.e., permanently bridged, in a manner permitting answering of calls for either at the other station. Where so combined, the station bell at each main station will ring when either of the stations is called, except where it is practicable to associate an extension bell or other auxiliary signal with and on the same premises as such a main station, to indicate incoming calls directed to the other. Such auxiliary signals, where furnished, are subject to tariff rates.
2. If two main stations thus combined are located and served by the same central office, the flat rate for individual line business service applies to each business main station and the flat rate for individual line residence service applies to each residence main station.
3. Combined main station service is ordinarily provided only when both main stations are contracted for by the same subscriber, or when one subscriber is in business with, or is an employee or agent of, the other subscriber concerned.
4. Combined main station service that utilizes only one direct two wire circuit from the serving central office to the subscriber premises located within the serving central office **area may be provided at the flat rate business individual line and flat rate residence individual line rate.**

(C)
(C)

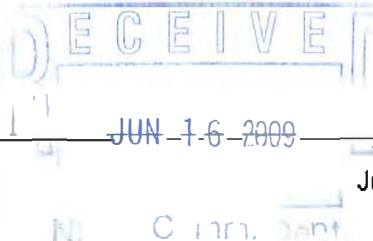

ISSUED:
June 16, 2009

BY: Darlene Terry
Manager, Tariffs

EFFECTIVE:
June 26, 2009

GENERAL EXCHANGE TARIFF

UNITED TELEPHONE COMPANY
OF THE WEST
NEBRASKA

Section 16
First Revised Sheet 2
Canceling Original Sheet 2

RESERVED FOR FUTURE USE

ISSUED: **SEP 18 1984**

BY: I. B. Watson
Vice President - Administration
6666 West 110th Street
Overland Park, Kansas 66211

EFFECTIVE: **NOV 07 1984**

GENERAL EXCHANGE TARIFF

UNITED TELEPHONE COMPANY
OF THE WEST
NEBRASKA

Section 17
Second Revised Sheet 1
Canceling First Revised Sheet 1

This sheet also cancels:

(D)

Third Revised Sheet 2
Second Revised Sheet 3
Fourth Revised Sheet 4
Fifth Revised Sheet 5

RECEIVED

DEC 1 1987

ACCT. & ENGI. DEPARTMENT
Nebr. Public Service Commission

ISSUED:

BY: I. B. Watson
Vice President - Administration
6666 West 110th Street
Overland Park, Kansas 66211

EFFECTIVE:

GENERAL EXCHANGE TARIFF

UNITED TELEPHONE COMPANY
OF THE WEST d/b/a CenturyLink
NEBRASKA

Section 18
Fifth Revised Sheet 1
Cancels Fourth Revised Sheet 1

SERVICE CONNECTION CHARGES

A. GENERAL

- 1 Service Connection Charges to connect, move, or change telephone service and equipment apply separately for one or more of the following work functions for complex business* or simple business/ residence** class of service customers:
 - a. Record Order Charge--For receiving, recording, and processing action necessary to execute a customer request where only customer, or company records are involved and no premise work, access line, or central office work is necessary. A record order charge does not apply for a change in billing address or address correction or for orders issued to record attachments of customer owned equipment. The record order charge is a stand-alone charge and does not apply when other service connection charges are applicable.
 - b. Service Order--Charge for the work associated with receive processing information necessary to execute a customer request to connect, move, or change telephone service and equipment.
 - c. Central Office Work--Charge for the work associated with establishment or changing the line connection in the Central Office wiring.
 - d. Line Work--Charge for the work associated changing the line connection in outside including the drop wire, protector equipment interface device (NID).
 - e. Trip or Visit--Charge for expense associated with traveling to a customer's premises,
 - f. On-Premise Labor/Material Charges - Charge, quoted in 15-minute increments for labor, and all materials associated with performing work on the customer's side of the protector or interface device including installations, additions, inside moves, changes and rearrangements.

* Complex business service customer – a customer with one or more of the following: more than two access lines, data, foreign exchange or private line service.

(D)

** Simple business/residence service customer – a customer with one or two access lines not terminating in common equipment.

NOV 2018

ISSUED:
November 30, 2018

BY: Darlene Terry
Manager, Tariffs

EFFECTIVE:
December 10, 2018

GENERAL EXCHANGE TARIFF

UNITED TELEPHONE COMPANY OF THE WEST
d/b/a CENTURYLINK
NEBRASKA

Section 18
Eighth Revised Sheet 2
Canceling Seventh Revised Sheet 2

SERVICE CONNECTION CHARGES

A. GENERAL (Cont'd)

1. (Cont'd)

- g. Network Interface Device (NID) Installation - Charge for the material and labor associated with the installation of a NID upon customer request. This charge would not apply if the customer is being charged an access line charge on the same order. This charge only applies to one and two line business or residence customers.
- h. Network Terminating Wire Charge - Wire associated with a network service, which is installed upon customer request between the predetermined demarcation point and the customer's chosen demarcation point and which is used to connect the access line to the network interface.
- i. **Service Date Change Charge – Applicable when customer requests a change of service date on a pending order for a Private Line Service or Design Service prior to the scheduled service date.**
- j. **Cancellation of Order Charge – Applicable when customer or the Company cancels an order for installation of a Private Line or Design Service for which the Company has already begun installation or incurred preparatory costs.**
- k. **Expedited Order Charge – Applicable when a customer requests a service date for a Private Line Service or Design Service that is earlier than the standard interval date for the service ordered.**

(N)

(N)

(M)

(M)

(M) Certain material previously appearing on this sheet now appears on Sheet 2A.

ISSUED:
July 21, 2017

BY: Darlene N. Terry
Manager, Tariffs

EFFECTIVE:
August 1, 2017

JUL 20 2017
NPSC-Comm. Dept.

GENERAL EXCHANGE TARIFF

UNITED TELEPHONE COMPANY
OF THE WEST d/b/a CenturyLink
NEBRASKA

Section 18
Third Revised Sheet 2A
Cancels Second Revised Sheet 2A

SERVICE CONNECTION CHARGES

A. GENERAL (Cont'd)

2. Service Connection Charges are in addition to any other scheduled tariff rates and charges. They apply in addition to and not in lieu of installation charges, nonrecurring charges (NRC), or construction charges which are found in other sections of this tariff.
3. The Charges specified herein do not contemplate work being performed at a time when overtime or premium wages apply due to the request of the customer; nor do they contemplate work once begun being interrupted by the customer. If the customer requests overtime labor performed or interrupts work once begun, a charge in addition to the specified charges will be made equal to the additional labor cost involved.
4. "Cost," as used in this section, is to be interpreted to mean the cost of labor and materials, including charges for supervision and other overhead expenses.
5. Service Connection Charges are applicable for the following:
 - a. Installations - Initial establishment of telephone service. No distinction is made between an installation and the "To" portion of a "To and From" service request.
6. Certain interexchange service connection charges covered by connecting company tariffs apply to installations, moves, and changes or interexchange services, such as foreign exchange lines, and other special services, and are in addition to charges in this tariff. (D)

Received

NOV 30 2018

NPSC Comm. Dept.

ISSUED:
November 30, 2018

BY: Darlene Terry
Manager, Tariffs

EFFECTIVE:
December 10, 2018

GENERAL EXCHANGE TARIFF

UNITED TELEPHONE COMPANY
OF THE WEST
NEBRASKA

Section 18
Eleventh Revised Sheet 3
Canceling Tenth Revised Sheet 3

SERVICE CONNECTION CHARGES

B. RATES

		<u>COMPLEX BUSINESS</u>	<u>SIMPLE BUSINESS/ RESIDENCE</u>	
a.	Record Order Charge	\$ 9.05	\$10.00	(1)
b.	Service Ordering Charge	21.40	20.00	
c.	Central Office Work Charge	10.00	10.00	(1)
d.	Access Line Work Charge	36.25	36.25	
e.	Trip or Visit Charge	15.00	15.00	(1)
f.	On Premise Labor/Material Charge (Per 15 minute increment or fraction thereof and all materials associated with performing the work.)	25.00	25.00	(1)
g.	Network Interface Device Charge	30.35	18.80	
h.	Network Terminating Wire Charge (Per 15 minute or fraction thereof.)	13.10	—	

NOTES:

1. The Service Connection Charge for a customer requested number change is equal to one Service Order Charge and one Central Office Charge.
2. The regrade Service Connection Charge is equal to one Service Order Charge, one Central Office Charge, and if applicable, one Access Line Work Charge. Regrade Service Connection Charges do not apply for regrades to the grade of service originally requested by the customer where a lower grade of service was initially installed due to shortage of company facilities.

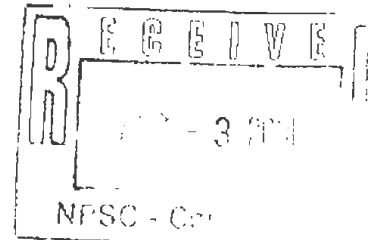

ISSUED:
April 3, 2001

BY: Warren D. Hannah
Director, Local Tariffs

EFFECTIVE:
May 1, 2001

GENERAL EXCHANGE TARIFF

UNITED TELEPHONE COMPANY OF THE WEST
d/b/a CENTURYLINK
NEBRASKA

Section 18
Fifth Revised Sheet 4
Cancels Fourth Revised Sheet 4

SERVICE CONNECTION CHARGES

C. APPLICATION OF RATES

1. Record Order Charge

a. The Record Order Charge is applicable, but not limited to, the following customer requests which do not involve line connection or on-premise work:

- 1) Changes or additions involving directory listings.
- 2) Service changes from one customer to another customer when there is no change in telephone number and no access line or on-premise work performed.

2. Service Order Charge

a. One Service Order Charge per order is applicable for work done to comply with a customer's request for installations, "To" orders, inside moves, rearrangements, regrades, number changes, and changes in telephone service and equipment. This also includes customer requested telephone number changes.

b. The term "per order" means all work or service ordered at the same time by the customer, which is performed or provided on the same premises (as defined in General Explanation of Terms).

c. One Service Order Charge is applicable to each service order which has off-premise mileage or channel charges between two or more points so long as all of the circuits are part of the same service order.

d. Unless otherwise specified, the appropriate Service Order Charge is applicable to a customer order for equipment or service, and is in addition to any other nonrecurring charge which may be applicable to that equipment or service provided.

3. Central Office Work Charge

a. One Central Office Work Charge is applicable for the work associated with establishing or changing the line connection in the central office wiring.

b. A Central Office Work Charge is applicable for each change in telephone number made at the customer's request.

(M)
(M)

(M) Material previously appeared on Seventh Revised Sheet 5.

ISSUED:
July 21, 2017

BY: Darlene N. Terry
Manager, Tariffs

EFFECTIVE:
August 1, 2017

17-03

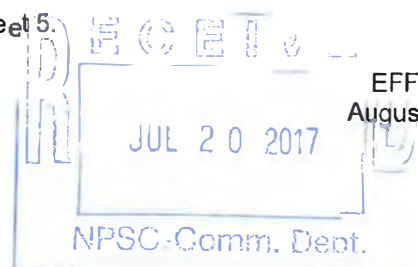

GENERAL EXCHANGE TARIFF

UNITED TELEPHONE COMPANY OF THE WEST
d/b/a CENTURYLINK
NEBRASKA

Section 18
Seventh Revised Sheet 5
Canceling Sixth Revised Sheet 5

SERVICE CONNECTION CHARGES

C. APPLICATION OF RATES (Cont'd)

(D)

(M1)
(M1)

4. Access Line Work

- a. One Access Line Work Charge is applicable for the work associated with establishing or changing the line connection in outside plant facilities, including the drop wire and protector.

5. Premise Trip or Visit Charge

- a. One Trip or Visit Charge is applicable for each customer initiated trip.

6. On Premise Labor/Material Charge

- a. The On-Premise Labor Charge is applicable to all work performed on the customer's side of the protector or interface device. This includes, but is not limited to:

- 1) Labor and material associated with installations, additions, inside moves, changes and rearrangements.

7. Network Interface Device (NID) Charge

(M2)

- a. The Network Interface Device Charge applies for each one or two line customer who requests the installation of a NID when service is already available at the location. A NID is required anytime a customer rewires or makes additions to existing customer premise inside wire. The charge would not apply if a new drop is being installed and the customer is being charged an access line charge.

8. Network Terminating Wire Charge

- a. Labor incurred to extend the demarcation point beyond the predetermined location to the customer requested location. The first 15 minutes of labor are provided without charge, after which the rate is applied in 15 minute increments. This charge applies only to complex multi-line systems.

(M2)

(M1) Certain material previously appearing on this sheet now appears on Sheet 4.

(M2) Material previously appeared on Original Sheet 5A.

ISSUED:
July 21, 2017

BY Darlene N Terry
Manager, Tariffs

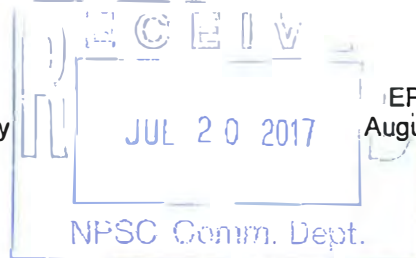

EFFECTIVE:
August 1, 2017

GENERAL EXCHANGE TARIFF

UNITED TELEPHONE COMPANY OF THE WEST
d/b/a CENTURYLINK
NEBRASKA

Section 18
First Revised Sheet 5A
Cancels Original Sheet 5A

SERVICE CONNECTION CHARGES

C. APPLICATION OF RATES (Cont'd)

9. Service Date Change Charge

The customer may request a change of service date on a pending Private Line Service or Design Service order prior to the service date. A change of service date is a change of the scheduled service date by the customer to either an earlier date or a later date which does not exceed 60 calendar days from the original service.

If the Company determines that the customer's request can be accommodated without delaying the service dates for orders of other customers, the service date will be changed and appropriate service charges will apply.

If the service date is changed to an earlier date, the customer will be notified by the Company that Expedited Order Charges may apply as set forth in 18.C.11 following. Such charges will apply in addition to service charges that apply for a change order.

If the requested service date exceeds 60 calendar days following the original service date, and the Company determines that the customer's request can be accommodated, the Company will cancel the original order and apply Cancellation Charges set forth in 18.C.10 following, and a new order with a new service date will be issued. In this instance, no service charge will apply for the service date change; however, normally applicable service ordering charges will apply to the new order. Failure by the Customer to notify the Company prior to the latest agreed upon service date to request a different service date may result in the application of a Trip/Visit Charge.

If a customer is unable to accept service within 30 days after the latest agreed upon service date, the order will either be cancelled or billing will commence as specified in Section 18.C.10.a.

(M1)

(M1)

(N)

(N)

(M2)

(M2)

(M1) Certain material previously appearing on this sheet now appears on Sheet 5.

(M2) Certain material previously appearing on this sheet now appears on Sheet 6.

ISSUED:
July 21, 2017

BY: Darlene N. Terry
Manager, Tariffs



EFFECTIVE:
August 1, 2017

GENERAL EXCHANGE TARIFF

UNITED TELEPHONE COMPANY OF THE WEST
d/b/a CENTURYLINK
NEBRASKA

Section 18
First Revised Sheet 5B
Cancels Original Sheet 5B

SERVICE CONNECTION CHARGES

C. APPLICATION OF RATES (Cont'd)

10. Cancellation of Order Charge (Cancellation Of Application For Service)

a. A customer may cancel an order for the installation of a Private Line Service or Design Service at any time prior to notification by the Company that service is available for the customer's use. The cancellation date is the date the Company receives written or verbal notice from the customer that the order is to be canceled. Verbal notice to the Company must be followed by written confirmation within 10 days. If a customer is unable to accept service within 30 calendar days of the latest agreed upon service date and the order has not been cancelled by the customer, the following will apply:

- The order will be cancelled and applicable cancellation charges will apply, if the service has not been fully provisioned, or
- The order will be completed and billing will commence once the service has been fully provisioned.

A service is fully provisioned when all physical CenturyLink work has been completed (i.e., design, installation, and testing), and service is immediately available for use upon customer acceptance or activation.

b. When a customer cancels an order for the installation of a Private Line Service or Design Service, a Cancellation Charge will apply as specified in the "Cancellation of Application for Service" paragraph of the "General Rules and Regulations Applying to Telephone Service" section of this tariff.

11. Expedited Order Charge

An Expedited Order Charge applies when a customer requests a service date for a Private Line Service or Design Service that is earlier than the standard interval. If the Company agrees to provide the service on an expedited basis, an expedited order charge may apply as specified in Section 3, Construction Charges **and Other Special Charges**, unless set forth elsewhere in this tariff for a specific service.

(T)
(T)

ISSUED:
May 22, 2020

BY: Darlene Terry
Manager, Tariffs

EFFECTIVE:
June 1, 2020

NF 2020-04

Received by NPSC
05/22/2020

GENERAL EXCHANGE TARIFF

UNITED TELEPHONE COMPANY OF THE WEST
d/b/a CENTURYLINK
NEBRASKA

Section 18
Seventh Revised Sheet 6
Cancels Sixth Revised Sheet 6

SERVICE CONNECTION CHARGES

D. SERVICE CONNECTION CHARGES FOR OFF-PREMISE MOVES

1. Where telephone service is moved from one to another premise in the same exchange:
 - a. Any service at the old location which is terminated rather than moved is subject to any minimum or termination charges which apply.
 - b. Any service moved to or established at the new location is subject to any service connection charges, installation charges, minimum and basic termination charges, and to the initial service period, which would apply to a complete new installation of like size and character at the new location.

(M)
|
(M)

E. SERVICE CONNECTION CHARGES DO NOT APPLY TO:

1. Telephone Company provided equipment located on a customer's premises but used exclusively by the Telephone Company for maintenance or training activities.
2. Service reestablished after destruction of the customer's premises by an act of God or a public enemy, whether at the same or another location. Regular service connection charges apply, however, to service reestablished in the old location after termination of service or subsequent to its establishment at another location under the above circumstances.
3. Disconnection and/or removal of the following items of service or Telephone Company provided equipment providing no other work subject to service connection charges is involved:
 - a. Directory listings and directory services for which monthly recurring charges apply except that service connection charges will apply to customers who have published numbers and go to nonlisted or nonpublished numbers, or those who change nonlisted or nonpublished numbers or go from nonlisted or nonpublished numbers to published numbers.
 - b. Other items of service or equipment for which a monthly recurring charge applies.
4. The "From" portion of work involved in a transfer of service from one to another premises.

(M) Material previously appeared on Original Sheet 5A.

ISSUED:
July 21, 2017

BY: Darlene N. Terry
Manager, Tariffs

EFFECTIVE:
August 1, 2017

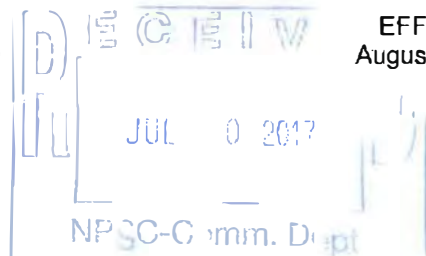

GENERAL EXCHANGE TARIFF

UNITED TELEPHONE COMPANY
OF THE WEST d/b/a CenturyLink
NEBRASKA

Section 18
Fourth Revised Sheet 7
Cancels Third Revised Sheet 7

SERVICE CONNECTION CHARGES

E. SERVICE CONNECTION CHARGES DO NOT APPLY TO: (Cont'd)

5. The following cases, if the contract for the service and responsibility for the account including any amounts due or past due, are taken over prior to discontinuance of service and without lapse in rendition of or charge for service:
 - a. A change in the ownership of a business if no service order is issued.
 - b. A transfer or residence service from one member of a family to another member of such family at the same location, not requiring a service order.
6. Changes from one grade of service to another, when the change is initiated by the telephone company, or when the telephone company was unable to provide the class or grade of service initially requested by the customer.
7. A change of name without change in the identity of a customer, as when a customer's name is changed by marriage or by authority of court order.
8. Government or telephone company directed customer address changes.
9. Establishing, changing, or discontinuing arrangements for Recurring Payments billing plan.
10. Company initiated temporary detachment and subsequent replacement of service.
11. The establishment or termination of a receivership, provided responsibility for service and facilities is assumed prior to discontinuance of service and without lapse in charge.
12. A customer's classification changes from Business to Residence or from Residence to Business. Normal service connection charges apply only if grade of service is changed.
13. Changes in billing name and address.
14. **For active duty members of the United States military and their dependents with valid military ID cards, all service connection charges typically applicable to central office reconnects will be waived when establishing local exchange access line service or transferring existing local exchange access line service from one location to another. Central office reconnects are defined as customer requests for service that do not require any physical work beyond the Company's central office.**

(N)
|
(N)

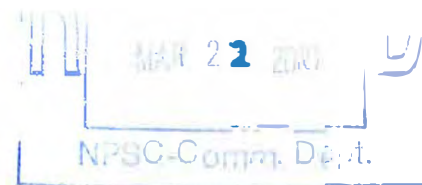

ISSUED:
March 22, 2010

BY: Darlene Terry
Manager, Tariffs

EFFECTIVE:
April 1, 2010

GENERAL EXCHANGE TARIFF

UNITED TELEPHONE COMPANY
OF THE WEST
NEBRASKA

Section 18
Third Revised Sheet 8
Cancels Second Revised Sheet 8

SERVICE CONNECTION CHARGES

RESERVED FOR FUTURE USE

(T)

(M)

(D)

(M) Material found on this sheet now appears on Third Revised Sheet 7.

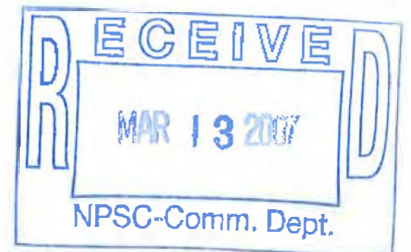

ISSUED:
March 13, 2007

BY: Darlene Terry
Manager, Tariffs

EFFECTIVE:
March 23, 2007

GENERAL EXCHANGE TARIFF

UNITED TELEPHONE COMPANY
OF THE WEST
NEBRASKA

Section 18
Second Revised Sheet 9
Canceling First Revised Sheet 9

SERVICE CONNECTION CHARGES

F. APPLICATION OF SERVICE CONNECTION CHARGES TO ENCOURAGE CUSTOMER PARTICIPATION

1. Inward Movement

a. Reconnect--Any reestablishment of service at a premise previously connected for service:

1) Access Line Work Charge is waived if drop is in place and connect-through status is in effect. On Premise Labor and Trip Charges may be waived if no trip is required. All other service connection elements would apply.

2. Miscellaneous Orders

a.

(D)

1)

(D)



ISSUED:

BY: I. B. Watson
Vice President - Administration
6666 West 110th Street
Overland Park, Kansas 66211

EFFECTIVE:

GENERAL EXCHANGE TARIFF

UNITED TELEPHONE COMPANY
OF THE WEST
NEBRASKA

Section 18
First Revised Sheet 10
Canceling Original Sheet 10

SERVICE CONNECTION CHARGES

F. APPLICATION OF SERVICE CONNECTION CHARGES TO ENCOURAGE CUSTOMER PARTICIPATION (Cont'd)

3. Service Connection Charges for Off-Premises Moves to Special Equipment

a. Where telephone service is moved from one to another premise in the same exchange.

1) Any service at the old location which is terminated rather than moved is subject to any minimum or termination charges which apply.

2) Any service moved to or established at the new location is subject to any service connection charges, installation charges, minimum and basic terminating charges, and to the initial service period, which would apply to a complete new installation of like size and character at the new location.

(D)

(D)

ISSUED: July 15, 1986

BY: I. B. Watson
Vice President - Administration
6666 West 110th Street
Overland Park, Kansas 66211

EFFECTIVE: August 1, 1986
Docket No. C-574

GENERAL EXCHANGE TARIFF

UNITED TELEPHONE COMPANY
OF THE WEST d/b/a CenturyLink
NEBRASKA

Section 18
Ninth Revised Sheet 11
Cancels Eighth Revised Sheet 11

SERVICE CONNECTION CHARGES

(M)

(M)

THIS PAGE IS RESERVED FOR FUTURE USE

(N)

(M) Material previously appearing on this sheet now appears on Sheet 1 of Section 9.

ISSUED:
November 21, 2016
NE 16-07

BY: Darlene Terry
Manager - Tariffs

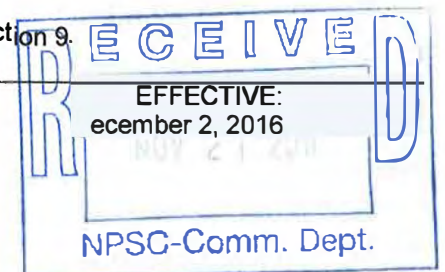

GENERAL EXCHANGE TARIFF

UNITED TELEPHONE COMPANY
OF THE WEST d/b/a CenturyLink
NEBRASKA

Section 18
Third Revised Sheet 12
Cancels Second Revised Sheet 12

(C)

SERVICE CONNECTION CHARGES

RESERVED FOR FUTURE USE

(C)

(D)

(D)



ISSUED:
April 2, 2012

BY: Darlene Terry
Manager - Tariffs

EFFECTIVE:
April 12, 2012

GENERAL EXCHANGE TARIFF

UNITED TELEPHONE COMPANY
OF THE WEST **d/b/a CenturyLink**
NEBRASKA

Section 18
Second Revised Sheet 13 (C)
Cancels First Revised Sheet 13

SERVICE CONNECTION CHARGES

RESERVED FOR FUTURE USE (Cont'd) (C)

(D)

(D)



ISSUED:
April 2, 2012

BY: Darlene Terry
Manager - Tariffs

EFFECTIVE:
April 12, 2012

GENERAL EXCHANGE TARIFF

UNITED TELEPHONE COMPANY
OF THE WEST
NEBRASKA

Section 19
Fifth Revised Sheet 1
Cancels Fourth Revised Sheet 1

N11 SERVICE

(T)

A. 911 Service

1. GENERAL

- a) Emergency Number Service, also referred to as 911 Service, is a telephone exchange communication service whereby a Public Safety Answering Point (PSAP), designated by the customer, receives and answers telephone calls placed by dialing number 911. Emergency Number Service also includes the service provided by the lines and equipment associated with the service arrangement for the answering, transferring, and dispatching of public emergency telephone calls dialed to 911.
- b) 911 Services are offered subject to availability of facilities.
- c) The customer for Emergency Number Service may be a municipality or other state or local governmental units, or an authorized agent of one or more municipalities or other state or local governmental units to whom authority has been lawfully delegated. The customer must be legally authorized to subscribe to the service and have public safety responsibility by law to respond to telephone calls from the public for emergency police, fire fighting or other emergency services within the telephone central office areas arranged for 911 calling.
- d) Four types of 911 Service are offered: B911, C911, D911, and E911.

2. RULES AND REGULATIONS

- a) This service is limited to the use of central office telephone number 911 as the universal telephone number and only one 911 service will be provided within any government agency's locality.
- b) Emergency Number Service will be provided to only one PSAP for calling from any telephone number within a central office serving area if the Selective Routing feature is furnished. If E911 Service is furnished to a customer with the Selective Routing feature for a part of a central office serving area, and a request is received from a governmental unit with police and fire public safety responsibility for other parts of the central office serving area, service will be offered under the terms and at the rates specified in this tariff.



GENERAL EXCHANGE TARIFF

UNITED TELEPHONE COMPANY
OF THE WEST
NEBRASKA

Section 19
Third Revised Sheet 2
Cancels Second Revised Sheet 2

N11 SERVICE

(T)

A. 911 Service (Cont'd)

2. RULES AND REGULATIONS (Cont'd)

- c) The 911 emergency telephone number is not intended to be a total replacement of the telephone service of the various public safety agencies which may participate in the use of this number and the public safety agencies will subscribe to other telephone service as provided in II.G.5. of this section.
- d) The service is furnished to the customer only for the purpose of receiving reports of emergencies by the public.
- e) 911 exchange lines are classified as Business Exchange Service and are arranged for one-way incoming service to the appropriate PSAP.
- f) Application for 911 Service must be executed in writing by each customer. If application for service is made by an agent, the Telephone company must be provided in writing with satisfactory proof of appointment of the agent by the customer.
- g) In addition to all other terms and conditions, the following applies:
 - 1. That all 911 calls will be answered on a 24-hour, seven-day -per-week basis.
 - 2. That the customer has the responsibility for dispatching public safety police, fire and ambulance emergency service within the 911 service area, or will undertake to transfer all 911 calls received to the governmental agency with responsibility for dispatching such public safety emergency services, to the extent that such services are reasonably available.
 - 3. That the customer will also develop an appropriate method for responding to calls for nonparticipating agencies which may be directed to the 911 PSAP by calling parties.
 - 4. That the customer will subscribe to a sufficient number of interoffice facilities and 911 exchange lines, as determined by the Telephone Company to adequately handle incoming calls. In all cases, a minimum of two facilities or lines are required at



ISSUED:
September 20, 2004

BY: Warren D. Hannah
Director, Tariffs

EFFECTIVE:
September 30, 2004

GENERAL EXCHANGE TARIFF

UNITED TELEPHONE COMPANY
OF THE WEST
NEBRASKA

Section 19
Third Revised Sheet 3
Cancels Second Revised Sheet 3

N11 SERVICE

(T)

A. 911 Service (Cont'd)

2. RULES AND REGULATIONS (Cont'd)

- g) In addition to all other terms and conditions, the following applies: (Cont'd)

any point in the 911 network including the 911 exchange lines terminating at the PSAP. For 911 exchange line groups from an E911 control office to a secondary answering location used for central office transfer purposes only, the line quantity may be determined by the customer and could result in only one line being provided.

5. That the customer will subscribe for additional local exchange service at the PSAP location for administrative purposes, for placing of outgoing calls and for receiving other emergency calls including any which may be relayed by Telephone Company operators.
6. That when the Selective Routing feature is furnished the customer subscribing to E911 Service will furnish designation of the primary and secondary PSAP for receipt of police, fire, and ambulance calls by street address as provided in II.R. of this section.
- h) Compatible Customer provided equipment may be used with 911 Service in accordance with the provisions of Section 23 of this tariff.
- i) Temporary suspension of service at the request of the customer, either partial or complete, is not applicable to any part of 911 Service.
- j) The Telephone Company's entire liability to any person for interruption or failure of any emergency numbers services shall be limited to the terms set forth in this section and other sections of this tariff.
- k) Because the Telephone Company serving boundaries and political subdivision boundaries may not coincide, the customer must make arrangements to handle all calls received on its 911 service lines that originate from all telephones served by central offices to be answered by the customer, whether or not the calling telephone is situated on property within the geographical boundaries of the customer's public safety jurisdiction.



GENERAL EXCHANGE TARIFF

UNITED TELEPHONE COMPANY
OF THE WEST
NEBRASKA

Section 19
Fifth Revised Sheet 4
Cancels Fourth Revised Sheet 4

N11 SERVICE

A. 911 Service (Cont'd)

2. RULES AND REGULATIONS (Cont'd)

- i) 911 Services are furnished subject to all operating failures and interruptions including, but not limited to, equipment breakdowns, errors, defects, malfunctions and interruptions of service experienced in the regular telephone exchange system. 911 Services are furnished subject to any additional forms of service failures and service degradations resulting from the complexity of the service arrangement, program errors and failures, delays and errors in the input and processing of data used by the Data Base Management System (DBMS) associated with the E911 Service arrangement. The rates provided for this service are subject to the limitations which appear in this section and in other applicable sections of this and other tariffs. The Telephone Company does not undertake to provide a higher level of service reliability and quality than the telephone exchange service being provided in the exchange that 911 is offered.
1. 911 Service is provided solely for the benefit of the municipal subscriber; and the provision of such service shall not be interpreted, construed or regarded as being for the benefit of, or creating any Telephone Company obligation toward or any right of action on behalf of, any third person or other legal entity.
 2. The Telephone Company does not undertake to answer and forward 911 calls, but furnishes the use of its facilities to enable the customer to respond to such calls with the customer's personnel on the customer's premises.
 3. The rates charged for 911 Service do not contemplate and the Telephone Company does not undertake inspection or constant monitoring to discover errors, defects and malfunctions in the service. The customer shall have the responsibility of discovering all errors, defects and malfunctions, and assumes the duty of, and will make such tests as, in the judgment of the customer, are required to determine whether the system is functioning properly for its use. The customer shall promptly notify the Telephone Company in the event the system is not functioning properly.
 4. The Telephone Company shall not be liable for any loss or damages arising out of errors, interruptions, defects, failures, or malfunctions of 911 Service, including any and all equipment and data processing systems associated therewith. **Damages arising out of such interruptions, defects, failures, or malfunctions of the system after the Telephone Company has been so notified and has had a reasonable time for repair shall in no event exceed an amount equivalent to the charges made for the service affected for the period following notice from the customer until service is restored.**

(M)
|
(M)

(M) Material now appearing on this page previously appeared on Fourth Revised Sheet 5.

ISSUED:
June 16, 2009

BY: Darlene Terry
Manager, Tariffs

EFFECTIVE:
June 26, 2009

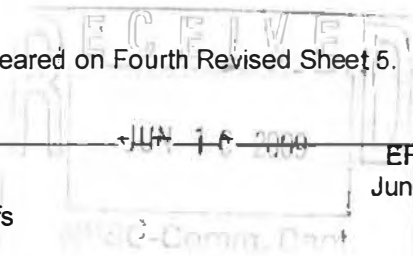

GENERAL EXCHANGE TARIFF

UNITED TELEPHONE COMPANY
OF THE WEST
NEBRASKA

Section 19
Fifth Revised Sheet 5
Cancels Fourth Revised Sheet 5

N11 SERVICE

A. 911 Service (Cont'd)

2. RULES AND REGULATIONS (Cont'd)

l) 911 Services are furnished ... (Cont'd)

(M)
|
(M)

m) E911 data information, respecting the name, address and telephone number of nonpublished telephone customers, is confidential and the customer agrees to use such information only for the purpose of responding to emergency calls.

n) The calling party dialing 911 forfeits the privacy afforded by nonpublished service to the extent that the calling party's number, address and name are furnished to the public safety answering point.

o) Central offices that are not currently equipped to transmit ANI will not be modified to provide ANI just for 911 Services. When the Selective Routing feature is provided, in such circumstances, Default Routing and central office identification will be provided in lieu of Selective Routing and/or ANI Display.

(D)
(D)

p) A minimum of two E911 Interoffice Facilities between the end office and the E911 Control Office and two E911 Exchange Lines to each primary PSAP must be provided. On B911, C911, and D911, a minimum of two 911 exchange lines to each PSAP is required.

(T)

q) When the Selective Routing feature is provided (E911), the customer is responsible for identifying the unique combinations of police, fire and ambulance, or any other appropriate agencies jurisdiction in the E911 serving area. An Emergency Service Number (ESN) will be provided for each unique combination by the Telephone Company. The customer will associate these ESNs with street address ranges in the E911 serving area. These ESNs will be carried in the Data Base Management System (DBMS) to route E911 calls to the primary and secondary **PSAPs with responsibility to handle the emergency telephone calls originating for each telephone in the E911 serving area.**

(T)

(M1)
|
(M1)

(M) Material previously appearing on this page now appears on Fifth Revised Sheet 4.

(M1) Material now appearing on this page previously appeared on Third Revised Sheet 6.

ISSUED:
June 16, 2009

BY: Darlene Terry
Manager, Tariffs

JUN 16 2009
N. C. nm. D. t.

EFFECTIVE:
June 26, 2009

GENERAL EXCHANGE TARIFF

UNITED TELEPHONE COMPANY
OF THE WEST
NEBRASKA

Section 19
Fourth Revised Sheet 6
Cancels Third Revised Sheet 6

N11 SERVICE

A. 911 Service (Cont'd)

2. RULES AND REGULATIONS (Cont'd)

q) When the Selective Routing feature is provided (E911) ... (Cont'd)

(T)

(M)

(M)

The customer's responsibility for providing this information is as follows:

1. The customer will provide street address and PSAP routing information for each central office area included in the E911 service area prior to establishment of service.
2. Initial and subsequent ESN assignments by street name, address range and area or other mutually agreed upon routing criteria, shall be furnished by the customer to the Telephone Company on forms supplied by the Telephone Company for that purpose at a mutually agreed upon time prior to the effective date of the service.
3. After establishment of service, it is the customer's responsibility to continue to verify the accuracy of the routing information contained in the master address file and to advise the Telephone Company of any changes that need to be made in the routing information by reason of changes in street names, establishment of new streets, changes in address numbers used on existing streets, closing and abandonment of streets, changes in police, fire, ambulance or other appropriate agencies' jurisdiction over any address, annexations and other changes in municipal and county boundaries, incorporation of new cities and any other matters that will affect the routing of E911 calls to the proper PSAP.
 - a) Changes, deletions and additions which the customer desires to have made in the master address file should be submitted on an "as occurred" basis.
 - b) The Telephone Company will furnish a written copy to the customer for verification showing each change, deletion and addition to master address file.
4. The Telephone Company will provide at the request of the customer, a complete written copy of the master address file for the purpose of the customer verifying the accuracy of the police, fire and ambulance PSAP routing designations.

(M) Material previously appearing on this page now appears on Fifth Revised Sheet 5.

ISSUED:
June 16, 2009

BY: Darlene Terry
Manager, Tariffs

UN 6 2009
EFFECTIVE:
June 26, 2009

GENERAL EXCHANGE TARIFF

UNITED TELEPHONE COMPANY
OF THE WEST
NEBRASKA

Section 19
Fourth Revised Sheet 7
Cancels Third Revised Sheet 7

N11 SERVICE

A. 911 Service (Cont'd)

2. RULES AND REGULATIONS (Cont'd)

- r) Cancellation of the service in whole or part by the customer prior to establishment thereof will require payment of an amount equal to the cost of engineering, manufacturers' billings resulting from equipment orders, installation, assembly, labor, cost of removal and any other costs incurred up to the time of cancellation resulting from the customer's order for service, but not to exceed the total nonrecurring charges. (T)
- s) Where not otherwise precluded by law, each customer agrees to release, indemnify, defend and hold harmless the Company from any and all loss, claims, demands, suits or other action, or any liability whatsoever, whether suffered, made, instituted or asserted by the customer or by any other party or person, for any personal injury to or death of any person or persons, or for any loss, damage or destruction of any property, whether owned by the customer or others. (T)
- t) Where not otherwise precluded by law, the customer also agrees to release, indemnify and hold harmless the Company for any infringement or invasion of the right of privacy of any person or persons caused or claimed to have been caused, directly or indirectly, by the installation, operation, failure to operate, maintenance, removal presence, condition, occasion or use of 911 Service features and the equipment associated therewith, or by any services furnished by the Company in connection therewith, including but not limited to, the identification of the telephone used by the party or parties accessing 911 Service hereunder, and which arise out of the negligence or other wrongful act of the Company, the customer, its user, agencies or municipalities, or the employees or agents of any one of them. (T)

3. EXPLANATION OF TERMS

Additional E911 Service Exchange Line:

An additional line terminating at a PSAP that may be ordered by the customer as an optional feature.

Alternate Routing (AR):

This feature is provided to allow 911 calls to be routed to a designated alternate location if (1) all E911 exchange lines to the primary PSAP are busy, or (2) the primary PSAP closes down for a period (night service).

ISSUED:
June 16, 2009

BY: Darlene Terry
Manager, Tariffs

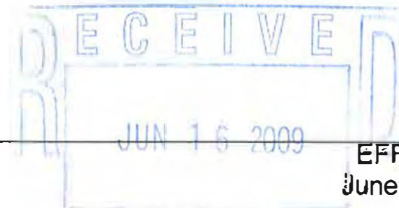

EFFECTIVE:
June 26, 2009

GENERAL EXCHANGE TARIFF

UNITED TELEPHONE COMPANY
OF THE WEST
NEBRASKA

Section 19
Third Revised Sheet 8
Cancels Second Revised Sheet 8

N11 SERVICE

(T)

A. 911 Service (Cont'd)

3. EXPLANATION OF TERMS (Cont'd)

Automatic Number Identification (ANI):

This forwards the calling party's telephone number to the E911 Control Office and on to the PSAP for display on the ANI Display and Transfer Unit. This is an optional feature of E911 Service.

B911:

A service that provides for routing all 911 calls originated from telephones with given central office prefix codes to a single PSAP.

Called Party Hold (CPH):

A feature of C911 Service that enables a PSAP attendant to retain control of an incoming 911 call connection, even if the calling party hangs up.

C911:

A service that provides the B911 feature as well as Called Party Hold, Switchhook Status, Forced Disconnect, Idle Tone Application and Emergency Ringback.

Data Management System (DMS):

The DMS is a system of procedures and computer programs used to create, store and update the data required to provide the Selective Routing (SR) feature.

Default Routing (DR):

This feature is activated when an incoming 911 call cannot be selectively routed due to an ANI failure, garbled digits or other causes which may prevent selective routing. Such incoming calls to the E911 Control Office are routed to a default PSAP. Each incoming 911 facility group to the Control Office is assigned to a designated default PSAP.

Display and Transfer Unit:

A selector console and associated common equipment that displays ANI numbers at the PSAP attendant position and is used by the attendant to activate Fixed and/or Selective Transfer functions.

D911:

A service which provides the B911 feature plus Automatic number Identification (ANI) and is primarily for use in single wire center exchanges.



GENERAL EXCHANGE TARIFF

UNITED TELEPHONE COMPANY
OF THE WEST
NEBRASKA

Section 19
Third Revised Sheet 9
Cancels Second Revised Sheet 9

N11 SERVICE

(T)

A. 911 Service (Cont'd)

3. EXPLANATION OF TERMS (Cont'd)

End Office:

This is the Central Office(s) in the 911 System from where the 911 calls originate.

E911:

An expanded service that provides features such as Selective Routing of 911 calls to a specific PSAP selected from among those within the 911 Service Area. E911 has other standard and optional features which may or may not be available with B911, C911 or D911.

Expanded 911 (E911) Control Office:

The Control Office provides tandem switching capability for E911 calls. It controls switching of ANI and SR information to the PSAP.

Fixed Transfer:

This feature enables a PSAP attendant to transfer incoming 911 calls to secondary PSAPs by use of a single button on the Display and Transfer Unit. The PSAP equipment automatically flashes and sends out the Speed Calling code associated with the desired agency. ANI will also be transferred with the call to a secondary PSAP that is equipped to receive and display ANI data. This is done by using the Central Office Call Transfer feature of the E911 Control Office. This feature is associated with the E911 trunk unit and may not be available from all central offices. This is an optional feature of E911 Service.

Forced Disconnect:

This feature, a function of the E911 Central Office trunk circuit enables the PSAP attendant to release a 911 connection even though the 911 calling party has not hung up. This feature prevents the jamming of the E911 exchange lines. This is a standard feature of the C911 and E911 Service.

Idle Tone Application:

This feature allows the PSAP attendant to distinguish between calls that have been abandoned before they are answered and calls where the calling party is unable to speak for some reason. If the caller abandoned the line before the PSAP attendant answered, a distinct tone is heard by the attendant. If the caller is still on the line but unable to speak, no tone will be heard. This feature is available with C911 and E911 Service.



GENERAL EXCHANGE TARIFF

UNITED TELEPHONE COMPANY
OF THE WEST
NEBRASKA

Section 19
Third Revised Sheet 10
Cancels Second Revised Sheet 10

N11 SERVICE

(T)

A. 911 Service (Cont'd)

3. EXPLANATION OF TERMS (Cont'd)

Public Safety Answering Point (PSAP):

A PSAP is an answering location for 911 calls originating in a given area. A PSAP may be designated as primary or secondary, which refers to the order in which calls are directed for answering. Primary PSAP's respond first, Secondary PSAP's receive calls on a transfer basis only. PSAP's are public service agencies such as police, fire, emergency medical, etc., or a common bureau serving a group of such entities.

Selective Routing (SR):

This feature routes a 911 call from a central office to the designated PSAP. This is an optional feature of the E911 Service.

Selective Transfer:

This feature transfers an incoming call to another agency by depressing a single button (e.g., "Fire" on the Display and Transfer Unit). This type of transfer is only available when the SR feature is provided. This is an optional feature of the E911 Service and may not be available from all central offices.

Service Area:

The geographical area in which the customer will respond to all 911 calls and dispatch appropriate emergency assistance.

Serving Central Office:

This is the Central Office(s) in which a PSAP, either a primary or secondary, is located.

Switchhook Status:

A feature that provides the PSAP attendant with visual indication of the calling party's switchhook status (on or off hook).

4. RATES

Rates for 911 Service shall be determined on a case by case basis as provided for under Sheets 5 and 6 of the "General Rules and Regulations Applying to Telephone Service" section of this tariff. Other charges outlined in the Local and General Exchange Tariffs may also apply.

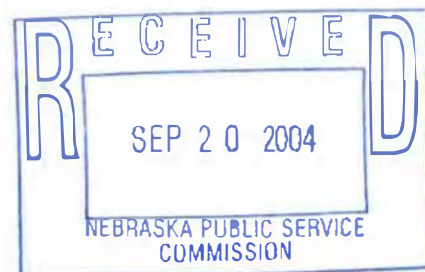

ISSUED:
September 20, 2004

BY: Warren D. Hannah
Director, Tariffs

EFFECTIVE:
September 30, 2004

GENERAL EXCHANGE TARIFF

UNITED TELEPHONE COMPANY
OF THE WEST
NEBRASKA

Section 19
First Revised Sheet 10.1
Cancels Original Sheet 10.1

N11 SERVICE

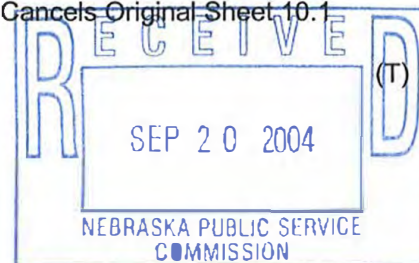

A. 911 Service (Cont'd)

5. WIRELESS E911 PHASE 2

a) Description of Service

Wireless E911 Phase 2 is only available in combination with E911 as specified in this section of the tariff and is subject to the regulations specified herein.

In accordance with the FCC's Report and Order 94-102, Wireless E911 Phase 2 provides PSAPs with the wireless E911 caller's location and callback number (CBN) information, as specified by the FCC. The FCC has adopted specific handset-based and network-based location accuracy and reliability solutions standards for the Wireless Service Providers (WSPs).

b) General Regulations

1. The Telephone Company is not responsible for the location determination technology, the accuracy of the location determination technology, or the investigation or maintenance of said technologies. Only the data required and specified by the FCC in its Report and Order 94-102 will be delivered by the Telephone Company to the PSAP. This required data includes the cell site or sector location, the callback number, and the latitude/longitude of the caller. Each customer agrees that delivery, or lack of delivery, of additional data elements which may be provided by the WSP will not be the responsibility of the Telephone Company and the Telephone Company assumes no responsibility or liability for such information.
2. PSAPs must have all required elements of Wireless E911 Phase 1, utilizing p-ANI routing and cell site/sector location based information, in place before implementing Phase 2. This is necessary to accommodate loading of the respective p-ANIs also known as Emergency Service Routing Key/Emergency Service Routing Digit into the Telephone Company's Database Management System. In addition, the following requirements must be met for Phase 2 implementation:
 - a) PSAPs must order both the Telephone Company's Extended ALI Display Format and the ALI Database Upgrade for Wireless Phase 2 to accommodate the x/y data provided by Wireless E911 Phase 2 Service. See rates in Section 19.A.5.f. following.
 - b) WSPs must have Position Determining Entity (PDE) and a Mobile Position Center (MPC)/Gateway Mobile Location Center (GMLC) in their network.
 - c) WSPs or their designated database provider must have obtained an interface to the Telephone Company's ALI database that complies with the Telephone Company's existing operating standard. This interface will be used by the WSP to provide the Phase 2 data.

GENERAL EXCHANGE TARIFF

UNITED TELEPHONE COMPANY
OF THE WEST
NEBRASKA

Section 19
First Revised Sheet 10.2
Cancels Original Sheet 10.2

N11 SERVICE

A. 911 Service (Cont'd)

5. WIRELESS E911 PHASE 2 (Cont'd)

c) Definition of Terms

1. Callback Number (CBN)

The wireless caller's 10-digit handset telephone number. The CBN is used by the PSAP to reestablish a call in the event the call was prematurely disconnected.

2. Interface

A reference point for a data path that exists between an MPC/GMLC and an ESME (the ALI database). The data that traverses the interface is made up of an Emergency Services Position Request and the response. The interface is not provided by and is not the responsibility of the Telephone Company.

3. Emergency Services Message Entity (ESME)

An entity in the emergency services network which serves as the point of interface to an MSC for common channel emergency services messaging. ESME is another term for the ALI database.

4. Enhanced MF Signaling (EMFS)

A signaling protocol for sending 10 or 20 digits of ANI from the 911 Tandem to the PSAP. EMF signaling is required when an interconnecting WSP selects Phase 2 NCAS mode without WLS911.

5. Mobile Position Center (MPC)

The interface between the wireless network and the Telephone Company's ALI database. The MPC serves as the wireless network entity which retrieves, forwards, stores, and controls position data within the wireless location network. The MPC is not provided by and is not the responsibility of the Telephone Company. Global System for Mobile (GSM) communication Gateway Mobile Location Centers (GMLCs) will be treated as MPCs by the Telephone Company.

6. Mobile Switching Center (MSC)

The wireless equivalent of a Central Office, which provides switching functions for wireless calls. The MSC is not provided by and is not the responsibility of the Telephone Company.



GENERAL EXCHANGE TARIFF

UNITED TELEPHONE COMPANY
OF THE WEST
NEBRASKA

Section 19
First Revised Sheet 10.3
Cancels Original Sheet 10.3

N11 SERVICE



A. 911 Service (Cont'd)

5. WIRELESS E911 PHASE 2 (Cont'd)

c) Definition of Terms (Cont'd)

7. Phase 2 NCAS

In this mode the p-ANI and the CBN both are sent to the Selective Router. The trunk between the Selective Router and the PSAP must support transport of at least two 10-digit numbers.

8. Position Determining Entity (PDE)

The PDE determines the geographic location of a wireless handset when the wireless caller places a 911 call or while the call is in process. The PDE is not provided by and is not the responsibility of the Telephone Company.

9. Pseudo-ANI (P-ANI)

A pseudo, non-dialable telephone number assigned to a cell site or a sector of a cell site to provide location identification for wireless E911 calls.

10. WLS911

The Telephone Company solution that sends either eight or ten digits of ANI to the PSAP and dynamically updates the static cell site or sector information with the CBN as provided by the WSP. This solution when used in conjunction with a WSP's interface allows WSPs to comply with the FCC's order without requiring PSAPs to upgrade their PSAP equipment to utilize Enhanced MF signaling.

11. Wireless Service Provider (WSP)

A person or entity that provides Commercial Mobile Radio Service (CMRS). The term wireless includes service provided by any wireless real-time, two-way voice communication device, including radio-telephone communications used in cellular telephone service, personal communication service (PCS), or functional or competitive equivalent. The term does not include service providers whose customers do not have access to 911 or 911-like services.

12. Wireline Compatibility Mode

Occurs when the WSP sends only p-ANI to the Telephone Company E911 tandem and the PSAP receives eight or ten digits of ANI.

13. X,Y Coordinates

The latitude and longitude of the 911 wireless caller's location.

GENERAL EXCHANGE TARIFF

UNITED TELEPHONE COMPANY
OF THE WEST
NEBRASKA

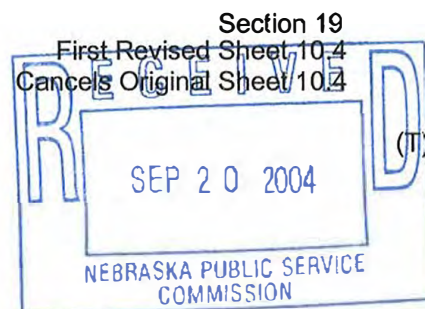

N11 SERVICE

A. 911 Service (Cont'd)

5. WIRELESS E911 PHASE 2 (Cont'd)

d) Enhanced MF

Enhanced MF (EMF) is a new signaling protocol from the 911 Tandem to the PSAP. Enhanced MF accommodates either ten or 20 digits of ANI. Enhanced MF is not a requirement of Wireless Phase 2 implementation but EMF must be used by PSAPs when an interconnecting Wireless Service Provider chooses the Phase 2 NCAS Mode (as defined in J-STD-036 Annex D, Table D.1.2. and/or D.2.), without WLS911. If an interconnecting WSP chooses a Phase 2 NCAS solution without WLS911, the PSAP's equipment must be 20-digit Enhanced MF capable. The PSAP must request the Telephone Company convert them to EMF signaling when preparing to accept Phase 2 calls from a WSP utilizing Phase 2 NCAS without WLS911. Once a PSAP has been converted to 20 digit EMF Signaling the functionality of WLS911 is disabled for all WSPs serving that PSAP.

e). Wireless E911 Phase 2 Service

This service is comprised of two components, Extended ALI Display Format and ALI Database Upgrade for Wireless Phase 2. Both components are required for implementation of this service.

1. Extended ALI Display Format

The PSAP's Automatic Location Identification (ALI) display format must be changed to the Telephone Company's Extended ALI Display Format to accommodate the latitude and longitude, or x,y coordinates. The provision and delivery of the x,y information to the PSAP requires an interface between the ALI database and the WSP's Mobile Position Center (MPC)/Gateway Mobile Location Center (GMLC). The provisioning of the interface is the responsibility of the WSP.

2. ALI Database Upgrade for Wireless Phase 2

The ALI Database Upgrade for Wireless Phase 2 enables the PSAP to query and retrieve wireless caller location information from the Telephone Company's Automatic Location Identification (ALI) database. Location information may include cell site sector location, longitude and latitude of the wireless caller's location, and the wireless caller's callback number (CBN). This upgrade will enable the necessary interfaces, software, and databases to permit the wireless caller's location information to be populated in the Telephone Company's ALI database and/or retrieved when queried by the customer's PSAP equipment.

GENERAL EXCHANGE TARIFF

UNITED TELEPHONE COMPANY
OF THE WEST
NEBRASKA

Section 19
First Revised Sheet 10.5
Cancels Original Sheet 10.5

N11 SERVICE

(T)

A. 911 Service (Cont'd)

5. WIRELESS E911 PHASE 2 (Cont'd)

f) Rates and Charges

	<u>Nonrecurring Charge</u>	<u>Monthly Rate</u>	<u>SAE Code</u>
1. Enhanced MF signaling, per PSAP	\$0.00	\$0.00	-
2. Extended ALI Display Format, per PSAP	\$3,500.00	\$0.00	-
3. ALI Database Upgrade for Wireless Phase 2, per PSAP	\$0.00	\$250.00	AEMDATA (WLS)



ISSUED:
September 20, 2004

BY: Warren D. Hannah
Director, Tariffs

EFFECTIVE:
September 30, 2004

GENERAL EXCHANGE TARIFF

UNITED TELEPHONE COMPANY
OF THE WEST
NEBRASKA

Section 19
First Revised Sheet 11
Cancels Original Sheet 11

N11 SERVICE

(T)

B. 711 Service For Telecommunications Relay Services (TRS)

1. General

- a) 711 Dialing Code ("711") is a three digit local dialing arrangement for telephone voice transmission access to all certified Telecommunications Relay Services entities as a toll free call. Pursuant to Order 00-257, issued by the Federal Communications Commissions (FCC) in CC Docket 92-105, the FCC assigned 711 dialing code for nationwide access to Telecommunications Relay Services (TRS) entities, to be implemented not later than October 1, 2001.
- b) 711 is available from the Company within the Company's service area only. To provide access to 711 to end users in another company service area or to a Competitive Local Exchange Carrier (CLECs) end users within the local calling area, the TRS entity must make appropriate arrangements with the other company or CLEC serving that territory. The TRS entity should work separately with competing local providers to ascertain that its end user customers will be able to reach relay services provided by dialing 711.
- c) This service is subject to the availability of the 711 dialing code.
- d) 711 can be delivered via regular exchange access lines (by individual business lines, PBX trunks, etc.).
- e) Limitations and use of service are as stated in the General Rules and Regulations of this Tariff.
- f) Directory Listings may be provided for 711 at rates and regulations as specified in Section 4 of this Tariff.
- g) Access to 711 is not available to the following classes of service:
 - Hotel/Motel/Hospital Service (toll call only)
 - 1+
 - 0+, 0- (Credit Card, Third-Party Billing, Collect Calls)
 - Inmate Service
 - 101XXXX
 - Cellular - Type 2AIn addition, operator assisted calls to 711 will not be completed



ISSUED:
September 20, 2004

BY: Warren D. Hannah
Director, Tariffs

EFFECTIVE:
September 30, 2004

GENERAL EXCHANGE TARIFF

UNITED TELEPHONE COMPANY
OF THE WEST
NEBRASKA

Section 19
First Revised Sheet 12
Cancels Original Sheet 12

N11 SERVICE

(T)

B. 711 Service For Telecommunications Relay Services (TRS) (Cont'd)

2. Obligations of the TRS Entity

- a) The TRS entity must, prior to provisioning of the service, sign a written acknowledgement of possible recall of the 711 dialing code by the FCC and an agreement to return the code upon receipt of 6 months written notice of such a recall from the Company or regulating entity and abide by all terms and conditions which may be identified by the FCC in CC Docket 92-105 regarding the use and return of the 711 dialing code. If a recall is effected, the Company will work with the TRS entity affected by such recall to transfer their service arrangements, to a 7 or 10-digit dialing arrangement within the 6-month notice period. The TRS entity will be required to migrate to any access arrangement the telecommunications relay services subsequently agreed to by the industry and approved by the FCC. The TRS entity will be charged the appropriate tariff rates for the establishment of the new access arrangement.
- b) The TRS entity should work separately with wireless companies to ascertain their end user customers will be able to reach telephone relay services provided by dialing 711.
- c) The TRS entity should work separately with competitive local exchange companies to ascertain their end user customers will be able to reach telephone relay services provided by dialing 711.
- d) The TRS entity is restricted from selling or transferring the 711 dialing code to an unaffiliated entity, either directly or indirectly.
 1. An "affiliate" of a TRS entity is any entity that directly, or indirectly through one or more intermediaries, controls, is controlled by, or is under common control with the TRS entity. The term "control" (including the terms "controlling," "controlled by," and "under common control with") means the possession, direct or indirect, of the power to direct or cause the direction of the management and policies of an entity, whether through the ownership of voting securities, by contract, or otherwise.

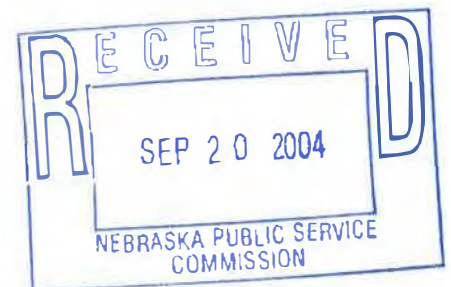

ISSUED:
September 20, 2004

BY: Warren D. Hannah
Director, Tariffs

EFFECTIVE:
September 30, 2004

GENERAL EXCHANGE TARIFF

UNITED TELEPHONE COMPANY
OF THE WEST
NEBRASKA

Section 19
First Revised Sheet 13
Cancels Original Sheet 13

N11 SERVICE

(T)

B. 711 Service For Telecommunications Relay Services (TRS) (Cont'd)

2. Obligations of the TRS Entity (Cont'd)

- e) The 711 Dialing Code will be provided by the Company to the TRS entity under the following conditions:
1. For network sizing and protection, the TRS entity must provide an estimate of annual call volumes, the expected busy hour and the expected holding time for each call to the 711 dialing code.
 2. The TRS entity will subscribe to adequate telephone facilities initially and subsequently as may be required, in the judgment of the Company, to adequately handle calls to 711 without impairing the Company's general telephone service or telephone facilities.
 3. The TRS entity is responsible for obtaining all necessary permission, licenses, written consents, waivers, releases and all other rights from all persons whose work, statements or performance are used in connection with the 711 dialing code, and from all holders of copyrights, trademarks, and patents used in connection with said service.
- f) If a pre-recorded announcement is provided by the TRS entity, the following conditions apply:
1. The TRS entity will provide announcements. The company will provide only the delivery of the call.
 2. The provision of access to the 711 network by the Company for the transmission of announcement is subject to availability of such facilities and the requirements of the local exchange network.
 3. The TRS entity assumes all financial responsibility for all costs involved in providing announcement including, but not limited to, the recorder-announcement equipment located on the TRS entity's premises.
 4. The TRS entity assumes, according to other specific rates and charges under tariff, all financial responsibility for all facilities required, to connect the recorder-announcement equipment located on the TRS entity's premises.



ISSUED:
September 20, 2004

BY: Warren D. Hannah
Director, Tariffs

EFFECTIVE:
September 30, 2004

GENERAL EXCHANGE TARIFF

UNITED TELEPHONE COMPANY
OF THE WEST
NEBRASKA

Section 19
First Revised Sheet 14
Cancels Original Sheet 14

N11 SERVICE

(T)

B. 711 Service For Telecommunications Relay Services (TRS) (Cont'd)

3. Obligations of the Company

- a) Once the 711 Dialing Code has been assigned and the subscriber has provided the Company the appropriate toll free number, implementation of the 711 Dialing Code will begin. The Company will implement the TRS entity's request within a reasonable time, given the complexity of the order.

If, during or at the end of the provisioning period, the TRS entity has failed to establish service or decides to discontinue service establishment, the 711 code will be recalled and the number will be considered available for reassignment.

- b) When a 711 Service call is placed by the calling party via interconnection with an interexchange carrier, the Company cannot guarantee the completion of said 711 Service call, the quality of the call or any features that otherwise may be provided with 711 dialing service.

4. Obligations of the Competitive Local Exchange Carrier (CLEC)

- a) In those instances where a CLEC provides the 711 dialing code to its end user within the local calling area, terms and conditions for 711 dialing code are as defined in the appropriate Interconnection Agreement.
1. For purposes of providing a CLEC end user access to the TRS entity within the local calling area, appropriate arrangements must be made by the CLEC with the TRS entity serving the local calling area.
 2. A CLEC may negotiate the provision of directory listing as defined in the Interconnection Agreement.



GENERAL EXCHANGE TARIFF

UNITED TELEPHONE COMPANY
OF THE WEST
NEBRASKA

Section 19
First Revised Sheet 15
Cancels Original Sheet 15

N11 SERVICE

(T)

B. 711 Service For Telecommunications Relay Services (TRS) (Cont'd)

5. Liability

- a) The TRS entity is responsible for, and shall indemnify, protect, defend and save harmless the Company against all suits, actions, claims, demands and judgments, and of all costs, expenses and counsel fees incurred on account thereof, arising out of and resulting directly or indirectly from the service or in connection therewith, including, but not limited to, any loss, damage, expense or liability resulting from any infringement or claim of infringement, of any patent, trademark, copyright, or resulting from any claim of libel and slander. Unless otherwise specifically provided in this Tariff, the Company shall be authorized to disconnect any tariffed service provided to the TRS entity utilized, directly or indirectly, with the 711 dialing code, which fails to comply with regulations and conditions set forth herein, upon five (5) days of notice to the subscriber. Disconnection may be suspended at the discretion of the Company if it receives written certification that the TRS entity is in compliance with regulations and conditions of the tariffs. Continual noncompliance shall be cause for disconnection without notice at the discretion of the Company.
- b) The TRS entity shall respond promptly to any and all complaints lodged with any regulatory authority against any service provided via the 711 dialing code. If requested by the Company, the TRS entity shall assist the Company in responding to complaints made to the Company concerning the 711 dialing code.
- c) A written notice will be sent to any TRS entity following oral notification when their service unreasonably interferes with or impairs other services rendered to the public by the Company. If after notification the TRS entity makes no modification in method of operation or in the service arrangements that are deemed service-protective by the Company, or if the TRS entity is unwilling to accept the modifications, or if the TRS entity continues to cause service impairment, the Company reserves the right, at any time, without further notice, to institute protective measures, up to and including termination of service. In an emergency situation as defined by the Company, the Company reserves the right, at any time, without notice, to institute protective measures up to and including termination of service.
- d) The Company may take all legal and practical steps to disassociate itself from the TRS entity providing services whose business and/or public conduct (whether demonstrated or proposed) is of a type that in the Company's discretion generates unacceptable levels of complaints by end users.



ISSUED:
September 20, 2004

BY: Warren D. Hannah
Director, Tariffs

EFFECTIVE:
September 30, 2004

GENERAL EXCHANGE TARIFF

UNITED TELEPHONE COMPANY
OF THE WEST
NEBRASKA

Section 19
First Revised Sheet 16
Cancels Original Sheet 16

N11 SERVICE

(T)

B. 711 Service For Telecommunications Relay Services (TRS) (Cont'd)

5. Liability (Cont'd)

- e) In no event shall the Company be liable for any losses or damages of any kind resulting from the unavailability of its equipment or facilities or for any act, omission or failure of performance by the Company, or its employees, or agents, in connection with this Tariff. The Company shall not be responsible for calls that cannot be completed as a result of repair or maintenance difficulties on Company facilities and equipment nor on equipment owned or leased by the TRS entity.

6. Other Terms and Conditions

- a) Only one 10-digit toll free number may be used as the lead number per basic local calling area.
- b) The 711 Dialing Code is provided where facilities permit.
- c) The 711 Service will not provide calling number information in real time to the TRS entity. If this type of information is required, the TRS entity must subscribe to compatible Caller ID Service as described in Section 12 of the Price List.
- d) The 711 Service is provided solely for the benefit of the TRS entity. The provision of the 711 Service by the Company shall not be interpreted, constructed, or regarded, either expressly or implied, as being for the benefit of or creating any Company obligation toward any third person or legal entity other than the TRS entity.

7. Rates and Charges

- a) The 711 Service is ordered by the F.C.C. to be provided without charge. Therefore, there are no rates or charges for the 711 Service.



ISSUED:
September 20, 2004

BY: Warren D. Hannah
Director, Tariffs

EFFECTIVE:
September 30, 2004

GENERAL EXCHANGE TARIFF

UNITED TELEPHONE COMPANY
OF THE WEST
NEBRASKA

Section 19
First Revised Sheet 17
Cancels Original Sheet 17

N11 SERVICE

(T)

C. Non-Emergency 311 Service

1. General

- a) Non-Emergency 311 Service (NE311) is a local telephone exchange communications service which allows Company subscribers to reach non-emergency local government services by dialing an abbreviated telephone number. The Federal Communications Commission (FCC) reserved the abbreviated telephone number, 3-1-1, for non-emergency access to public services. NE311 Service is an optional service which may be purchased by a local municipality, state or local governmental unit to whom authority has been lawfully delegated. The NE311 Service Provider must be granted authority by the appropriate city, county, or state officials to provide the service.
- b) NE311 Service allows a Company subscriber to access an approved NE311 Service Provider by dialing only the 311 abbreviated dialing code. Subject to other terms and conditions of this Tariff, Company subscribers shall be able to make and the NE311 Service Provider shall be able to receive calls using the NE311 Service as part of their local exchange services. The NE311 Service is supplemental to and is not a replacement for either party's local exchange service.
- c) All NE311 Service calls must be local in nature and shall not result in any intraLATA toll, interLATA long distance or pay-per-call charges to Company subscribers. However, NE311 Service calls may result in local measured service charges where Company subscribers' service plans include such charges as part of Extended Area Service (EAS) exchange calling. (D)
(D)
- d) The NE311 Service is not available for the following classes of service: inmate service, 1+ and 0+ calling, 0- operated assisted calling and 101XXXX calling. NE311 Service is otherwise available wherever local service is accessible.
- e) Only calls originating within a NE311 Service Provider's area of jurisdiction (the "NE311 Service Area") will be routed to a call center/answering point designated by the NE311 Service Provider. There can be only one NE311 Service Provider in each geographic area. NE311 Service areas may not overlap. This assures that NE311 calls from a telephone line within a NE311 Service Area can be routed to a unique NE311 call center/answering point.
- f) NE311 Service is offered subject to the availability of facilities.



ISSUED:
September 20, 2004

BY: Warren D. Hannah
Director, Tariffs

EFFECTIVE:
September 30, 2004

GENERAL EXCHANGE TARIFF

UNITED TELEPHONE COMPANY
OF THE WEST
NEBRASKA

Section 19
Second Revised Sheet 18
Cancels First Revised Sheet 18

N11 SERVICE

C. Non-Emergency 311 Service (Cont'd)

2. Obligations of the Non-Emergency 311 Service Provider

- a) The NE311 Service Provider must submit a written application for NE311 Service on a Company local exchange by local exchange basis. The NE311 Service Provider may establish NE311 Service in all or part of the Company's local exchanges. There may be only one NE311 Service Provider per exchange.
- b) The NE311 Service Provider's written application to establish NE311 Service in a Company local exchange shall include the following:
 1. The unpublished local telephone number into which the Company is to translate the dialed NE311 abbreviated code. If the NE311 Service Provider desires to change the telephone number into which the NE311 abbreviated dialing code is translated, the NE311 Service Provider must pay the Number Change Charge specified in Section 19.C.6.g following.
 2. A location description of the NE311 Service Provider call center where NE311 calls made from the Company local exchange will be routed.
 3. For network sizing and protection, an estimate of annual call volumes, the expected busy hour and holding time for each call to the NE311 Service.
 4. An acknowledgment of the possibility that the Commission's assignment of the NE311 abbreviated dialing code may be recalled at any time.
- c) Local Calling for Company Subscribers
 1. The NE311 Service Provider, in cooperation with the Company, shall assure that all NE311 Service calls are local in nature and do not generate intraLATA toll, interLATA long distance or pay-per-call charges for Company subscribers. (T)
 2. When the NE311 Service Provider applies for NE311 Service in a Company local exchange, the NE311 Service Provider shall supply the Company with an unpublished seven or ten digit telephone number that terminates within the Company local exchange's local calling area. The Company will translate the dialed NE311 dialing code into the telephone number provided by the NE311 Service Provider.
 3. When the NE311 Service Provider applies for NE311 Service in a Company local exchange and a NE311 Service Provider call center is not located within the local exchange's local calling area, then the NE311 Service Provider shall establish foreign exchange service or supply the Company with a toll free telephone number so that Company subscribers' NE311 Service calls do not incur toll charge.

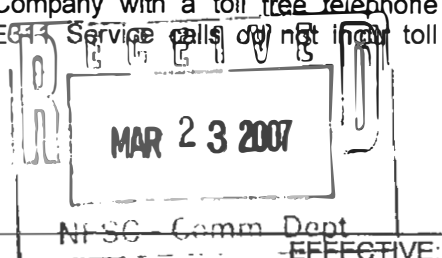

ISSUED:
March 23, 2007

BY: Darlene Terry
Manager, Tariffs

EFFECTIVE:
April 2, 2007

GENERAL EXCHANGE TARIFF

UNITED TELEPHONE COMPANY
OF THE WEST
NEBRASKA



N11 SERVICE

C. Non-Emergency 311 Service (Cont'd)

2. Obligations of the Non-Emergency 311 Service Provider (Cont'd)

- d) The NE311 Service Provider is liable for and will indemnify, protect, defend and hold harmless the Company against all suits, actions, claims, demands and judgments, plus any expenses and counsel fees incurred by the Company on account thereof, whether suffered, made, instituted or asserted by the NE311 Service Provider or any other party or person, for any personal injury to or death of any person or persons, or for any loss, damage or destruction of any property, whether owned by the NE311 Service Provider or others, arising out of or resulting directly or indirectly from the NE311 Service. (T)
- e) The NE311 Service Provider must develop an appropriate method for responding to NE311 calls directed to it out of confusion or in error by Company subscribers. This includes calls from customers that reside within the Company local exchange but outside the legally designated jurisdiction of the NE311 Service Provider (i.e. exchange boundaries that cross county borders).
- f) The NE311 Service Provider must subscribe to termination facilities and lines in sufficient quantities to provide adequate service to the public, **and enable the NE311 Service Provider to receive calls to the NE311 Service during normal business hours.** (T)
(T)
- g) NE311 Service is provided on the condition that the NE311 Service Provider subscribes to termination facilities and lines in sufficient quantities to adequately handle calls to the NE311 Service without interfering with or impairing any services offered by the Company. There will be one path available for each line to **which** the NE311 Service Provider **subscribes.** (T)
(T)
- h) The NE311 Service Provider must comply with all present and future **state and federal** rules pertaining to abbreviated dialing codes, **including any and all requirements to relinquish the 311 abbreviated dialing code in the event of a national assignment contrary to that made by the Nebraska Public Service Commission.** (T)
(T)
- i) The NE311 Service Provider is responsible for obtaining all necessary permissions, licenses, written consents, waivers and releases and all other rights from all persons whose work, statements or performances are used in connection with the 311 Service, and from all holders of copyrights, trademarks and patents used in connection with the said service.
- j) The NE311 Service Provider must respond promptly to any and all complaints lodged with any regulatory authority against the NE311 Service. If requested by the Company, the NE311 Service Provider shall assist the Company in responding to complaints made to the Company concerning the NE311 Service.
- k) The NE311 Service Provider shall not promote the NE311 Service with the use of an autodialer or broadcasting of tones that dial the NE311 abbreviated dialing code.

GENERAL EXCHANGE TARIFF

UNITED TELEPHONE COMPANY
OF THE WEST
NEBRASKA

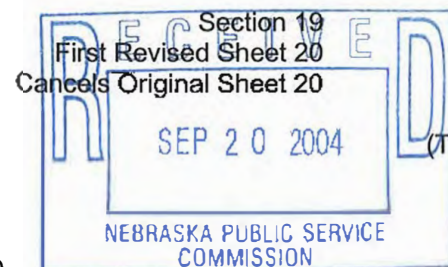

N11 SERVICE

C. Non-Emergency 311 Service (Cont'd)

2. Obligations of the Non-Emergency 311 Service Provider (Cont'd)

- l) NE311 Service *is only* available to end users located in Company local exchanges. To establish NE311 calling to end users in non-Company local exchanges, the NE311 Service Provider must make appropriate arrangements with the companies serving those local exchanges, even where Company subscribers may make local calls to the non-Company local exchanges. (T)
- m) The NE311 Service Provider must work separately with competitive local exchange carriers operating and serving customers in the Company's local exchanges to ascertain whether NE311 abbreviated dialing will be available to their end users.
- n) In the event that an end user misdials and reports an emergency by dialing 311, the NE311 Service Provider agrees to release, indemnify, defend, and save harmless the Company from claims, suits, actions, damages, costs, judgments, actions of every name and description arising out of or due to acts or omissions of the NE311 Service Provider, its agents and its employees while answering and dispatching 311 calls.

3. Obligations of the Company

- a) The Company *will establish* the NE311 Service within ninety days *after* receipt of the NE311 Service Provider's completed application(s) for service *or of* the effective date of this tariff, *whichever is later*. (T)
(T)
- b) When an NE311 Service call is placed by the calling party via interconnection with an interexchange carrier, the Company cannot guarantee the completion of said NE311 Service call, the quality of the call or any features that may otherwise be provided with NE311 Service.
- c) The Company will route NE311 calls originating from end users on the Company's local exchange network whether they purchase service directly from the Company or from another provider reselling Company service. Otherwise, the Company is not responsible for establishing NE311 Service for calls originating from other telecommunications providers.
- d) The Company does not undertake to answer and forward NE311 Service calls but furnishes the use of its facilities to enable the NE311 Service Provider to respond to such calls at NE311 Service Provider established call centers.
- e) The rates charged for NE311 Service do not contemplate the inspection or constant monitoring of facilities to discover errors, defects, and malfunctions in service, nor does the Company undertake such responsibility. The NE311 Service Provider shall make such operational tests as, in the judgment of the NE311 Service Provider, are required to determine whether the Company's facilities are functioning properly for its use. The NE311 Service Provider shall promptly notify the Company in the event the Company's facilities are not functioning properly.

ISSUED:
September 20, 2004

BY: Warren D. Hannah
Director, Tariffs

EFFECTIVE:
September 30, 2004

GENERAL EXCHANGE TARIFF

UNITED TELEPHONE COMPANY
OF THE WEST
NEBRASKA

Section 19
First Revised Sheet 21
Cancels Original Sheet 21

N11 SERVICE

(T)

C. Non-Emergency 311 Service (Cont'd)

3. Obligations of the Company (Cont'd)

- f) NE311 Service is furnished subject to all operating failures and interruptions, including, but not limited to, equipment breakdowns, errors, defects, malfunctions and interruptions of service experienced in the regular telephone exchange system. The rates provided for this service are subject to the limitations which appear in this section and in other applicable sections of this and other tariffs. The Company does not undertake to provide a higher level of service reliability and quality than the telephone exchange service being provided in the exchange that NE311 Service is offered.

4. Liability

- a) The liability of the Company for losses or damages of any kind arising out of mistakes, omissions, interruptions, delays, errors or defects in transmission, or failure or defects in any facility furnished by the Company, occurring in the course of furnishing NE311 Service, or of the Company in failing to maintain proper standards of maintenance and operation or to exercise reasonable supervision, shall in no event exceed an amount equivalent to the proportionate charge to the NE311 Service Provider for the NE311 Service and local exchange services for the period of service during which such mistake, omission, interruption, delay, error or defect in transmission or defect or failure in facilities occurs. The Company has no liability for losses or damages caused by the negligence of the NE311 Service Provider.
- b) The Company's entire liability to any person for interruption or failure of the NE311 Service shall be limited to the terms set forth in this section and other sections of this Tariff.
- c) The Commission's local assignment and the NE311 Service Provider's use of the 311 abbreviated dialing code is subject to preemption by the Federal Communications Commission. The Company shall not be liable to the NE311 Service Provider for any damages the NE311 Service Provider may incur that results from a national assignment of the 311 abbreviated dialing code.
- d) The Company accepts no responsibility for obtaining subscriber record information from telephone end users.
- e) The Company will make every effort to route NE311 calls to the appropriate NE311 Service Provider calling center, however, the Company will not be held responsible for routing mistakes or errors.



ISSUED:
September 20, 2004

BY: Warren D. Hannah
Director, Tariffs

EFFECTIVE:
September 30, 2004

GENERAL EXCHANGE TARIFF

UNITED TELEPHONE COMPANY
OF THE WEST
NEBRASKA

Section 19
First Revised Sheet 22
Cancels Original Sheet 22

N11 SERVICE

(T)

C. Non-Emergency 311 Service (Cont'd)

5. Other Terms and Conditions

- a) The NE311 Service will not provide calling number information in real time to the NE311 Service Provider. If this type of information is required, the NE311 Service Provider must subscribe to compatible Caller ID service as described in Section 12 of the **United Telephone Company of the West Nebraska General Exchange Price List**. ***The Caller ID Service will only provide calling number information as described in Section 12 of the United Telephone Company of the West Nebraska General Exchange Price List.***
- b) The NE311 Service is provided for the benefit of the NE311 Service Provider. The provision of the NE311 Service by the Company shall not be interpreted, constructed or regarded, either expressly or implied, as being for the benefit of or creating any Company obligation toward any third person or legal entity other than the NE311 Service Provider.
- c) A written notice will be sent to the NE311 Service Provider following oral notification when its NE311 Service unreasonably interferes with or impairs other services rendered to the public by the Company or by other subscribers of abbreviated dialing codes. If after notification the NE311 Service Provider makes no modification in method of operation or in the service arrangements that are deemed service-protective by the Company, or if the NE311 Service Provider is unwilling to accept the modifications, or if the NE311 Service Provider continues to cause service impairment, the Company reserves the right, at any time, without further notice, to institute protective measures, up to and including termination of service. In an emergency situation as defined by the Company, the Company reserves the right, at any time, without notice, to institute protective measures, up to and including termination of service.

(T)

(T)

(T)



ISSUED:
September 20, 2004

BY: Warren D. Hannah
Director, Tariffs

EFFECTIVE:
September 30, 2004

GENERAL EXCHANGE TARIFF

UNITED TELEPHONE COMPANY
OF THE WEST
NEBRASKA

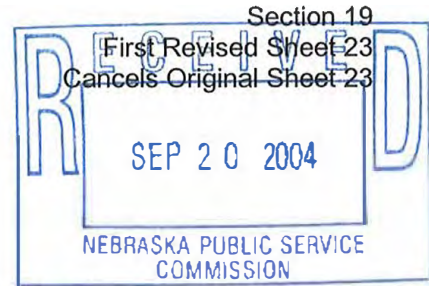

N11 SERVICE

(T)

C. Non-Emergency 311 Service (Cont'd)

6. Rates

- a) The nonrecurring charges associated with the initial NE311 Service establishment are specified in Section 19.C.6.g. following. These are one-time charges which apply only when the NE311 Service Provider establishes or modifies NE311 Service.
- b) The NE311 Service Provider shall pay a nonrecurring Central Office Charge for each Company host central office out of which NE311 Service is established.
 - 1. Some Company local exchanges are served by more than one host central office. In order to establish NE311 Service in such an exchange, the NE311 Service Provider shall pay a Central Office Charge for each host central office in the Company local exchange.
 - 2. Some host central offices serve more than one Company local exchange. If the NE311 Service Provider makes applications to establish NE311 Service in multiple Company local exchanges served by the same host central office, then only one Central Office Charge shall apply. However, the full Central Office Charge applies whether or not the NE311 Service Provider requests NE311 Service in all the Company local exchanges served by that host central office.
- c) An Exclusion Charge Applies *in lieu of a Central Office Charge* for the establishment of NE311 Service as follows:
 - 1. When the NE311 Service Provider does not simultaneously establish NE311 Service in every Company local exchange served by a host central office, the NE311 Service Provider shall pay an Exclusion Charge *per* host central office **if any local exchange(s) are excluded from the translation.**
 - 2. When a Company local exchange is once excluded, but the NE311 Service Provider later applies to establish NE311 Service in the Company local exchange, **then** an Exclusion Charge applies *per host central office when a local exchange* continues to be excluded **from the translation**
 - 3. When the NE311 Service Provider requests a different telephone number be translated to the 311 abbreviated dialing code in a participating **Company local exchange other** than the telephone number translated to the 311 abbreviated dialing code in the host central office, **then an Exclusion Charge applies per host central office.**
- d) A nonrecurring Number Change Charge applies when the NE311 Service Provider changes the telephone number into which the NE311 abbreviated dialing code is translated. The Number Change Charge shall be applied on a per telephone number, per host central office basis.

(T)

(T)

(T)

(T)

(T)

(T)

|

(T)

(M)

|

(M)

(M) Material previously found on this sheet now appears on First Revised Sheet 24.

GENERAL EXCHANGE TARIFF

UNITED TELEPHONE COMPANY
OF THE WEST
NEBRASKA

Section 19
First Revised Sheet 24
Cancels Original Sheet 24

N11 SERVICE

(T)

C. Non-Emergency 311 Service (Cont'd)

6. Rates (Cont'd)

- e) **When translating the seven or ten digit number to the 311 abbreviated dialing code**, applicable Service Connection Charges as specified in Section 18 of this tariff will apply **as follows**, in addition to the rates listed below. (T) (M)
(T)
- 1. **A simple business rate Record Order Charge per order, as found in Section 18 of this tariff.** (N)
(N)
- f) The minimum service period for NE 311 Service is one month. (T) (M)
- g) Rates

(D)

	<u>Nonrecurring Charge</u>	
1. Central Office Charge (per host Central Office)	\$ 175.00	(T)
2. Exclusion Charge (per host Central Office)	325.00	(T)
3. Number Change Charge (per telephone number)	35.00	(T)



(M) Material now appearing on this sheet was previously found on Original Sheet 23.

ISSUED:
September 20, 2004

BY: Warren D. Hannah
Director, Tariffs

EFFECTIVE:
September 30, 2004

GENERAL EXCHANGE TARIFF

UNITED TELEPHONE COMPANY
OF THE WEST
NEBRASKA

Section 19
First Revised Sheet 25
Cancels Original Sheet 25

N11 SERVICE

(T)

D. 211 Service for Information and Referral Service

1. General Regulations

- a) The 211 Service for Information and Referral Service (211 Service) is a locally assigned three digit abbreviated dialing code provided to an Approved Information and Referral Service Provider for use in making available community information and referral services to the public by way of voice grade facilities. The 211 abbreviated dialing code is available to the Approved Information and Referral Service Provider as a tariffed, local calling area based service (the "211 Service").
- b) The 211 Service allows a Company subscriber to access an Approved Information and Referral Service Provider call center by dialing only the 211 abbreviated dialing code. Subject to other terms and conditions of this Tariff, Company subscribers shall be able to make and the Approved Information and Referral Service Provider shall be able to receive calls using the 211 Service as part of their local exchange services. The 211 Service is supplemental to and is not a replacement for either party's local exchange service.
- c) All 211 abbreviated dialing code calls must be local in nature and must not result in any intraLATA toll, interLATA long distance or pay-per-call charges to Company subscribers. However, 211 Service calls may result in local measured service charges where Company subscribers' service plans include such charges as part of local measured service or home exchange service calling plans.
- d) The 211 Service is not available for the following classes of service: inmate service, 1+ and 0+ calling, 0- operator assisted calling and 101XXXX calling. The 211 Service is otherwise available wherever local service is available.

2. Obligations of the Approved Information and Referral Service Provider

- a) The Approved Information and Referral Service Provider must submit a written application for 211 Service to the Company at the local exchange level. The Approved Information and Referral Service Provider may establish 211 Service in all or part of the Company's local exchanges. There may be only one 211 Service Provider per exchange.



ISSUED:
September 20, 2004

BY: Warren D. Hannah
Director, Tariffs

EFFECTIVE:
September 30, 2004

GENERAL EXCHANGE TARIFF

UNITED TELEPHONE COMPANY
OF THE WEST
NEBRASKA

Section 19
First Revised Sheet 26
Cancels Original Sheet 26

N11 SERVICE

(T)

D. 211 Service for Information and Referral Service (Cont'd)

2. Obligations of the Approved Information and Referral Service Provider (Cont'd)

b) The Approved Information and Referral Service Provider's written application to establish 211 Service in a Company local exchange must include the following:

1. The local, foreign exchange or toll free telephone number into which the Company is to translate the dialed 211 abbreviated code. If the Approved Information and Referral Service Provider desires to change the telephone number into which the 211 abbreviated dialing code is translated, the Approved Information and Referral Service Provider must pay the Number Change Charge specified in Section 19.D.6.f.
2. A location description of the Approved Information and Referral Service Provider call center where 211 calls made from the Company local exchange will be routed.
3. For network sizing and protection, an estimate of annual call volumes, the expected busy hour and holding time for each call to the 211 Service.
4. An acknowledgment of the possibility that the Commission's assignment of the 211 abbreviated dialing code may be recalled at any time.

c) Local Calling for Company Subscribers

1. The Approved Information and Referral Service Provider, in cooperation with the Company, must assure that all 211 Service calls are local in nature and do not generate intraLATA toll, interLATA long distance or pay-per-call charges for Company subscribers.
2. When the Approved Information and Referral Service Provider applies for 211 Service in a Company local exchange, the Approved Information and Referral Service Provider must supply the Company with a seven or ten digit telephone number that terminates within the Company local exchange's local calling area. The Company will translate the 211 digits into the telephone number provided by the Approved Information and Referral Service Provider.
3. When the Approved Information and Referral Service Provider applies for 211 Service in a Company local exchange and an Approved Information and Referral Service Provider call center is not located within the local exchange's local calling area, then the Approved Information and Referral Service Provider must establish foreign exchange service or supply the Company with a toll free telephone number so that Company subscribers' 211 Service calls do not incur toll charges.

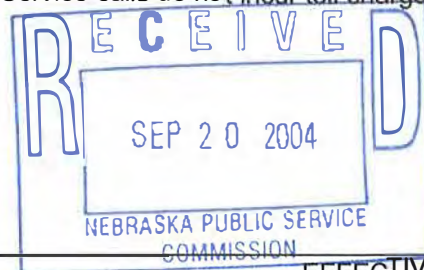

ISSUED:
September 20, 2004

BY: Warren D. Hannah
Director, Tariffs

EFFECTIVE:
September 30, 2004

GENERAL EXCHANGE TARIFF

UNITED TELEPHONE COMPANY
OF THE WEST
NEBRASKA

Section 19
First Revised Sheet 27
Cancels Original Sheet 27

N11 SERVICE

(T)

D. 211 Service for Information and Referral Service (Cont'd)

2. Obligations of the Approved Information and Referral Service Provider (Cont'd)

- d) The Approved Information and Referral Service Provider is liable for and will indemnify, protect, defend and hold harmless the Company against all suits, actions, claims, demands and judgments, plus any expenses and counsel fees incurred by the Company on account thereof, whether suffered, made, instituted or asserted by the Approved Information and Referral Service Provider or any other party or person, for any personal injury to or death of any person or persons, or for any loss, damage or destruction of any property, whether owned by the Approved Information and Referral Service Provider or others, arising out of or resulting directly or indirectly from the 211 Service.
- e) The Approved Information and Referral Service Provider must develop an appropriate method for responding to 211 calls directed to it out of confusion or in error by Company subscribers.
- f) The Approved Information and Referral Service Provider must subscribe to termination facilities and lines in sufficient quantities to provide adequate service to the public, and enable the Approved Information and Referral Service Provider to receive calls to the 211 Service during normal business hours.
- g) The 211 Service is provided on the condition that the Approved Information and Referral Service Provider subscribes to termination facilities and lines in sufficient quantities to adequately handle calls to the 211 Service without interfering with or impairing any services offered by the Company. There will be one path available for each line to which the 211 Provider subscribes.
- h) The Approved Information and Referral Service Provider must comply with all present and future state and federal rules pertaining to abbreviated dialing codes.
- i) The Approved Information and Referral Service Provider is responsible for obtaining all necessary permissions, licenses, written consents, waivers and releases and all other rights from all persons whose work, statements or performances are used in connection with the 211 Service, and from all holders of copyrights, trademarks and patents used in connection with the said service.
- j) The Approved Information and Referral Service Provider shall respond promptly to any and all complaints lodged with any regulatory authority against the 211 Service. If requested by the Company, the Approved Information and Referral Service Provider will assist the Company in responding to complaints made to the Company concerning the 211 Service.



ISSUED:
September 20, 2004

BY: Warren D. Hannah
Director, Tariffs

EFFECTIVE:
September 30, 2004

GENERAL EXCHANGE TARIFF

UNITED TELEPHONE COMPANY
OF THE WEST
NEBRASKA

Section 19
First Revised Sheet 28
Cancels Original Sheet 28

N11 SERVICE

(T)

D. 211 Service for Information and Referral Service (Cont'd)

2. Obligations of the Approved Information and Referral Service Provider (Cont'd)

- k) The Approved Information and Referral Service Provider shall not promote the 211 Service with the use of an autodialer or broadcasting of tones that dial the 211 abbreviated dialing code.
- l) The 211 Service is only available to end users located in Company local exchanges. To establish 211 calling to end users in non-Company local exchanges, the Approved Information and Referral Service Provider must make appropriate arrangements with the companies serving those local exchanges, even where Company subscribers may make local calls to the non-Company local exchanges.
- m) The Approved Information and Referral Service Provider must work separately with competitive local exchange carriers operating and serving customers in the Company's local exchanges to ascertain whether 211 abbreviated dialing will be available to their end users.

3. Obligations of the Company

- a) The Company will establish the 211 Service within ninety days after receipt of the Approved Information and Referral Service Provider's completed application(s) for service or the effective date of this tariff, whichever is later.
- b) When a 211 Service call is placed by the calling party via interconnection with an interexchange carrier, the Company cannot guarantee the completion of said 211 Service call, the quality of the call or any features that may otherwise be provided with 211 Service.
- c) The Company does not undertake to answer and forward 211 Service calls but furnishes the use of its facilities to enable the Approved Information and Referral Service Provider to respond to such calls at the Approved Information and Referral Service Provider established call centers.
- d) The rates charged for 211 Service do not contemplate the inspection or constant monitoring of facilities to discover errors, defects, and malfunctions in service, nor does the Company undertake such responsibility. The Approved Information and Referral Service Provider shall make such operational tests as, in the judgment of the Approved Information and Referral Service Provider, are required to determine whether the Company's facilities are functioning properly for its use. The Approved Information and Referral Service Provider shall promptly notify the Company in the event the Company's facilities are not functioning properly.



ISSUED:
September 20, 2004

BY: Warren D. Hannah
Director, Tariffs

EFFECTIVE:
September 30, 2004

GENERAL EXCHANGE TARIFF

UNITED TELEPHONE COMPANY
OF THE WEST
NEBRASKA

Section 19
First Revised Sheet 29
Cancels Original Sheet 29

N11 SERVICE

(T)

D. 211 Service for Information and Referral Service (Cont'd)

4. Liability

- a) The liability of the Company for losses or damages of any kind arising out of mistakes, omissions, interruptions, delays, errors or defects in transmission, or failure or defects in any facility furnished by the Company, occurring in the course of furnishing 211 Service, or of the Company in failing to maintain proper standards of maintenance and operation or to exercise reasonable supervision, shall in no event exceed an amount equivalent to the proportionate charge to the Approved Information and Referral Service Provider for the 211 Service and local exchange services for the period of service during which such mistake, omission, interruption, delay, error or defect in transmission or defect or failure in facilities occurs.
- b) The Company is not liable for losses or damages caused by the negligence of the Approved Information and Referral Service Provider.
- c) The Company's entire liability to any person for interruption or failure of the 211 Service is limited to the terms set forth in this section and other sections of this Tariff.

5. Other Terms and Conditions

- a) The 211 Service will not provide calling number information in real time to the Approved Information and Referral Service Provider. If this type of information is required, the Approved Information and Referral Service Provider must subscribe to compatible Caller ID service as described in Section 12 of the Price List. The Caller ID service will only provide calling number information as described in Section 12 of the Price List.
- b) The 211 Service is provided for the benefit of the Approved Information and Referral Service Provider. The provision of the 211 Service by the Company shall not be interpreted, constructed or regarded, either expressly or implied, as being for the benefit of or creating any Company obligation toward any third person or legal entity other than the Approved Information and Referral Service Provider.



ISSUED:
September 20, 2004

BY: Warren D. Hannah
Director, Tariffs

EFFECTIVE:
September 30, 2004

GENERAL EXCHANGE TARIFF

UNITED TELEPHONE COMPANY
OF THE WEST
NEBRASKA

Section 19
First Revised Sheet 30
Cancels Original Sheet 30

N11 SERVICE

(T)

D. 211 Service for Information and Referral Service (Cont'd)

5. Other Terms and Conditions (Cont'd)

- c) A written notice will be sent to the Approved Information and Referral Service Provider following oral notification when its 211 Service unreasonably interferes with or impairs other services rendered to the public by the Company or by other subscribers of abbreviated dialing codes. If after notification the Approved Information and Referral Service Provider makes no modification in method of operation or in the service arrangements that are deemed service-protective by the Company, or if the Approved Information and Referral Service Provider is unwilling to accept the modifications, or if the Approved Information and Referral Service Provider continues to cause service impairment, the Company reserves the right, at any time, without further notice, to institute protective measures, up to and including termination of service.
- d) In an emergency situation as determined by the Company, the Company reserves the right, at any time, without notice, to institute protective measures, up to and including termination of service.

6. Rates and Charges

- a) Subject to other terms and conditions of this Tariff, Company subscribers shall be able to make and the Approved Information and Referral Service Provider shall be able to receive calls using the 211 Service as part of both parties' local exchange service. The 211 Service is supplemental to and is not a replacement for either party's local exchange service.
- b) A nonrecurring Central Office Charge applies for each Company host central office out of which 211 Service is established, as follows:
 - 1. When a Company local exchange is served by more than one host central office a Central Office Charge is applicable for each host central office in the Company local exchange.
 - 2. If the Approved Information and Referral Service Provider establishes 211 Service in multiple Company local exchanges served by the same host central office, only one Central Office Charge shall apply. However, the full Central Office Charge applies whether or not the Approved Information and Referral Service Provider requests 211 Service in all the Company local exchanges served by that host central office.



ISSUED:
September 20, 2004

BY: Warren D. Hannah
Director, Tariffs

EFFECTIVE:
September 30, 2004

GENERAL EXCHANGE TARIFF

UNITED TELEPHONE COMPANY
OF THE WEST
NEBRASKA

N11 SERVICE



D. 211 Service for Information and Referral Service (Cont'd)

6. Rates and Charges (Cont'd)

- c) An Exclusion Charge Applies for the establishment of 211 Service as follows:
 - 1. When the Approved Information and Referral Service Provider does not simultaneously establish 211 Service in every Company local exchange served by a host central office, the Approved Information and Referral Service Provider shall pay an Exclusion Charge for each Company local exchange served by the host central office where 211 Service is not established.
 - 2. When a Company local exchange is once excluded, but the Approved Information and Referral Service Provider later applies to establish 211 Service in the Company local exchange, an Exclusion Charge again applies for each local exchange that continues to be excluded.
 - 3. When the Approved Information and Referral Service Provider requests a different telephone number be translated to the 211 abbreviated dialing code in a participating central office than the telephone number translated to the 211 abbreviated dialing code in the host central office.
- d) A nonrecurring Number Change Charge applies when the Approved Information and Referral Service Provider changes the telephone number into which the 211 abbreviated dialing code is translated. The Number Change Charge is applied on a per telephone number, per host central office basis.
- e) When translating the seven or ten digit number to the 211 abbreviated dialing code, applicable Service Connection Charges as specified in Section 18 of this tariff will apply as follows, in addition to the rates listed below.
 - 1. A business rate Change or Record Order Charge per order, as found in Section 18 of this tariff.

f) Rates

	<u>Nonrecurring Charge</u>
1. Central Office Charge (per host Central Office)	\$ 175.00
2. Exclusion Charge (per Exchange)	325.00
3. Number Change Charge (per telephone number)	35.00

ISSUED:
September 20, 2004

BY: Warren D. Hannah
Director, Tariffs

EFFECTIVE:
September 30, 2004

GENERAL EXCHANGE TARIFF

UNITED TELEPHONE COMPANY
OF THE WEST
NEBRASKA

Section 19
First Revised Sheet 32
Cancels Original Sheet 32

N11 SERVICE

(T)

E. 511 Service for Travel Information Services

1. General

- a) 511 Dialing Code ("511") is a three digit local dialing arrangement for telephone voice transmission access to all certified Travel Information Service entities as a toll free call. The Federal Communications Commission (FCC) assigned *the* 511 dialing code for nationwide access to Travel Information Services. (T)
- b) The three digit 511 abbreviated dialing code is assigned to the Approved Travel Information Service Provider ("511 Provider") for use in providing community Travel Information services to the public by way of voice grade facilities.
- c) 511 is available from United Telephone Company of the West **Nebraska** within the Company's service area only. To provide access to 511 to end users in another company service area or to a Competitive Local Exchange Carrier (CLEC) end users within the local calling area, the 511 Provider must make appropriate arrangements with the other company or CLEC serving that territory. The 511 Provider should work separately with competing local providers to ascertain that its end user customers will be able to reach relay services provided by dialing 511. (T)
- d) All 511 abbreviated dialing code calls must be local in nature and will not result in any intraLATA toll, interLATA long distance or pay-per-call charges to Company subscribers. However, 511 Service calls may result in measured service charges where Company subscribers' service plans include such charges as part of local measured service or home exchange service calling plans.
- e) The 511 Service is not available for the following classes of service: inmate service, 1+ and 0+ calling, 0- operator assisted calling and 101XXXX calling. 511 Service is otherwise available wherever local service is accessible.
- f) **511 Service is offered subject to the availability of facilities.** (N)



ISSUED:
September 20, 2004

BY: Warren D. Hannah
Director, Tariffs

EFFECTIVE:
September 30, 2004

GENERAL EXCHANGE TARIFF

UNITED TELEPHONE COMPANY
OF THE WEST
NEBRASKA

Section 19
First Revised Sheet 33
Cancels Original Sheet 33

N11 SERVICE

(T)

E. 511 Service for Travel Information Services (Cont'd)

2. Obligations of the Approved Travel Information Services Provider

- a) The 511 Provider must submit a written application to the Company for 511 Service at the local exchange level. The 511 Provider may establish 511 Service in all or part of the Company's local exchanges. There may be only one 511 Provider per exchange.
- b) The 511 Provider's written application to establish 511 Service in a Company local exchange must include the following:
 1. The local, foreign exchange or toll free telephone number into which the Company should translate the dialed 511 abbreviated code. If the 511 Provider desires to change the telephone number into which the 511 abbreviated dialing code is translated, the 511 Provider must pay a Number Change Charge as found in Section 19.E.6.f.
 2. A location description of the 511 Provider call center where 511 calls made from the Company local exchange will be routed.
 3. For network sizing and protection, an estimate of annual call volumes and holding time for calls to the 511 Service.
 4. An acknowledgment of the possibility that the Commission's assignment of the 511 abbreviated dialing code may be recalled at any time.
- c) Local Calling for Company Subscribers
 1. The 511 Provider, in cooperation with the Company, will assure that all 511 Service calls are local and do not generate intraLATA toll, interLATA long distance or pay-per-call charges for Company subscribers.
 2. When the 511 Provider applies for 511 Service in a Company local exchange, the 511 Provider must supply the Company with a seven or ten digit telephone number that terminates within the Company local exchange's local calling area. The Company will translate the 511 digits into the telephone number provided by the 511 Provider.
 3. When the 511 Provider applies for 511 Service in a Company local exchange and a 511 Provider call center is not located within the local exchange's local calling area, the 511 Provider must establish foreign exchange service or supply the Company with a toll free telephone number so that Company subscribers' 511 Service calls do not incur toll charges.



ISSUED:
September 20, 2004

BY: Warren D. Hannah
Director, Tariffs

EFFECTIVE:
September 30, 2004

GENERAL EXCHANGE TARIFF

UNITED TELEPHONE COMPANY
OF THE WEST
NEBRASKA

Section 19
First Revised Sheet 34
Cancels Original Sheet 34

N11 SERVICE

(T)

E. 511 Service for Travel Information Services (Cont'd)

2. Obligations of the Approved Travel Information Services Provider (Cont'd)

- d) The 511 Provider is liable for and will indemnify, protect, defend and hold harmless the Company against all suits, actions, claims, demands and judgments, plus any expenses and counsel fees incurred by the Company on account thereof, whether suffered, made, instituted or asserted by the 511 Provider or any other party or person, for any personal injury to or death of any person or persons, or for any loss, damage or destruction of any property, whether owned by the 511 Provider or others, arising out of or resulting directly or indirectly from the 511 Service.
- e) The 511 Provider must develop an appropriate method for responding to 511 calls directed to it out of confusion or in error by Company subscribers.
- f) The 511 Provider must subscribe to termination facilities and lines in sufficient quantities to provide adequate service to the public, and enable the 511 Provider to receive calls to the 511 Service during normal business hours.
- g) The 511 Service is provided on the condition that the 511 Provider subscribes to termination facilities and lines in sufficient quantities to adequately handle calls to the 511 Service without interfering with or impairing any services offered by the Company. There will be one path available for each line to which the 511 Provider subscribes.
- h) The 511 Provider must comply with all present and future state and federal rules pertaining to abbreviated dialing codes, **including any and all requirements to relinquish the 511 abbreviated dialing code in the event of a national assignment contrary to that made by the Nebraska Public Service Commission.**
- i) The 511 Provider is responsible for obtaining all necessary permissions, licenses, written consents, waivers and releases and all other rights from all persons whose work, statements or performances are used in connection with the 511 Service. The 511 Provider is also responsible for obtaining all necessary permissions, licenses, written consents, waivers and releases and all other rights from all holders of copyrights, trademarks and patents used in connection with the said service.
- j) The 511 Provider must respond promptly to all complaints lodged with any regulatory authority against the 511 Service. If requested by the Company, the 511 Provider must assist the Company in responding to complaints made to the Company concerning the 511 Service.
- k) The 511 Provider shall not promote the 511 Service with the use of an autodialer or broadcasting of tones that dial the 511 abbreviated dialing code.

(N)
|
(N)

(T)



ISSUED:
September 20, 2004

BY: Warren D. Hannah
Director, Tariffs

EFFECTIVE:
September 30, 2004

GENERAL EXCHANGE TARIFF

UNITED TELEPHONE COMPANY
OF THE WEST
NEBRASKA

Section 19
First Revised Sheet 35
Cancels Original Sheet 35

N11 SERVICE

(T)

E. 511 Service for Travel Information Services (Cont'd)

2. Obligations of the Approved Travel Information Services Provider (Cont'd)

- l) The 511 Service is available only to end users located in Company local exchanges. To establish 511 calling to end users in non-Company local exchanges, the 511 Provider must make appropriate arrangements with the companies serving those local exchanges, even where Company subscribers may make local calls to the non-Company local exchanges.
- m) The 511 Provider must work separately with competitive local exchange carriers ("CLECs") operating and serving customers in the Company's local exchanges to ascertain whether 511 abbreviated dialing will be available to their end users.

3. Obligations of the Company

- a) The Company will establish the 511 Service within ninety days after receipt of the 511 Provider's completed application(s) for service or the effective date of this tariff, whichever is later.
- b) When a 511 Service call is placed by the calling party via interconnection with an interexchange carrier, the Company cannot guarantee the completion of said 511 Service call, the quality of the call or any features that may otherwise be provided with 511 Service.
- c) The Company will route 511 calls originating from end users on the Company's local exchange network whether they purchase service directly from the Company or from another provider reselling Company service. Otherwise, the Company is not responsible for establishing 511 Service for calls originating from other telecommunications providers.
- d) The Company does not undertake to answer and forward 511 Service calls but furnishes the use of its facilities to enable the 511 Provider to respond to such calls at the 511 Provider established call centers.
- e) The rates charged for 511 Service do not contemplate the inspection or constant monitoring of facilities to discover errors, defects, and malfunctions in service, nor does the Company undertake such responsibility. The 511 Provider must conduct such operational tests as, in the judgment of the 511 Provider, are required to determine whether the Company's facilities are functioning properly for its use. The 511 Provider must promptly notify the Company in the event the Company's facilities are not functioning properly.



ISSUED:
September 20, 2004

BY: Warren D. Hannah
Director, Tariffs

EFFECTIVE:
September 30, 2004

GENERAL EXCHANGE TARIFF

UNITED TELEPHONE COMPANY
OF THE WEST
NEBRASKA

Section 19
First Revised Sheet 36
Cancels Original Sheet 36

N11 SERVICE

(T)

E. 511 Service for Travel Information Services (Cont'd)

4. Liability

- a) The liability of the Company for losses or damages of any kind arising out of mistakes, omissions, interruptions, delays, errors or defects in transmission, or failure or defects in any facility furnished by the Company, occurring in the course of furnishing 511 Service, or of the Company in failing to maintain proper standards of maintenance and operation or to exercise reasonable supervision, shall in no event exceed an amount equivalent to the proportionate charge to the 511 Provider for the 511 Service and local exchange services for the period of service during which such mistake, omission, interruption, delay, error or defect in transmission or defect or failure in facilities occurs.
- b) The Company is not liable for any losses or damages caused by the negligence of the 511 Provider.
- c) The Company's entire liability to any person for interruption or failure of the 511 Service is limited to the terms set forth in this and other sections of this Tariff.
- d) The Commission's local assignment and the 511 Service Provider's use of the 511 abbreviated dialing code is subject to preemption by the Federal Communications Commission. The Company shall not be liable to the 511 Service Provider for any damages the 511 Service Provider may incur that results from a national assignment of the 511 abbreviated dialing code.
- e) The Company will make every effort to route 511 calls to the appropriate 511 Service Provider calling center, however, the Company will not be held responsible for routing mistakes or errors.



ISSUED:
September 20, 2004

BY: Warren D. Hannah
Director, Tariffs

EFFECTIVE:
September 30, 2004

GENERAL EXCHANGE TARIFF

UNITED TELEPHONE COMPANY
OF THE WEST
NEBRASKA

Section 19
First Revised Sheet 37
Cancels Original Sheet 37

N11 SERVICE

(T)

E. 511 Service for Travel Information Services (Cont'd)

5. Other Terms and Conditions

- a) The 511 Service will not provide calling number information in real time to the 511 Provider. If this type of information is required, the 511 Provider must subscribe to compatible Caller ID service as described in Section 12 of the Price List. The Caller ID service will only provide calling number information as described in Section 12 of the Price List.
- b) The 511 Service is provided for the benefit of the 511 Provider. The provision of the 511 Service by the Company shall not be interpreted, constructed or regarded, either expressly or implied, as being for the benefit of or creating any Company obligation toward any third person or legal entity other than the 511 Provider.
- c) A written notice will be sent to the 511 Provider following oral notification when its 511 Service unreasonably interferes with or impairs other services rendered to the public by the Company or by other subscribers of abbreviated dialing codes. If after notification the 511 Provider makes no modification in method of operation or in the service arrangements that are deemed service-protective by the Company, or if the 511 Provider is unwilling to accept the modifications, or if the 511 Provider continues to cause service impairment, the Company reserves the right, at any time, without further notice, to institute protective measures, up to and including termination of service.
- d) In an emergency situation as determined by the Company, the Company reserves the right, at any time, without notice, to institute protective measures, up to and including termination of service.



ISSUED:
September 20, 2004

BY: Warren D. Hannah
Director, Tariffs

EFFECTIVE:
September 30, 2004

GENERAL EXCHANGE TARIFF

UNITED TELEPHONE COMPANY
OF THE WEST
NEBRASKA

Section 19
First Revised Sheet 38
Cancels Original Sheet 38

N11 SERVICE

(T)

E. 511 Service for Travel Information Services (Cont'd)

6. Rates and Charges

a) A Central Office Charge applies for each Company host central office out of which the 511 Provider orders 511 Service, as follows:

- 1. When a Company local exchange is served by more than one host central office, a Central Office Charge is applicable for each host central office in that local exchange.
- 2. If the 511 Provider establishes 511 Service in multiple Company local exchanges served by the same host central office, only one Central Office Charge applies. However, the full Central Office Charge applies whether or not the 511 Provider requests 511 Service in all the Company local exchanges served by that host central office.

b) An Exclusion Charge applies *in lieu of a Central Office Charge* for the establishment of 511 Service as follows:

(T)

- 1. When the 511 Provider does not make simultaneous applications to establish 511 Service in every Company local exchange served by a host central office, the 511 Provider must pay an Exclusion Charge *per* host central office **if any local exchange(s) are excluded from the translation.**
- 2. When a Company local exchange is once excluded, but the 511 Provider later makes application to establish 511 Service in the Company local exchange, then an Exclusion Charge applies *per host central office when a local exchange continues to be excluded from the translation.*
- 3. When the 511 Provider requests a different telephone number be translated to the 511 abbreviated dialing code in a participating **Company local exchange other** than the telephone number translated to the 511 abbreviated dialing code in the host central office, **then an Exclusion Charge applies per host central office.**

(T)
(T)

(T)
(T)

(T)
|
(T)

c) A Number Change Charge applies when the 511 Provider established service or applies to change the telephone number into which the 511 abbreviated dialing code is translated. The Number Change Charge is applied on a per telephone number, per host central office basis.



GENERAL EXCHANGE TARIFF

UNITED TELEPHONE COMPANY
OF THE WEST
NEBRASKA

Section 19
First Revised Sheet 39
Cancels Original Sheet 39

N11 SERVICE

(T)

E. 511 Service for Travel Information Services (Cont'd)

6. Rates and Charges (Cont'd)

d) When translating the seven or ten digit number to the 511 abbreviated dialing code, applicable Service **Connection** Charges as specified in Section 18 of this tariff will apply as follows, in addition to the rates listed in Section 19.E.6.f. below. (T)

1. **A simple business rate Record Order Charge per order, as found in Section 18 of this tariff.** (N)
(N)

e) The minimum service period for 511 Service is one month.

f) Rates:

	<u>Nonrecurring Charge</u>	
1. Central Office Charge (per host Central Office)	\$175.00	
2. Exclusion Charge (per host Central Office)	325.00	(T)
3. Number Change Charge (per telephone number)	35.00	



ISSUED:
September 20, 2004

BY: Warren D. Hannah
Director, Tariffs

EFFECTIVE:
September 30, 2004

GENERAL EXCHANGE TARIFF

UNITED TELEPHONE COMPANY
OF THE WEST
NEBRASKA

Section 19
Original Sheet 40

N11 SERVICES

F. 811 Service For "One Call" Notification Systems ⁽¹⁾

1. General

- a) 811 Dialing Code ("811 Service") is a three digit local dialing arrangement for telephone voice transmission access to all certified "One Call" notification systems entities as a toll free call. The Federal Communications Commission (FCC) assigned 811 dialing code for nationwide access to One Call Notification Systems.
- b) The three digit 811 abbreviated dialing One Call Notification code is assigned to the Approved "811 Provider" for use in providing One Call notification services to the public by way of voice grade facilities.
- c) 811 Service is available from United Telephone Company of The West - Nebraska (the Company) within the Company's service area only. To provide access to 811 to end users in another company's service area or to Competitive Local Exchange Carrier (CLEC) end users within the local calling area, the 811 Provider must make appropriate arrangements with the other company or CLEC serving that territory. The 811 Provider should work separately with competing local providers to ascertain that its end user customers will be able to reach one-call services provided by dialing 811.
- d) All 811 abbreviated dialing code calls must be local in nature and will not result in any intraLATA toll, interLATA long distance or pay-per-call charges to Company subscribers. However, 811 Service calls may result in local measured service charges where Company subscribers' service plans include such charges.
- e) The 811 Service is not available for the following classes of service: inmate service, 1+ and 0+ calling, 0- operator assisted calling and 101XXXX calling. 811 Service is otherwise available wherever local service is accessible.

(1) This service will be available no later than April, 2007 per FCC mandate.

ISSUED:
March 23, 2007

BY: Darlene Terry
Manager, Tariffs

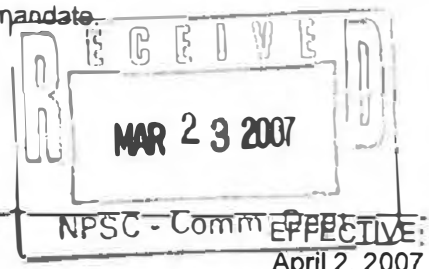

April 2, 2007

GENERAL EXCHANGE TARIFF

UNITED TELEPHONE COMPANY
OF THE WEST
NEBRASKA

Section 19
Original Sheet 41

N11 SERVICES

F. 811 Service For "One Call" Notification Systems (Cont'd)

2. Obligations of the Approved "One Call" Notification Systems Provider

- a) The 811 Provider must submit a written application to the Company for 811 Service at the state level. The 811 Provider may establish 811 Service in all or part of the Company's exchanges. There may be only one 811 Provider per exchange.
- b) The 811 Provider's written application to establish 811 Service in a Company local exchange must include the following:
 1. The local, foreign exchange or toll free telephone number into which the Company should translate the dialed 811 abbreviated code. If the 811 Provider desires to change the telephone number into which the 811 abbreviated dialing code is translated, the 811 Provider must pay a Number Change Charge as found in Section F.6.d).
 2. For network sizing and protection, an estimate of annual call volumes and holding time for calls to the 811 Service.
 3. An acknowledgment of the possibility that the Commission's assignment of the 811 abbreviated dialing code may be recalled at any time.
- c) Local Calling for Company Subscribers
 1. The 811 Provider, in cooperation with the Company, will assure that all 811 Service calls are local and do not generate intraLATA toll, interLATA long distance or pay-per-call charges for Company subscribers.
 2. When the 811 Provider applies for 811 Service from the Company, the 811 Provider must supply the Company with a toll free number. The Company will translate the 811 digits into the telephone number provided by the 811 Provider.
- d) The 811 Provider is liable for and will indemnify, protect, defend and hold harmless the Company against all suits, actions, claims, demands and judgments, plus any expenses and counsel fees incurred by the Company on account thereof, whether suffered, made, instituted or asserted by the 811 Provider or any other party or person, for any personal injury to or death of any person or persons, or for any loss, damage or destruction of any property, whether owned by the 811 Provider or others, arising out of or resulting directly or indirectly from the 811 Service.
- e) The 811 Provider must develop an appropriate method for responding to 811 calls directed to it out of confusion or in error by Company subscribers.

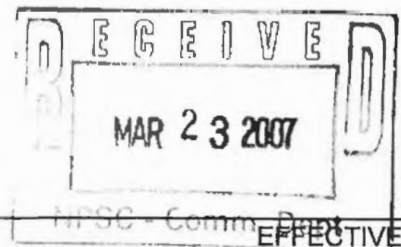

ISSUED:
March 23, 2007

BY: Darlene Terry
Manager, Tariffs

EFFECTIVE:
April 2, 2007

GENERAL EXCHANGE TARIFF

UNITED TELEPHONE COMPANY
OF THE WEST
NEBRASKA

Section 19
Original Sheet 43

N11 SERVICES

F. 811 Service For "One Call" Notification Systems (Cont'd)

3. Obligations of the Company

- a) The Company will establish the 811 Service within ninety days after receipt of the 811 Provider's completed application(s) for service or the effective date of this Tariff, whichever is later.
- b) When an 811 Service call is placed by the calling party via interconnection with an interexchange carrier, the Company cannot guarantee the completion of said 811 Service call, the quality of the call or any features that may otherwise be provided with 811 Service.
- c) The Company will route 811 calls originating from end users on the Company's local exchange network whether they purchase service directly from the Company or from another provider reselling company service. Otherwise, the Company is not responsible for establishing 811 Service for calls originating from other telecommunications providers.
- d) The Company does not undertake to answer and forward 811 Service calls but furnishes the use of its facilities to enable the 811 Provider to respond to such calls at the 811 Provider established call centers.
- e) The rates charged for 811 Service do not contemplate the inspection or constant monitoring of facilities to discover errors, defects, and malfunctions in service, nor does the Company undertake such responsibility. The 811 Provider must conduct such operational tests as, in the judgment of the 811 Provider, are required to determine whether the Company's facilities are functioning properly for its use. The 811 Provider must promptly notify the Company in the event the Company's facilities are not functioning properly.

4. Liability

- a) The liability of the Company for losses or damages of any kind arising out of mistakes, omissions, interruptions, delays, errors or defects in transmission, or failure or defects in any facility furnished by the Company, occurring in the course of furnishing 811 Service, or of the Company in failing to maintain proper standards of maintenance and operation or to exercise reasonable supervision, shall in no event exceed an amount equivalent to the proportionate charge to the 811 Provider for the 811 Service and local exchange services for the period of service during which such mistake, omission, interruption, delay, error or defect in transmission or defect or failure in facilities occurs.

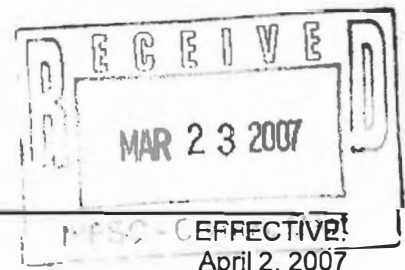

ISSUED:
March 23, 2007

BY: Darlene Terry
Manager, Tariffs

April 2, 2007

GENERAL EXCHANGE TARIFF

UNITED TELEPHONE COMPANY
OF THE WEST
NEBRASKA

Section 19
Original Sheet 44

N11 SERVICES

F. 811 Service For "One Call" Notification Systems (Cont'd)

4. Liability (Cont'd)

- b) The Company is not liable for any losses or damages caused by the negligence of the 811 Provider.
- c) The Company's entire liability to any person for interruption or failure of the 811 Service is limited to the terms set forth in this and other sections of this Tariff.
- d) The Commission's local assignment and the 811 Service Provider's use of the 811 abbreviated dialing code are subject to preemption by the Federal Communications Commission. The Company shall not be liable to the 811 Service Provider for any damages the 811 Service Provider may incur that results from a national assignment of the 811 abbreviated dialing code.
- e) The Company will make every effort to route 811 calls to the appropriate 811 Service Provider calling center, however, the Company will not be held responsible for routing mistakes or errors.

5. Other Terms and Conditions

- a) The 811 Service will not provide calling number information in real time to the 811 Provider. If this type of information is required, the 811 Provider must subscribe to compatible Caller ID service as described in Section 12 of the General Exchange Price List. The Caller ID service will only provide calling number or name and number information as described in Section 12 of the General Exchange Price List.
- b) The 811 Service is provided for the benefit of the 811 Provider. The provision of the 811 Service by the Company shall not be interpreted, constructed or regarded, either expressly or implied, as being for the benefit of or creating any Company obligation toward any third person or legal entity other than the 811 Provider.
- c) A written notice will be sent to the 811 Provider following oral notification when its 811 Service unreasonably interferes with or impairs other services rendered to the public by the Company or by other subscribers of abbreviated dialing codes. If after notification the 811 Provider makes no modification in method of operation or in the service arrangements that are deemed service-protective by the Company, or if the 811 Provider is unwilling to accept the modifications, or if the 811 Provider continues to cause service impairment, the Company reserves the right, at any time, without further notice, to institute protective measures, up to and including termination of service.
- d) In an emergency situation as determined by the Company, the Company reserves the right, at any time, without notice, to institute protective measures, up to and including termination of service.

MAR 23 2007

ISSUED:
March 23, 2007

BY: Darlene Terry
Manager, Tariffs

EFFECTIVE:
April 2, 2007

GENERAL EXCHANGE TARIFF

UNITED TELEPHONE COMPANY
OF THE WEST
NEBRASKA

Section 19
Original Sheet 45

N11 SERVICES

F. 811 Service For "One Call" Notification Systems (Cont'd)

6. Rates and Charges

- a) A Central Office Charge applies for each Company host central office out of which the 811 Provider orders 811 Service, as follows:
 - 1. When a Company exchange is served by more than one host central office, a Central Office Charge is applicable for each host central office in that exchange.
 - 2. If the 811 Provider establishes 811 Service in multiple Company exchanges served by the same host central office, only one Central Office Charge applies.
- b) A Number Change Charge applies when the 811 Provider established service or applies to change the telephone number into which the 811 abbreviated dialing code is translated. The Number Change Charge is applied on a per telephone number, per host central office basis.
- c) When translating the seven or ten digit number to the 811 abbreviated dialing code, applicable Service Connection Charges as specified in Section 18 of this Tariff will apply in addition to the rates listed below.

d) Rates:

	<u>Nonrecurring Charge</u>
Central Office Charge ⁽¹⁾	\$0.00
Number Change Charge (per Telephone Number)	0.00

⁽¹⁾ This is applied at the host central office only, and covers all offices that are part of that host complex with a single translated number. If more than one translated number is desired, apply the charge as many times as there are numbers. Any given office must have one number translated to – this cost does not cover cases where the Local Agency wants two or more translated numbers. Such a case would require class marking or a database.

MAR 23 2007

ISSUED: March 23, 2007	EFFECTIVE: NFSC - Comrap 2p 2007
---------------------------	-------------------------------------

BY: Darlene Terry
Manager, Tariffs

GENERAL EXCHANGE TARIFF

UNITED TELEPHONE COMPANY
OF THE WEST d/b/a CenturyLink
NEBRASKA

Section 20
Third Revised Sheet 1 (C)
Cancels Second Revised Sheet 1

SUSPENSION OF SERVICE

A. SUSPENSION OF SERVICE FOR NON-PAYMENT OF CHARGES OR FOR OTHER VIOLATIONS OF REGULATIONS

1. The service furnished a subscriber may be temporarily suspended for non-payment of charges due or for other violations of the regulations of the telephone company, as described under "General Rules and Regulations Referring to Telephone Service," and, if suspended, the service may be restored as outlined under "Restoration of Service."

a. Lifeline subscribers will not be disconnected for non-payment of toll charges.

B. SUSPENSION OF SERVICE AT REQUEST OF SUBSCRIBERS

Any class of exchange service may be temporarily suspended, at the request of the subscriber, as provided hereinafter:

1. A suspension rate will be applicable throughout the period of suspension, except as specified in a. and b. as follows:

a. Where the initial contract period is one month or longer, the suspension rate will not be applicable until after the service has been in effect at full rate for at least one month. Where the initial contract period is in excess of one month, the contract period will be extended by one-half of the period service is on suspension.

b. Where service has been restored to the full rate following a period of suspension, the suspension rate will not be applicable in connection with a subsequent suspension until one month has elapsed since the effective date of the restoral to the full rate service. The maximum period of suspension is **nine (9)** months in any calendar year. (C)

2. If service is disconnected while on suspension and before, the minimum period (one month in connection with suspension of all service, two months in connection with suspension of portion of service) has elapsed, the subscriber will be charged for the minimum period at the suspension rate or charged for the actual number of days of service at the full rate whichever produces the lower charge. (D)

3. In connection with suspension of all service, the suspension rate will not be applicable unless service is retained on suspension for one month or more. (M)(T)

4. The reduction in rate for the period of suspension is equal to 50 percent of the access line charge and EAS charges if applicable. (T)

5. No outward or inward service is given during the period of suspension. (M)(T)

(M) Material now appearing on this page was previously found on Third Revised Sheet 2.

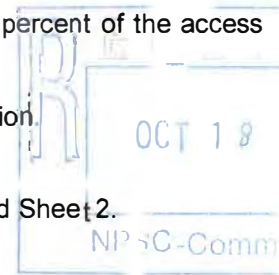

ISSUED:
October 18, 2011

BY: Darlene Terry
Manager, Tariffs

EFFECTIVE:
October 28, 2011

GENERAL EXCHANGE TARIFF

UNITED TELEPHONE COMPANY
OF THE WEST d/b/a CenturyLink
NEBRASKA

Section 20
Fourth Revised Sheet 2
Cancels Third Revised Sheet 2

(C)

SUSPENSION OF SERVICE

(D)

(M)

(M)

C. SUSPENSION OF ENTIRE SERVICE

1. Simple Exchange Service

- a. Complete temporary suspension of service is available to subscribers of business or residence individual line service. Suspension of the entire service of a subscriber is intended to meet the needs of those subscribers who desire to discontinue their telephone service temporarily because they, and those whose use of the service is contemplated under the subscriber's application of service, are to be absent from the premises, but who wish to retain their directory listings and have the other benefits of suspension. The "Record Order" service connection charge will be applied when service is restored.
- b. If the computed rate is two and one-half cents more than a multiple of five cents, the next higher multiple is the rate to be charged.

2. Multi-line and Private Branch Exchange Service

- a. Complete or partial temporary suspension of service with reduction in charges is permitted for any period of one month or more. The reduced rate is applicable only to the access line charges. The "Record Order" service connection charge will be applied when service is restored.
- b. If the computed rate is two and one-half cents more than a multiple of five cents, the next higher multiple is the rate to be charged.

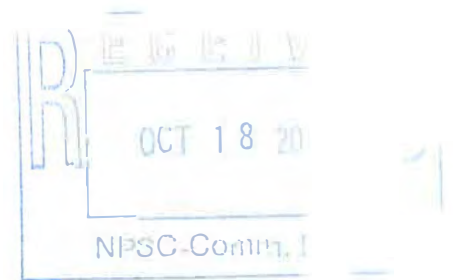

(M) Material previously found on this page now appears on Third Revised Sheet 1 of this section.

ISSUED:
October 18, 2011

BY: Darlene Terry
Manager, Tariffs

EFFECTIVE:
October 28, 2011

GENERAL EXCHANGE TARIFF

UNITED TELEPHONE COMPANY
OF THE WEST
NEBRASKA

Section 20
Original Sheet 3

SUSPENSION OF SERVICE

D. SUSPENSION OF PORTION OF SERVICE

1. Suspension of a portion of service is intended to meet the needs of those multi-line subscribers who desire to have a portion of their access lines suspended but who wish to retain the remainder of their access lines on a non-suspended basis. The "Record Order" service connection charge will be applied when service is restored.
2. In connection with suspension of a portion of service, the suspension rate will not be applicable unless the service or facility is retained on suspension for two months or more.

(L)

(T)

(L)

ISSUED: July 15, 1986

BY: I. B. Watson
Vice President - Administration
6666 West 110th Street
Overland Park, Kansas 66211

EFFECTIVE: August 1, 1986
Docket No. C-574

GENERAL EXCHANGE TARIFF

UNITED TELEPHONE COMPANY
OF THE WEST
NEBRASKA

Section 21
First Revised Sheet 1
Canceling Original Sheet 1

PUBLIC EMERGENCY REPORTING SERVICE

A. GENERAL

In the interest of public safety, the telephone company will make available to municipalities telephone channels and facilities for an emergency reporting service which will permit direct conversation between a person reporting the emergency and a telephone generally located at fire and/or police headquarters.

B. REGULATIONS

1. Public Emergency Reporting Services (Group alerting and dispatching systems) are furnished subject to the following conditions and regulations: (T)
 - a. The group alerting and dispatching system is supplied only for the benefit of the customer, and no other person shall derive any rights from the furnishing of the group alerting and dispatching system by the Telephone Company. When the group alerting and dispatching is furnished to a corporation, city, town or municipality, as legal entity or governmental body, shall be deemed to be a customer and service furnished to any legal entity or governmental body shall not be interpreted, construed or regarded as being for the benefit of, or creating any contractual rights in or duty toward any individuals connected with such corporation, or any individual resident of any city, town or municipality. Any benefit derived from the use of the group alerting and dispatching system by persons other than the customer is to be considered as incidental.
 - b. The rates charged for the group alerting and dispatching system do not contemplate constant monitoring by the Telephone Company to discover operating defects and malfunctions. The customer shall have the responsibility of discovering such operating defects and malfunctions, and assumes the duty of and will make such tests as are in the judgement of the customer required to determine whether the system is functioning properly. The customer shall forthwith notify the Telephone Company whenever the system is not functioning properly.
 - c. The Telephone Company shall not be liable for any loss or damages arising out of interruptions, defects, failure or malfunctions of the group alerting and dispatching system which occur during the operations of the system until after it has been duly notified by the customer that the system is not functioning properly and the Telephone Company has had a reasonable time thereafter to correct (T)

ISSUED: July 15, 1986

EFFECTIVE: August 1, 1986
Docket No. C-574

BY: I. B. Watson
Vice President - Administration
6666 West 110th Street
Overland Park, Kansas 66211

GENERAL EXCHANGE TARIFF

UNITED TELEPHONE COMPANY OF THE WEST
d/b/a CENTURYLINK
NEBRASKA

Section 21
Fourth Revised Sheet 2
Cancels Third Revised Sheet 2

PUBLIC EMERGENCY REPORTING SERVICE (Cont'd)

B. REGULATIONS (Cont'd)

1. (Cont'd)

c. (Cont'd)

such defect or malfunction. Damages arising out of interruptions, defects, failures or malfunctions of the system after the Telephone Company has been so notified and has had a reasonable time to correct the same, shall in no event exceed an amount equivalent to the charges made for the system for the period following notice from the customer until service is restored. The customer indemnifies the Telephone Company against all loss or damage to persons or property occurring from the use, attempted use or failure of the group alerting and dispatching system before the Telephone Company has been notified as provided herein and before it has had a reasonable time to restore service.

2. Group alerting and dispatching system equipment is provided only after written authorization is obtained from the responsible municipal, civic or other managing official having jurisdiction over the company, service, city, municipality, group, etc. for which such equipment is proposed to be installed.

3. Customer owned equipment and facilities used in connection with group alerting and dispatching systems, i.e. fire siren relays, monitor recording devices, shall not be located on the premises of the Telephone Company's central office building.

4. Service features, other than those regularly available with the standard group alerting and dispatching systems described herein, are furnished wherever practicable, if not detrimental to the service. Additional monthly and/or non-recurring charges based on the costs incurred apply.

5. Where unusual installation and/or construction work is involved to provide a requested group alerting and dispatching system or associated service, the regulations as specified in the "Construction **Charges and Other Special Charges**" section of this tariff will apply.

(T)

6. The customer shall furnish, install and maintain the commercial power and convenience outlets to properly operate any apparatus, equipment or customer owned device to be used in connection with a group alerting and dispatching system provided by this Telephone Company.

ISSUED:
May 22, 2020

BY: Darlene Terry
Manager, Tariffs

EFFECTIVE:
June 1, 2020

Received by NPSC
09/25/2020

GENERAL EXCHANGE TARIFF

UNITED TELEPHONE COMPANY
OF THE WEST
NEBRASKA

Section 21
First Revised Sheet 3
Canceling Original Sheet 3

PUBLIC EMERGENCY REPORTING SERVICE (Cont'd)

C. RATES

1. The following rates are applicable to the systems as indicated: (C)
- | | <u>Monthly
Rate</u> | |
|---|-------------------------|-----|
| *AFAC1 G
(Number 5 Firebar, each
individual line connected) | \$ 2.20 | |
| AFAC1 CPL (Chappell) | \$44.00 | (N) |
| AFAC1 LYN (Lyman) | \$44.00 | (N) |
| AFAC1 MRL (Morrill) | \$59.40 | (N) |
2. Installation and monthly rates for future emergency reporting systems and additions to existing systems, other than number 5 Firebar systems, are to be determined on an individual basis in accordance with the provisions in the "Special Equipment and Arrangements" portion of the General Rules and Regulations of this tariff. Rates will be tarified when the systems are placed in service. (N)

* Limited to existing customers at existing locations.

ISSUED: July 15, 1986

BY: I. B. Watson
Vice President - Administration
6666 West 110th Street
Overland Park, Kansas 66211

EFFECTIVE: August 1, 1986
Docket No. C-574

Information previously found in this section has been moved to Section 11, Page 11 (D)
of the General Exchange Price List.

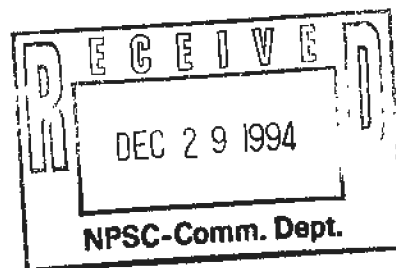

ISSUED:
December 29, 1994

BY: John L. Roe
Vice President
5454 West 110th Street
Overland Park, Kansas 66211

EFFECTIVE:
January 9, 1995

(D)

GENERAL EXCHANGE TARIFF

UNITED TELEPHONE COMPANY
OF THE WEST d/b/a CenturyLink
NEBRASKA

Section 23
Seventh Revised Sheet 1
Cancels Sixth Revised Sheet 1

CONNECTIONS WITH CERTAIN FACILITIES OF CUSTOMERS

A. GENERAL

1. All multi-line telephone systems connected to the Company's network on or after February 16, 2020, must be configured to allow direct "911" dialing by any end user and must be configured to send MLTS notifications as described in 1. of the Multi-Line Telephone Systems section under General Rules and Regulations Applying to Telephone Service. (T)
2. **Multiline telephone systems ("MLTS") required to comply with 1. preceding must be capable of conveying the dispatchable location of a 911 caller to a public safety answering point ("PSAP") as described in 2. of the Multi-Line Telephone Systems section under General Rules and Regulations Applying to Telephone Service.** (N)
3. Customer-provided terminal equipment, customer premise inside wire, protective circuitry, and communications systems may be used with the facilities furnished by the Telephone Company for telecommunications services as provided in the following paragraphs of this Section and Section 11 and 27 of the General Exchange Tariff. In all such cases the customer-provided terminal equipment, premise inside wire or communications systems will be so constructed, maintained and operated as to work satisfactorily with the facilities of the Telephone Company. (T)
4. Where telecommunications service is available under this tariff for use in connection with customer-provided terminal equipment, customer premise inside wire, protective circuitry, or communications systems, the operating characteristics of such equipment, wire, or system shall be such as not to interfere with any of the services offered by the Telephone Company. Such use is subject to the further provisions that the customer-provided equipment, customer premise inside wire or system does not endanger the safety of Telephone Company employees or the public; damage, require change in or alteration of, the equipment or other facilities of the Telephone Company; interfere with the proper functioning of such equipment or facilities; impair the operation of the telecommunications system or otherwise injure the public in its use of the Telephone Company's service. Upon notice from the Telephone Company that the customer-provided equipment, customer premise inside wire, or system is causing or is likely to cause such hazard or interference the customer shall make such change as shall be necessary to remove or prevent such hazard or interference the customer shall make such change as shall be necessary to remove or prevent such hazard or interference. The customer shall be responsible for the payment of Telephone Company charges, as specified in Section 11 of this tariff, for visits by the Telephone Company to the customer's premises where a service difficulty or trouble report results from customer-provided equipment, system, or customer premise inside wire. (T)
5. The Company shall not be responsible for the installation, operation or maintenance of any customer-provided terminal equipment, customer premise inside wire, protective circuitry, or communications systems. Telecommunications service is not represented as adapted to the use of systems and where such are connected to Company facilities the responsibility of the Company shall be limited to the furnishing of facilities suitable for telecommunications service and to the maintenance and operation of such facilities in a manner proper for such telecommunications service: subject to this responsibility the Company shall not be responsible for (1) the through transmission of signals generated by the customer-provided equipment, customer premise inside wire, protective circuitry, or systems or for the quality of, or defects in, such transmission, or (2) the reception of signals by customer-provided equipment, customer premise inside wire, protective circuitry, or systems. (T)

ISSUED:
May 20, 2021

BY: Darlene Terry
Director, Tariffs

EFFECTIVE:
July 1, 2021

NEB. GEN. EXCH. TARIFF

Received by NPSC
05/19/2021

GENERAL EXCHANGE TARIFF

UNITED TELEPHONE COMPANY
OF THE WEST d/b/a CenturyLink
NEBRASKA

Section 23
Third Revised Sheet 1A
Cancels Second Revised Sheet 1A

CONNECTIONS WITH CERTAIN FACILITIES OF CUSTOMERS

A. GENERAL (Cont'd)

6. The Telephone Company will not be responsible to the subscriber or otherwise if changes in the Company's communications facilities, equipment, operations or procedures renders the customer-provided terminal equipment, customer premise inside wire, protective circuitry, or communications systems obsolete or require modification or alteration of such equipment. The Telephone Company will give at least 90 days notice in writing if such changes can reasonably be expected to occur, allowing the customer an opportunity to maintain uninterrupted service. (T)
7. The Telephone Company will not be responsible for any loss or damage, nor for any impairment or failure of the service, arising from or in connection with the use of facilities of customers and not caused solely by the negligence of the Telephone Company. (T)
8. Satisfactory performance of the telecommunications network requires continuing functional compatibility of the network control signals and the switching equipment involved. To assure such continuing compatibility, network control signaling in the furnishing of telecommunications service shall be performed by equipment furnished, installed and maintained by the Telephone Company unless the customer-provided terminal equipment or protective circuitry meet the requirements of Part 68 of the F.C.C. Rules and Regulations. (T)
9. Where any customer-provided equipment, customer premise inside wire, protective circuitry, or communication system is used with telecommunications service in violation of any of the provisions in this tariff, the Telephone Company will take such immediate action as necessary for the protection of its services, and will promptly notify the customer of the violation. (T)

The customer shall discontinue such use of the equipment or system or correct the violation and shall confirm in writing to the Company within 10 days, following the receipt of written notice from the Company, that such use has ceased or that the violation has been corrected. Failure of the customer to discontinue such use or to correct the violation and to give the required written confirmation to the Telephone Company within the time stated above shall result in termination of the customer's service until such time as the customer complies with the provisions of this tariff.

ISSUED:
May 20, 2021

BY: Darlene Terry
Director, Tariffs

EFFECTIVE:
July 1, 2021

20210520

Received by NPSC
05/19/2021

GENERAL EXCHANGE TARIFF

UNITED TELEPHONE COMPANY
OF THE WEST d/b/a CenturyLink
NEBRASKA

Section 23
Sixth Revised Sheet 2
Cancels Fifth Revised Sheet 2

CONNECTIONS WITH CERTAIN FACILITIES OF CUSTOMERS

A. GENERAL (Cont'd)

10. Customer-provided terminal equipment or communications systems which serve a location which the Telephone Company considers impracticable to serve because of hazard or inaccessibility may be connected with telecommunications service only by means of a connecting equipment. (T)
11. The customer indemnifies and saves the Telephone Company harmless against claims for infringement of patents arising from combining such equipment or system with, or using it in connection with, facilities of the Telephone Company; and against all other claims arising out of any act or omission of the customer in connection with facilities provided by the Telephone Company. (T)
12. The customer must provide all the electrical power necessary for the operation of customer-provided communications systems equipment and associated lines to the point of interconnection. (T)
13. Terminal equipment and/or protective circuitry lawfully connected directly to the Telephone Company's exchange facilities in each exchange as of October 17, 1977, where compatible, may continue to be connected for the life of the equipment in the same or compatible exchange without being registered, unless subsequently modified. (T)
14. Entire PBX or key telephone systems, including their equipment and protective apparatus (if any), lawfully connected directly to the Telephone Company's exchange facilities, in each exchange, as of June 1, 1978, may continue to be connected for the life of the equipment in the same or a compatible exchange without being registered, unless subsequently modified. Additions to such system may be made up to July 1, 1979, without registration of any additional equipment involved provided that:
 - a. Any equipment added is of a type directly connected to the telephone network as of October 17, 1977.(T)

Changes to PBX or key telephone systems covered in this paragraph may only be made by the manufacturer of the PBX or key telephone system, or a duly authorized agent of the manufacturer.

ISSUED:
May 20, 2021

BY: Darlene Terry
Director, Tariffs

EFFECTIVE:
July 1, 2021

GENERAL EXCHANGE TARIFF

UNITED TELEPHONE COMPANY
OF THE WEST d/b/a CenturyLink
NEBRASKA

Section 23
Fourth Revised Sheet 2A
Cancels Third Revised Sheet 2A

CONNECTIONS WITH CERTAIN FACILITIES OF CUSTOMERS

A. GENERAL (Cont'd)

16. Terminal equipment and protective circuitry of a type lawfully connected directly to the Telephone Company's exchange facilities in each exchange as of October 17, 1977, where compatible, may be connected thereafter in the same or compatible exchange until July 1, 1979, at which time all terminal equipment and protective circuitry, other than terminal equipment and protective circuitry covered in paragraph 11. above, must be registered in accordance with Part 68 of the F.C.C. Rules and Regulations. (T)
16. PBX or key telephone systems of a type lawfully connected directly to the Telephone Company's exchange facilities in each exchange as of October 17, 1977, where compatible, may be connected after June 1, 1978, in the same or compatible exchange until July 1, 1979, at which time all PBX or key telephone systems covered in paragraph 12. above, must be registered in accordance with Part 68 of the F.C.C. Rules and Regulations. Changes to PBX or key telephone systems covered in this paragraph may only be made by the manufacturer of the PBX or key telephone system, or a duly authorized agent of the manufacturer. (T)
17. Terminal equipment protective circuitry, and PBX or key telephone systems, of a type not lawfully connected directly to the Telephone Company's exchange facilities in each exchange on October 17, 1977, where compatible, may be directly connected after July 1, 1979, in the same or a compatible exchange only if the customer-provided terminal equipment, protective circuitry or PBX or key telephone systems has been registered in accordance with Part 68 of the F.C.C. Rules and Regulations. (T)
18. PBX or key telephone systems of a type lawfully connected directly to the Telephone Company's exchange facilities in each exchange as of October 17, 1977, or registered in accordance with Part 68 of the F.C.C. Rules and Regulations, and are presently connected to the Telephone Company's exchange facilities by protective apparatus, may remove such protective apparatus and connect directly if the following conditions are met: (T)
- a. All equipment in the system are of a type directly connected to the telephone network as of October 17, 1979, or are registered in accordance with Part 68 of the F.C.C. Rules and Regulations.

ISSUED:
May 20, 2021

BY: Darlene Terry
Director, Tariffs

EFFECTIVE:
July 1, 2021

NPSC 2021-10

Received by NPSC
05/19/2021

GENERAL EXCHANGE TARIFF

UNITED TELEPHONE COMPANY
OF THE WEST d/b/a CenturyLink
NEBRASKA

Section 23
Sixth Revised Sheet 2B
Cancels Fifth Revised Sheet 2B

CONNECTIONS WITH CERTAIN FACILITIES OF CUSTOMERS

A. GENERAL (Cont'd)

19. Terminal equipment not registered nor grandfathered in accordance with Part 68 of the F.C.C. Rules and Regulations may be connected to the network pursuant to the tariff provisions in effect prior to October 17, 1977, requiring the use of a network control signaling unit and connecting arrangement, or customer-provided protective circuitry registered in accordance with Part 68 of the F.C.C. Rules and Regulations. (T)
20. The Telephone Company will not be liable for damages arising out of injuries to persons or property from voltages or currents transmitted over the facilities of the Telephone Company caused by customer-provided terminal equipment or protective circuitry. (T)

B. CUSTOMER-PROVIDED TERMINAL EQUIPMENT

1. Data Transmitting and/or Receiving Terminal Equipment Customer-provided data transmitting and/or receiving terminal equipment which involves direct electrical connection to the facilities furnished by the Telephone Company may be used with such facilities for telecommunications service either through a data set, or a data access arrangement as described in a. respectively. Use of such service is on a two-point basis.

ISSUED:
May 20, 2021

BY: Darlene Terry
Director, Tariffs

EFFECTIVE:
July 1, 2021

NPSC 05/19/2021

Received by NPSC
05/19/2021

GENERAL EXCHANGE TARIFF

UNITED TELEPHONE COMPANY
OF THE WEST
NEBRASKA

Section 23
Fifth Revised Sheet 3
Canceling Fourth Revised Sheet 3

CONNECTIONS WITH CERTAIN FACILITIES OF CUSTOMERS

B. Customer-Provided Terminal Equipment (Cont'd)

1. Data Transmitting and/or Receiving Terminal Equipment (Cont'd)

a. Data Set

Where the customer elects to use customer-provided data transmitting and/or receiving terminal equipment with a data set furnished by the Telephone Company the data set shall perform the functions of:

- (1) Network control signaling
- (2) Conditioning data signals generated by the customer-provided equipment to signals suitable for transmission by means of Telephone Company facilities and
- (3) Conditioning signals transmitted by means of Telephone Company facilities to data signals suitable for reception by customer-provided equipment.

Teletypewriter equipment when used with a data set will be provided by the customer.

(D)

(D)

ISSUED: July 15, 1986

BY: I. B. Watson
Vice President - Administration
6666 West 110th Street
Overland Park, Kansas 66211

EFFECTIVE: August 1, 1986
Docket No. C-574

GENERAL EXCHANGE TARIFF

UNITED TELEPHONE COMPANY
OF THE WEST
NEBRASKA

Section 23
Second Revised Sheet 3A
Canceling First Revised Sheet 3A

CONNECTIONS WITH CERTAIN FACILITIES OF CUSTOMERS

(Reserved For Future Use)

(D)

(D)

ISSUED: July 15, 1986

BY: I. B. Watson
Vice President - Administration
6666 West 110th Street
Overland Park, Kansas 66211

EFFECTIVE: August 1, 1986
Docket No. C-574

GENERAL EXCHANGE TARIFF

UNITED TELEPHONE COMPANY
OF THE WEST
NEBRASKA

Section 23
Second Revised Sheet 3B
Canceling First Revised Sheet 3B

CONNECTIONS WITH CERTAIN FACILITIES OF CUSTOMERS

(Reserved For Future Use)

(D)

(D)

ISSUED: July 15, 1986

BY: I. B. Watson
Vice President - Administration
6666 West 110th Street
Overland Park, Kansas 66211

EFFECTIVE: August 1, 1986
Docket No. C-574

GENERAL EXCHANGE TARIFF

UNITED TELEPHONE COMPANY
OF THE WEST
NEBRASKA

Section 23
Fourth Revised Sheet 4
Canceling Third Revised Sheet 4

CONNECTIONS WITH CERTAIN FACILITIES OF CUSTOMERS

B. Customer-Provided Terminal Equipment (Cont'd)

1. Data Transmitting and/or Receiving Terminal Equipment (Cont'd)

c. Data Access Arrangement

Where the customer elects to use customer-provided data transmitting and/or receiving terminal equipment through a data access arrangement:

- (1) The customer shall furnish the equipment which performs the functions of data signal conditioning referred to under B.1.a.(2). and B.1.a.(3). above.
- (2) The data access arrangement provides a protective connecting arrangement for use with the network control signaling unit. In lieu of the connecting arrangement an arrangement may be used with the network control signaling unit to identify a central office line and protective facilities and procedures to determine compliance with criteria set forth in (3) following.
- (3) To protect the telecommunications network and the service furnished to the general public by the Telephone Company from harmful effects, the customer-provided data transmitting equipment must comply with the following minimum network protection criteria:
 - (a) To prevent excessive noise and crosstalk in the network, it is necessary that the power of the signal at the central office shall not exceed 12db below one milliwatt when averaged over any three second interval. To permit each customer, independent of distance from the central office, to supply signal power which approximates the 12db below one milliwatt limit at the central office, the power of the signal which may be applied by the customer-provided equipment to the Telephone Company interface

(D)

RECEIVED

DEC 1 1987

ACCT. & ENGI. DEPARTMENT
Nebr. Public Service Commission

ISSUED:

BY: I. B. Watson
Vice President - Administration
6666 West 110th Street
Overland Park, Kansas 66211

EFFECTIVE:

GENERAL EXCHANGE TARIFF

UNITED TELEPHONE COMPANY
OF THE WEST
NEBRASKA

Section 23
Third Revised Sheet 5
Canceling Second Revised Sheet 5

CONNECTIONS WITH CERTAIN FACILITIES OF CUSTOMERS

B. Customer-Provided Terminal Equipment (Cont'd)

1. Data Transmitting and/or Receiving Terminal Equipment (Cont'd)

c. Data Access Arrangement

(3) (Cont'd)

(a) (Cont'd)

located on the customer's premises will be specified for each customer's location, but in no case shall it exceed one milliwatt.

(b) To protect other services it is necessary that the signal which is applied by the customer-provided equipment to the Company interface located on the customer's premises meet the following limits:

(i) The power in the band from 3,995 Hertz to 4,005 Hertz shall be at least 18db below the power of the signal as specified in B.1.b.(3)(a) above.

(ii) The power in the band from 4,000 Hertz to 10,000 Hertz shall not exceed 16db below one milliwatt.

(iii) The power in the band from 10,000 Hertz to 25,000 Hertz shall not exceed 24db below one milliwatt.

(iv) The power in the band from 25,000 Hertz to 40,000 Hertz shall not exceed 36db below one milliwatt.

(v) The power in the band above 40,000 Hertz shall not exceed 50db below one milliwatt.

(c) To prevent the interruption or disconnection of a call, or interference with network control signaling, it is necessary that the signal applied by the customer-provided equipment to the Company interface located on the customer's premises at no time have energy solely in the 2450 to 2750 Hertz band. If signal power is in the 2450 to 2750 Hertz band, it must not exceed the power present at the same time in the 800 to 2450 Hertz band.

(4)

(D)

ISSUED: May 2, 1983

EFFECTIVE: June 1, 1983

BY: J. T. Cluen
Assistant Vice President -
Revenue Requirements
6666 West 110th Street
Overland Park, Kansas 66211

GENERAL EXCHANGE TARIFF

UNITED TELEPHONE COMPANY
OF THE WEST
NEBRASKA

Section 23
Fifth Revised Sheet 6
Canceling Fourth Revised Sheet 6

CONNECTIONS WITH CERTAIN FACILITIES OF CUSTOMERS

B. Customer-Provided Terminal Equipment (Cont'd)

I. Data Transmitting and/or Receiving Terminal Equipment (Cont'd)

d. Acoustic, Inductive Connections

(1) Customer-provided data transmitting and/or receiving terminal equipment (including telephotograph equipment) may be acoustically or inductively connected with Company facilities for telecommunications service provided the acoustic or inductive connection is made externally to a network control signaling unit. Use of such service is on two-point basis. (c)

(2) To protect the telecommunications network and the services furnished to the general public by the Telephone Company from harmful effects, the customer-provided data transmitting equipment must comply with the following minimum network protection criteria:

(a) To prevent excessive noise and crosstalk in the network, it is necessary that the power of the signal which is applied by the customer-provided equipment to the network control signaling unit located on the customer's premises be limited so that the signal power at the output of the network control signaling unit (i.e., at the input to the Telephone Company line) does not exceed 9db below one milliwatt when averaged over any three second interval.

(b) To protect other services, it is necessary that the signal which is applied by the customer-provided equipment to the network control signaling unit located on the customer's premises meet the following limits at the output of the network control signaling unit (i.e., at the input to the Company line):

(i) The power in the band from 3,995 Hertz to 4,005 Hertz shall be at least 18db below the power of the signal as specified in B.1.a. 2)(a) above.

ISSUED:

BY: I. B. Watson
Vice President - Administration
6666 West 110th Street
Overland Park, Kansas 66211

EFFECTIVE **DEC 1 1987**

RECEIVED
ACCT. & ENGI. DEPARTMENT
Nebr. Public Service Commission

GENERAL EXCHANGE TARIFF

UNITED TELEPHONE COMPANY
OF THE WEST
NEBRASKA

Section 23
Original Sheet 6A

CONNECTIONS WITH CERTAIN FACILITIES OF CUSTOMERS

B. Customer-Provided Terminal Equipment (Cont'd)

1. Data Transmitting and/or Receiving Terminal Equipment (Cont'd)

d. Acoustic, Inductive Connections (Cont'd)

(2) (Cont'd)

(b) (Cont'd)

(ii) The power in the band from 4,000 Hertz to 10,000 Hertz shall not exceed 16db below one milliwatt.

(iii) The power in the band from 10,000 Hertz to 25,000 Hertz shall not exceed 24db below one milliwatt.

(iv) The power in the band from 25,000 Hertz to 40,000 Hertz shall not exceed 36db below one milliwatt.

(v) The power in the band above 40,000 Hertz shall not exceed 50db below one milliwatt.

(c) To prevent the interruption or disconnection of a call, or interference with network control signaling, it is necessary that the signal applied by the customer-provided equipment to the network control signaling unit located on the customer's premises be limited so that the signal at the output of the network control signaling unit (i.e., at the input to the Telephone Company line) shall at no time have energy solely in the 2450 to 2750 Hertz band. If there is signal power at the output of the network control signaling unit in the 2450 to 2750 Hertz band, it must not exceed the power present at the same time in the 800 to 2450 Hertz band.

2. Voice Transmitting and/or Receiving Terminal Equipment

a. Direct Electrical Connections

Customer-provided voice transmitting and/or receiving terminal equipment which involves direct electrical connection to the facilities furnished by the Telephone Company for telecommunications service may be used with such facilities in accordance

ISSUED: May 2, 1983

EFFECTIVE: June 1, 1983

BY: J. T. Cluen
Assistant Vice President -
Revenue Requirements
6666 West 110th Street
Overland Park, Kansas 66211

GENERAL EXCHANGE TARIFF

UNITED TELEPHONE COMPANY
OF THE WEST
NEBRASKA

Section 23
First Revised Sheet 6B
Canceling Original Sheet 6B

CONNECTIONS WITH CERTAIN FACILITIES OF CUSTOMERS

B. Customer-Provided Terminal Equipment (Cont'd)

2. Voice Transmitting and/or Receiving Terminal Equipment (Cont'd)

a. Direct Electrical Connections (Cont'd)

with (1) and (2) following, except where otherwise specified in this tariff:

- (1) The connection shall be made through a network control signaling unit (except customer-provided tone-type address signaling through a connecting arrangement, or through customer-provided equipment which affects connections externally to a network control signaling unit by means of an acoustic or inductive connection) and a connecting arrangement, and (C)
- (2) To protect the telecommunications network and the services furnished to the general public by the Telephone Company from harmful effects, the customer-provided voice transmitting equipment must comply with the following minimum network protection criteria: (C)

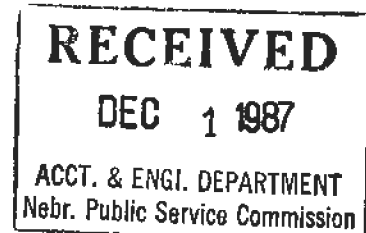

ISSUED:

BY: I. B. Watson
Vice President - Administration
6666 West 110th Street
Overland Park, Kansas 66211

EFFECTIVE:

CONNECTIONS WITH CERTAIN FACILITIES OF CUSTOMERS

(C)

B. CUSTOMER-PROVIDED TERMINAL EQUIPMENT (Continued)

2. Voice Transmitting and/or Receiving Terminal Equipment (Continued)

a. Direct Electrical Connections (Continued)

(2) (Continued)

(b) To protect other services it is necessary that the signal which is applied by the customer-provided equipment to the Company interface located on the customer's premises meet the following limits:

(i) The power in the band from 3,995 Hertz to 4,005 Hertz shall be at least 18db below the power of the signal as specified in B.2.a.(2)(a) above.

(ii) The power in the band from 4,000 Hertz to 10,000 Hertz shall not exceed 16db below one milliwatt.

(iii) The power in the band from 10,000 Hertz to 25,000 Hertz shall not exceed 24db below one milliwatt.

(iv) The power in the band from 25,000 Hertz to 40,000 Hertz shall not exceed 36db below one milliwatt.

(v) The power in the band above 40,000 Hertz shall not exceed 50db below one milliwatt.

(c) To prevent the interruption or disconnection of a call, or interference with network control signaling, it is necessary that the signal applied by the customer-provided equipment to the Telephone Company interface located on the customer's premises at no time have energy solely in the 2450 to 2750 Hertz band. If signal power is in the 2450 to 2750 Hertz band, it must not exceed the power present at the same time in the 800 to 2450 Hertz band.

b. Acoustic, Inductive Connections

(1) Customer-provided voice transmitting and/or receiving terminal equipment may be acoustically or inductively connected with Telephone Company facilities for telecommunications service provided the acoustic or inductive connection is made externally to a Telephone Company network control signaling unit.

(2) To protect the telecommunications network and the service furnished to the general public by the Telephone Company from harmful effects, the customer-provided voice transmitting equipment must comply with the following minimum network protection criteria:

(C)

GENERAL EXCHANGE TARIFF

UNITED TELEPHONE COMPANY
OF THE WEST
NEBRASKA

Section 23
Third Revised Sheet 8
Canceling Second Revised Sheet 8

CONNECTIONS WITH CERTAIN FACILITIES OF CUSTOMERS

B. CUSTOMER PROVIDED TERMINAL EQUIPMENT (Cont'd)

2. Voice Transmitting and/or Receiving Terminal Equipment(Cont'd)

b. Acoustic, Inductive Connections

(1) Customer-provided voice transmitting and/or receiving terminal equipment may be acoustically or inductively connected with Telephone Company facilities for telecommunications service provided the acoustic or inductive connection is made externally to a network control signalling unit. (C)

(2) To protect the telecommunications network and the service furnished to the general public by the Telephone Company from harmful effects, the customer-provided voice transmitting equipment must comply with the following minimum network protection criteria:

(a) To prevent excessive noise and crosstalk in the network, it is necessary that the power of the signal which is applied by the customer-provided equipment to the network control signaling unit located on the customer's premises be limited so that the signal power at the output of the network control signaling unit (i.e., at the input to the Telephone Company line) does not exceed 9db below one milliwatt when averaged over any three second interval.

b) To protect other services it is necessary that the signal which is applied by the customer-provided equipment to the Company interface located on the customer's premises meet the following limits:

(i) The power in the band from 3,995 Hertz to 4,005 Hertz shall be at least 18db below the power of the signal as specified in B.2.b.(2)(a) above.

(ii) The power in the band from 4,000 Hertz to 10,000 Hertz shall not exceed 16db below one milliwatt.



ISSUED:

BY: I. B. Watson
Vice President - Administration
6666 West 110th Street
Overland Park, Kansas 66211

EFFECTIVE:

GENERAL EXCHANGE TARIFF

UNITED TELEPHONE COMPANY
OF THE WEST
NEBRASKA

Section 23
Original Sheet 8A

B. CUSTOMER-PROVIDED TERMINAL EQUIPMENT(Cont'd)

2. Voice Transmitting and/or Receiving Terminal Equipment(Cont'd) (L)

(2) (b) (Cont'd)

- (iii) The power in the band from 10,000 Hertz to 25,000 Hertz shall not exceed 24db below one milliwatt.
 - (iv) The power in the band from 25,000 Hertz to 40,000 Hertz shall not exceed 36db below one milliwatt.
 - (v) The power in the band above 40,000 Hertz shall not exceed 50db below one milliwatt.
- (c) To prevent the interruption or disconnection of a call, or interference with network control signaling, it is necessary that the signal applied by the customer-provided equipment to the network control signaling unit located on the customer's premises be limited so that the signal at the output of the network control signaling unit (i.e., at the input to the Telephone Company line) shall at no time have energy solely in the 2450 to 2750 Hertz band. If there is signal power at the output of the network control signalling unit in the 2450 to 2750 band, it must not exceed the power present at the same time in the 800 to 2450 Hertz band.

3. Accessories

Customer-provided accessories may be used with the facilities furnished by the Telephone Company for telecommunications service. (L)



ISSUED:

BY: I. B. Watson
Vice President - Administration
6666 West 110th Street
Overland Park, Kansas 66211

EFFECTIVE:

GENERAL EXCHANGE TARIFF

UNITED TELEPHONE COMPANY
OF THE WEST
NEBRASKA

Section 23
Seventh Revised Sheet 9
Cancels Sixth Revised Sheet 9

CONNECTIONS WITH CERTAIN FACILITIES OF CUSTOMERS

B. CUSTOMER-PROVIDED TERMINAL EQUIPMENT (Cont'd)

4. Direct Electrical Connection

Where the use of any customer-provided terminal equipment as specified in these regulations involves direct electrical connection to the facilities furnished by the telephone company, such connection shall be made through a connection arrangement in accordance with the specifications listed in B.5. following.

5. Connection of FCC Registered Equipment

a. FCC registered terminal equipment, protective circuitry, data equipment, or communications systems may be directly connected to the telephone company's exchange facilities in accordance with 1 and 2 following:

(T)

- (1) Customer-provided terminal equipment, protective circuitry, data equipment, or communications systems, directly connected to exchange facilities must be registered in accordance with Part 68 of the FCC Rules and Regulations.

(D)

(D)

ISSUED:
June 16, 2009

BY: Darlene Terry
Manager, Tariffs

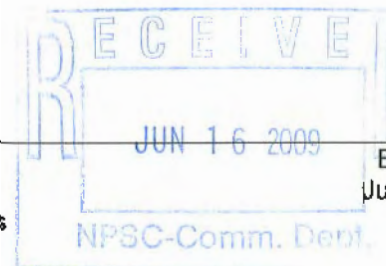

EFFECTIVE:
June 26, 2009

GENERAL EXCHANGE TARIFF

UNITED TELEPHONE COMPANY
OF THE WEST
NEBRASKA

Section 23
Fourth Revised Sheet 9A
Cancels Third Revised Sheet 9A

CONNECTIONS WITH CERTAIN FACILITIES OF CUSTOMERS

B. CUSTOMER-PROVIDED TERMINAL EQUIPMENT (Cont'd)

5. Connection of F.C.C. Registered Equipment (Cont'd)

a. **FCC registered terminal equipment, protective circuitry ...** (Cont'd) (T)

(D)

(2) Customers connecting terminal equipment, protective circuitry, data equipment or communications systems to the telephone network shall, upon request of the Telephone Company, inform the Telephone Company of: (T)

i. The F.C.C. Registration Number, and

ii. The Ringer Equivalence Number of the registered terminal equipment or registered protective circuitry, and

iii. The line number or directory number to which the terminal equipment, protective circuitry, or data equipment, will be connected.

iv. Other such information that may be required to assure the compatibility of the connected equipment.

ISSUED:
June 16, 2009

BY: Darlene Terry
Manager, Tariffs

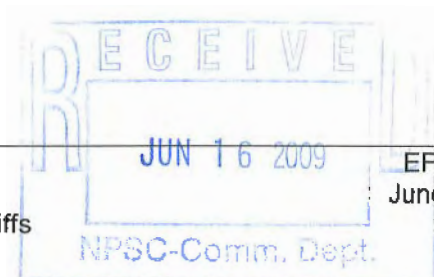

EFFECTIVE:
June 26, 2009

GENERAL EXCHANGE TARIFF

UNITED TELEPHONE COMPANY
OF THE WEST
NEBRASKA

Section 23
Sixth Revised Sheet 10
Cancels Fifth Revised Sheet 10

CONNECTIONS WITH CERTAIN FACILITIES OF CUSTOMERS

B. CUSTOMER-PROVIDED TERMINAL EQUIPMENT (Cont'd)

5. Connection of F.C.C. Registered Equipment (Cont'd)

a. **FCC registered terminal equipment, protective circuitry ...** (Cont'd) (T)

(D)

(D)

(3) In the event customer-provided terminal equipment or protective circuitry causes harm to the network, the Telephone Company will, where practicable, notify the customer that temporary discontinuance of service may be required; however, where prior notice is not practicable, the Telephone Company will, (1) promptly notify the customer of such temporary discontinuance, (2) afford the customer the opportunity to correct the situation which gave rise to the temporary discontinuance, and (3) inform the customer of his right to bring a complaint to the F.C.C. pursuant to the procedures set forth in Part 68 of the F.C.C. Rules and Regulations. (T)

(4) Technical information concerning interface parameters sufficient to allow the customer to properly interconnect his terminal equipment, including the number of ringers which may be connected to a particular telephone line shall be provided by the Telephone Company upon request. (T)

C. CUSTOMER-PROVIDED COMMUNICATIONS SYSTEMS

1. Except as provided for elsewhere in this tariff the connection of customer-provided communications systems will be in accordance with the following provisions.

ISSUED:
June 16, 2009

BY: Darlene Terry
Manager, Tariffs

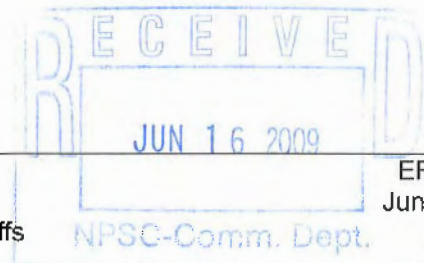

EFFECTIVE:
June 26, 2009

GENERAL EXCHANGE TARIFF

UNITED TELEPHONE COMPANY
OF THE WEST
NEBRASKA

Section 23
Second Revised Sheet 10A
Cancels First Revised Sheet 10A

CONNECTIONS WITH CERTAIN FACILITIES OF CUSTOMERS

C. CUSTOMER-PROVIDED COMMUNICATIONS SYSTEMS (Cont'd) (Z)

1. **Except as provided for elsewhere in this tariff ...** (Cont'd) (T)

- a. Customer-provided communications systems may be connected at a service point of the customer on a voice grade basis with telecommunications service furnished by the Company, either through a network control signaling unit and connecting arrangement or as otherwise specified in Part 68 of the F.C.C. Rules and Regulations. The customer-provided system shall comply with the minimum network protection criteria contained in B.2.a.(2) and B.2.b.(2).
- b. Telephone instruments used in connection with exchange and private line telephone services may be used alternately with customer-provided private mobile radiotelephone systems. Transfer of instruments to the alternate position for communication with the private mobile radiotelephone system will be made by means of a key or footswitch. If use arrangements are required at more than one location, a multi-point operations channel terminated in a key or footswitch at the respective locations must be provided.

ISSUED:
June 16, 2009

BY: Darlene Terry
Manager, Tariffs

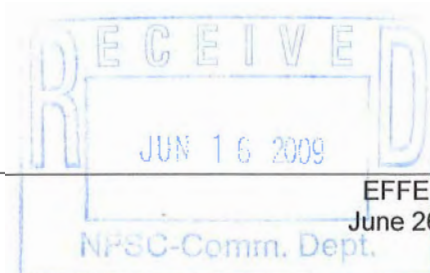

EFFECTIVE:
June 26, 2009

GENERAL EXCHANGE TARIFF

UNITED TELEPHONE COMPANY
OF THE WEST
NEBRASKA

Section 23
Fifth Revised Sheet 11
Cancels Fourth Revised Sheet 11

CONNECTIONS WITH CERTAIN FACILITIES OF CUSTOMERS

C. CUSTOMER-PROVIDED COMMUNICATIONS SYSTEMS (Cont'd)

1. **Except as provided for elsewhere in this tariff ...** (Cont'd)

(T)

- c. Connecting arrangements are offered for new installations (including additions), at rates specified below, only as available from the Company's existing stock. However, connecting arrangements being furnished as of December 1, 1977, may be continued for the same customer at the same premises.

(D)

D. U.S. ARMY, NAVY AND AIR FORCE

Except as provided for elsewhere in this tariff (especially in Section 23, B.5.), facilities of a telephone system of the U.S. Department of the Army, Navy or Air Force which serves an establishment operated and administered under the direction of the Department and commanded by authorities of such establishment, may, in lieu of provisions contained in C.1.a. preceding, be connected with facilities of the Company for telecommunications service where the Secretary of the Department certifies in writing that reasons of military necessity require that the establishment be served by a telephone system of the Department. In addition, the facilities of temporary telephone system of such Department located off a permanent establishment of the Department for maneuvers, mobilization tests or technical service tests will be so connected.

E. U.S. COAST GUARD AND U.S. ARMY NATIONAL GUARD

Except as provided for elsewhere in this tariff (especially in Section 23, B.5.), the following customer-provided facilities may be connected to facilities of the Telephone Company:

- U.S. Coast Guard telephone facilities in coastal areas as an aid in saving and protecting life and property.
- U.S. Army National Guard radio facilities to provide two-way point-to-point communications in times of natural disasters or other emergencies, when local or toll facilities of the Telephone Company are out of service at or between either of the service points.

(M)

F. NATIONAL AERONAUTICS AND SPACE ADMINISTRATION

Except as provided for elsewhere in this tariff (especially in Section 23, B.5.), facilities of the National Aeronautics and Space Administration will be connected to facilities of the Telephone Company for exchange and message toll service by means of switching or connecting by the Telephone Company where the Director of the NASA or his authorized representative notifies the Telephone Company in writing that such connection is required for the control of space vehicles.

(M)

(M) Material now appearing on this page previously appeared on Second Revised Sheet 12.

ISSUED:
June 16, 2009

BY: Darlene Terry
Manager, Tariffs

EFFECTIVE:
June 26, 2009

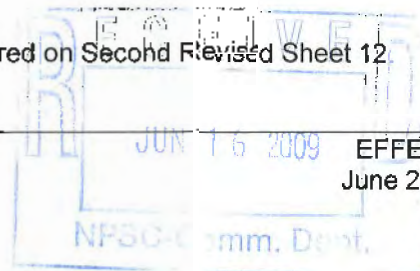

GENERAL EXCHANGE TARIFF

UNITED TELEPHONE COMPANY
OF THE WEST
NEBRASKA

Section 23
Third Revised Sheet 12
Cancels Second Revised Sheet 12

CONNECTIONS WITH CERTAIN FACILITIES OF CUSTOMERS

(M)
|
(M)

G. U.S. GOVERNMENT EXECUTIVE DEPARTMENTS AND AGENCIES

Except as provided for elsewhere in this tariff (especially in Section 23, B.5.), equipment of a department or agency of the Executive Branch of the U.S. Government used for the purpose of disguising or concealing the contents or meaning of communications may be connected to Telephone Company station equipment, or to Telephone Company facilities in lieu of such station equipment, subject to the regulations and conditions stated below:

1. The head of the department or agency whose equipment is to be connected, or his authorized representative, shall notify the Telephone Company in writing that such connection is necessary to safeguard official information which requires protection in the interests of national defense, or other confidential official information disclosure of which to unauthorized persons would be detrimental to the public interest.
2. The connection shall be made by means of connecting equipment or arrangements.

H. FEDERAL AVIATION AGENCY

Except as provided for elsewhere in this tariff (especially in Section 23, B.5.), private mobile systems provided by the Federal Aviation Agency may be connected by means of portable connecting equipment to Telephone Company facilities for telecommunications service.

I. POWER, PIPE LINE AND RAILROAD COMPANIES

Except as provided for elsewhere in this tariff (especially in Section 23, B.5.), the connection of customer-provided communications systems will be in accordance with the following provisions.

1. Facilities of an electric power company or oil, oil products or natural gas pipe line company, or railroad company, provided primarily to communicate with points located along a right-of-way (including premises of such company anywhere in cities, towns or villages along the right-of-way) owned or controlled by such company will be connected with facilities furnished by the Telephone Company to the same customer, subject to the regulations and conditions stated in I.1. to 3., inclusive, in addition to those specified in A. above. Such connections will be made by means of switching or connecting equipment.

(M1)
|
(T)
(M1)

(M) Material previously appearing on this page now appears on Fifth Revised Sheet 11.
(M1) Material now appearing on this page previously appeared on Second Revised Sheet 13.

ISSUED:
June 16, 2009

BY: Darlene Terry
Manager, Tariffs

EFFECTIVE:
June 26, 2009

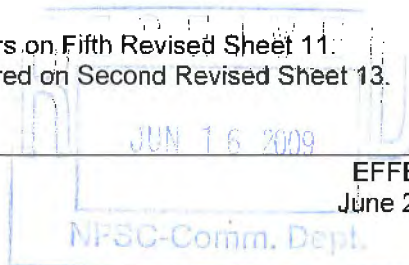

GENERAL EXCHANGE TARIFF

UNITED TELEPHONE COMPANY
OF THE WEST
NEBRASKA

Section 23
Third Revised Sheet 13
Cancels Second Revised Sheet 13

CONNECTIONS WITH CERTAIN FACILITIES OF CUSTOMERS

I. POWER, PIPE LINE AND RAILROAD COMPANIES (Cont'd)

1. **Facilities of an electric power company ...** (Cont'd)

(T)

(M)

(M)

2. Such customer telephone facilities may be connected to private branch exchange switchboards or other telephone switching or terminal equipments located in the same or different local service areas, for communication with stations and private line facilities associated with said switching or terminal equipment; provided, however, that, within the same local service area, a private branch exchange switchboard or other telephone switching or terminal equipment will not be connected **with private** telephone switching equipment of the customer except where such private telephone switching equipment is used exclusively for dispatching.

(C)

3. Facilities of the Telephone Company, when connected with facilities of the customer, will not be used for communications of other than the customer, except that such facilities may be used for the communications of, and be connected with facilities furnished by the Telephone Company to, other companies which:

- (a) are operated with the customer as parts of an integrated electric power, oil, oil products, or natural gas system or railroad system under direct or common ownership or control; or
- (b) own or operate electric power or pipe line or railroad system jointly with the customer; or
- (c) own or operate electric power or pipe line or railroad facilities interconnected with those of the customer.

(M) Material previously appearing on this page now appears on Third Revised Sheet 12.

ISSUED:
June 16, 2009

BY: Darlene Terry
Manager, Tariffs

EFFECTIVE:
June 26, 2009

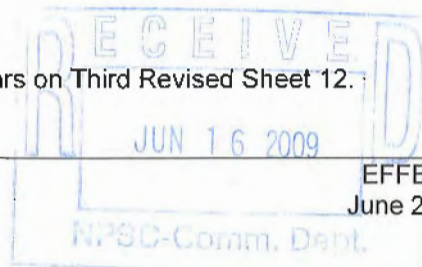

GENERAL EXCHANGE TARIFF

UNITED TELEPHONE COMPANY
OF THE WEST
NEBRASKA

Section 23
Original Sheet 13A

CONNECTIONS WITH CERTAIN FACILITIES OF CUSTOMERS

J. CONNECTION WITH CUSTOMER-PROVIDED ALARM DETECTION AND REPORTING EQUIPMENT (L)

1. Regulations

(a) Except as provided for elsewhere in this tariff (especially in Section 23, B.5.), the connection of customer-provided alarm detection and reporting equipment will be in accordance with the following provisions: (L)

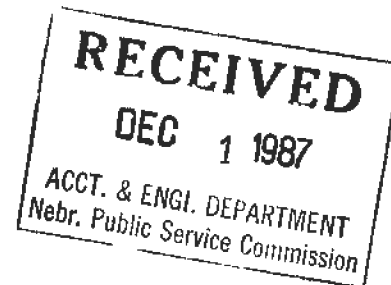

ISSUED:

BY: I. B. Watson
Vice President - Administration
6666 West 110th Street
Overland Park, Kansas 66211

EFFECTIVE:

GENERAL EXCHANGE TARIFF

UNITED TELEPHONE COMPANY
OF THE WEST
NEBRASKA

Section 23
Second Revised Sheet 14
Canceling First Sheet 14

CONNECTIONS WITH CERTAIN FACILITIES OF CUSTOMERS

J. Connection with Customer-Provided Alarm Detection and Reporting Equipment (Cont'd)

1. Regulations

- (1) Connection of customer-provided alarm detection and reporting equipment with the facilities of the Telephone Company shall be made only through an alarm coupler. The alarm coupler consists of a one-way interface unit which, in response to a signal from the customer's device, seizes the telephone line, transmits dial pulses corresponding to a predetermined telephone number and a prerecorded voice alarm report originated by the customer's device to the line and disconnects at the end of the report.
- (2) The alarm coupler is furnished for use in connection with telephone associated with individual lines or dial PBX and CENTREX station lines.
- (3) The alarm coupler is furnished for the purpose of reporting a condition or result of an operation of customer-provided equipment with which it is associated and shall not be used to connect any other customer-provided equipment with Telephone Company facilities.
- (4) Customer-provided alarm detection and reporting equipment connected through an alarm coupler shall not be used to interconnect any line or channel of the Telephone Company with any other line or channel of the Telephone Company or any other person.
- (5) The operating characteristics of the customer-provided alarm detection and reporting equipment shall be such that the equipment will function properly with the facilities of the Telephone Company and will not interfere with any of the services offered by the Telephone Company. Upon notice from the Telephone Company that the equipment of the customer is causing or is likely to cause hazard or interference, the customer shall make such changes as may be necessary to remove or prevent such hazard or interference.
- (6) Use of the customer-provided alarm detection and reporting equipment is permitted only on the condition that the liability

ISSUED: May 2, 1983

EFFECTIVE: June 1, 1983

BY: J. T. Cluen
Assistant Vice President -
Revenue Requirements
6666 West 110th Street
Overland Park, Kansas 66211

GENERAL EXCHANGE TARIFF

UNITED TELEPHONE COMPANY
OF THE WEST
NEBRASKA

Section 23
Third Revised Sheet 15
Canceling Second Revised Sheet 15

CONNECTIONS WITH CERTAIN FACILITIES OF CUSTOMERS

J. Connection with Customer-Provided Alarm Detection and Reporting Equipment (Cont'd)

1. Regulations (Cont'd)

(6) (Cont'd)

of the Telephone Company for damages arising out of mistakes, omissions, interruptions, delays, or errors or defects in transmission, or failures or defects in the Telephone Company equipment occurring in the course of furnishing service or other facilities and not caused by the negligence of the Telephone Company in failing to maintain proper standards of maintenance and operation and to exercise reasonable supervision, shall in no event exceed an amount equivalent to the proportionate charge to the customer for the period of service during which such mistake, omission, interruption, delay, or error or defect in transmission, or failure or defect in the Telephone Company equipment occurs.

2.

(D)

K. Connection With Customer-Provided Audible Indicating Equipment

1. Except as provided for elsewhere in this tariff (especially in Section 23, B.5.), audible indicating equipment provided by a subscriber may be used in connection with the exchange service lines of the Telephone Company operated on a dial or common battery basis, under the conditions stated below.

a. The equipment provided by the subscriber will be connected with the lines of Telephone Company through unattended station equipment furnished by the customer or the Telephone Company, and may be used only for the transmission of audible signals or tones to persons calling the unattended station.

b. The facilities will include the unattended station equipment and an associated telephone station so arranged that the audible indicating equipment will be automatically made inoperative when the associated telephone station is in use.

ISSUED:

BY: I. B. Watson
Vice President - Administration
6666 West 110th Street
Overland Park, Kansas 66211

EFFECTIVE:

RECEIVED

DEC 1 1987

ACCT. & ENGI. DEPARTMENT
Nebr. Public Service Commission

GENERAL EXCHANGE TARIFF

UNITED TELEPHONE COMPANY
OF THE WEST
NEBRASKA

Section 23
Fourth Revised Sheet 16
Canceling Third Revised Sheet 16

CONNECTIONS WITH CERTAIN FACILITIES OF CUSTOMERS

K. Connection With Customer-Provided Audible Indicating Equipment

1. (Cont'd)

- c. Such facilities will be furnished only in connection with nonpublished individual business lines or business private branch exchange lines.

In the event of the use or intention to use unattended station equipment and service at locations where, in the opinion of the Telephone Company, the service cannot satisfactorily be furnished, or for any violation of the regulations of the Telephone Company, the Telephone Company may decline to furnish the service or discontinue service already furnished.

- d. The magnitude and the character of the voltages and currents transmitted from the equipment provided by the subscriber and the operation and maintenance of such equipment shall be such as not to interfere with any of the services offered by the Telephone Company or interfere with others. The equipment provided by the subscriber shall have an operating cycle not to exceed five minutes and its other characteristics shall be such that it will work properly with the unattended station equipment and associated facilities of the Telephone Company, and such that its connection to the lines of the Telephone Company does not interfere with service over other Telephone Company lines, or impair privacy of conversation over such lines.

Such equipment shall be suitable to avoid hazard of damage to Telephone Company plant or of injury to Telephone Company employees or subscribers because of the character or location of subscriber-owned apparatus and of sources of power to which it is connected. In cases in which additional protective equipment is required, this shall be provided by the subscriber or by the Telephone Company at the subscriber's expense.

- e. The Telephone Company may, upon suitable notification to the subscriber, make such tests and inspections as may be necessary to determine that the above requirements are being complied with in the installation, operation and maintenance of the equipment provided by the subscriber. The Telephone Company may interrupt the line if at any time such action should become necessary to protect any of its services because of departure from the above requirements.

ISSUED: May 2, 1983

EFFECTIVE: June 1, 1983

BY: J. T. Cluen
Assistant Vice President -
Revenue Requirements
6666 West 110th Street
Overland Park, Kansas 66211

GENERAL EXCHANGE TARIFF

UNITED TELEPHONE COMPANY
OF THE WEST
NEBRASKA

Section 23
Second Revised Sheet 16A
Cancels First Revised Sheet 16A

CONNECTIONS WITH CERTAIN FACILITIES OF CUSTOMERS

K. CONNECTION WITH CUSTOMER-PROVIDED AUDIBLE INDICATING EQUIPMENT (Cont'd)

1. **Except as provided for elsewhere in this tariff ...** (Cont'd)

(T)

- f. The lines furnished by the Telephone Company are the same as those furnished for general telephone service, and are not represented as adapted to the transmission of signals or tones from the audible indicating equipment provided by the subscriber. The Telephone Company shall not be responsible to the subscriber for damages caused by mistakes, omissions, delays, interruptions, errors, or defects in transmission, except those caused by its negligence in failing to furnish lines proper for general telephone service or in failing to maintain and operate such lines in a manner proper for such service. In no event shall its liability for damages exceed an amount equivalent to the proportionate charge to the subscriber for the period during which interrupted or defective service attributable to such negligence may occur.
- g. The subscriber indemnifies and saves the Telephone Company harmless against claims for infringement of patents arising from combining with, or using in connection with, facilities of the Telephone Company, apparatus and systems of the subscriber; and against all other claims arising out of any act or omission of the subscriber in connection with facilities provided by the Telephone Company.

(D)

L. CONNECTION WITH CUSTOMER-PROVIDED VOICE RECORDING EQUIPMENT

Customer-owned voice recording equipment for the recording of telephone conversations may be used in connection with the facilities of the Telephone Company subject to the following conditions:

- 1. Connection of customer-owned voice recording equipment with the facilities of the Telephone Company shall be made only through recorder-connector equipment which contains a device automatically producing a distinctive recorder tone that is repeated at intervals of approximately fifteen seconds when the recording equipment is in use. The distinctive recorder tone described is not required:
 - a. When used by a Federal Communications Commission licensed broadcast station customer for recording of two-way telephone conversations solely for broadcasting over the air. (Filed in compliance with Memorandum Opinion and Order of Federal Communications Commission adopted December 13, 1972.)

(M)

(M)

(M) Material now appearing on this page previously appeared on Original Sheet 16B.

ISSUED:
June 16, 2009

BY: Darlene Terry
Manager, Tariffs

EFFECTIVE:
June 26, 2009

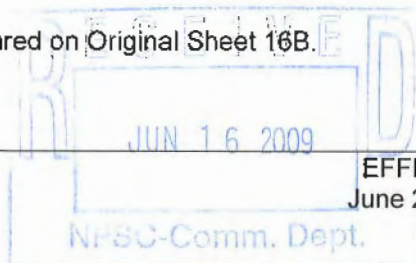

GENERAL EXCHANGE TARIFF

UNITED TELEPHONE COMPANY
OF THE WEST
NEBRASKA

Section 23
First Revised Sheet 16B
Cancels Original Sheet 16B

CONNECTIONS WITH CERTAIN FACILITIES OF CUSTOMERS

This Page is Reserved for Future Use.

(T)

(D)

(M)

(M)

(M) Material previously appearing on this page now appears on Second Revised Sheet 16A.

ISSUED:
June 16, 2009

BY: Darlene Terry
Manager, Tariffs

EFFECTIVE:
June 26, 2009

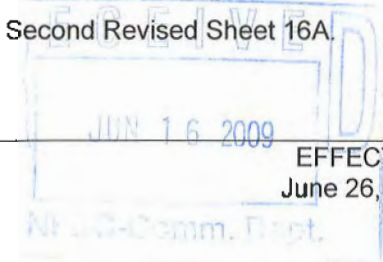

GENERAL EXCHANGE TARIFF

UNITED TELEPHONE COMPANY
OF THE WEST
NEBRASKA

Section 23
Fourth Revised Sheet 17
Cancels Third Revised Sheet 17

CONNECTIONS WITH CERTAIN FACILITIES OF CUSTOMERS

L. CONNECTION WITH CUSTOMER-PROVIDED VOICE RECORDING EQUIPMENT (Cont'd)

1. **Connection of customer-owned voice recording equipment ...** (Cont'd)

(T)

- b. When used by the United States Secret Service of the Dept. of Treasury for recording of two-way telephone conversations which concern the safety and security of the person of the President of the United States, Members of his immediate family, or the White House and its grounds. (Filed in compliance with an Order of the Federal Communications Commission adopted January 22, 1975.)
- c. When used by a broadcast network or by a cooperative programming effort composed exclusively of Federal Communications Commission broadcast licensees to record two-way telephone conversations solely for broadcasting over the air by a licensed broadcast station. (Filed in compliance with an Order of the Federal Communications Commission adopted December 18, 1975.)
- d. When used for recording at United States Dept. of Defense Command Centers of emergency communications transmitted over the Dept. of Defense's private line system when connected to Exchange Telecommunication Service. (Filed in compliance with an Order of the Federal Communication Commission adopted May 19, 1976.)
- e. When recording equipment in connection with public fire and/or police service for recording two-way telephone conversations, provided that proper public authority certifies that the service will be used exclusively for receipt of emergency fire and police calls.
- f. For "incoming calls made to telephone numbers publicized for emergencies and outgoing calls made in immediate response." (Filed in compliance with an Order of the Federal Communications Commission adopted May 18, 1981.)
- g. When "calls are made for patently unlawful purposes such as bomb threats, kidnap ransom requests and obscene telephone calls. Outgoing calls made in immediate response to such a call will also be excepted." (Filed in compliance with an Order of the Federal Communications Commission adopted May 18, 1981.)
- h. When "recordings made pursuant to an explicit and lawful order of a court issued pursuant to" the Federal Wiretap law. (Filed in compliance with an Order of the Federal Communications Commission adopted May 18, 1981.)

ISSUED:
June 16, 2009

BY: Darlene Terry
Manager, Tariffs

EFFECTIVE:
June 26, 2009

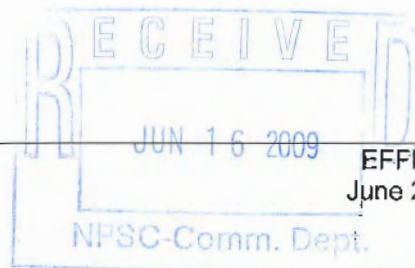

GENERAL EXCHANGE TARIFF

UNITED TELEPHONE COMPANY
OF THE WEST
NEBRASKA

Section 23
Second Revised Sheet 17.1
Cancels First Revised Sheet 17.1

CONNECTIONS WITH CERTAIN FACILITIES OF CUSTOMERS

L. CONNECTION WITH CUSTOMER-PROVIDED VOICE RECORDING EQUIPMENT (Cont'd)

1. **Connection of customer-owned voice recording equipment ...** (Cont'd) (T)
 - i. When private line service which has not connection with the exchange or toll system of the Telephone Company.
2. Customer-provided voice recording equipment may not be connected with Services of the Telephone Company for the recording of two-way telephone conversations by means of an acoustic or indicative connection, except when used as specified in L.1.(a) through (i) preceding.
3. The customer-provided voice recording equipment shall be so arranged that, at the will of the user, it can be physically connected to and disconnected from the services of the Telephone Company, or switched on and off.
4. Permanent connection may be made through recorder-connector equipment furnished, installed, and maintained by the Telephone Company, or voice recording equipment provided by the customer with certified built-in recorder-connector as authorized by the Federal Communications Commission.
5. Telephone service furnished by the Telephone Company is not represented as adapted to the recording of telephone conversations by means of voice recording equipment. The use of customer-owned voice recording equipment in connection with the facilities of the Telephone Company, is permitted only on the condition that the liability of the Telephone Company for damages arising out of mistakes, omissions, interruptions, delays, or errors or defects in transmission, or failures or defects in the recorder-connector equipment, occurring in the course of furnishing service or other facilities, and not caused by the negligence of the customer, or of the Telephone Company in failing to maintain proper standards of maintenance and operation, and to exercise reasonable supervision, shall in no event exceed an amount equivalent to the proportionate charge to the customer for the period of service during which such mistake, omission, interruption, delay, or error or defect in transmission, or failures or defects in the recorder-connector equipment occurs. (M)
(M)

(M) Material now appearing on this page previously appeared on Second Revised Sheet 17.2.

ISSUED:
June 16, 2009

BY: Darlene Terry
Manager, Tariffs

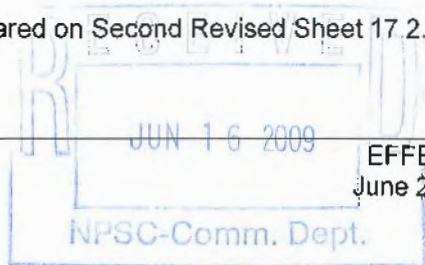

EFFECTIVE:
June 26, 2009

GENERAL EXCHANGE TARIFF

UNITED TELEPHONE COMPANY
OF THE WEST
NEBRASKA

Section 23
Third Revised Sheet 17.2
Cancels Second Revised Sheet 17.2

CONNECTIONS WITH CERTAIN FACILITIES OF CUSTOMERS

L. CONNECTION WITH CUSTOMER-PROVIDED VOICE RECORDING EQUIPMENT (Cont'd)

6. The operating characteristics of the customer-owned voice recording equipment shall be such as not to interfere with any of the services offered by the Telephone Company. Upon notice from the Telephone Company that the equipment of the customer is causing, or is likely to cause, hazard or interference, the customer shall make such changes as may be necessary to remove or prevent such hazard or interference. The customer indemnifies and saves the Telephone Company harmless against claim for libel, slander or infringement of copyright arising from the improper use of material transmitted over its facilities and recorded; against claims for infringement of patents arising from combining with, or using in connection with, facilities of the Telephone Company, apparatus or systems of the facilities of the Telephone Company, apparatus or systems of the customer; and against all other claims arising out of any act or omission of the customer in connection with facilities provided by the Telephone Company.

(M)

(M)

(T)

(D)

M. CONNECTION WITH CUSTOMER-PROVIDED AUTOMATIC ANSWERING AND RECORDING EQUIPMENT

1. **Except** as provided for elsewhere in this tariff (especially in Section 23, B.5.), the connection of customer-provided automatic answering and recording equipment in connection with the facilities of the Telephone Company for transmitting a prerecorded message to the calling party if desired, and recording of an incoming message only, may be made through connecting equipment or using equipment with certified built-in connecting equipment as authorized by the Federal Communications Commission. Such connecting equipment will automatically trip the ring and hold the connection.

(T)

(M1)

(M1)

(M) Material previously appearing on this page now appears on Second Revised Sheet 17.1.

(M1) Material now appearing on this page previously appeared on Fourth Revised Sheet 18.

ISSUED:
June 16, 2009

BY: Darlene Terry
Manager, Tariffs

EFFECTIVE:
June 26, 2009

GENERAL EXCHANGE TARIFF

UNITED TELEPHONE COMPANY
OF THE WEST
NEBRASKA

Section 23
Fifth Revised Sheet 18
Cancels Fourth Revised Sheet 18

CONNECTIONS WITH CERTAIN FACILITIES OF CUSTOMERS

M. CONNECTION WITH CUSTOMER-PROVIDED AUTOMATIC ANSWERING AND RECORDING EQUIPMENT

- (D)
- (D)
- (M)
- (M)
- 2. Automatic answering equipment for transmitting the prerecorded message may be provided by the customer. (T)
- 3. Automatic answering and automatic answering and recording services are available for use with all exchange and private branch exchange stations where individual ringing is employed. (T)
- (D)
- 4. Telephone service furnished by the Telephone Company is not represented as adapted to the recording of telephone conversations by means of voice recording equipment. The use of customer-owned voice recording equipment in connection with the facilities of the Telephone Company, is permitted only on the condition that the liability of the Telephone Company for damages arising out of mistakes, omissions, interruptions, delays, or errors or defects in transmission, or failures or defects in the recorder-connector equipment, occurring in the course of furnishing service or other facilities, and not caused by the negligence of the customer, or of the Telephone Company in failing to maintain proper standards of maintenance and operation, and to exercise reasonable supervision, shall in no event exceed an amount equivalent to the proportionate charge to the customer for the period of service during which such mistakes, omissions, interruption, delays, or errors or defects in transmission, or failures or defects in the recorder-connector equipment occur. (T)

(M) Material previously appearing on this page now appears on Third Revised Sheet 17.2.

ISSUED:
June 16, 2009

BY: Darlene Terry
Manager, Tariffs

EFFECTIVE:
June 26, 2009

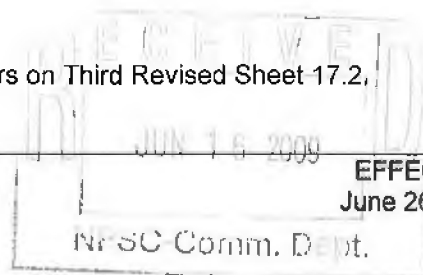

GENERAL EXCHANGE TARIFF

UNITED TELEPHONE COMPANY
OF THE WEST
NEBRASKA

Section 23
Fifth Revised Sheet 19
Cancels Fourth Revised Sheet 19

CONNECTIONS WITH CERTAIN FACILITIES OF CUSTOMERS

M. CONNECTION WITH CUSTOMER-PROVIDED AUTOMATIC ANSWERING AND RECORDING EQUIPMENT

5. The operating characteristics of the customer-owned voice recording equipment shall be such as not to interfere with any of the services offered by the Telephone Company. Upon notice from the Telephone Company that the equipment of the customer is causing, or is likely to cause, hazard or interference, the customer shall make such changes as may be necessary to remove or prevent such hazard or interference. The customer indemnifies and saves the Telephone Company harmless against claim for libel, slander or infringement of copyright arising from the improper use of material transmitted over its facilities and recorded; against claims for infringement of patents arising from combining with, or using in connection with, facilities of the Telephone Company, apparatus or systems of the customer; and against all other claims arising out of any act or omission of the customer in connection with facilities provided by the Telephone Company.

(D)

(T)

(D)

N. CONNECTION WITH CUSTOMER-PROVIDED SPECIALTY TELEPHONES

1. Except as provided for elsewhere in this tariff (especially in Section 23, B.5.), the connection of customer-provided specialty telephones will be in accordance with the following provisions:
- a. Specialty telephones are custom designed instruments of antique or continental appearance or ones which differ significantly in design and appearance from standard telephone instruments.
- b. The operating characteristics of the customer-owned specialty telephones shall be such that the equipment will function properly with the facilities of the Telephone Company and will not interfere with any of the services offered by the Telephone Company. Upon notice from the Telephone Company that the equipment of the customer is causing, or is likely to cause, hazard or interference, the customer shall make such changes as may be necessary to remove or prevent such hazard or interference.

(M)

(M)

(M) Material now appearing on this page previously appeared on First Revised Sheet 19A.

ISSUED:
June 16, 2009

BY: Darlene Terry
Manager, Tariffs

EFFECTIVE:
June 26, 2009

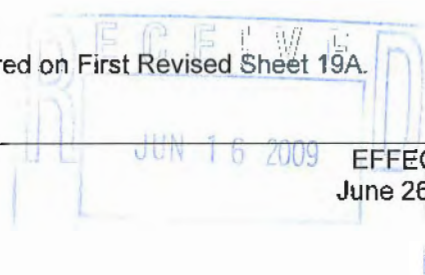

GENERAL EXCHANGE TARIFF

UNITED TELEPHONE COMPANY
OF THE WEST
NEBRASKA

Section 23
Second Revised Sheet 19A
Cancels First Revised Sheet 19A

CONNECTIONS WITH CERTAIN FACILITIES OF CUSTOMERS

This Page is Reserved for Future Use

(T)
(D)
(D)
(M)
|
(M)

(M) Material previously appearing on this page now appears on Fifth Revised Sheet 19.

ISSUED:
June 16, 2009

BY: Darlene Terry
Manager, Tariffs

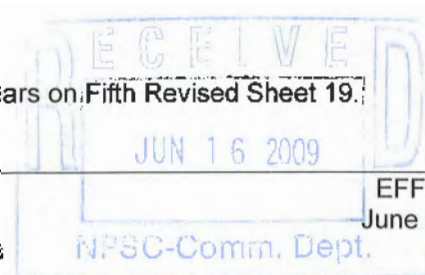

EFFECTIVE:
June 23, 2009

GENERAL EXCHANGE TARIFF

UNITED TELEPHONE COMPANY
OF THE WEST
NEBRASKA

Section 23
First Revised Sheet 19A
Canceling Original Sheet 19A

CONNECTIONS WITH CERTAIN FACILITIES OF CUSTOMERS

N. Connection With Customer-Provided Specialty Telephones (Cont'd) (T)

1. (Cont'd)

b. (Cont'd)

hazard or interference, the customer shall make such changes as may be necessary to remove or prevent such hazard or interference.

(D)
|
(D)

ISSUED: July 15, 1986

BY: I. B. Watson
Vice President - Administration
6666 West 110th Street
Overland Park, Kansas 66211

EFFECTIVE: August 1, 1986
Docket No. C-574

GENERAL EXCHANGE TARIFF

UNITED TELEPHONE COMPANY
OF THE WEST
NEBRASKA

Section 23
Second Revised Sheet 20
Canceling First Revised Sheet 20

CONNECTIONS WITH CERTAIN FACILITIES OF CUSTOMERS

0. NETWORK PROTECTION CRITERIA

To protect the telecommunications network and the services furnished to the general public by the Telephone Company from harmful effects, the signal from the customer-provided communications system to the long distance message telecommunications network must comply with the following minimum network protection criteria: except where otherwise specified in this tariff;

1. Where the customer-provided communications system is connected with long distance message telecommunications service through an arrangement and network control signaling unit, the customer-provided communications system must comply with the following criteria: (C)
 - a. To prevent excessive noise and crosstalk in the network, it is necessary that the power of the signal at the central office not exceed 12db below one milliwatt when averaged over any three second interval. To permit each customer, independent of distance from the central office, to supply signal power which approximates the 12db below one milliwatt limit at the central office, the power of the signal which may be applied by the customer-provided equipment to the Company interface located on the customer's premises will be specified for each customer's location, but in no case shall it exceed one milliwatt.
 - b. To protect other services it is necessary that the signal which is applied by the customer-provided equipment to the Company interface located on the customer's premises meets the following limits:
 - (1) The power in the band from 3,995 Hertz to 4,005 Hertz shall be at least 18db below the power of the signal as specified in 0.1.a. above.
 - (2) The power in the band from 4,000 Hertz to 10,000 Hertz shall not exceed 16db below one milliwatt.
 - (3) The power in the band from 10,000 Hertz to 25,000 Hertz shall not exceed 24db below one milliwatt.
 - (4) The power in the band from 25,000 Hertz to 40,000 Hertz shall not exceed 36db below one milliwatt.

ISSUED:

BY: I. B. Watson
Vice President - Administration
6666 West 110th Street
Overland Park, Kansas 66211

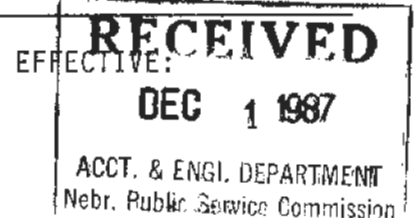

GENERAL EXCHANGE TARIFF

UNITED TELEPHONE COMPANY
OF THE WEST
NEBRASKA

Section 23

Original Sheet 20A

CONNECTIONS WITH CERTAIN FACILITIES OF CUSTOMERS

0. NETWORK PROTECTION CRITERIA (Cont'd)

1. (Cont'd)

(L)

b. (Cont'd)

(5) The power in the band above 40,000 Hertz shall not exceed 50db below one milliwatt.

c. To prevent the interruption or disconnection of a call, or interference with network control signaling, it is necessary that the signal applied by the customer-provided equipment to the Company interface located on the customer's premises at no time have energy solely in the 2450 to 2750 Hertz band. If signal power is in the 2450 to 2750 Hertz band, it must not exceed the power present at the same time in the 800 to 2450 Hertz band.

2. Where the customer-provided communications system is connected with long distance message telecommunications service through customer-provided equipment which affects such connections externally to a network control signaling unit by means of an acoustic or inductive connection for transmitting and/or receiving the customer-provided communications system must comply with the following criteria:

a. To prevent excessive noise and crosstalk in the network it is necessary that the power of the signal which is applied by the customer-provided equipment to the network control signaling unit located on the customer's premises be limited so that the

(L)

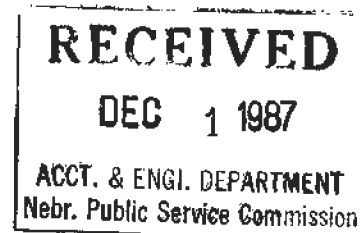

ISSUED:

BY: I. B. Watson
Vice President - Administration
6666 West 110th Street
Overland Park, Kansas 66211

EFFECTIVE:

GENERAL EXCHANGE TARIFF

UNITED TELEPHONE COMPANY
OF THE WEST
NEBRASKA

Section 23
Second Revised Sheet 21
Canceling First Revised Sheet 21

CONNECTIONS WITH CERTAIN FACILITIES OF CUSTOMERS

0. NETWORK PROTECTION CRITERIA (Cont'd)

2. (Cont'd)

a. (Cont'd)

signal power at the output of the network control signaling unit (i.e., at the input of the Telephone Company line) does not exceed 9db below one milliwatt when averaged over any three second interval.

b. To protect other services it is necessary that the signal which is applied by the customer-provided equipment to the network control signaling unit located on the customer's premises meet the following limits at the output of the network control signaling unit (i.e., at the input to the Telephone Company line);

(1) The power in the band from 3,995 Hertz to 4,005 Hertz shall be at least 18db below the power of the signal as specified in 0.1.a. above.

(2) The power in the band from 4,000 Hertz to 10,000 Hertz shall not exceed 16db below one milliwatt.

(3) The power in the band from 10,000 Hertz to 25,000 Hertz shall not exceed 24db below one milliwatt.

(4) The power in the band from 25,000 Hertz to 40,000 Hertz shall not exceed 36db below one milliwatt.

(5) The power in the band above 40,000 Hertz shall not exceed 50db below one milliwatt.

c. To prevent the interruption or disconnection of a call, or interference with network control signaling, it is necessary that the signal applied by the customer-provided equipment to the network control signaling unit located on the customer's premises be limited so that the signal at the output of the network control signaling unit located on the customer's premises (i.e., at the input to the Telephone Company line) shall at no time have energy solely in the 2450 to 2750 Hertz band. If there is signal power at the output of the network control signaling unit in the 2450 to 2750 Hertz band, it must not exceed the power present at the same time in the 800 to 2450 Hertz band.

(T)

RECEIVED

DEC 1 1987

ACCT & ENGL. DEPARTMENT
of the Public Service Commission

ISSUED:

BY: I. B. Watson
Vice President - Administration
6666 West 110th Street
Overland Park, Kansas 66211

EFFECTIVE:

GENERAL EXCHANGE TARIFF

UNITED TELEPHONE COMPANY
OF THE WEST
NEBRASKA

Section 23

Original Sheet 22

CONNECTIONS WITH CERTAIN FACILITIES OF CUSTOMERS

P. Connection With Customer-Provided Customer Premise Inside Wire

1. The connection of customer-provided customer premise inside wire will be in accordance with the following regulations:
 - (a) Customer premise inside wire provided by the customer shall be connected to the access line service furnished by the Company at the demarcation point; the network interface device if one is present; or at any Company-provided miniature modular standard jack located elsewhere on the premises.
 - (b) Customer premise inside wire provided by the customer must be installed in accordance with the technical standards and installation guidelines furnished to the Commission by the Company.
 - (c) When practical, the Telephone Company will install the network interface device on the exterior of the customer's premises. If placed within the customer's premises, the Telephone Company will determine the location giving attention to the need for the customer to have access to the device. If the customer requests an alternative to the location selected by the Telephone Company for installation of the network interface device, the customer shall be responsible for any additional costs incurred to accommodate the request.
 - (d) The Telephone Company is not responsible for the maintenance or operation of customer-provided customer premise inside wire.
 - (e) Customers connecting or altering customer premise inside wire shall, upon request of the Telephone Company provide the following information to the Telephone Company: (1) the responsible customer's telephone number(s); (2) a description of the location of the jack to which the premise wiring is to be connected; (3) a statement that all applicable rules, building codes and electrical codes will be complied with; and (4) the wire manufacturer, or brand name, and model number, if any, of the wire used.

ISSUED: February 3, 1987

BY: I. B. Watson
Vice President - Administration
6666 West 110th Street
Overland Park, Kansas 66211

EFFECTIVE: February 3, 1987
Docket No. C-658

GENERAL EXCHANGE TARIFF

UNITED TELEPHONE COMPANY
OF THE WEST
NEBRASKA

Section 23
Original Sheet 23

CONNECTIONS WITH CERTAIN FACILITIES OF CUSTOMERS

P. Connection with Customer-Provided Customer Premise Inside Wire (Cont'd)

1. (Cont'd)

- f. In the event the customer maintains or attempts to maintain customer premise inside wire or alters, installs, connects, refigures or removes any customer premise inside wire, the customer assumes the risk of loss of service, damage to property, or death or injury of the customer or the customer's agent. The customer will save the Company harmless from any and all liability, claims, or damage suits arising out of the customer's customer premise inside wire activity.
- g. In those instances where the Company makes a repair visit to the customer's premise and the service difficulty or trouble is found to be a result of customer-provided premise wire that is not installed in accordance with the technical standards for such wire, the customer shall be responsible for the payment of the maintenance of service charge.

2. Non-Compliance With Regulations

- a. Where customer-provided inside wire is found to be in non-compliance with the technical standards and installation guidelines of this tariff, the Company will promptly notify the customer of the non-compliance and will take such immediate action, including immediate suspension of service, as is necessary for the protection of the telecommunications network and Company employees.
- b. Within ten days of receipt of such notice, the customer shall discontinue use of the customer-provided inside wire or correct the non-compliance and notify the Company in writing that the violation has been corrected.
- c. Failure of the customer to discontinue such use or to correct the non-compliance within ten days will result in the suspension of the customer's service, if not already suspended, until such time as the customer complies with the provisions of this tariff.

ISSUED: February 3, 1987

BY: I. B. Watson
Vice President - Administration
6666 West 110th Street
Overland Park, Kansas 66211

EFFECTIVE: February 3, 1987
Docket No. C-658

GENERAL EXCHANGE TARIFF

UNITED TELEPHONE COMPANY
OF THE WEST d/b/a CenturyLink
NEBRASKA

Section 24
Third Revised Sheet 1
Cancels Second Revised Sheet 1

RESERVED FOR FUTURE USE

(C)

(D)

(D)

Handwritten signature

NOV 2018

Handwritten signature

ISSUED:
November 30, 2018

BY: Darlene Terry
Manager, Tariffs

EFFECTIVE:
December 10, 2018

GENERAL EXCHANGE TARIFF

UNITED TELEPHONE COMPANY
OF THE WEST
NEBRASKA

Section 25
Fifth Revised Sheet 1
Cancels Fourth Revised Sheet 1

FOREIGN EXCHANGE SERVICE (BUSINESS ONLY)

(C)

A. GENERAL REGULATIONS:

1. Foreign exchange service is interexchange service furnished to a subscriber from a central office in an exchange other than the one that normally serves the area in which the subscriber is located.
2. For the purpose of this tariff the term "Foreign Exchange" means the exchange providing central office dial tone for the foreign exchange service ordered. The term "Normal Exchange" means the exchange in which the customer's premises is located and in which service is provided. The term "Interexchange Channel" designates that portion of the foreign exchange service circuit which is provided between the toll rate centers of the foreign and normal exchanges.
3. Foreign exchange service does not come within the Telephone Company's general undertaking, nor does the Telephone Company obligate itself to furnish such service generally; but, will do so, at its option, where facilities of such a character are available as will permit satisfactory telephone transmission, and where the service is warranted by the circumstances involved.
4. Foreign exchange service may be provided only in connection with private branch exchange trunk lines, individual line **business service**, two way dial repeating tie lines, off premise PBX stations in an exchange with access to the central office network of another exchange; or other services which provide access directly or indirectly to the central office network of another exchange. The service will be furnished only at one location or premises for each channel or circuit. (C)
5. Where the normal exchange is operated by this Telephone Company, foreign exchange service is furnished only on the condition that the applicant is a subscriber to individual line **business service**, or private branch exchange service, in the normal exchange, and at the same location where such service is proposed to be installed. Under this condition, when a foreign exchange service subscriber discontinues normal exchange service, the normal exchange shall immediately notify such foreign exchange subscriber and foreign exchange business office, that the foreign exchange service may be discontinued ten (10) days thereafter. (C)
6. Where the foreign exchange is operated by another telephone company, foreign exchange service will be provided only when satisfactory arrangements can be negotiated with such company to furnish a portion of the necessary facilities.



ISSUED:
October 22, 2008

BY: Darlene Terry
Manager, Tariffs

EFFECTIVE:
November 1, 2008

GENERAL EXCHANGE TARIFF

UNITED TELEPHONE COMPANY
OF THE WEST
NEBRASKA

Section 25
Fifth Revised Sheet 2
Cancels Fourth Revised Sheet 2

FOREIGN EXCHANGE SERVICE (**BUSINESS ONLY**)

A. GENERAL REGULATIONS (Cont'd):

7. Foreign exchange service will be furnished provided the necessary facilities and equipment are available. Where the facilities and/or equipment are not available, and extraordinary facility costs, equipment costs, special operating expenses, and/or other special considerations are incurred in making such service available, the subscriber may be required to pay an additional charge to cover all or a portion of such unusual expenses, or be required to contract for service beyond the initial period, or both.
8. The use of the service is limited to the subscriber and his employees for business **purposes**. **Foreign** exchange service calls will be further limited to calls to other stations of the foreign exchange. If any subscriber to this service is found to be transferring or transmitting messages for parties other than authorized above, in the normal exchange area, and/or making toll calls through the foreign exchange, such subscriber and foreign exchange business office shall be notified that the practice must be discontinued or the foreign exchange service may be terminated ten (10) days after the date of such notice.

(C)



ISSUED:
October 22, 2008

BY: Darlene Terry
Manager, Tariffs

EFFECTIVE:
November 1, 2008

GENERAL EXCHANGE TARIFF

UNITED TELEPHONE COMPANY
OF THE WEST
NEBRASKA

Section 25
Second Revised Sheet 2A
Cancels First Revised Sheet 2A

FOREIGN EXCHANGE SERVICE (**BUSINESS ONLY**)

(C)

A. GENERAL REGULATIONS (Cont'd):

11. Customer-provided terminal equipment or customer-provided communication systems attached or connected to the facilities of this Company and permitted to be used under this Tariff may not be used for the Local Exchange service of this Company unless there is compliance with provisions of the Local and General Exchange Tariff of this Company.

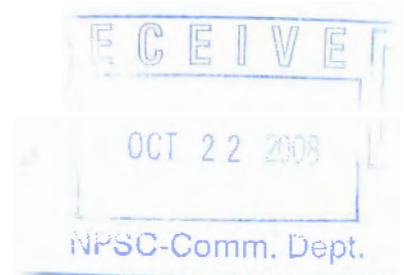

ISSUED:
October 22, 2008

BY: Darlene Terry
Manager, Tariffs

EFFECTIVE:
November 1, 2008

GENERAL EXCHANGE TARIFF

UNITED TELEPHONE COMPANY
OF THE WEST
NEBRASKA

Section 25
Fifth Revised Sheet 3
Cancels Fourth Revised Sheet 3
And Cancels Second Revised Sheet 4

FOREIGN EXCHANGE SERVICE (**BUSINESS ONLY**)

(C)

B. RATES:

1. The charge for foreign exchange service is the established monthly access line rate, and any non-recurring service connection charges of the foreign exchange, for the grade of service (individual line **business, or** PBX and PABX trunks) with which the foreign exchange service is to be associated. (C)
2. Interexchange mileage charges are applicable in addition to the established monthly access line rate of the serving exchange. Interexchange mileage is measured through the use of the V and H coordinates between rate centers of the exchanges involved
3. The appropriate Interexchange Mileage Charges (both fixed and V and H mileage) and the Service Termination Charge apply. These charges are located in the United Telephone Company of the West - Nebraska Access Service Tariff, Section 7.2.3 and Price List 1.4.2, "Voice Grade Service."
4. Where all or a portion of the interexchange channel facilities are furnished by another telephone company, charges shall apply to such interexchange channel facilities as specified in the regulations of such participating company, for the portion of their interexchange channel provided.



ISSUED:
October 22, 2008

BY: Darlene Terry
Manager, Tariffs

EFFECTIVE:
November 1, 2008

GENERAL EXCHANGE TARIFF

UNITED TELEPHONE COMPANY
OF THE WEST
NEBRASKA

Section 25
Second Revised Sheet 4
Canceling First Revised Sheet 4

FOREIGN EXCHANGE SERVICE (Cont'd)

B. RATES: (Cont'd)

(D)
|
(D)
|
(D)
|
(D)

RECEIVED

DEC 23 1989

ACCT. & ENGI. DEPARTMENT
Nebr. Public Service Commission

ISSUED: December 22, 1989

EFFECTIVE: January 1, 1990

BY: I. B. Watson
Vice President - Administration
5454 West 110th Street
Overland Park, Kansas 66211

GENERAL EXCHANGE TARIFF

UNITED TELEPHONE COMPANY
OF THE WEST
NEBRASKA

Section 26
Fourth Revised Sheet 1
Canceling Third Revised Sheet 1

This section is being canceled due to the sale of all mobile telephone and paging equipment to a miscellaneous common carrier. These services will no longer be provided by United Telephone Company of the West.

This sheet also cancels the following sheets:

Second Revised Sheet 2
First Revised Sheet 3
Second Revised Sheet 4
First Revised Sheet 5
Second Revised Sheet 6
Third Revised Sheet 7
Third Revised Sheet 8
Second Revised Sheet 9
First Revised Sheet 10

ISSUED: June 10, 1986

EFFECTIVE: June 10, 1986

BY: I. B. Watson
Vice President - Administration
6666 West 110th Street
Overland Park, Kansas 6621

Docket-C-649

GENERAL EXCHANGE TARIFF

UNITED TELEPHONE COMPANY
OF THE WEST
NEBRASKA

Section 27
Twelfth Revised Sheet 1
Cancels Eleventh Revised Sheet 1

PRIVATE LINE SERVICES AND CHANNELS

A. GENERAL

1. Private lines are circuits provided by the Telephone Company for communication which is not intended for connection with exchange service. Private lines may be between points within an exchange or between exchanges.
2. Private lines between points within an exchange are furnished at the rates and charges specified herein only where facilities are available; where facilities are not available, the service may be provided at the Company's option under special arrangement and agreement. The rates and charges specified herein will apply to new facilities or additions to existing facilities.
3. Private lines furnished between exchanges (Interexchange Private Line Service) are provided under the regulations, rates, and charges of United Telephone Company of the West - Nebraska Access Service Tariff.

(D)
—
(D)

B. REGULATIONS

1. All instruments and apparatus used in connection with private lines and not supplied by the Telephone Company must be of a type approved by the Telephone Company and the FCC.
2. Where the private line is to be used for signaling or use other than voice communication, the current to be applied on the facilities must meet the Telephone Company's general requirements.

C. RATES

1. For Intraexchange mileage charges for Tie Lines, Off-Premise Extension Lines, Signal Loops, Alarm Loops, Control Loops, Music Loops, etc., refer to Section 8 of this tariff.

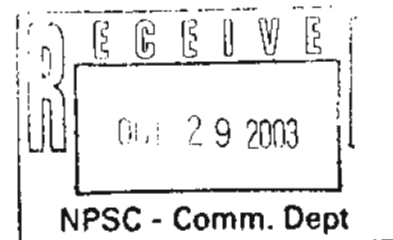

(D)

ISSUED:
October 29, 2003

BY: Warren D. Hannah
Director, Tariffs

EFFECTIVE:
November 10, 2003

GENERAL EXCHANGE TARIFF

UNITED TELEPHONE COMPANY
OF THE WEST
NEBRASKA

Section 27
Tenth Revised Sheet 2
Canceling Ninth Revised Sheet 2

PRIVATE LINE SERVICES AND CHANNELS (Cont'd)

2.

3.

(D)

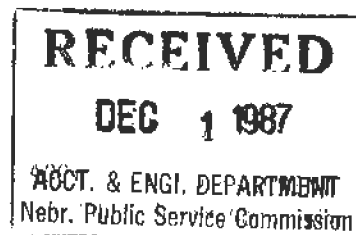

(Information previously located in this section has been moved to Section 8.)

ISSUED:

BY: I. B. Watson
Vice President - Administration
6666 West 110th Street
Overland Park, Kansas 66211

EFFECTIVE:

GENERAL EXCHANGE TARIFF

UNITED TELEPHONE COMPANY
OF THE WEST
NEBRASKA

Section 27
First Revised Sheet 2A
Canceling Original Sheet 2A

RESERVED FOR FUTURE USE

ISSUED: **SEP 18 1984**

BY: I. B. Watson
Vice President - Administration
6666 West 110th Street
Overland Park, Kansas 66211

EFFECTIVE: **NOV 07 1984**

GENERAL EXCHANGE TARIFF

UNITED TELEPHONE COMPANY
OF THE WEST
NEBRASKA

Section 27
First Revised Sheet 3
Canceling Original Sheet 3

PRIVATE LINE SERVICE

C. CONNECTIONS

1. Connections with Certain Facilities of Customers

a. Entrance Facilities

Descriptions

Channels for use with customer-provided channels to extend the customer-provided channels to a service point of the customer. Channels are furnished for half-duplex or duplex operation on a two-point basis for a minimum period of one month.

Approximate bandwidth of 300-3000 cycles per second. Furnished to extend customer-provided communication channels to a service point of the customer.

Regulations

In additions to the other regulations set forth in this "General Regulations" sections, the following regulations apply to entrance facilities.

These channels are furnished to extend a customer-provided communications channel, voice grade or less, to a customer service point (1) within an exchange, or (2) located 25 airline miles or less from the point at which the customer-provided communications channel is connected to the Telephone Company entrance facility.

Connection of Customer-Provided Terminal Equipment or Communications Systems to Telephone Company Entrance Facilities

- (1) Customer-provided communications channels may be connected with Entrance Facilities furnished by the Telephone Company for the purpose of extending the customer-provided communications channels to a service point of the customer. The connection shall be made through a connecting arrangement provided by the customer. The customer-provided channels shall comply with the minimum protection criteria in (3) (a) following. (C)
(C)

ISSUED: May 2, 1983

EFFECTIVE: June 1, 1983

BY: J. T. Cluen
Assistant Vice President -
Revenue Requirements
6666 West 110th Street
Overland Park, Kansas 66211

GENERAL EXCHANGE TARIFF

UNITED TELEPHONE COMPANY
OF THE WEST
NEBRASKA

Section 27
Original Sheet 3a

PRIVATE LINE SERVICE

C. Connections (Cont'd)

1. Connections with Certain Facilities of Customers (Cont'd)

a. Entrance Facilities (Cont'd)

(2) Entrance facilities may be connected at a customer service point to customer-provided transmitting and receiving terminal equipment or to customer-provided communications systems for the purpose of communicating with transmitting and receiving terminal equipment located on the premises on which the service point is located. The connection shall be through connecting arrangements furnished by the customer. The customer-provided terminal equipment or communications systems shall comply with the minimum protection criteria in (3) (a) following. (C)

(3) To protect Telephone Company facilities and the services furnished to the general public by the Telephone Company from harmful effects, the signals applied to Telephone Company facilities by customer-provided terminal equipment or communications systems, must comply with the following minimum protection criteria.

(a) Where customer-provided communications channels are connected to entrance facilities for the purpose of extending the customer-provided channel to a service point of the customer, the following minimum protection criteria apply:

ISSUED: May 2, 1983

EFFECTIVE: June 1, 1983

BY: J. T. Cluen
Assistant Vice President -
Revenue Requirements
6666 West 110th Street
Overland Park, Kansas 66211

GENERAL EXCHANGE TARIFF

UNITED TELEPHONE COMPANY
OF THE WEST
NEBRASKA

Section 27
First Revised Sheet 6
Canceling Original Sheet 6

PRIVATE LINE SERVICE

C. Connections (Cont'd)

1. Connections with Certain Facilities of Customers (Cont'd)

a. Entrance Facilities (Cont'd)

(3) (Cont'd)

(b) (Cont'd)

(2) (Cont'd)

(iv) The power in the band from 25,000 cycles per second to 40,000 cycles per second shall not exceed 36db below one milliwatt.

(v) The power in the band above 40,000 cycles per second shall not exceed 50db below one milliwatt.

(3) Where there is connection to a local or long distance message telecommunications central office line, to prevent the interruption or disconnection of a call, or interference with network control signaling, it is necessary that the signal applied by the customer-provided terminal equipment or communication system to the Telephone Company interface located on the customer's premises at no time have energy solely in the 2450 to 2750 cycles per second band. If signal power is in the 2450 to 2750 cycles per second band, it must not exceed the power present at the same time in the 800 to 2450 cycles per second band.

(c) Rates and Charges - Monthly Service

Special charges based on cost are applied for entrance facilities on a case by case basis.

ISSUED- May 2, 1983

EFFECTIVE: June 1, 1983

BY: J. T. Cluen
Assistant Vice President -
Revenue Requirements
6666 West 110th Street
Overland Park, Kansas 66211

GENERAL EXCHANGE TARIFF

UNITED TELEPHONE COMPANY
OF THE WEST
NEBRASKA

Section 27
Original Sheet 6a

PRIVATE LINE SERVICE

C. Connections (Cont'd)

1. Connections with Certain Facilities of Customers (Cont'd)

b. Definitions

Communications Systems

The term "Communications Systems" denotes channels and other facilities which are capable of two-way communications between customer-provided terminal equipment or Telephone Company stations.

Connecting Arrangement

The term "Connecting Arrangement" denotes the equipment enabling the direct electrical connection of customer-provided facilities with the facilities of the Telephone Company, or the direct electrical connection of Telephone Company facilities. (C)
(C)

ISSUED: May 2, 1983

BY: J. T. Cluen
Assistant Vice President -
Revenue Requirements
6666 West 110th Street
Overland Park, Kansas 66211

EFFECTIVE: June 1, 1983

GENERAL EXCHANGE TARIFF

UNITED TELEPHONE COMPANY
OF THE WEST
NEBRASKA

Section 27
Second Revised Sheet 7
Canceling First Revised Sheet 7

PRIVATE LINE SERVICE

C. CONNECTIONS (Cont'd)

1. Connections with Certain Facilities of Customers (Cont'd)

b. Definitions (Cont'd)

Contract

The term "Contract" refers to the service agreement between a customer and the Telephone Company under which facilities for communication between specified locations, for designated periods, and for the use of the customer specifically named in the contract are furnished in accordance with the provisions of this tariff.

Customer-Provided Terminal Equipment

The term "Customer-Provided Terminal Equipment" denotes devices, apparatus and their associated wiring, provided by a customer for use with facilities furnished by the Telephone Company for private line service and does not include customer-provided communications systems.

Network Control Signaling

The term "Network Control Signaling" denotes the transmission of signals used in the telecommunications system which perform functions such as supervision (control, status, and charging signals), address signaling (e.g., dialing), calling and called number identification, audible tone signals (call progress signals indicating reorder or busy conditions, alerting, coin denominations, coin collect and coin return tones) to control the operation of switching machines in the telecommunications systems.

Network Control Signaling Unit

The term "Network Control Signaling Unit" denotes the equipment used for the provision of network control signaling. (C)

Service Point

The term "Service Point" when used in connection with customer-provided communication channels denotes the point on the customer's premises where channels provided by or furnished to the customer are terminated in transmitting and receiving terminal equipment or in switching equipment used, at least in part, for communications with stations or customer-provided terminal equipment located on the premises.

ISSUED:

BY: I. B. Watson
Vice President - Administration
6666 West 110th Street
Overland Park, Kansas 66211

EFFECTIVE:

RECEIVED

DEC 1 1987

ACCT. & ENGR. DEPARTMENT
Nebr. Public Service Commission

GENERAL EXCHANGE TARIFF

UNITED TELEPHONE COMPANY
OF THE WEST
NEBRASKA

Section 27
First Revised Sheet 8
Cancels Original Sheet 8

PRIVATE LINE SERVICES AND CHANNELS

(D)

Lightlink® Service is now in Section 28.

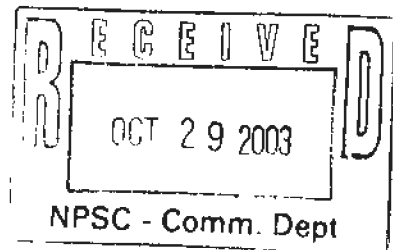

(D)

(N)

ISSUED:
October 29, 2003

BY: Warren D. Hannah
Director, Tariffs

EFFECTIVE:
November 10, 2003

GENERAL EXCHANGE TARIFF

UNITED TELEPHONE COMPANY
OF THE WEST
NEBRASKA

Section 27
First Revised Sheet 9
Cancels Original Sheet 9

PRIVATE LINE SERVICES AND CHANNELS

(D)

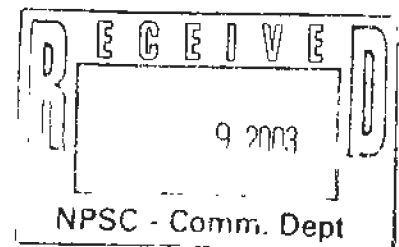

(D)

ISSUED:
October 29, 2003

BY: Warren D. Hannah
Director, Tariffs

EFFECTIVE:
November 10, 2003

GENERAL EXCHANGE TARIFF

UNITED TELEPHONE COMPANY
OF THE WEST
NEBRASKA

Section 27
First Revised Sheet 10
Cancels Original Sheet 10

PRIVATE LINE SERVICES AND CHANNELS

(D)

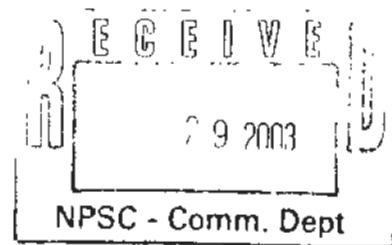

(D)

ISSUED:
October 29, 2003

BY: Warren D. Hannah
Director, Tariffs

EFFECTIVE:
November 10, 2003

GENERAL EXCHANGE TARIFF

UNITED TELEPHONE COMPANY
OF THE WEST
NEBRASKA

Section 27
First Revised Sheet 11
Cancels Original Sheet 11

PRIVATE LINE SERVICES AND CHANNELS

(D)

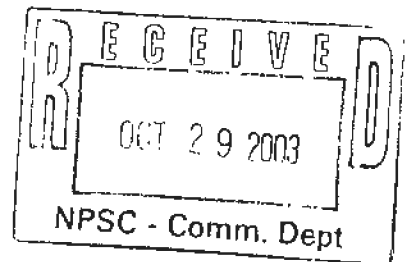

(D)

ISSUED:
October 29, 2003

BY: Warren D. Hannah
Director, Tariffs

EFFECTIVE:
November 10, 2003

GENERAL EXCHANGE TARIFF

UNITED TELEPHONE COMPANY
OF THE WEST
NEBRASKA

Section 27
First Revised Sheet 12
Cancels Original Sheet 12

PRIVATE LINE SERVICES AND CHANNELS

(D)

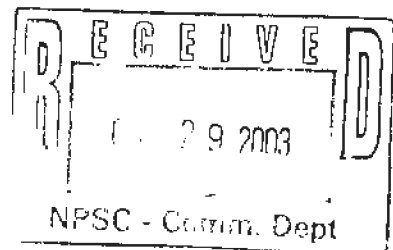

(D)

ISSUED:
October 29, 2003

BY: Warren D. Hannah
Director, Tariffs

EFFECTIVE:
November 10, 2003

GENERAL EXCHANGE TARIFF

UNITED TELEPHONE COMPANY
OF THE WEST
NEBRASKA

Section 27
First Revised Sheet 13
Cancels Original Sheet 13

PRIVATE LINE SERVICES AND CHANNELS

(D)

(D)

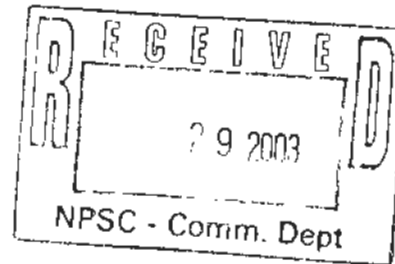

ISSUED:
October 29, 2003

BY: Warren D. Hannah
Director, Tariffs

EFFECTIVE:
November 10, 2003

GENERAL EXCHANGE TARIFF

UNITED TELEPHONE COMPANY
OF THE WEST
NEBRASKA

Section 27
First Revised Sheet 14
Cancels Original Sheet 14

PRIVATE LINE SERVICES AND CHANNELS

(D)

(D)

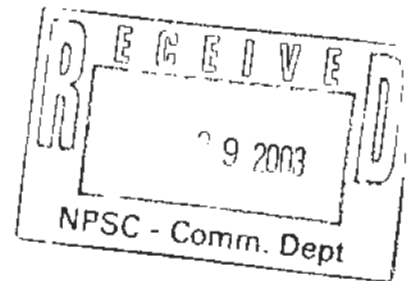

ISSUED:
October 29, 2003

BY: Warren D. Hannah
Director, Tariffs

EFFECTIVE:
November 10, 2003

GENERAL EXCHANGE TARIFF

UNITED TELEPHONE COMPANY
OF THE WEST
NEBRASKA

Section 27
First Revised Sheet 15
Cancels Original Sheet 15

PRIVATE LINE SERVICES AND CHANNELS

1

(D)

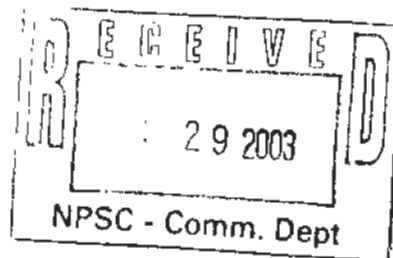

(D)

ISSUED:
October 29, 2003

BY: Warren D. Hannah
Director, Tariffs

EFFECTIVE:
November 10, 2003

GENERAL EXCHANGE TARIFF

UNITED TELEPHONE COMPANY
OF THE WEST
NEBRASKA

Section 27
First Revised Sheet 16
Cancels Original Sheet 16

PRIVATE LINE SERVICES AND CHANNELS

(D)

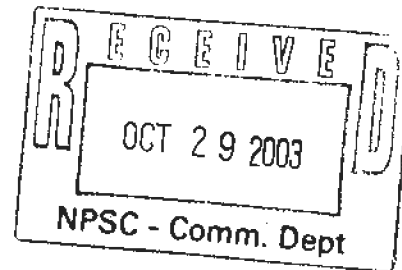

(D)

ISSUED:
October 29, 2003

BY: Warren D. Hannah
Director, Tariffs

EFFECTIVE:
November 10, 2003

GENERAL EXCHANGE TARIFF

UNITED TELEPHONE COMPANY
OF THE WEST
NEBRASKA

Section 27
First Revised Sheet 17
Cancels Original Sheet 17

PRIVATE LINE SERVICES AND CHANNELS

(D)

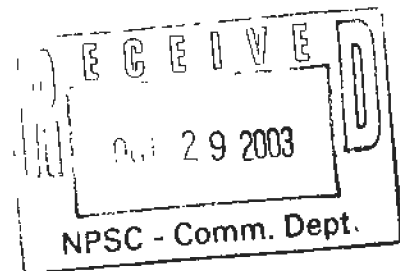

(D)

ISSUED:
October 29, 2003

BY: Warren D. Hannah
Director, Tariffs

EFFECTIVE:
November 10, 2003

GENERAL EXCHANGE TARIFF

UNITED TELEPHONE COMPANY
OF THE WEST
NEBRASKA

Section 27
First Revised Sheet 18
Cancels Original Sheet 18

PRIVATE LINE SERVICES AND CHANNELS

(D)

(D)

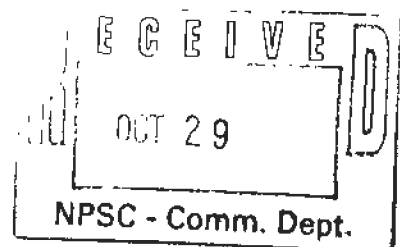

ISSUED:
October 29, 2003

BY: Warren D. Hannah
Director, Tariffs

EFFECTIVE:
November 10, 2003

GENERAL EXCHANGE TARIFF

UNITED TELEPHONE COMPANY
OF THE WEST
NEBRASKA

Section 27
First Revised Sheet 19
Cancels Original Sheet 19

PRIVATE LINE SERVICES AND CHANNELS

(D)

(D)

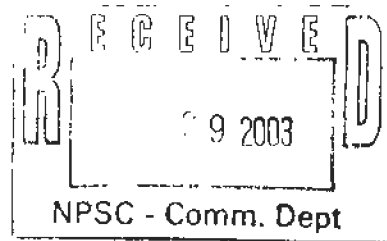

(D)

ISSUED:
October 29, 2003

BY: Warren D. Hannah
Director, Tariffs

EFFECTIVE:
November 10, 2003

GENERAL EXCHANGE TARIFF

UNITED TELEPHONE COMPANY
OF THE WEST
NEBRASKA

Section 27
Second Revised Sheet 20
Cancels First Revised Sheet 20

PRIVATE LINE SERVICES AND CHANNELS

(D)

(D)

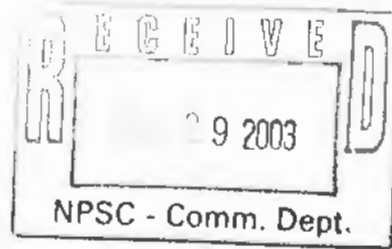

(D)

ISSUED:
October 29, 2003

BY: Warren D. Hannah
Director, Tariffs

EFFECTIVE:
November 10, 2003

GENERAL EXCHANGE TARIFF

UNITED TELEPHONE COMPANY
OF THE WEST
NEBRASKA

Section 27
Second Revised Sheet 21
Cancels First Revised Sheet 21

PRIVATE LINE SERVICES AND CHANNELS

(D)

(D)

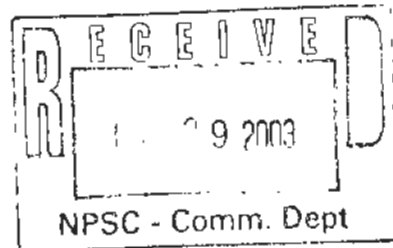

(D)

ISSUED:
October 29, 2003

BY: Warren D. Hannah
Director, Tariffs

EFFECTIVE:
November 10, 2003

GENERAL EXCHANGE TARIFF

UNITED TELEPHONE COMPANY
OF THE WEST
NEBRASKA

Section 27
First Revised Sheet 22
Cancels Original Sheet 22

PRIVATE LINE SERVICES AND CHANNELS

(D)

(D)

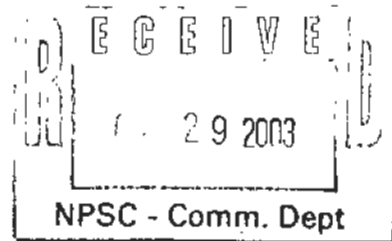

ISSUED:
October 29, 2003

BY: Warren D. Hannah
Director, Tariffs

EFFECTIVE:
November 10, 2003

GENERAL EXCHANGE TARIFF

UNITED TELEPHONE COMPANY
OF THE WEST
NEBRASKA

Section 28
Fourth Revised Sheet 1
Cancels Third Revised Sheet 1

LINK SERVICES

CONTENTS

	SHEET
A. LINK SERVICES	1
1. General	2
2. Regulations	3
3. Term Discount Plan (TDP).....	14
4. Termination Liability Charges	15
5. Rate Categories.....	16
6. Application of Rates	24
7. Rates and Charges	28

(N)

(N)

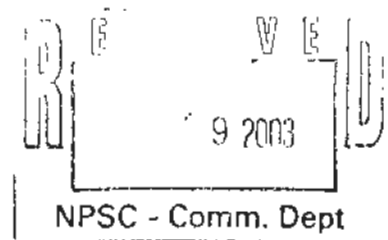

ISSUED:
October 29, 2003

BY: Warren D. Hannah
Director, Tariffs

EFFECTIVE:
November 10, 2003

GENERAL EXCHANGE TARIFF

UNITED TELEPHONE COMPANY OF THE WEST
d/b/a CENTURYLINK
NEBRASKA

Section 28
Third Revised Sheet 2
Cancels Second Revised Sheet 2

LINK SERVICES

A. LINK SERVICES

Effective September 1, 2020, Digilink Service (all speeds) and Translink Service (speeds of 128 Kbps, 256 Kbps, 384 Kbps, 512 Kbps) are grandfathered. Availability to current customers is limited to lines in service at existing locations.

(N)
:
(N)

1. GENERAL

- a. Digilink, Translink, and Lightlink Services are furnished for Private Line IntraLATA Intraexchange and Interexchange communications by the Telephone Company.
- b. Digilink, Translink, and Lightlink Services are for the transmission of digital signals and uses digital transmission facilities.
- c. Digilink Service provides for the simultaneous two-way transmission of synchronous digital signals at speeds of 19.2 Kbps, 56.0 Kbps, and 64.0 Kbps, where facilities exist.

Translink Service provides for the simultaneous two-way transmission of isochronous digital signals at speeds of 128 Kbps, 256 Kbps, 384 Kbps, 512 Kbps, and 1.544 Mbps (DS1), where facilities exist.

Lightlink Service provides for the simultaneous two-way transmission of isochronous digital signals at a speed of 44.736 Mbps (DS3), where facilities exist.
- d. To ensure satisfactory operation, the terminal equipment provided by the customer must be compatible with the Digilink, Translink, and Lightlink Service channel facility provided by the Telephone Company.
- e. Unless specified following, the regulations for Digilink, Translink, and Lightlink Services specified herein apply in addition to the regulations set forth in other sections of this tariff.
- f. The rates specified for Digilink, Translink, and Lightlink Services in A.7. following contemplate the provision of a digital quality facility utilizing existing interoffice carrier equipment and/or exchange cable facilities compatible with this service. If equipment, new facilities or changes to existing facilities are required for the provision of this service, then charges as specified in Section 3, Construction Charges and Other Special Charges, will apply in addition to the rates for Digilink, Translink, and Lightlink Services.
- g. Suspension of Service at Request of Subscribers as defined in Section 20 of this tariff, is not allowed.
- h. The minimum period for which Digilink and Translink Services are furnished and for which charges are applicable is six (6) months. The minimum period for Lightlink Service is twelve (12) months.

ISSUED:
August 20, 2020

BY: Darlene Terry
Manager, Tariffs

EFFECTIVE:
September 1, 2020

NE2020-12

Received by NPSC
08/20/2020

GENERAL EXCHANGE TARIFF

UNITED TELEPHONE COMPANY
OF THE WEST
NEBRASKA

Section 28
First Revised Sheet 3
Cancels Original Sheet 3

LINK SERVICES

A. LINK SERVICES (Cont'd)

2. REGULATIONS

a. Description of Service

- (1) Digilink Service is furnished for the simultaneous two-way transmission of digital signals at synchronous rates of 19.2 Kbps, 56.0 Kbps, and 64.0 Kbps between two or more points located within a LATA. Digilink is furnished for duplex operation only. The required format and interface specifications are contained in Technical Reference Publications TR-NWT-000341 and MDP-326-726. (T)
- (2) Translink Service provides a high capacity channel for the transmission of 1.544 Mbps isochronous serial data having a line code of Bipolar Return-to-Zero (BPRZ). Translink Service is provided between two points located within a LATA. The required format and interface specifications are contained in Technical Reference Publications GR-54 and GR-342. (T)
- (3) Fractional DS1 channels are also available and provide simultaneous, two-way transmission at contiguous bit rates of 128, 256, 384 and 512 Kbps. Fractional DS1 Channels operate over the combined bandwidth of adjacent channels to create a contiguous bit rate. Due to technical limitations associated with the provision of Fractional DS1 Channels, this service will be offered only in end offices where a compatible channel bank exists and the distance between the central office and the customer designated premises is less than or equal to twelve thousand (12,000) feet.



GENERAL EXCHANGE TARIFF

UNITED TELEPHONE COMPANY
OF THE WEST
NEBRASKA

Section 28
First Revised Sheet 4
Cancels Original Sheet 4

LINK SERVICES

A. LINK SERVICES (Cont'd)

2. REGULATIONS (Cont'd)

a. Description of Service (Cont'd)

- (4) Lightlink Service provides a high capacity channel for the transmission of 44.736 Mbps isochronous serial data having a line code of bipolar three zero substitution (B3ZS). Lightlink Service is provided between two points located within a LATA. Lightlink Service is available utilizing an electrical interface. The interface will have the characteristics of its respective signal at the point of demarcation. The required format and interface specifications are contained in Technical Reference Publication 62508 and 62411, and the associated Addendum TR-INS-000342 and TR-NPL-000054. (T)
- (5) A Channel Service Unit (CSU) or appropriate termination equipment provided by the customer is required at a customer's or authorized user's premises to perform such functions as:
- proper termination of the service
 - amplification
 - signal shaping
 - remote loop-back
- (6) The design, maintenance and operation of Digilink, Translink, and Lightlink Services contemplate communications originating and terminating as, (1) a customer premises to customer premises channel via the Telephone Company's Serving Wire Center and/or through remote Serving Wire Centers; (2) a customer premises to the Serving Wire Center and/or remote Serving Wire Centers - partial channel (link); or (3) a central office to central office (interoffice) partial channel (link). (T)



ISSUED:
September 20, 2004

BY: Warren D. Hannah
Director, Tariffs

EFFECTIVE:
September 30, 2004

GENERAL EXCHANGE TARIFF

UNITED TELEPHONE COMPANY
OF THE WEST
NEBRASKA

Section 28
First Revised Sheet 5
Cancels Original Sheet 5

LINK SERVICES

A. LINK SERVICES (Cont'd)

2. REGULATIONS (Cont'd)

a. Description of Service (Cont'd)

(7) Service Configurations

There are two types of service configurations over which Link Services are provided: two-point service and multipoint service. Multipoint service is available with Digilink Service and involves applications requiring three or more locations. Multipoint service is not available with Translink Service or Lightlink Service. (T) (T)

(a) Two-Point Service

A two-point service connects two customer designated premises, either on a directly connected basis or through a hub where multiplexing functions are performed or a customer designated premises.

Applicable rate elements are:

- Channel Terminations
- Channel Mileage (as applicable)
- Optional Features and Functions (when applicable)

The following diagram depicts a two-point service connecting two customer designated premises located 15 miles apart.

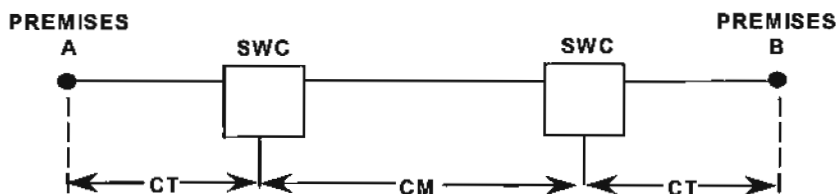

CT Channel Termination
 CM Channel Mileage
 SWC Serving Wire Center

Applicable rate elements are:

- Channel Terminations (2 applicable)
- Channel Mileage (1 Termination and 15 Facility)

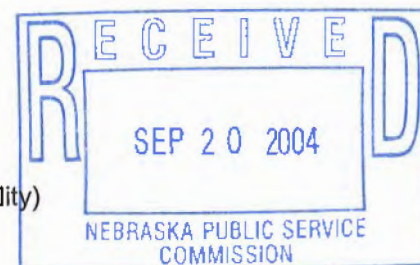

GENERAL EXCHANGE TARIFF

UNITED TELEPHONE COMPANY
OF THE WEST
NEBRASKA

Section 28
Original Sheet 6

LINK SERVICES

A. LINK SERVICES (Cont'd)

2. REGULATIONS (Cont'd)

a. Description of Service (Cont'd)

(7) Service Configurations (Cont'd)

(b) Multipoint Service

Multipoint service connects three or more customer designated premises through a Telephone Company hub. There is no limitation on the number of mid-links available with multipoint service. However, when more than three mid-links are provided in tandem, the quality of the service may be degraded. A mid-link is a channel between hubs (i.e., bridging locations).

Applicable rate elements are:

- Channel Terminations (one per customer designated premises)
- Channel Mileage (as applicable between each designated customer premises and the hub, and between hubs)
- Additional Optional Features and Functions (when applicable)

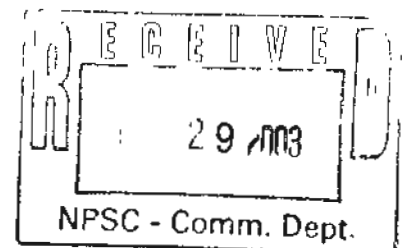

ISSUED:
October 29, 2003

BY: Warren D. Hannah
Director, Tariffs

EFFECTIVE:
November 10, 2003

GENERAL EXCHANGE TARIFF

UNITED TELEPHONE COMPANY
OF THE WEST
NEBRASKA

Section 28
Original Sheet 7

LINK SERVICES

A. LINK SERVICES (Cont'd)

2. REGULATIONS (Cont'd)

a. Description of Service (Cont'd)

(7) Service Configurations (Cont'd)

(b) Multipoint Service (Cont'd)

The following diagram depicts a service connecting four customer premises via two customer specified bridging hubs.

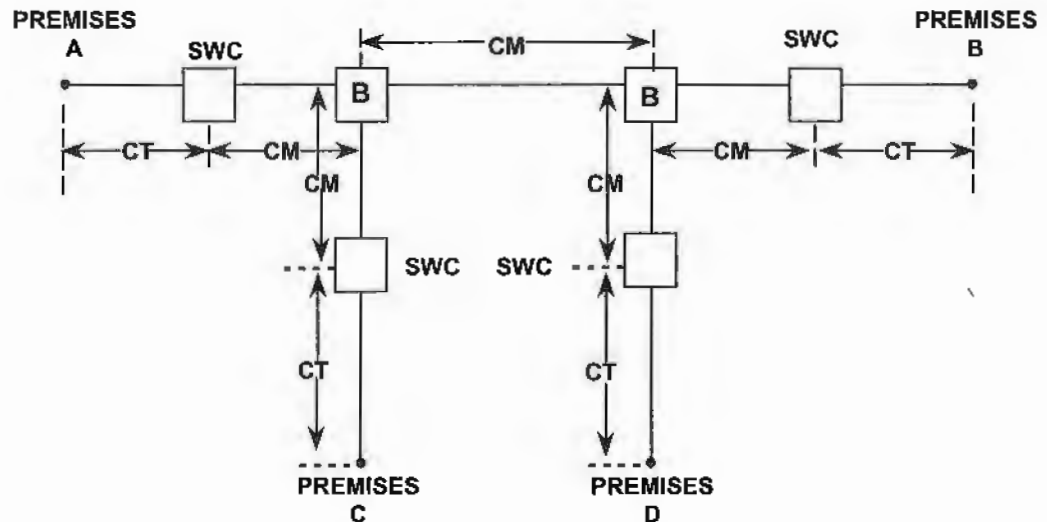

- CT - Channel Termination
- CM - Channel Mileage
- B - Bridging
- SWC - Serving Wire Center

Applicable rate elements are:

- Channel Terminations (4 applicable)
- Channel Mileage (5 sections, Termination and Facility as appropriate)
- Bridging (6 applicable, i.e., each bridge port)

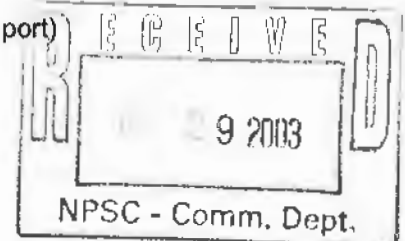

ISSUED:
October 29, 2003

BY: Warren D. Hannah
Director, Tariffs

EFFECTIVE:
November 10, 2003

GENERAL EXCHANGE TARIFF

UNITED TELEPHONE COMPANY
OF THE WEST
NEBRASKA

Section 28
Original Sheet 8

LINK SERVICES

A. LINK SERVICES (Cont'd)

2. REGULATIONS (Cont'd)

b. Definitions

- (1) Central Office Bridging Capability - Provides for the parallel connection of one virtual circuit to another virtual circuit without interrupting the integrity or continuity of the first. This service is only available from a Telephone Company-designated digital hub.
- (2) Channel Mileage - Provides for the end office equipment and the transmission channel between the Serving Wire Centers associated with two customer designated premises, between a Serving Wire Center associated with a customer designated premises and a Telephone Company hub, or between two Telephone Company hubs. Channel Mileage is comprised of Channel Mileage Facility (per mile) and Channel Mileage Termination (fixed) rates.
 - (a) Channel Mileage Facility (Per Mile) - The Channel Mileage Facility (per mile) recovers the cost for the transmission path that extends between the Telephone Company Serving Wire Centers and/or hub(s) and includes primarily outside plant used to provide the facility.
 - (b) Channel Mileage Termination (Fixed) - Channel Mileage Termination (fixed) recovers the cost for end office equipment associated with terminating the facility (i.e., basic circuit equipment and terminations at Serving Wire Centers).
- (3) Channel Service Unit (CSU) - Denotes equipment provided by the customer which performs one or more of the following functions: termination of a digital facility, regeneration of digital signals, detection and/or correction of signal format errors and remote loop back.
- (4) Channel Termination - The local facility from the customer's designated premises to the Serving Wire Center.
- (5) Data Amplification - Provides for data transmission when the customer is located beyond the normal range for high speed digital data service. Channel Terminations greater than five (5) cable route miles in length for 19.2 Kbps service or three (3) miles in length for 56 Kbps and 64 Kbps service may require circuit repeaters and associated equipment be installed to regenerate the digital signal in order for accurate and acceptable data transmission to occur. The distances given are an indication of the potential requirement for Data Amplification. The actual distance is dependent on decibel (db) loss and not just physical loop length and is a function of the specific Telephone Company cable between the Serving Wire Center and the customer's location.

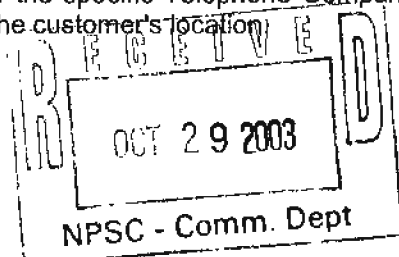

ISSUED:
October 29, 2003

BY: Warren D. Hannah
Director, Tariffs

EFFECTIVE:
November 10, 2003

GENERAL EXCHANGE TARIFF

UNITED TELEPHONE COMPANY
OF THE WEST
NEBRASKA

Section 28
First Revised Sheet 9
Cancels Original Sheet 9

LINK SERVICES

A. LINK SERVICES (Cont'd)

2. REGULATIONS (Cont'd)

b. Definitions (Cont'd)

- (6) Clear Channel Capability (CCC) - Denotes the transport of twenty-four, 64 Kbps channels over a 1.544 Mbps Translink Service via B8ZS line code format. (T)
- (7) Customer Designated Premises - Denotes the premises specified by the customer for the provision of Link Services.
- (8) DS3 - Denotes a channel service expressed in terms of its digitally encoded data bit rate in accordance with the North American hierarchy of digital signal levels. It has a 44.736 Mbps transmission data rate, and provides for the two-way simultaneous transmission of randomized Non-Return-to-Zero (NRZ) signals with B3ZS format.
- (9) Hub - A Telephone Company designated Serving Wire Center at which bridging or multiplexing functions are performed. The bridging functions performed may be used to connect three or more customer designated premises in a multipoint arrangement. The multiplexing functions are to channelize digital facilities to individual services requiring a lower capacity or bandwidth.
- (10) Multipoint Service - Connects three or more customer designated premises through a Telephone Company hub. There is no limitation on the number of mid-links available with multipoint service. However, when more than three mid-links are provided in tandem, the quality of the service may be degraded. A mid-link is a channel between hubs (i.e., bridging locations).
- (11) Nonrecurring Charge - A one-time charge for the initial installation, the installation of functions and features and service rearrangements.
- (12) Serving Wire Center - Denotes the wire center from which the customer designated premises would normally obtain dial tone from the Telephone Company.
- (13) Two-Point Service - Connects two customer designated premises, either on a directly connected basis or through a hub where multiplexing functions are performed or a customer designated premises.

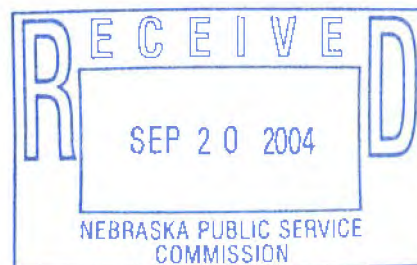

ISSUED:
September 20, 2004

BY: Warren D. Hannah
Director, Tariffs

EFFECTIVE:
September 30, 2004

GENERAL EXCHANGE TARIFF

UNITED TELEPHONE COMPANY
OF THE WEST
NEBRASKA

Section 28
First Revised Sheet 10
Cancels Original Sheet 10

LINK SERVICES

A. LINK SERVICES (Cont'd)

2. REGULATIONS (Cont'd)

c. Connections

- (1) Customer-Provided Terminal Equipment, Customer-Provided Derivation Equipment and Customer-Provided Communications Systems may be connected to Digilink, Translink and Lightlink Services when such connection is made in accordance with the provisions specified in (2), (3) and (4) following. (T)
- (2) Responsibility of the Telephone Company
 - (a) The responsibility of the Telephone Company shall be limited to the furnishing and maintenance of Digilink, Translink and Lightlink Services to a network interface on the customer's premises where provision is made for the connection of local service.
 - (b) The Telephone Company shall not be responsible for installation, operation or maintenance of any terminal equipment or communications systems provided by the customer. Digilink, Translink and Lightlink Services are not represented as adapted for the use of such equipment or system. Where such equipment or system is connected to Telephone Company facilities, the responsibility of the Telephone Company shall be limited to the furnishing of facilities suitable for Digilink, Translink and Lightlink Services and to the maintenance and operation in a manner proper for such digital service. The Telephone Company shall not be responsible for:
 - The through transmission of signals generated by such equipment or system, or for the quality of, or defects in, such transmission, or
 - The reception of signals by such equipment or systems, or
 - Damage to terminal equipment or communications systems provided by a customer or authorized user due to testing.
 - (c) The Telephone Company shall not be responsible to the customer if changes in any of the facilities, operations or procedures of the Telephone Company utilized in the provision of Digilink, Translink and Lightlink Services render any facilities or equipment provided by a customer obsolete, or require modification or alteration of such equipment or system or otherwise affects its use or performance.



ISSUED:
September 20, 2004

BY: Warren D. Hannah
Director, Tariffs

EFFECTIVE:
September 30, 2004

GENERAL EXCHANGE TARIFF

UNITED TELEPHONE COMPANY
OF THE WEST
NEBRASKA

Section 28
First Revised Sheet 11
Cancels Original Sheet 11

LINK SERVICES

A. LINK SERVICES (Cont'd)

2. REGULATIONS (Cont'd)

c. Connections (Cont'd)

(2) Responsibility of the Telephone Company (Cont'd)

- (d) The Telephone Company is responsible for maintaining and repairing the facilities it furnishes. The customer may not rearrange, disconnect, remove or attempt to repair any equipment installed by the Telephone Company without prior written consent of the Telephone Company.
- (e) Digilink, Translink and Lightlink Services are designed to meet or exceed a performance objective of 99% error-free seconds of transmission per 1000 seconds on a daily basis and 99.9% availability on an annual basis when measured through the digital termination equipment. (T)
- (f) In order to maintain the quality of Digilink, Translink and Lightlink Services, the Telephone Company reserves the right to perform preventative maintenance and software updates to the network. The Telephone Company has classified maintenance as follows:

(i) Scheduled Maintenance

Scheduled maintenance is performed for functions such as hardware and software upgrades and network optimization. The Telephone Company will perform these tasks in a maintenance window that is anticipated to minimize disruption of customer service and activity. The Telephone Company will provide advance notice of all scheduled maintenance.

(ii) Demand Maintenance

Demand maintenance may occur as a result of unexpected events and is performed when Digilink, Translink and Lightlink Services network elements are in jeopardy. The Telephone Company will perform this type of maintenance at its discretion. Due to the nature of demand maintenance, prior notification may not be possible; however, the customer will be informed when the maintenance has been completed.



GENERAL EXCHANGE TARIFF

UNITED TELEPHONE COMPANY
OF THE WEST
NEBRASKA

Section 28
First Revised Sheet 12
Cancels Original Sheet 12

LINK SERVICES

A. LINK SERVICES (Cont'd)

2. REGULATIONS (Cont'd)

c. Connections (Cont'd)

(3) Responsibility of the Customer

(a) The customer is responsible for installing and testing the customer premises equipment or facilities to insure that when they are connected to Digilink, Translink and Lightlink Services such equipment or facilities are operating properly. (T)

(b) The operating characteristics of the customer premises equipment or facilities shall be such as to not interfere with any of the services offered by the Telephone Company. Such use is subject to the further provisions that the equipment provided by a customer does not: endanger the safety of Telephone Company employees or the public; damage, require change in or alteration of the equipment or other facilities of the Telephone Company; interfere with the proper functioning of such equipment or facilities; impair the operation of the Telephone Company's facilities or otherwise injure the public in its use of the Telephone Company's services. Upon notice that the equipment provided by a customer is causing or is likely to cause such hazard or interference, the customer shall take such steps as shall be necessary to remove or prevent such hazard or interference.

(c) The customer's responsibility shall include cooperative testing with the Telephone Company as may be necessary. Where regeneration and/or equalization adjustments or changes may be required to compensate for rearrangements and/or changes in outside plant facilities, the customer will be responsible for all expenses incurred in changes to his customer premises equipment.

(4) Connection of Customer-Provided Terminal Equipment, Customer-Provided Derivation Equipment and Customer-Provided Communications Systems

(a) The following provisions will apply:

(i) Customer-Provided Terminal Equipment and/or Customer-Provided Communications Systems may be connected at the premises of the customer to Digilink, Translink and Lightlink Services.

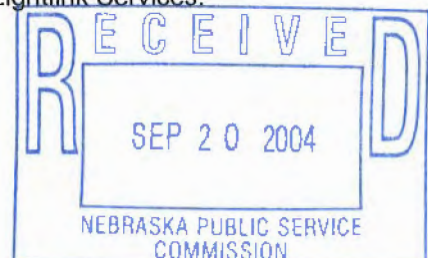

GENERAL EXCHANGE TARIFF

UNITED TELEPHONE COMPANY
OF THE WEST
NEBRASKA

Section 28
First Revised Sheet 13
Cancels Original Sheet 13

LINK SERVICES



A. LINK SERVICES (Cont'd)

2. REGULATIONS (Cont'd)

c. Connections (Cont'd)

(4) Connection of Customer-Provided... (Cont'd)

(a) The following provisions will apply: (Cont'd)

(ii) The customers, by use of their own derivation equipment, may create digital bit streams from Digilink, Translink and Lightlink Services and such equipment may be connected for transmission of such bit streams when connected through a customer-provided CSU. (T)

(iii) The undertaking of the Telephone Company is to furnish Digilink, Translink and Lightlink Services as ordered and specified by the customer except as specified in (d) following.

(b) Connections to Other Services Furnished by the Company to the Same Customer

Digilink, Translink and Lightlink Services furnished by the Telephone Company may be connected by the customer to another service or to other services furnished by the Telephone Company as specified in (2) preceding. Connected services are subject to all rules and regulations governing the provisioning of those services.

(c) Connections to Other Services Furnished by the Telephone Company to Different Customers

The customer may connect at the premises of the customer, to another Digilink, Translink and Lightlink Service or other services furnished by the Telephone Company to different customers as specified in (2) preceding. Connected services are subject to all rules and regulations governing provisioning of those services.

(d) Connection of Channel Service Units

A Channel Service Unit (CSU) or appropriate termination equipment must be provided by the customer to connect a Telephone Company-provided digital facility. This equipment must comply with the technical requirements outlined in Part 68 of the FCC Rules and Regulations.

GENERAL EXCHANGE TARIFF

UNITED TELEPHONE COMPANY
OF THE WEST
NEBRASKA

Section 28
First Revised Sheet 14
Cancels Original Sheet 14

LINK SERVICES



A. LINK SERVICES (Cont'd)

2. REGULATIONS (Cont'd)

c. Connections (Cont'd)

(4) Connection of Customer-Provided... (Cont'd)

- (e) The customer shall be responsible for payment of a Maintenance of Service Charge, as set forth in Section 11 of the General Exchange Price List, for visits by the Telephone Company to the customer's premises where the service difficulty or trouble report results from the use of equipment or facilities provided by the customer.
- (f) The customer may not rearrange, disconnect, remove or attempt to repair any equipment installed by the Telephone Company without the prior written consent of the Telephone Company.
- (g) For maintenance purposes, upon request of the Telephone Company, the customer will be responsible for notifying the Telephone Company of the type of digital terminating equipment used.

3. TERM DISCOUNT PLAN (TDP)

- a. A Term Discount Plan (TDP) provides the customer with discounted rates for Digilink, Translink and Lightlink Services. Digilink, Translink and Lightlink Service may be ordered under a TDP for fixed periods of 12 - 23 months, 24 - 35 months, 36 - 59 months, and 60 - 84 months. For Lightlink Service, month-to-month rates may apply only after the expiration of a TDP. All rate elements within the same Digilink, Translink and Lightlink Service facilities must be ordered under the same commitment period and under the same service date. The customer must order the TDP in writing to the Company. A TDP may be ordered in one-month increments, (e.g. a 28-month commitment period or a 37-month commitment period). (T)
- b. The customer must specify the length of the initial service period at the time the service is ordered. When a customer converts to a TDP, Nonrecurring Charges do not apply toward facilities in-service at that time. If a customer converts from month-to-month rates to a TDP or upgrades from one TDP to another, Nonrecurring Charges and Service Connection Charges do not apply.
- c. At the end of the TDP the customer may subscribe to a new TDP at the prevailing rates set forth in A.7. following. If the customer does not select a new TDP, the rates will convert to the prevailing month-to-month rates.
- d. Rate increases or decreases will automatically be applied to the monthly term plan rates for the remaining term of the TDP. If Telephone Company initiated rate increases to any rate element or combination of rate elements causes the charges for the entire Digilink, Translink or Lightlink Service under the TDP to increase by 10% or more annually, then the customer may cancel the TDP without incurring termination liability charges provided the customer notifies the Telephone Company within 30 days after the effective date of the rate increase. (T)

ISSUED:
September 20, 2004

BY: Warren D. Hannah
Director, Tariffs

EFFECTIVE:
September 30, 2004

GENERAL EXCHANGE TARIFF

UNITED TELEPHONE COMPANY
OF THE WEST
NEBRASKA

Section 28
First Revised Sheet 15
Cancels Original Sheet 15

LINK SERVICES

A. LINK SERVICES (Cont'd)

3. TERM DISCOUNT PLAN (TDP) (Cont'd)

- e. The customer can extend TDP commitment periods at any time during the term of the plan, up to a maximum of 84 months. The number of remaining months in the original term plan will become part of the total term in the new term plan.

4. TERMINATION LIABILITY CHARGES

- a. If a customer under a Term Discount Plan (TDP) disconnects all or a portion of Digilink, Translink or Lightlink Service prior to the expiration of the TDP, then a Termination Liability Charge will apply to those services that are disconnected. The Termination Liability Charge will be a one-time charge equal to sum of 50% of the payments remaining for the rest of the TDP. (T)
- b. Customers may move Channel Terminations and not be subject to Termination Liability Charges providing the terms of the TDP are maintained. If charges as specified in A.1.f. were applied to the service being terminated or moved, any termination or move charges associated with that construction apply, as well as any construction charges at the new location.
- c. Termination Liability Charges will not apply when a service or rate element under a TDP is disconnected prior to the expiration of a selected service period as a result of a change in tariff jurisdiction and/or a customer requested upgrade to a next generation service offering, under the following conditions:
 - (1) The service period of the new TDP for the new service offering is a period equal to or exceeding the remaining service period of the disconnected TDP, and
 - (2) The service orders to install the new service and disconnect the old service are related together, and there is no lapse in service between the installation of the new service and the disconnection of the old service, and
 - (3) The service orders to install the new service and disconnect the old service are for the same customer at the same location.
- d. The Telephone Company will determine whether the replacement service qualifies as a next generation service offering.
- e. Nonrecurring charges and Service Connection Charges for the new service will apply according to the requirements of the new service. (T)



GENERAL EXCHANGE TARIFF

UNITED TELEPHONE COMPANY OF THE WEST
d/b/a CENTURLINK
NEBRASKA

Section 28
Second Revised Sheet 16
Cancels First Revised Sheet 16

LINK SERVICES

A. LINK SERVICES (Cont'd)

5. RATE CATEGORIES

a. Digilink Service

Effective September 1, 2020, Digilink Service is grandfathered. Availability to current customers is limited to lines in service at existing locations.

(N)
(N)

There are two rate categories which apply to Digilink Service:

- Channel Termination
- Channel Mileage

(1) Channel Termination

The Channel Termination rate category provides for the communications path between a customer designated premises and the Serving Wire Center. Included as part of the Channel Termination is a standard channel interface arrangement which defines the technical characteristics associated with the type of facilities to which the service is to be connected at the point of termination (POT) and the type of signaling capability if any. The signaling capability itself is provided as a part of this rate category. One Channel Termination charge applies per customer designated premises at which the channel is terminated. Channel Termination charges are set forth in A.7.a.

(2) Channel Mileage

The Channel Mileage rate category provides for the end office equipment and the transmission channel between the Serving Wire Centers associated with two customer designated premises, between a Serving Wire Center associated with a customer designated premises and a Telephone Company hub, or between two Company hubs. Channel Mileage rates are made up of the Channel Mileage Facility (per mile) rate and the Channel Mileage Termination (fixed) rate. Channel Mileage charges are set forth in A.7.b.

ISSUED:
August 20, 2020

BY: Darlene Terry
Manager, Tariffs

EFFECTIVE:
September 1, 2020

NE 2020-12

Received by NPSC
08/20/2020

GENERAL EXCHANGE TARIFF

UNITED TELEPHONE COMPANY
OF THE WEST
NEBRASKA

Section 28
First Revised Sheet 17
Cancels Original Sheet 17

LINK SERVICES

A. LINK SERVICES (Cont'd)

5. RATE CATEGORIES (Cont'd)

a. Digilink Service (Cont'd)

(T)

(2) Channel Mileage (Cont'd)

(a) Channel Mileage Facility (Per Mile)

The Channel Mileage Facility (per mile) rate recovers the cost for the transmission path, which extends between the Telephone Company Serving Wire Centers and/or hub(s) and includes primarily outside plant used to provide the facility.

(b) Channel Mileage Termination (Fixed)

The Channel Mileage Termination (fixed) rate recovers the cost for end office equipment associated with terminating the facility (i.e., basic circuit equipment and terminations at Serving Wire Centers). The Telephone Company applies a 50% billing percentage to the channel mileage fixed rate on jointly owned circuits, and applies 100% on wholly owned circuits. When the Channel Mileage Facility (per mile) is zero (i.e., collocated Serving Wire Centers), neither the Channel Mileage Facility (per mile) rate nor the Channel Mileage Termination (fixed) rate will apply.



GENERAL EXCHANGE TARIFF

UNITED TELEPHONE COMPANY OF THE WEST
d/b/a CENTURYLINK
NEBRASKA

Section 28
Second Revised Sheet 18
Cancels First Revised Sheet 18

LINK SERVICES

A. LINK SERVICES (Cont'd)

5. RATE CATEGORIES (Cont'd)

b. Translink Service

Effective September 1, 2020, Translink Service at speeds of 128 Kbps, 256 Kbps, 384 Kbps, 512 Kbps is grandfathered. Availability to current customers is limited to lines in service at existing locations.

(N)
:
(N)

There are two rate categories which apply to Translink Service:

- Channel Termination
- Channel Mileage

(1) Channel Termination

The Channel Termination rate category provides for the communications path between a customer designated premises and the Serving Wire Center. Included as part of the Channel Termination is a standard channel interface arrangement which defines the technical characteristics associated with the type of facilities to which the service is to be connected at the point of termination (POT) and the type of signaling capability if any. The signaling capability itself is provided as a part of this rate category. One Channel Termination charge applies per customer designated premises at which the channel is terminated. Channel Termination charges are set forth in A.7.a.

(2) Channel Mileage

The Channel Mileage rate category provides for the end office equipment and the transmission channel between the Serving Wire Centers associated with two customer designated premises, between a Serving Wire Center associated with a customer designated premises and a Company hub, or between two Telephone Company hubs. Channel Mileage rates are made up of the Channel Mileage Facility (per mile) rate and the Channel Mileage Termination (fixed) rate. Channel Mileage charges are set forth in A.7.b.

ISSUED:
August 20, 2020

BY: Darlene Terry
Manager, Tariffs

EFFECTIVE:
September 1, 2020

NE.2020-12

Received by NPSC
08/20/2020

GENERAL EXCHANGE TARIFF

UNITED TELEPHONE COMPANY
OF THE WEST
NEBRASKA

Section 28
First Revised Sheet 19
Cancels Original Sheet 19

LINK SERVICES

A. LINK SERVICES (Cont'd)

5. RATE CATEGORIES (Cont'd)

b. Translink Service (Cont'd)

(T)

(2) Channel Mileage (Cont'd)

(a) Channel Mileage Facility (Per Mile)

The Channel Mileage Facility (per mile) rate recovers the cost for the transmission path, which extends between the Telephone Company Serving Wire Centers and/or hub(s) includes primarily outside plant used to provide the facility.

(b) Channel Mileage Termination (Fixed)

The Channel Mileage Termination (fixed) rate recovers the cost for end office equipment associated with terminating the facility (i.e., basic circuit equipment and terminations at Serving Wire Centers). The Telephone Company applies a 50% billing percentage to the channel mileage fixed rate on jointly owned circuits, and applies 100% on wholly owned circuits. When the Channel Mileage Facility (per mile) is zero (i.e., collocated Serving Wire Centers), neither the Channel Mileage Facility (per mile) rate nor the Channel Mileage Termination (fixed) rate will apply.



ISSUED:
September 20, 2004

BY: Warren D. Hannah
Director, Tariffs

EFFECTIVE:
September 30, 2004

GENERAL EXCHANGE TARIFF

UNITED TELEPHONE COMPANY
OF THE WEST
NEBRASKA

Section 28
First Revised Sheet 20
Cancels Original Sheet 20

LINK SERVICES

A. LINK SERVICES (Cont'd)

5. RATE CATEGORIES (Cont'd)

c. Lightlink Service (T)

There are two rate categories which apply to Lightlink Service: (T)

- Channel Termination
- Channel Mileage

(1) Channel Termination

The Channel Termination rate category provides for the communications path between a customer designated premises and the Serving Wire Center. Included as part of the Channel Termination is a standard channel interface arrangement which defines the technical characteristics associated with the type of facilities to which the service is to be connected at the point of termination (POT) and the type of signaling capability if any. The signaling capability itself is provided as a part of this rate category. One Channel Termination charge applies per customer designated premises at which the channel is terminated. The charges applicable to the Channel Termination vary based on distance, as set forth in A.7.a. following.

(2) Channel Mileage

The Channel Mileage rate category provides for the end office equipment and the transmission channel between the Serving Wire Centers associated with two customer designated premises, between a Serving Wire Center associated with a customer designated premises and a Telephone Company hub, or between two Company hubs. Channel Mileage rates are made up of the Channel Mileage Facility (per mile) rate and the Channel Mileage Termination (fixed) rate. Channel Mileage charges are set forth in A.7.b.

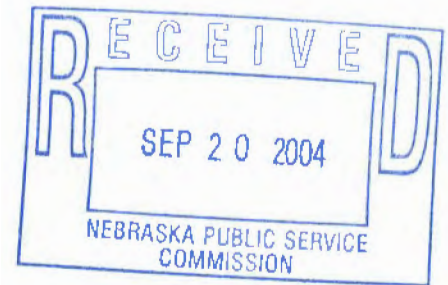

GENERAL EXCHANGE TARIFF

UNITED TELEPHONE COMPANY
OF THE WEST
NEBRASKA

Section 28
First Revised Sheet 21
Cancels Original Sheet 21

LINK SERVICES

A. LINK SERVICES (Cont'd)

5. RATE CATEGORIES (Cont'd)

c. Lightlink Service (Cont'd)

(T)

(2) Channel Mileage (Cont'd)

(a) Channel Mileage Facility (Per Mile)

The Channel Mileage Facility (per mile) rate recovers the cost for the transmission path, which extends between the Telephone Company Serving Wire Centers and/or hub(s) includes primarily outside plant used to provide the facility.

(b) Channel Mileage Termination (Fixed)

The Channel Mileage Termination (fixed) rate recovers the cost for end office equipment associated with terminating the facility (i.e., basic circuit equipment and terminations at Serving Wire Centers). The Telephone Company applies a 50% billing percentage to the channel mileage fixed rate on jointly owned circuits, and applies 100% on wholly owned circuits. When the Channel Mileage Facility (per mile) is zero (i.e., collocated Serving Wire Centers), neither the Channel Mileage Facility (per mile) rate nor the Channel Mileage Termination (fixed) rate will apply.

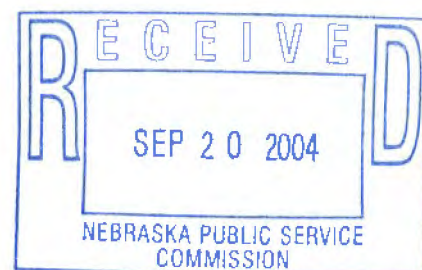

ISSUED:
September 20, 2004

BY: Warren D. Hannah
Director, Tariffs

EFFECTIVE:
September 30, 2004

GENERAL EXCHANGE TARIFF

UNITED TELEPHONE COMPANY
OF THE WEST
NEBRASKA

Section 28
First Revised Sheet 22
Cancels Original Sheet 22

LINK SERVICES

A. LINK SERVICES (Cont'd)

5. RATE CATEGORIES (Cont'd)

d. Optional Features and Functions - Applicable to Translink and Lightlink Service (T)

Optional Features and Functions may be added to improve the quality or utility to meet the customer's specific communications requirements. These are not necessarily identifiable with specific equipment, but rather represent the end result in terms of performance characteristics, which may be obtained. These characteristics may be obtained by using various combinations of equipment. Optional Features and Functions that are available include the following:

(1) Central Office Multiplexing

DS3 to DS1 - An arrangement that converts a 44.736 Mbps channel to 28 DS1 channels using digital time division multiplexing. Central Office Multiplexing is not available at the customer's premises.

DS1 to DS0 - An arrangement that converts a 1.544 Mbps channel to twenty-four (24) 64.0 Kbps channels utilizing digital time division multiplexing. Central Office Multiplexing is not available at the customer's premises.

(2) Clear Channel Capability (CCC)

Clear Channel Capability (CCC) is an arrangement that alters a DS1/1.544 Mbps signal with unconstrained information bits to meet pulse density requirements outlined in Technical Reference Publications GR-54 and GR-342. This will allow a customer to transport an all zero octet over a DS1/1.544 Mbps channel providing an available combined maximum 1.536 Mbps data rate. This arrangement requires the customer signal at the channel interface to conform to Bipolar with 8 Zero Substitution (B8ZS) line code as described in Technical Reference Publications GR-54 and GR-342.

CCC is provided on DS1/1.544 Mbps channels of a Translink and Lightlink Service facility between two customer designated premises and is subject to the availability of facilities. This optional feature may be ordered at the same time the Translink and Lightlink Service channel is ordered, or it may be ordered as an additional feature of an existing Translink and Lightlink Service channel. (T)
(T)
(T)



GENERAL EXCHANGE TARIFF

UNITED TELEPHONE COMPANY
OF THE WEST
NEBRASKA

Section 28
First Revised Sheet 23
Cancels Original Sheet 23

LINK SERVICES

A. LINK SERVICES (Cont'd)

5. RATE CATEGORIES (Cont'd)

d. Optional Features and Functions - Applicable to Translink and Lightlink Service (Cont'd) (T)

(3) Extended Superframe Format (ESF)

The ESF optional feature is available at suitably equipped end offices, and passes a customer provided framing format for 1.544 Mbps service. ESF extends the customer's 1.544 Mbps framing structure from twelve (12) to twenty-four (24) frames and divides the 8 Kbps 193rd bit position pattern into three distinct functionalities: 2 Kbps for frame synchronization, 2 Kbps for cyclic redundancy checking, and 4 Kbps used primarily for performance monitoring information.

(4) Multiplexed Service Connection

For Translink Service, a Multiplexed Service Connection is an arrangement that allows one DS0 channel of a multiplexed Telephone Company service to be connected to one DS0 channel with like signaling of another Telephone Company service. A Multiplexed Service Connection will be provided at all Telephone Company locations where Central Office Multiplexing is performed. (T)

For Lightlink Service, a Multiplexed Service Connection is an arrangement that allows one DS1 channel of a multiplexed Telephone Company service to be connected to one DS1 channel with like signaling of another Telephone Company service. For example, the lesser speed may be an ISDN-PRI DS1 channel connected between a multiplexed DS3 service. A Multiplexed Service Connection will be provided at all Telephone Company locations where Central Office Multiplexing is performed. (T)

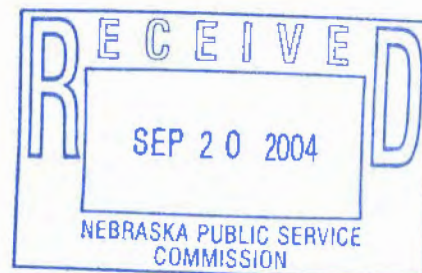

GENERAL EXCHANGE TARIFF

UNITED TELEPHONE COMPANY OF THE WEST
d/b/a CENTURYLINK
NEBRASKA

Section 28
Second Revised Sheet 24
Cancels First Revised Sheet 24

LINK SERVICES

A. LINK SERVICES (Cont'd)

6. APPLICATION OF RATES

a. Digilink Service - **GRANDFATHERED**

(C)

Effective September 1, 2020, Digilink Service is grandfathered. Availability to current customers is limited to lines in service at existing locations.

(N)

(N)

- (1) Each Digilink Service facility may be comprised of two or more Channel Terminations. Where both customer premises are served by the same Serving Wire Center, the service will consist of two or more Channel Terminations. Where each customer premises is served by different Serving Wire Centers, the service will consist of two or more Channel Terminations, one Channel Mileage Termination (fixed) and the Channel Mileage Facility (per mile) between Serving Wire Centers and/or hub(s).
- (2) Intraexchange channels furnished between Company central offices will be charged at rates based on airline distance between the central offices. Interexchange channels will be charged at rates based on airline distance between Company central offices. Fractional mileage will be rounded up to the next full mile. The mileage measurement is determined by utilizing exchange maps and mileage tables located in designated Telephone Company offices for such purposes.
- (3) Whenever facilities are provided jointly by the Telephone Company and another telephone company, the regulations, rates and charges of the other telephone company shall apply for the equipment and facilities furnished by the other telephone company for use in connection with Digilink Service. The Telephone Company applies a 50% billing percentage to the Channel Mileage Termination (fixed) rate on jointly owned circuits, and applies 100% on wholly owned circuits. When the Channel Mileage Facility (per mile) is zero (i.e., collocated Serving Wire Centers), neither the Channel Mileage Facility (per mile) rate nor the Channel Mileage Termination (fixed) rate will apply.

ISSUED:
August 20, 2020

BY: Darlene Terry
Manager, Tariffs

EFFECTIVE:
September 1, 2020

NE2020-12

Received by NPSC
08/20/2020

GENERAL EXCHANGE TARIFF

UNITED TELEPHONE COMPANY OF THE WEST
d/b/a CENTURYLINK
NEBRASKA

Section 28
Third Revised Sheet 25
Cancels Second Revised Sheet 25

LINK SERVICES

A. LINK SERVICES (Cont'd)

6. APPLICATION OF RATES (Cont'd)

a. Digilink Service - **GRANDFATHERED** (Cont'd)

(C)

- (4) Data Amplification provides for data transmission when the customer is located beyond the normal range for high speed digital data service. Local channel terminations greater than five (5) cable route miles in length for 19.2 Kbps service or three (3) miles in length for 56 Kbps and 64 Kbps service may require circuit repeaters and associated equipment be installed to regenerate the digital signal in order for accurate and acceptable data transmission to occur. The distances given are an indication of the potential requirement for Data Amplification. The actual distance is dependent on decibel (db) loss and not just physical loop length and is a function of the specific Telephone Company cable between the serving wire center and the customer's location. Applications requiring Data Amplification may also require special construction charges, Construction Charges and Other Special Charges, as specified in Section 3 of this tariff.
- (5) One Central Office Bridging Capability charge applies per port. When more than one Serving Wire Center is involved, the origin of the bridge(s) will dictate if there are additional interoffice transport charges (i.e., Channel Mileage Facility, Per Mileage). Refer to diagrams in A.2.a.(7) preceding.

ISSUED:
August 20, 2020

BY: Darlene Terry
Manager, Tariffs

EFFECTIVE:
September 1, 2020

NE2020-12

Received by NPSC
08/20/2020

GENERAL EXCHANGE TARIFF

UNITED TELEPHONE COMPANY OF THE WEST
d/b/a CENTURYLINK
NEBRASKA

Section 28
Second Revised Sheet 26
Cancels First Revised Sheet 26

LINK SERVICES

A. LINK SERVICES (Cont'd)

6. APPLICATION OF RATES (Cont'd)

b. Translink Service

Effective September 1, 2020, Translink Service at speeds of 128 Kbps, 256 Kbps, 384 Kbps, 512 Kbps is grandfathered. Availability to current customers is limited to lines in service at existing locations.

(N)
:
(N)

- (1) Each Translink Service facility is comprised of two Channel Terminations. Where both customer premises are served by the same Serving Wire Center, the service will consist of two Channel Terminations. Where each customer premises is served by different Serving Wire Centers, the service will consist of two Channel Terminations, one Channel Mileage Termination (fixed) and the Channel Mileage Facility (per mile) between Serving Wire Centers and/or hub(s).
- (2) Intraexchange channels furnished between Telephone Company central offices will be charged at rates based on airline distance between the central offices. Interexchange channels will be charged at rates based on airline distance between Telephone Company central offices. Fractional mileage will be rounded up to the next full mile. The mileage measurement is determined by utilizing exchange maps and mileage tables located in designated Telephone Company offices for such purposes.
- (3) Whenever facilities are provided jointly by the Telephone Company and another telephone company, the regulations, rates and charges of the other telephone company shall apply for the equipment and facilities furnished by the other telephone company for use in connection with Translink Service. The Telephone Company applies a 50% billing percentage to the Channel Mileage Termination (fixed) rate on jointly owned circuits, and applies 100% on wholly owned circuits. When the Channel Mileage Facility (per mile) is zero (i.e., collocated Serving Wire Centers), neither the Channel Mileage Facility (per mile) rate nor the Channel Mileage Termination (fixed) rate will apply.

ISSUED:
August 20, 2020

BY: Darlene Terry
Manager, Tariffs

EFFECTIVE:
September 1, 2020

NE2020-12

Received by NPSC
08/20/2020

GENERAL EXCHANGE TARIFF

UNITED TELEPHONE COMPANY
OF THE WEST
NEBRASKA

Section 28
First Revised Sheet 27
Cancels Original Sheet 27

LINK SERVICES

A. LINK SERVICES (Cont'd)

6. APPLICATION OF RATES (Cont'd)

c. Lightlink Service

(T)

(1) Each Lightlink Service facility may be comprised of one or two Channel Terminations. Where both customer premises are served by the same Serving Wire Center, the service will consist of two Channel Terminations. Where each customer premises is served by different Serving Wire Centers, the service will consist of two Channel Terminations, one Channel Mileage Termination (fixed) and the Channel Mileage Facility (per mile) between Serving Wire Centers and/or hub(s). Where one customer premises is involved, the Channel Termination of a lower bandwidth service can be replaced with a Lightlink Service Channel Termination. For example, the Channel Termination associated with ISDN-PRI Service, referred to as an ISDN-PRI Primary Rate Access Line, can be replaced with a Lightlink Service Channel Termination to connect the ISDN-PRI Service to the Serving Wire Center of the customer's designated premises.

(T)

(2) The Channel Termination rate element for Lightlink Service will vary based on distance. The mileage used to determine the monthly rate for Channel Terminations located outside a Telephone Company central office is the airline distance between the customer's designated premises and the Telephone Company's Serving Wire Center. The mileage measurement is determined by utilizing exchange maps and mileage tables located in designated Company offices for such purposes.

(3) Intraexchange channels furnished between Telephone Company central offices will be charged at rates based on airline distance between the central offices. Interexchange channels will be charged at rates based on airline distance between Telephone Company central offices. Fractional mileage will be rounded up to the next full mile.

(4) Whenever facilities are provided jointly by the Telephone Company and another telephone company, the regulations, rates and charges of the other telephone company shall apply for the equipment and facilities furnished by the other telephone company for use in connection with Lightlink Service. The Telephone Company applies a 50% billing percentage to the Channel Mileage Termination (fixed) rate on jointly owned circuits, and applies 100% on wholly owned circuits. When the Channel Mileage Facility (per mile) is zero (i.e., collocated Serving Wire Centers), neither the Channel Mileage Facility (per mile) rate nor the Channel Mileage Termination (fixed) rate will apply.

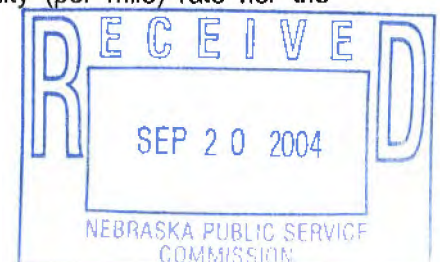

ISSUED:
September 20, 2004

BY: Warren D. Hannah
Director, Tariffs

EFFECTIVE:
September 30, 2004

GENERAL EXCHANGE TARIFF

UNITED TELEPHONE COMPANY OF THE WEST
 d/b/a CENTURYLINK
 NEBRASKA

Section 28
 Third Revised Sheet 28
 Cancels Second Revised Sheet 28

LINK SERVICES

A. LINK SERVICES (Cont'd)

7. RATES AND CHARGES

	<u>Monthly Rate</u>	<u>Nonrecurring Charge Installation</u>	<u>Nonrecurring Charge Rearrangement</u>
a. Channel Termination - Per Point of Termination			
(1) Digilink Service – GRANDFATHERED ^[1]			(C)
19.2 Kbps			
Month to Month	\$106.90	\$312.35	\$150.00
12 - 23 Months	102.00	312.35	150.00
24 - 35 Months	99.00	312.35	150.00
36 - 59 Months	95.00	312.35	150.00
60 - 84 Months	87.00	312.35	150.00
56.0 Kbps, 64.0 Kbps			
Month to Month	\$115.00	\$340.94	\$150.00
12 - 23 Months	102.00	340.94	150.00
24 - 35 Months	99.00	340.94	150.00
36 - 59 Months	95.00	340.94	150.00
60 - 84 Months	87.00	340.94	150.00

^[1] Effective September 1, 2020, this Link Service is grandfathered. Availability to current customers is limited to lines in service at existing locations. (N)
 (N)

ISSUED:
 August 20, 2020

BY: Darlene Terry
 Manager, Tariffs

EFFECTIVE:
 September 1, 2020

NE 2020-12

Received by NPSC
 08/20/2020

GENERAL EXCHANGE TARIFF

UNITED TELEPHONE COMPANY OF THE WEST
d/b/a CENTURYLINK
NEBRASKA

Section 28
Third Revised Sheet 29
Cancels Second Revised Sheet 29

LINK SERVICES

A. LINK SERVICES (Cont'd)

7. RATES AND CHARGES (Cont'd)

	<u>Monthly Rate</u>	<u>Nonrecurring Charge Installation</u>	<u>Nonrecurring Charge Rearrangement</u>	
a. Channel Termination (Cont'd) - Per Point of Termination				
(2) Translink Service				
128 Kbps – GRANDFATHERED ^[1]				(C)
Month to Month	\$119.00	\$295.00	\$200.00	
12 - 23 Months	118.00	295.00	200.00	
24 - 35 Months	117.00	295.00	200.00	
36 - 59 Months	116.00	295.00	200.00	
60 - 84 Months	115.00	295.00	200.00	
256 Kbps – GRANDFATHERED ^[1]				(C)
Month to Month	128.16	295.00	200.00	
12 - 23 Months	122.00	295.00	200.00	
24 - 35 Months	119.00	295.00	200.00	
36 - 59 Months	117.00	295.00	200.00	
60 - 84 Months	115.00	295.00	200.00	
384 Kbps – GRANDFATHERED ^[1]				(C)
Month to Month	136.52	295.00	200.00	
12 - 23 Months	130.00	295.00	200.00	
24 - 35 Months	127.00	295.00	200.00	
36 - 59 Months	124.00	295.00	200.00	
60 - 84 Months	119.00	295.00	200.00	
512 Kbps – GRANDFATHERED ^[1]				(C)
Month to Month	182.00	295.00	200.00	
12 - 23 Months	173.00	295.00	200.00	
24 - 35 Months	169.00	295.00	200.00	
36 - 59 Months	166.00	295.00	200.00	
60 - 84 Months	159.00	295.00	200.00	
1.544 Mbps				
Month to Month	215.00	362.17	200.00	
12 - 23 Months	197.00	362.17	200.00	
24 - 35 Months	193.00	362.17	200.00	
36 - 59 Months	156.00	362.17	200.00	
60 - 84 Months	125.00	362.17	200.00	

^[1] **Effective September 1, 2020, this Link Service is grandfathered. Availability to current customers is limited to lines in service at existing locations.** (N)
(N)

ISSUED:
August 20, 2020

BY: Darlene Terry
Manager, Tariffs

EFFECTIVE:
September 1, 2020

NE2020-12

Received by NPSC
08/20/2020

GENERAL EXCHANGE TARIFF

UNITED TELEPHONE COMPANY
OF THE WEST
NEBRASKA

Section 28
Second Revised Sheet 30
Cancels First Revised Sheet 30

LINK SERVICES

A. LINK SERVICES (Cont'd)

7. RATES AND CHARGES (Cont'd)

	<u>Monthly Rate</u>	<u>Nonrecurring Charge Installation</u>	<u>Nonrecurring Charge Rearrangement</u>	
a. Channel Termination (Cont'd) - Per Point of Termination				
(3) Lightlink Service				
44.736 Mbps				
Month to Month ⁽¹⁾				
Within CO	\$1,395.00	N/A	\$250.00	
0-3 miles	1,745.00 1,695.00	N/A	250.00	(1)
Over 3 miles	2,695.00 2,595.00	N/A	250.00	(1)
12 - 23 Months				
Within CO	1,195.00	\$900.00	250.00	
0-3 miles	1,495.00	900.00	250.00	
Over 3 miles	2,395.00	900.00	250.00	
24 - 35 Months				
Within CO	1,095.00	800.00	250.00	
0-3 miles	1,395.00	850.00	250.00	
Over 3 miles	2,295.00	850.00	250.00	
36 - 59 Months				
Within CO	1,045.00	700.00	250.00	
0-3 miles	1,345.00	800.00	250.00	
Over 3 miles	2,195.00	800.00	250.00	
60 - 84 Months				
Within CO	945.00	500.00	250.00	
0-3 miles	1,245.00	600.00	250.00	
Over 3 miles	1,995.00	600.00	250.00	

30 2008

Comm. Dept.

⁽¹⁾ Month-to-month rates are available only after the expiration of one of the Term Discount Plans.

GENERAL EXCHANGE TARIFF

UNITED TELEPHONE COMPANY OF THE WEST
d/b/a CENTURYLINK
NEBRASKA

Section 28
Third Revised Sheet 31
Cancels Second Revised Sheet 31

LINK SERVICES

A. LINK SERVICES (Cont'd)

7. RATES AND CHARGES (Cont'd)

	<u>Monthly Rate</u>	<u>Nonrecurring Charge</u>	
b. Channel Mileage			
(1) Termination (Fixed) - Per Circuit			
(a) Digilink Service – GRANDFATHERED ⁽¹⁾			(C)
19.2 Kbps, 56.0 Kbps, 64.0 Kbps			
Month to Month	\$51.00	\$0.00	
12 - 23 Months	48.00	0.00	
24 - 35 Months	47.00	0.00	
36 - 59 Months	38.00	0.00	
60 - 84 Months	30.00	0.00	
(b) Translink Service			
128 Kbps – GRANDFATHERED ⁽¹⁾			(C)
Month to Month	\$73.14	\$0.00	
12 - 23 Months	73.14	0.00	
24 - 35 Months	73.14	0.00	
36 - 59 Months	73.14	0.00	
60 - 84 Months	73.14	0.00	
256 Kbps – GRANDFATHERED ⁽¹⁾			(C)
Month to Month	\$74.84	\$0.00	
12 - 23 Months	74.84	0.00	
24 - 35 Months	74.84	0.00	
36 - 59 Months	74.84	0.00	
60 - 84 Months	74.84	0.00	
384 Kbps – GRANDFATHERED ⁽¹⁾			(C)
Month to Month	\$78.25	\$0.00	
12 - 23 Months	78.25	0.00	
24 - 35 Months	78.25	0.00	
36 - 59 Months	78.25	0.00	
60 - 84 Months	78.25	0.00	

⁽¹⁾ **Effective September 1, 2020, this Link Service is grandfathered. Availability to current customers is limited to lines in service at existing locations.** (N)
(N)

ISSUED:
August 20, 2020

BY: Darlene Terry
Manager, Tariffs

EFFECTIVE:
September 1, 2020

NE2020-12

Received by NPSC
08/20/2020

GENERAL EXCHANGE TARIFF

UNITED TELEPHONE COMPANY OF THE WEST
d/b/a CENTURYLINK
NEBRASKA

Section 28
Third Revised Sheet 32
Cancels Second Revised Sheet 32

LINK SERVICES

A. LINK SERVICES (Cont'd)

7. RATES AND CHARGES (Cont'd)

	<u>Monthly Rate</u>	<u>Nonrecurring Charge</u>	
b. Channel Mileage (Cont'd)			
(1) Termination (Fixed) (Cont'd) - Per Circuit			
(b) Translink Service (Cont'd)			
512 Kbps – GRANDFATHERED ⁽¹⁾			(C)
Month to Month	\$146.00	\$0.00	
12 - 23 Months	139.00	0.00	
24 - 35 Months	136.00	0.00	
36 - 59 Months	110.00	0.00	
60 - 84 Months	89.00	0.00	
1.544 Mbps			
Month to Month	\$150.00	\$0.00	
12 - 23 Months	139.00	0.00	
24 - 35 Months	136.00	0.00	
36 - 59 Months	110.00	0.00	
60 - 84 Months	89.00	0.00	
(c) Lightlink Service			
44.736 Mbps			
Month to Month ⁽²⁾	\$725.00	\$0.00	
12 - 23 Months	650.00	0.00	
24 - 35 Months	645.00	0.00	
36 - 59 Months	640.00	0.00	
60 - 84 Months	630.00	0.00	

⁽¹⁾ **Effective September 1, 2020, this Link Service is grandfathered. Availability to current customers is limited to lines in service at existing locations.** (N)
(N)

⁽²⁾ Month-to-month rates are available only after the expiration of one of the Term Discount Plans. (T)

ISSUED:
August 20, 2020

BY: Darlene Terry
Manager, Tariffs

EFFECTIVE:
September 1, 2020

NE2020-12

Received by NPSC
08/20/2020

GENERAL EXCHANGE TARIFF

UNITED TELEPHONE COMPANY OF THE WEST
d/b/a CENTURYLINK
NEBRASKA

Section 28
Third Revised Sheet 33
Cancels Second Revised Sheet 33

LINK SERVICES

A. LINK SERVICES (Cont'd)

7. RATES AND CHARGES (Cont'd)

	<u>Monthly Rate</u>	<u>Nonrecurring Charge</u>	
b. Channel Mileage (Cont'd)			
(2) Facility (Per Mile)			
(a) Digilink Service – GRANDFATHERED ^[1]			(C)
19.2 Kbps, 56.0 Kbps, 64.0 Kbps			
Month to Month	\$2.10	\$0.00	
12 - 23 Months	1.90	0.00	
24 - 35 Months	1.86	0.00	
36 - 59 Months	1.50	0.00	
60 - 84 Months	1.35	0.00	
(b) Translink Service			
128 Kbps – GRANDFATHERED ^[1]			(C)
Month to Month	\$6.60	\$0.00	
12 - 23 Months	6.60	0.00	
24 - 35 Months	6.60	0.00	
36 - 59 Months	6.60	0.00	
60 - 84 Months	6.60	0.00	
256 Kbps – GRANDFATHERED ^[1]			(C)
Month to Month	\$9.50	\$0.00	
12 - 23 Months	9.50	0.00	
24 - 35 Months	9.50	0.00	
36 - 59 Months	9.05	0.00	
60 - 84 Months	7.25	0.00	
384 Kbps – GRANDFATHERED ^[1]			(C)
Month to Month	\$12.00	\$0.00	
12 - 23 Months	11.40	0.00	
24 - 35 Months	11.16	0.00	
36 - 59 Months	9.05	0.00	
60 - 84 Months	7.25	0.00	

^[1] **Effective September 1, 2020, this Link Service is grandfathered. Availability to current customers is limited to lines in service at existing locations.** (N)
(N)

ISSUED:
August 20, 2020

BY: Darlene Terry
Manager, Tariffs

EFFECTIVE:
September 1, 2020

NE2020-12

Received by NPSC
08/20/2020

GENERAL EXCHANGE TARIFF

UNITED TELEPHONE COMPANY OF THE WEST
 d/b/a CENTURYLINK
 NEBRASKA

Section 28
 Third Revised Sheet 34
 Cancels Second Revised Sheet 34

LINK SERVICES

A. LINK SERVICES (Cont'd)

7. RATES AND CHARGES (Cont'd)

	<u>Monthly Rate</u>	<u>Nonrecurring Charge</u>	
b. Channel Mileage (Cont'd)			
(2) Facility (Per Mile) (Cont'd)			
(b) Translink Service (Cont'd)			
512 Kbps – GRANDFATHERED ⁽¹⁾			(C)
Month to Month	\$12.00	\$0.00	
12 - 23 Months	11.40	0.00	
24 - 35 Months	11.16	0.00	
36 - 59 Months	9.05	0.00	
60 - 84 Months	7.25	0.00	
1.544 Mbps			
Month to Month	\$12.50	\$0.00	
12 - 23 Months	11.40	0.00	
24 - 35 Months	11.16	0.00	
36 - 59 Months	9.05	0.00	
60 - 84 Months	7.25	0.00	
(c) Lightlink Service			
44.736 Mbps			
Month to Month ⁽²⁾	\$145.00	N/A	(T)
12 - 23 Months	130.00	\$0.00	
24 - 35 Months	115.00	0.00	
36 - 59 Months	100.00	0.00	
60 - 84 Months	85.00	0.00	

⁽¹⁾ **Effective September 1, 2020, this Link Service is grandfathered. Availability to current customers is limited to lines in service at existing locations.** (N)
 (N)

⁽²⁾ Month-to-month rates are available only after the expiration of one of the Term Discount Plans. (T)

ISSUED:
 August 20, 2020

BY: Darlene Terry
 Manager, Tariffs

EFFECTIVE:
 September 1, 2020

NE2020-12

Received by NPSC
 08/20/2020

GENERAL EXCHANGE TARIFF

UNITED TELEPHONE COMPANY
OF THE WEST
NEBRASKA

Section 28
First Revised Sheet 35
Cancels Original Sheet 35

LINK SERVICES

A. LINK SERVICES (Cont'd)

7. RATES AND CHARGES (Cont'd)

	<u>Monthly Rate</u>	<u>Nonrecurring Charge</u>	
c. Optional Features and Functions			
(1) Translink Service			(T)
(a) Central Office Multiplexing DS1 to DS0 - Per Arrangement			
Month to Month	\$400.00	\$158.82	
12 – 23 Months	375.00	125.00	
24 – 35 Months	350.00	125.00	
36 – 59 Months	305.00	125.00	
60 – 84 Months	255.00	125.00	
(b) Clear Channel Capability (CCC) - Per Channel Termination	\$0.00	\$320.00	
(c) Extended Superframe Format (ESF) - Per Channel Termination	N/A	N/A	
(d) Multiplexed Service Connection - Per DS0	\$8.00	\$50.00	
(2) Lightlink Service			(T)
(a) Central Office Multiplexing DS3 to DS1 - Per Arrangement			
Month to Month ¹	\$475.00	N/A	
12 – 23 Months	475.00	\$115.00	
24 – 35 Months	475.00	115.00	
36 – 59 Months	475.00	115.00	
60 – 84 Months	475.00	115.00	
(b) Clear Channel Capability (CCC) ² - Per Channel Termination	\$0.00	\$275.00	
(c) Multiplexed Service Connection - Per DS1	\$8.00	\$55.00	

¹Month-to-month rates are available only after the expiration of one of the Term Discount Plans.

² A nonrecurring charge will apply when Clear Channel Capability is ordered for a DS1 circuit already in service and will not apply when provided as part of the initial installation.

ISSUED:
September 20, 2004

BY: Warren D. Hannah
Director, Tariffs

EFFECTIVE:
September 30, 2004



GENERAL EXCHANGE TARIFF

UNITED TELEPHONE COMPANY OF THE WEST
 d/b/a CENTURYLINK
 NEBRASKA

Section 28
 Second Revised Sheet 36
 Cancels First Revised Sheet 36

LINK SERVICES

A. LINK SERVICES (Cont'd)

7. RATES AND CHARGES (Cont'd)

	<u>Monthly Rate</u>	<u>Nonrecurring Charge</u>	
d. Data Amplification ^[1] - Per Repeater	\$85.00	\$100.00	(T)
e. Central Office Bridging Capability ^[1] - Per Port			(T)
19.2 Kbps, 56.0 Kbps, 64.0 Kbps – GRANDFATHERED ^[2]			(C)
Month to Month	\$12.00	\$93.82	
12 - 23 Months	12.00	93.82	
24 - 35 Months	12.00	93.82	
36 - 59 Months	12.00	93.82	
60 - 84 Months	12.00	93.82	

^[1] Circuit Repeater and Central Office Bridging Capability only apply to Digilink Service (T)

^[2] **Effective September 1, 2020, this Link Service is grandfathered. Availability to current customers is limited to lines in service at existing locations.** (N)
 (N)

ISSUED:
 August 20, 2020

BY: Darlene Terry
 Manager, Tariffs

EFFECTIVE:
 September 1, 2020

NE2020-12

LONG DISTANCE MESSAGE TELECOMMUNICATIONS SERVICE

(T)

1. The United Telephone Company of the West, hereinafter called the concurring company, except as specifically stated herein, assents to, adopts and concurs in the Long Distance Message Telecommunications Service Tariff, filed with the Nebraska Public Service Commission by the Northwestern Bell Telephone Company, hereinafter called the issuing company, as such tariff now exists, or as it may be revised, added to or supplemented by superseding sheets or issues, for Long Distance Message Telecommunications Service furnished by the issuing company and the concurring company (including such services as are also participated in by one or more other companies), and hereby makes itself a party thereto and obligates itself to observe each and every provision thereof.

(T)

(T)

2. Exceptions

A. Customer-provided terminal equipment or customer-provided communication systems attached or connected to the facilities of this concurring company shall be in compliance with provisions of the Local and General Exchange Tariff of this concurring company.

5033

GENERAL EXCHANGE TARIFF

UNITED TELEPHONE COMPANY
OF THE WEST
NEBRASKA

Section 30
First Revised Sheet 1
Canceling Original Sheet 1

(Reserved for future use)

(D)

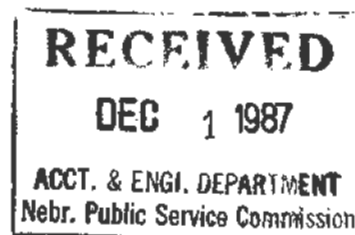

ISSUED:

BY: I. B. Watson
Vice President - Administration
6666 West 110th Street
Overland Park, Kansas 66211

EFFECTIVE:

GENERAL EXCHANGE TARIFF

UNITED TELEPHONE COMPANY
OF THE WEST
NEBRASKA

Section 31

Original Sheet 1

SERVICE THROUGH MISCELLANEOUS COMMON CARRIERS

A. GENERAL

1. Service is available to and from customers of Miscellaneous Common Carriers (MCC), also known as Radio Common Carriers, through connecting facilities provided by the Company in accordance with the provisions set forth herein.
2. Subject to the availability of facilities and the reasonable requirements of the Company for its telecommunications services, the Company will, at the MCC's request, extend and physically connect its facilities with those of the MCC for the purpose of interchanging traffic in connection with the MCC's Domestic Public Land Mobile Radio Services. Such connection and interchange of traffic shall be as follows.
 - a. Two-Way Mobile Traffic

The Company will extend and connect its facilities between the telephone exchange whose rate center is located in the MCC's Reliable Service Area* and the MCC's control point(s) in or serving that reliable service area.
 - b. One-Way Signaling Traffic

The Company will extend and connect its facilities between the telephone exchange within which a signaling receiver is served by the MCC's system and the MCC's control point(s) in or serving that system.
3. The facilities provided for connection and interchange of traffic shall not be used, switched or otherwise connected together by the MCC for the provision of through calling from a landline telephone to another landline telephone, nor shall they be switched or otherwise connected together by the MCC for the provision of through calling from a landline or mobile unit located in one reliable service area* to a landline telephone or mobile unit in another reliable service area*.

* MCC's Reliable Service Area is described in Part 22 of the FCC's Rules and Regulations, Section 22.504.

ISSUED: JUL 23 1985

BY: I. B. Watson
Vice President - Administration
6666 West 110th Street
Overland Park, Kansas 66211

EFFECTIVE: JUL 23 1985

GENERAL EXCHANGE TARIFF

UNITED TELEPHONE COMPANY
OF THE WEST
NEBRASKA

Section 31
Original Sheet 2

SERVICE THROUGH MISCELLANEOUS COMMON CARRIERS

A. GENERAL (Cont'd)

4. Specific administrative procedures, connection and operating arrangements and charges for the facilities provided by the Company to the MCC's for the purpose of connection and interchanging traffic, i.e., liability, use of service, payments of charges and deposits, allowance for interruptions, maintenance of service charge, and interference or impairment, are as set forth in other sections of this tariff. Where the state franchise area or state authorization of the MCC is different from the reliable service area*, the terms and conditions of connection and interchange of traffic may be modified to recognize the extent of such state franchise or authorization.
5. The connection and interchange of traffic as set forth in I.A. through I.D. preceding does not constitute a joint undertaking with the MCC for the furnishing of any service. The Company shall be responsible only for the installation, operation, and maintenance of its facilities. Company facilities are not represented as adapted to the use of other than Company provided equipment or services. The responsibility of the Company shall be limited to the provision of facilities under this tariff and to the maintenance and operation of such facilities in a proper manner.
6. Telephone numbers associated with this service are the property of the Company. However, during the period(s) of time these numbers are assigned to a MCC, the MCC will have the responsibility of permitting his clients to use these numbers in the directory(s) published by the Company.
7. The MCC is responsible and must provide for the intercepting of unused numbers assigned for his use.
8. The minimum contract period for each block of 10 or 100 numbers assigned to the MCC is 60 months.

* MCC's Reliable Service Area is described in Part 22 of the FCC's Rules and Regulations, Section 22.504.

ISSUED: JUL 23 1985

EFFECTIVE: JUL 23 1985

BY: I. B. Watson
Vice President - Administration
6666 West 110th Street
Overland Park, Kansas 66211

GENERAL EXCHANGE TARIFF

UNITED TELEPHONE COMPANY
OF THE WEST d/b/a CenturyLink
NEBRASKA

Section 32
Sixth Revised Sheet 1
Cancels Fifth Revised Sheet 1

OPERATOR SERVICES

A. DIRECTORY ASSISTANCE (D.A.) SERVICE

1. General

- a. The Company furnishes local, long distance and national directory assistance whereby customers may request assistance in determining telephone numbers or names associated with directory listings of individuals and/or businesses. Where technically feasible, customers may have their calls to the requested telephone number completed by the automated directory assistance system.
- b. A Directory Assistance Service Charge applies when customers request assistance in determining telephone numbers or names in the local calling area in which the customer receives local exchange service (local directory assistance), telephone numbers or names located outside the local calling area but within the customer's Home Numbering Plan Area (HNPA) (long distance directory assistance), or telephone numbers or names that are located outside the customer's HNPA (national directory assistance).
- c. Directory assistance call completion is provided with directory assistance at no additional charge where technically feasible. Customers who dial directory assistance service may choose to have the requested telephone number automatically dialed and the call completed by the automated directory assistance system. When the customer receives the requested directory number from the automated directory assistance system, the customer will hear the directory assistance call completion announcement prompt offering to automatically dial the requested number. The customer will be prompted to activate directory assistance call completion by depressing a specific digit on a touch-tone telephone during the directory assistance call completion announcement prompt. Directory assistance call completion is not available when requesting the name associated with a directory listing.

2. Regulations

- a. A maximum of two telephone numbers or names will be provided per directory assistance call. If two telephone numbers or names are requested in a single directory assistance call, directory assistance call completion is available only for the second telephone number provided.
- b. Directory assistance call completion is not available to the following customer groups:
 - Hospitals
 - Hotels/Motels
 - Prisons/Inmates
 - Interexchange Carriers
 - Mobile
 - Payphone Line Service
- c. Directory Assistance is not available to customers subscribed to Toll and Casual Dialing Restriction Service.

(D)

ISSUED:
November 30, 2018

BY: Darlene Terry
Manager, Tariffs

EFFECTIVE:
December 10, 2018

GENERAL EXCHANGE TARIFF

UNITED TELEPHONE COMPANY
OF THE WEST d/b/a CenturyLink
NEBRASKA

Section 32
Sixth Revised Sheet 1.1
Cancels Fifth Revised Sheet 1.1

OPERATOR SERVICES

A. DIRECTORY ASSISTANCE (D.A.) SERVICE (Cont'd)

3. Exemptions

- a. There are no call exemptions or allowances for Directory Assistance Service except as specified in 3.b following.
- b. Charges for local and long distance Directory Assistance Service are not applicable to calls placed from payphone line service, hospitals and customers (residence telephone numbers) who certify that they are unable to use a directory because of a physical, visual or mental handicap. Handicapped customers may obtain this exemption upon their completion and submission of an exemption form supplied by the Company, and the Company's acceptance of that form. There are no exemptions for national directory assistance calls.

4. Rate Regulations

- a. The Directory Assistance Service Charge applies per call even if the customer requests telephone numbers or names that are not published or otherwise not found by the operator or automated directory assistance system, or if the call is not completed by the automated directory assistance system (i.e., busy, no answer, customer does not invoke directory assistance call completion or directory assistance call completion is not available).
- b. In locations where the customer has the technical capability to direct dial Directory Assistance but places the call by dialing "0", Operator Handled Service Charges will apply in addition to the Directory Assistance Service Charge as specified in 5.b following.

5. Rates

- a. Directory Assistance Service Charge,
per Directory Assistance call **\$6.99**
- b. When the customer requests Directory Assistance by dialing "0" where the customer has the technical capability to direct dial Directory Assistance, the Operator Assisted Station-to-Station rate specified in Section 32 applies in addition to the Directory Assistance Service Charge.
- c. Applicable usage charges will apply for completed toll calls in addition to the Directory Assistance Service charge.

ISSUED:
January 15, 2019

BY: Chantel Bosworth
Director, Tariffs

EFFECTIVE:
February 1, 2020

NE2021-03

Received by NPSC
01/15/2021

GENERAL EXCHANGE TARIFF

UNITED TELEPHONE COMPANY
OF THE WEST
NEBRASKA

Section 32
Third Revised Sheet 5
Cancels Second Revised Sheet 5

OPERATOR SERVICES

D. OPERATOR INTERCEPT SERVICES (Cont'd)

1. General (Cont'd)

- e. CUSTOMIZED INTERCEPT SERVICE provides announcement of the new number plus a customized message by live operator.
- f. Operator Intercept Services are subject to availability of facilities and provided at **the Company's** discretion for the twelve month period beginning January 1, 1989 and ending December 31, 1989 (excluding Basic Intercept Service). (T)
- g. Intercept Services are provided to residence and business customers for a minimum of 1 month and up to 6 months.
- h. Intercept Service is applicable to temporarily or permanently disconnected numbers including telephone number changes.
- i. Rates exclude Advanced Business Connections, PBX-DID, and 800 service. Intercept rates for these services will be provided on an individual case basis.
- j. Established service ordering charges apply in addition to the rates for Intercept Services.
- k. **The Company** retains the right to refuse any Intercept message, and will be held harmless from any claims which may arise out of the Company's provision of the Intercept message. (T)
- l. The Customized Intercept Service message consists of:
 - * Name of customer;
 - * New telephone number;
 - * Message of thirty words or less. Added messages will be provided at an additional charge.

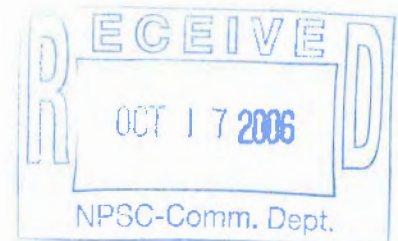

ISSUED:
October 18, 2006

BY: Darlene Terry
Manager, Tariffs

EFFECTIVE:
October 28, 2006

GENERAL EXCHANGE TARIFF

UNITED TELEPHONE COMPANY
OF THE WEST
NEBRASKA

Section 32
Second Revised Sheet 5
Canceling First Revised Sheet 5

OPERATOR SERVICES

- D. OPERATOR INTERCEPT SERVICES (Cont'd) (T)
1. General (Cont'd) (T)
- e. CUSTOMIZED INTERCEPT SERVICE provides announcement of the new number plus a customized message by live operator.
 - f. Operator Intercept Services are subject to availability of facilities and provided at United's discretion for the twelve month period beginning January 1, 1989 and ending December 31, 1989 (excluding Basic Intercept Service).
 - g. Intercept Services are provided to residence and business customers for a minimum of 1 month and up to 6 months.
 - h. Intercept Service is applicable to temporarily or permanently disconnected numbers including telephone number changes.
 - i. Rates exclude Advanced Business Connections, PBX-DID, and 800 service. Intercept rates for these services will be provided on an individual case basis.
 - j. Established service ordering charges apply in addition to the rates for Intercept Services.
 - k. United retains the right to refuse any Intercept message, and will be held harmless from any claims which may arise out of the Company's provision of the Intercept message.
 - l. The Customized Intercept Service message consists of:
 - * Name of customer;
 - * New telephone number;
 - * Message of thirty words or less. Added messages will be provided at an additional charge.

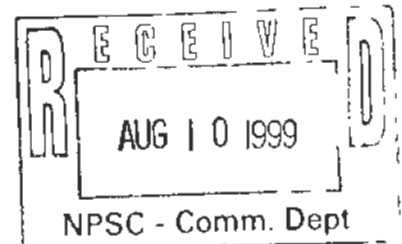

ISSUED:
August 10, 1999

BY: Warren D. Hannah
Director, Local Tariffs

EFFECTIVE:
August 20, 1999

GENERAL EXCHANGE TARIFF

UNITED TELEPHONE COMPANY
OF THE WEST
NEBRASKA

Section 32
Second Revised Sheet 6
Canceling First Revised Sheet 6

OPERATOR SERVICES

D. OPERATOR INTERCEPT SERVICES (Cont'd) (T)

2. Rates

		<u>RESIDENCE</u>	<u>CHARGE</u>	<u>BUSINESS</u>	
a.	BASIC	None		None	(T)
b.	NEW NUMBER REFERRAL				(T)
	- one month	\$ 5.00		\$10.00	
	- two months	10.00		20.00	
	- each additional month	4.00*		8.00*	
c.	SPLIT REFERRAL - TWO NUMBERS				(T)
	- one month	\$10.00		\$20.00	
	- two months	20.00		40.00	
	- each additional month	8.00*		16.00*	
	- Additional numbers at \$3 a month per number				
d.	CUSTOMIZED				(T)
	- one month	\$15.00		\$30.00	
	- two months	30.00		60.00	
	- each additional month	12.00*		24.00*	
	- Additional messages at \$10 a month per message				

* In addition to the appropriate two months rate.

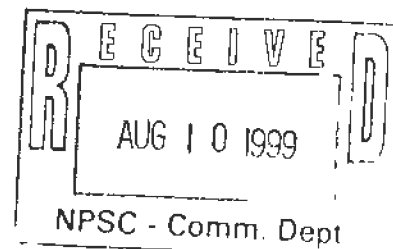

ISSUED:
August 10, 1999

BY: Warren D. Hannah
Director, Local Tariffs

EFFECTIVE:
August 20, 1999

GENERAL EXCHANGE TARIFF

UNITED TELEPHONE COMPANY
OF THE WEST
NEBRASKA

Section 32
First Revised Sheet 7
Cancels Original Sheet 7

OPERATOR SERVICES

(D)

(D)

ISSUED:
October 1, 2004

BY: Warren D. Hannah
Director, Tariffs

EFFECTIVE:
October 11, 2004



GENERAL EXCHANGE TARIFF

UNITED TELEPHONE COMPANY
OF THE WEST
NEBRASKA

Section 40
Second Revised Sheet A
Canceling First Revised Sheet A

1. The service offerings previously listed on the succeeding pages of this section have been removed from the tariff. (D)
2. This sheet also cancels:

First Revised Index Sheet 1	First Revised Sheet 40
First Revised Index Sheet 2	First Revised Sheet 41
First Revised Sheet 1	First Revised Sheet 42
Second Revised Sheet 2	First Revised Sheet 43
First Revised Sheet 3	First Revised Sheet 44
First Revised Sheet 4	First Revised Sheet 45
First Revised Sheet 5	First Revised Sheet 46
First Revised Sheet 6	First Revised Sheet 47
Second Revised Sheet 7	First Revised Sheet 48
First Revised Sheet 8	First Revised Sheet 49
First Revised Sheet 9	First Revised Sheet 50
Second Revised Sheet 10	
Second Revised Sheet 11	
First Revised Sheet 12	
First Revised Sheet 13	
First Revised Sheet 14	
Original Sheet 15	
First Revised Sheet 16	
First Revised Sheet 17	
First Revised Sheet 18	
First Revised Sheet 19	
Original Sheet 20	
First Revised Sheet 21	
First Revised Sheet 22	
Original Sheet 23	
Original Sheet 24	
Original Sheet 25	
Original Sheet 26	
First Revised Sheet 27	
First Revised Sheet 28	
First Revised Sheet 29	
First Revised Sheet 30	
First Revised Sheet 31	
First Revised Sheet 32	
First Revised Sheet 33	
First Revised Sheet 34	
Original Sheet 35	
Original Sheet 36	
First Revised Sheet 37	
First Revised Sheet 38	
First Revised Sheet 39	

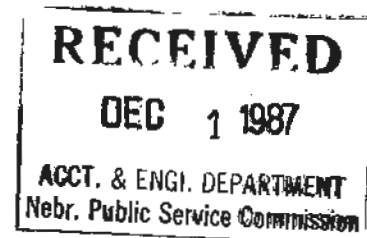

ISSUED:

BY: I. B. Watson
Vice President - Administration
6666 West 110th Street
Overland Park, Kansas 66211

EFFECTIVE:

UNITED TELEPHONE COMPANY OF THE WEST – NEBRASKA d/b/a CENTURYLINK
GENERAL EXCHANGE
PRICE LIST

SECTION Trade names Trademarks Service Marks

PAGE: 1

RELEASE: 5

ISSUED: December 6, 2011

EFFECTIVE: December 16, 2011

Trade Names, Trademarks and Service Marks Used in this Price List

Below is a list of trade names, trademarks and/or service marks for services which are offered in this Price List. These trade names, trademarks and/or service marks are owned by CenturyLink, Inc. or a subsidiary of CenturyLink, Inc. and are used by the Company with express permission. Trademark and service mark designations will not be listed hereafter in the Price List. However, the laws regarding trademarks and service marks will still apply. Trade names, trademarks and service marks that are owned by CenturyLink, Inc. or a subsidiary of CenturyLink, Inc. cannot be used by another party without authorization.

CENTURYLINK
CENTURYLINK™
CENTURYLINKSM
CORE CONNECT®

(N)

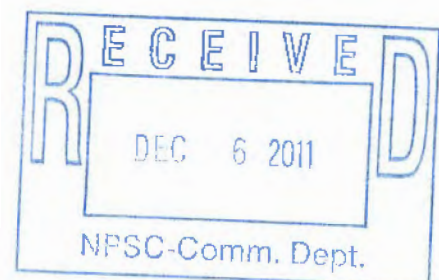

GENERAL EXCHANGE TARIFF

UNITED TELEPHONE COMPANY
OF THE WEST d/b/a CenturyLink
NEBRASKA

GENERAL INDEX
Original Title Page 1

GENERAL EXCHANGE TARIFF

Schedule of Rates and Charges Together
With Rules and Regulations Applicable To
Services Provided In The Territory Served
By This Company Within The State of Nebraska

ADOPTION NOTICE

Effective July 28, 2009, United Telephone Company of the West registered the fictitious name CenturyLink. Effective October 19, 2009, United Telephone Company of the West, began operating under the name CenturyLink. As such, United Telephone Company of the West d/b/a CenturyLink hereby adopts, ratifies, and makes its own, in every respect as if the same had been originally filed by it, all schedules, rules, notices, concurrences, schedule agreements, divisions, authorities or other instruments whatsoever, filed with the Nebraska Public Service Commission, State of Nebraska, by or adopted by United Telephone Company of the West on and before October 18, 2009.

By this notice, United Telephone Company of the West d/b/a CenturyLink also adopts and ratifies all supplements or amendments to any of the above schedules, etc., which United Telephone Company of the West has heretofore filed with said Commission.

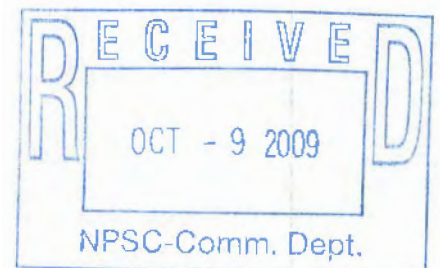

ISSUED:
October 9, 2009

BY: Darlene Terry
Manager, Tariffs

EFFECTIVE:
October 19, 2009

LOCAL EXCHANGE TARIFF

UNITED TELEPHONE COMPANY
OF THE WEST d/b/a CenturyLink
NEBRASKA

Original Title Page 1

LOCAL EXCHANGE TARIFF

Schedule of Rates and Charges Together
With Rules and Regulations Applicable To
Services Provided In The Territory Served
By This Company Within The State of Nebraska

ADOPTION NOTICE

Effective July 28, 2009, United Telephone Company of the West registered the fictitious name CenturyLink. Effective October 19, 2009, United Telephone Company of the West, began operating under the name CenturyLink. As such, United Telephone Company of the West d/b/a CenturyLink hereby adopts, ratifies, and makes its own, in every respect as if the same had been originally filed by it, all schedules, rules, notices, concurrences, schedule agreements, divisions, authorities or other instruments whatsoever, filed with the Nebraska Public Service Commission, State of Nebraska, by or adopted by United Telephone Company of the West on and before October 18, 2009.

By this notice, United Telephone Company of the West d/b/a CenturyLink also adopts and ratifies all supplements or amendments to any of the above schedules, etc., which United Telephone Company of the West has heretofore filed with said Commission.

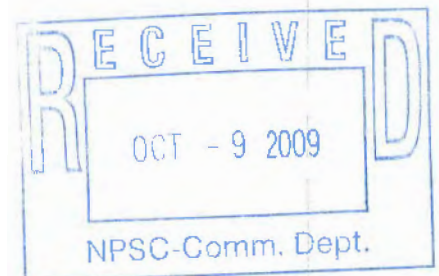

ISSUED:
October 9, 2009

BY: Darlene Terry
Manager, Tariffs

EFFECTIVE:
October 19, 2009

GENERAL EXCHANGE TARIFF

UNITED TELEPHONE COMPANY
OF THE WEST d/b/a CenturyLink
NEBRASKA

GENERAL INDEX
Twenty-Seventh Revised Sheet 2 (C)
Cancels Twenty-Sixth Revised Sheet 2

	<u>SECTION</u>	<u>SHEET</u>	
Initial Service Periods.....	7	1	
Installation Charges and Allowances.....	3	1	
Lifeline Assistance	9	1	
Link Services.....	28	1	
Link Up Nebraska (Service Connection Charges).....	18	11	
Long Distance Message Telecommunications Service	29	1	
Low-Income Connection Assistance (Service Connection Charges)	18	11	
Mileage Charges	8	1	
N11 Service.....	19	1	
National Aeronautics & Space Administration Provided Facilities	23	12	
Natural Disaster Relief for Customers	GRR	9	(N)
Network Protection Criteria	23	20	
Operator Intercept Services	32	4	
Operator Services	32	1	
Optional Local Measured Service	LET	2.1	
Outside Plant Construction	3	1	
Payphone Line Service	15	4	
Pipe Line Company Provided Facilities	23	12	
Power Company Provided Facilities	23	12	
Primary Listings.....	4	2	
Primary Service and Regrades	3	2	
Private Line Service	27	1	
Private Right-of-Way.....	3	3	
Public Emergency Reporting Service	21	1	
Railroad Company Provided Facilities	23	12	
Recorder-Connector for Customer-Provided Equipment.....	23	16a	
Residence Service for Company Employees.....	GRR	8	
Residence Service Rates.....	2	1	

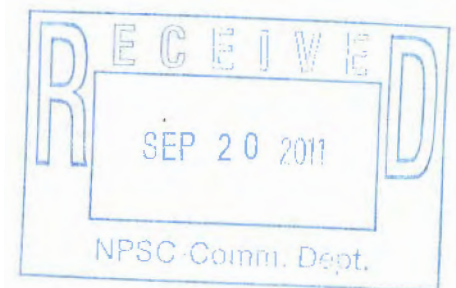

ISSUED:
September 20, 2011

BY: Darlene Terry
Manager, Tariffs

EFFECTIVE:
September 30, 2011

UNITED TELEPHONE COMPANY OF THE WEST d/b/a CenturyLink
NEBRASKA
GENERAL EXCHANGE PRICE LIST

INDEX
PAGE: 1
RELEASE: 34
EFFECTIVE: August 16, 2021

ISSUED: August 6, 2021

<u>TITLE</u>	<u>SECTION</u>	
Integrated Services Digital Network (ISDN)	1	
Special Packaged Offerings	2	
Solutions - Residence		
Solutions – Business		
Solutions II - Business		
Centrex II Service		
Connection Central Bundle		
Primary Rate Interface (PRI) Bundle – Business		
MultiLine Bundle		
Hosted MultiLine Bundle		
Business Assist Advantage Plans		
Prepaid Local Telephone Service Bundles		
Core Connect		
Unlimited Nationwide Calling or Essential Home Phone with 30 Minutes Nationwide Long Distance		
Simply Unlimited Business		(N)
Miscellaneous Services	3	
Satisfaction Guarantee Program		
Voice Business Continuity		
Residence Customer Referral Program		
Reserved For Future Use	4	
Centrex Service	5	
Reserved For Future Use	6	
Reserved For Future Use	7	
Reserved For Future Use	8	
Reserved For Future Use	9	
Reserved For Future Use	10	
Supplemental Services	11	
Maintenance of Service Charge (Customer Provided Equipment)		
Subscriber Transfer Service		
Touch-Tone Service		
Rotary Hunt Service		
Customer Convenience Calling		
Toll and Casual Dialing Restriction Service		
Direct Inward Dialing Functionality		
Direct Inward Dialing Service (DID)		
900 Service Access Restriction		
Bill Number Screening		
Special Monthly Billing		
Call Line Identifier		
Network Services	12	
Custom Calling Features		
ExpressTouch Features		
Digital Trunking Service	13	

NE2021-13

GENERAL EXCHANGE TARIFF

UNITED TELEPHONE COMPANY
OF THE WEST d/b/a CenturyLink
NEBRASKA

Fifth Revised Sheet 8
Cancels Fourth Revised Sheet 8

GENERAL RULES AND REGULATIONS APPLYING TO TELEPHONE SERVICE

TRANSMITTED RECORDED ANNOUNCEMENTS (Cont'd)

- c. Non-published telephone service will not be furnished for use with recorded public announcements.
- d. Failure to comply with the provisions of this Tariff shall be cause for termination of the service.

WAIVER OF INSTALLATION AND/OR SERVICE CONNECTION CHARGES - The Telephone Company may waive the service connection or installation charge for a limited period for new or existing services or products during special promotional periods to existing customer who wish to participate.

These special promotions will be offered on a non-discriminatory basis with each customer in the classification of service and area for which the promotion is offered having an equal opportunity to participation subject to the availability of services and facilities or products.

RESIDENCE SERVICE FOR COMPANY EMPLOYEES - The same rules and regulations are applicable to employees and retirees of the Company as are applicable to the general public. Certain telephone services will be furnished to Company employees and Company retirees at reduced rates as authorized by Company practices and procedures.

TELECOMMUNICATIONS RELAY SURCHARGE - Nebraska law requires that a surcharge be collected on each telephone access line in Nebraska. The surcharge will be remitted to the Nebraska Public Service Commission to establish and administer a fund for a statewide Telecommunications Relay System to be used for eligible communication impaired persons.

This surcharge will be collected on the first one hundred (100) telephone access lines per customer, and appears as a separate line item on the customer's local telephone bill.

a.	Rates	Monthly Rate
	Per Access Line	\$0.05

(1)

ISSUED:
June 21, 2010

BY: Darlene Terry
Manager, Tariffs

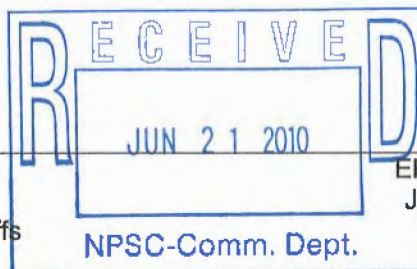

EFFECTIVE:
July 1, 2010

GENERAL EXCHANGE TARIFF

UNITED TELEPHONE COMPANY
OF THE WEST d/b/a CenturyLink
NEBRASKA

Original Sheet 9

GENERAL RULES AND REGULATIONS APPLYING TO TELEPHONE SERVICE

NATURAL DISASTER RELIEF FOR CUSTOMERS

In situations where customers' telecommunications services are interrupted by natural disasters, the Company may offer alternative telecommunications services to customers in the immediate affected area, and waive otherwise applicable charges for those services. The availability and details of the offers, including, but not limited to, the maximum duration of the offer or waiver of any applicable charges, will be determined by the Company in each instance of natural disaster.

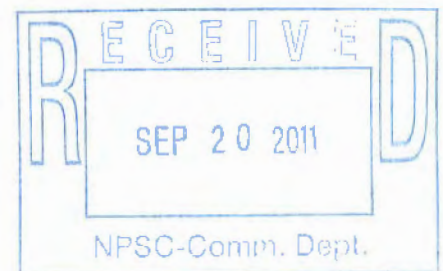

ISSUED:
September 20, 2011

BY: Darlene Terry
Manager, Tariffs

EFFECTIVE:
September 30, 2011

UNITED TELEPHONE COMPANY OF THE WEST d/b/a CENTURYLINK
NEBRASKA
GENERAL EXCHANGE PRICE LIST

SECTION Trade names Trademarks Service Marks

PAGE: 1

RELEASE: 6

ISSUED: May 20, 2021

EFFECTIVE: June 1, 2021

Trade Names, Trademarks and Service Marks Used in this Price List

Below is a list of trade names, trademarks and/or service marks for services which are offered in this Price List. These trade names, trademarks and/or service marks are owned by **Lumen Technologies, Inc. (formerly CenturyLink, Inc.)** or a subsidiary of **Lumen Technologies, Inc.** and are used by the Company with express permission. Trademark and service mark designations will not be listed hereafter in the Price List. However, the laws regarding trademarks and service marks will still apply. Trade names, trademarks and service marks that are owned by **Lumen Technologies, Inc.** or a subsidiary of **Lumen Technologies, Inc.** cannot be used by another party without authorization.

(C)

(C)

(C)

(C)

CENTURYLINK
CENTURYLINK®

(T)

(D)

CORE CONNECT®

UNITED TELEPHONE COMPANY OF THE WEST **d/b/a CenturyLink**
NEBRASKA
GENERAL EXCHANGE PRICE LIST

(C)

TITLE PAGE

PAGE: 1

RELEASE: 2

ISSUED: October 9, 2009

EFFECTIVE: October 19, 2009

GENERAL EXCHANGE PRICE LIST

APPLYING TO

TELEPHONE SERVICE

WITHIN THE

STATE OF NEBRASKA

except as otherwise specifically provided
in the General Rules and Regulations or
Local Exchange Tariff. The
General Rules and Regulations
applying to Telephone Service
apply to the Price List as applicable.

ADOPTION NOTICE

Effective July 28, 2009, United Telephone Company of the West registered the fictitious name CenturyLink. Effective October 19, 2009, United Telephone Company of the West, began operating under the name CenturyLink. As such, United Telephone Company of the West **d/b/a CenturyLink** hereby adopts, ratifies, and makes its own, in every respect as if the same had been originally filed by it, all schedules, rules, notices, concurrences, schedule agreements, divisions, authorities or other instruments whatsoever, filed with the Nebraska Public Service Commission, State of Nebraska, by or adopted by United Telephone Company of the West on and before October 18, 2009.

By this notice, United Telephone Company of the West **d/b/a CenturyLink** also adopts and ratifies all supplements or amendments to any of the above schedules, etc., which United Telephone Company of the West has heretofore filed with said Commission.

(N)

(N)

EXPLANATIONS OF SYMBOLS

- (C) - designates change listing, rule or condition which may affect rates or charges
- (D) - designates discontinued material including any listing, rate, rule or condition
- (I) - designates an increase in the rate
- (L) - designates material relocated from or to another part of tariff schedules with no change in text, rate, rule or condition
- (N) - designates new material including a listing, rate, rule or condition
- (R) - designates a reduction in the rate
- (T) - designates a change in the text with no change in the rate, rule or condition

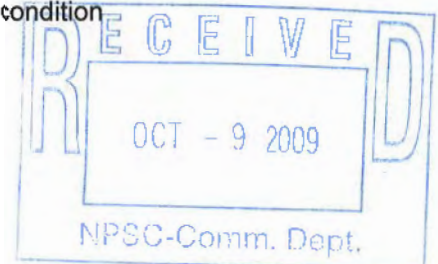

UNITED TELEPHONE COMPANY OF THE WEST d/b/a CenturyLink
NEBRASKA
GENERAL EXCHANGE PRICE LIST

INDEX
PAGE: 1
RELEASE: 35

ISSUED: September 7, 2021

EFFECTIVE: September 18, 2021

<u>TITLE</u>	<u>SECTION</u>	
Integrated Services Digital Network (ISDN)	1	
Special Packaged Offerings	2	
Solutions - Residence		
Solutions – Business		
Solutions II - Business		
Centrex II Service		
Connection Central Bundle		
Primary Rate Interface (PRI) Bundle – Business		
MultiLine Bundle		
Hosted MultiLine Bundle		
Business Assist Advantage Plans		
Prepaid Local Telephone Service Bundles		
Core Connect		
Unlimited Nationwide Calling or Essential Home Phone with 30 Minutes Nationwide Long Distance		
Simply Unlimited Business		
Simply Unlimited Phone for Residence		(N)
Miscellaneous Services	3	
Satisfaction Guarantee Program		
Voice Business Continuity		
Residence Customer Referral Program		
Reserved For Future Use	4	
Centrex Service	5	
Reserved For Future Use	6	
Reserved For Future Use	7	
Reserved For Future Use	8	
Reserved For Future Use	9	
Reserved For Future Use	10	
Supplemental Services	11	
Maintenance of Service Charge (Customer Provided Equipment)		
Subscriber Transfer Service		
Touch-Tone Service		
Rotary Hunt Service		
Customer Convenience Calling		
Toll and Casual Dialing Restriction Service		
Direct Inward Dialing Functionality		
Direct Inward Dialing Service (DID)		
900 Service Access Restriction		
Bill Number Screening		
Special Monthly Billing		
Call Line Identifier		
Network Services	12	
Custom Calling Features		
ExpressTouch Features		
Digital Trunking Service	13	

NE2021-16

UNITED TELEPHONE COMPANY OF THE WEST - NEBRASKA
GENERAL EXCHANGE
PRICE LIST

INDEX
PAGE: 2
RELEASE: 4

ISSUED: September 28, 2004

EFFECTIVE: October 11, 2004

<u>TITLE</u>	<u>SECTION</u>	
United SwitchLink Services - Grandfathered.....	14	(T)
Reserved For Future Use.....	15	
Reserved For Future Use.....	16	
Special Promotions.....	17	
Reserved For Future Use.....	18	
Reserved For Future Use.....	19	
Reserved For Future Use.....	20	
Reserved For Future Use.....	21	
Simplified Message Desk Interface (SMDI).....	22	
Reserved For Future Use.....	23	
Reserved For Future Use.....	24	
Reserved For Future Use.....	25	
Reserved For Future Use.....	26	
Reserved For Future Use.....	27	
Info-Link.....	28	



UNITED TELEPHONE COMPANY OF THE WEST - NEBRASKA
GENERAL EXCHANGE
PRICE LIST

SECTION 1

PAGE: 1

RELEASE: 5

ISSUED: July 18, 2008

EFFECTIVE: July 30, 2008

INTEGRATED SERVICES DIGITAL NETWORK (ISDN)

I. BASIC RATE INTERFACE (BRI) ⁽¹⁾

(C)

A. GENERAL

1. Integrated Services Digital Network - Basic Rate Interface (ISDN-BRI) is a local exchange telecommunications service that provides integrated voice and data communications capability. ISDN-BRI service supports the simultaneous transmission of voice and data over a single exchange access line.

ISDN-BRI provides a customer two B-channels with transmission speeds up to 64 Kbps each and one 16 Kbps D-channel. The service provides switched communication paths providing end user access to a variety of network services and features including data, voice and video, which conforms to internationally developed, published and recognized standards generated by the International Telecommunications Union.

2. Service Capabilities

- a. ISDN-BRI consists of three distinct channels delivered to the customer's premise: two B (bearer) channels and one D (delta) channel. This is also known as 2B+D. ISDN-BRI is not available in other channel configurations of 1B+D or 0B+D.
- b. The B-channel carries voice and data communications at speeds up to 64 Kbps, from the customer's premise, over the loop facility, to the central office. Packet data services are not available over the B-channel.
- c. The D-channel carries administrative signaling at 16 Kbps for call-control for either a voice or data B-channel call on the ISDN-BRI line. The D-channel does not have voice capability. Packet data services are not available on the D-channel.
- d. Customers subscribing to ISDN-BRI must comply with ISDN Basic Rate Network Interface specifications as specified by the Company. The ISDN Basic Rate Interface is comprised of a limited set of standard user-network interfaces. The BRI customer premises equipment (CPE) located at the customer premises must be compatible with the network interface. This interface is defined as follows:

A two-wire interface is the physical interface between a central office switch equipped with ISDN and the customer premises equipment which is necessary for terminating a telephone circuit or facility at the customer premises.

⁽¹⁾ Effective July 30, 2008, this service is no longer available to new residential customers. Existing customers may retain their current service at the same location until such service is changed or discontinued by the customer.

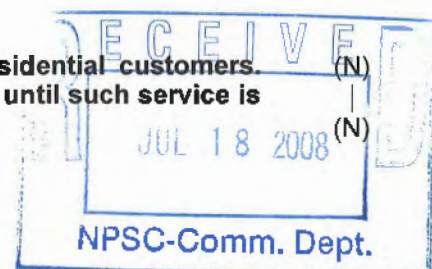

UNITED TELEPHONE COMPANY OF THE WEST - NEBRASKA
GENERAL EXCHANGE
PRICE LIST

SECTION 1

PAGE: 2

RELEASE: 3

ISSUED: July 18, 2008

EFFECTIVE: July 30, 2008

INTEGRATED SERVICES DIGITAL NETWORK (ISDN)

I. BASIC RATE INTERFACE (BRI) ⁽¹⁾ (Cont'd)

(C)

A. GENERAL (Cont'd)

3. Standard Features

- a. Closed User Group – allows the user to establish sub-networks within which the members of the Closed User Group can communicate. Each data terminal in a Closed User Group can be arranged in one of the following modes:

- (1) Outgoing Access – The data terminal originates outgoing calls only.
- (2) Incoming Access – The data terminal receives incoming calls only.
- (3) Incoming Calls Barred – The data terminal originates outgoing calls only to the data terminals in the Closed User Group with which it is associated.
- (4) Outgoing Calls Barred – The data terminal receives incoming calls only from the data terminals in the Closed User Group with which it is associated.
- (5) Unrestricted Access – The data terminal receives and originates both incoming and outgoing calls.

- b. Configuration Group – Associates a button or buttons of an ISDN-CPE station to a feature or group of features. Each different telephone set button arrangement requires that a different Configuration Group be assigned.

4. Service Capability Packages*

- a. Customers shall subscribe to one of the following Service Capability Packages specifying the assignment of each B-channel. Through the North American ISDN Users' Forum, a set of ISDN Service Capability Packages have been defined and given a letter designation. Each of the Service Capability Packages describes a specific interface configuration as well as the features and capabilities of that interface. Detailed technical specifications are defined for each of the Service Capability Packages. These packages have been established to help simplify the ordering, provisioning, and installation of ISDN.

* ISDN terminal equipment is the responsibility of the customer and must support the configuration, optional services and features chosen by the customer.

⁽¹⁾ **Effective July 30, 2008, this service is no longer available to new residential customers. Existing customers may retain their current service at the same location until such service is changed or discontinued by the customer.**

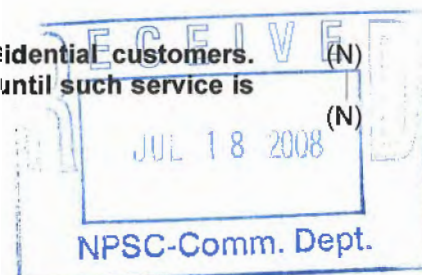

UNITED TELEPHONE COMPANY OF THE WEST - NEBRASKA
GENERAL EXCHANGE
PRICE LIST

SECTION 1
PAGE: 3
RELEASE: 4
EFFECTIVE: July 30, 2008

ISSUED: July 18, 2008

INTEGRATED SERVICES DIGITAL NETWORK (ISDN)

I. BASIC RATE INTERFACE (BRI) ⁽¹⁾ (Cont'd) (C)

A. GENERAL (Cont'd)

4. Service Capability Packages* (Cont'd)

a. **Customers shall subscribe to one of the following ...** (Cont'd) (T)

- (1) Standard ISDN-BRI (equivalent to Package S without features)
1-B Alternate voice data
1-B Alternate voice data

Key Telephone Systems

ISDN may be purchased for a key system from this tariff in the place of a key trunk (for ISDN-capable key systems). If terminating an ISDN-BRI line into key system, the customer shall order one of the following Service Capability Packages:

- (2) Package H:
1-B Voice Only
1-B data only
(Includes Additional Call Offering)
- (3) Package L:
1-B data only
1-B Alternate voice data
(Includes Additional Call Offering)

5. Optional Services and Features*

a. The ISDN-BRI offering provides the customer with the following features, where available.

- (1) Call Pickup – Originating and Terminating – This feature allows a station user to answer any call within an associated predesignated pickup group. If more than one line within the pickup group has an unanswered incoming call, the call to be answered is selected by the central office switching system.
- (2) Flexible Calling – This feature includes:
Hold/Retrieve*
B-Channel Reservation
Three-Way Conference Calling
Add-on (previously held conference call)
Drop Last Call
Transfer
No Transfer Restriction
Consultation Hold

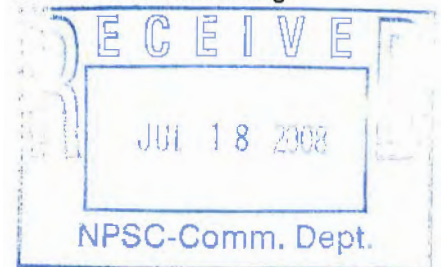

* ISDN terminal equipment is the responsibility of the customer and must support the configuration, optional services and features chosen by the customer.

⁽¹⁾ **Effective July 30, 2008, this service is no longer available to new residential customers. Existing customers may retain their current service at the same location until such service is changed or discontinued by the customer.**

(N)
|
(N)

UNITED TELEPHONE COMPANY OF THE WEST - NEBRASKA
GENERAL EXCHANGE
PRICE LIST

SECTION 1
PAGE: 4
RELEASE: 4

ISSUED: July 18, 2008

EFFECTIVE: July 30, 2008

INTEGRATED SERVICES DIGITAL NETWORK (ISDN)

1. BASIC RATE INTERFACE (BRI) ⁽¹⁾ (Cont'd) (C)

A. GENERAL (Cont'd)

5. Optional Services and Features* (Cont'd)

a. **Customers shall subscribe to one of the following ...** (Cont'd) (T)

- (3) Six-Way Conference Calling, Drop, Hold, Transfer – This feature allows the customer to add up to five parties to an existing call. This feature is for voice calls only.
- (4) Automatic Callback (Repeat Dial) – This feature provides automatic callback to the last dialed number.
- (5) Additional Call Offering (ACO) – This feature allows multiple call appearances per telephone number (B-channel) per telephone set. Example: A customer can put up to 3 calls on hold and receive another call on the phone, with all calling parties dialing the telephone number associated with voice on B-channel.
- (6) Call Forwarding – This feature provides the customer with Call Forwarding Variable, Call Forwarding Busy and Call Forwarding No Answer with message waiting indicator, either visual or audible.
- (7) Calling Number Identification – This feature permits the customer to receive and display the calling party telephone number for calls placed to the customer.
- (8) Calling Name Identification – This feature permits the customer to receive and display the calling party name for calls placed to the customer.
- (9) Additional Directory Numbers – Additional directory numbers are available on each B-channel in addition to the primary directory number assigned to the B-channel. Additional Directory Numbers are purchased separately.
- (10) Multi-line Hunt Group – This feature is limited to hunting within ISDN-BRI lines and on an individual customer location basis. Directory numbers within the multi-line hunt group may not have multiple call appearances.
- (11) Feature Package 1 - This package includes:
 - Calling Number ID/Calling Name ID
 - Call Forwarding
 - Flexible Calling
 - Automatic Callback
 - Additional Call Offering

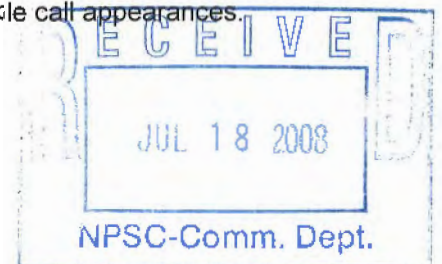

* ISDN terminal equipment is the responsibility of the customer and must support the configuration, optional services and features chosen by the customer.

⁽¹⁾ **Effective July 30, 2008, this service is no longer available to new residential customers. Existing customers may retain their current service at the same location until such service is changed or discontinued by the customer.**

(N)
|
(N)

UNITED TELEPHONE COMPANY OF THE WEST - NEBRASKA
GENERAL EXCHANGE
PRICE LIST

SECTION 1
PAGE: 5
RELEASE: 4

ISSUED: July 18, 2008

EFFECTIVE: July 30, 2008

INTEGRATED SERVICES DIGITAL NETWORK (ISDN)

I. BASIC RATE INTERFACE (BRI) ⁽¹⁾ (Cont'd) (C)

A. GENERAL (Cont'd)

5. Optional Services and Features* (Cont'd)

a. **Customers shall subscribe to one of the following ...** (Cont'd) (T)

(12) Loop Extension – ISDN-BRI is available only where the customer's service location is within the provisioning limitations as determined prior to installation of the service. This limitation is a cable plant distance of approximately 18,000 feet. The actual distance is dependent on decibel (db) loss and not just physical loop length. Should the customer's service location exceed said limitations, service will be provided where the Company has compatible facilities available, or where existing facilities can be made compatible by the addition of special equipment. This service, which carries an additional charge, is called Loop Extension and will extend the loop to approximately 36,000 feet.

B. REGULATIONS

1. This service is offered only where facilities and appropriate technology exist.
2. Local voice and data calls will be billed on a flat-rate basis, as shown in Section 1.I.C. of this tariff. Toll charges shall apply when data or voice calls are made outside of the customer's designated local calling area. When two simultaneous B-channels are combined for a maximum data speed of 128 Kbps, the toll call will be billed as if two calls were dialed by the originating customer.
3. In exchanges where IntraLATA Presubscription has been implemented, only one InterLATA and one IntraLATA Carrier may be selected for all B-channels associated with the same ISDN-BRI Service. Access via 101XXXX to other Interexchange Carriers is available.
4. A minimum service period of three months is required.
5. The Company shall terminate ISDN-BRI Services at the Company Network Interface Device (NID) located at the customer's premises.
6. Two Primary Directory Numbers will be included with an ISDN-BRI Service, one for each B-Channel. If Additional Directory Numbers are required on either channel, an additional charge, as specified in Section 1.I.D. of this tariff, will apply for each additional number.
7. ISDN-compatible customer premises terminal equipment is required for proper operation. It is the customer's responsibility to provide necessary power and obtain such equipment.

* ISDN terminal equipment is the responsibility of the customer and must support the configuration, optional services, and features chosen by the customer.

⁽¹⁾ **Effective July 30, 2008, this service is no longer available to new residential customers. Existing customers may retain their current service at the same location until such service is changed or discontinued by the customer.** (N)

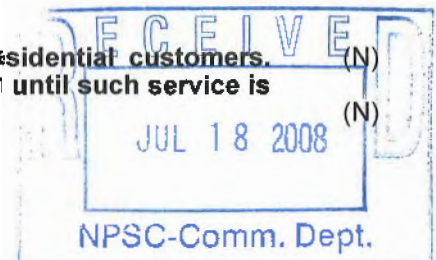

UNITED TELEPHONE COMPANY OF THE WEST - NEBRASKA d/b/a CENTURYLINK
GENERAL EXCHANGE
PRICE LIST

(C)

SECTION 1

PAGE: 6

RELEASE: 3

ISSUED: March 29, 2013

EFFECTIVE: April 8, 2013

INTEGRATED SERVICES DIGITAL NETWORK (ISDN)

I. BASIC RATE INTERFACE (BRI) ⁽¹⁾ (Cont'd)

B. REGULATIONS (Cont'd)

8. The provisions for temporary suspension of service, as defined in Section 20 of this tariff, do not apply to ISDN-BRI Service.
9. This service is available only from central offices, which have the necessary facilities to provide ISDN-BRI on the standard network platform. In the event a customer is provided service from a non-ISDN compatible central office, the Company will provide ISDN-BRI Service from an alternative serving central office. This provision is accomplished by utilizing a 'hubbing' architecture and the subscriber may be required to accept a unique NXX.

When a unique NXX is required, mileage charges for Foreign Exchange Service, specified in Section 25, will apply in addition to the rates and charges included in this section. Due to the nature of the 'hubbing' architecture and the use of a unique NXX, the local calling area (e.g., Extended Area Service) may change.

Emergency 911 calls placed over ISDN-BRI lines provisioned via this arrangement will be identified as the alternative service central office NXX and not the non-ISDN compatible central office NXX. The Company shall not be liable for any loss or damages arising from emergency calls placed from ISDN-BRI lines provisioned via an alternative serving central office.

10. One directory listing will be provided with ISDN-BRI. Additional listings are available as specified in the Company's General Exchange Tariff.
11. ISDN-BRI Service will be assessed the appropriate interstate charges (e.g. End User Common Line and Presubscribed Interexchange Carrier Charge), as defined in the **CenturyLink Operating Companies Tariff F.C.C. No. 9.**
12. ISDN-BRI does not provide for the transmission of packet data on either the D-channel or one of the B-channels.
13. ISDN-compatible terminal equipment is a requirement for operation and is the customer's responsibility. ISDN customer-premise equipment is dependent upon commercial power and not power from the Company central office. For their safety and well-being, all ISDN customers are encouraged to maintain a non-ISDN access line on the premises for emergency calls in the event of a loss of commercial electrical power. In the event a subscriber elects to disconnect or not maintain a non-ISDN access line, the customer assumes full responsibility for telephone service in the event of an emergency.
14. ISDN-BRI Service is available with single line residence⁽¹⁾ and business service.

⁽¹⁾ Effective July 30, 2008, this service is no longer available to new residential customers. Existing customers may retain their current service at the same location until such service is changed or discontinued by the customer.

UNITED TELEPHONE COMPANY OF THE WEST - NEBRASKA
GENERAL EXCHANGE
PRICE LIST

SECTION 1
PAGE: 7
RELEASE: 5
EFFECTIVE: June 26, 2009

ISSUED: June 16, 2009

INTEGRATED SERVICES DIGITAL NETWORK (ISDN)

I. BASIC RATE INTERFACE (BRI) ⁽¹⁾ (Cont'd)

B. REGULATIONS (Cont'd)

15. ISDN-BRI lines may be purchased out of this tariff to be associated with Centrex Service, as defined in Section 5 of the General Exchange Price List. Terms and conditions for Centrex Service will apply to these ISDN-BRI lines except as otherwise stated in this section. Optional features compatible with ISDN-BRI may be purchased from the Centrex Optional Features Section of the tariff as well as features unique to ISDN lines from the Optional Features in this section.

ISDN-BRI lines associated with Centrex Service may be purchased only for those features from the Centrex section of the tariff. ISDN-BRI can be provisioned in the same Centrex customer group if, and only if, the customer group is resident in an ISDN equipped host or remote office. All other Centrex customers can subscribe to ISDN-BRI, however, the service will be provisioned as a stand-alone service and will not be included in the customer group.

16. ISDN-BRI Service may be terminated in key telephone systems in lieu of a key trunk. However, the key telephone system must be ISDN compatible.
17. ISDN-BRI Service for customers subscribing to Rotary Hunt Service, as defined in Section 11 of the General Exchange Price List, will be provisioned outside the existing hunt group.
18. Verification and Emergency Interrupt service is not available for ISDN-BRI Service.

C. APPLICATION OF RATES

1. ISDN-BRI Service is offered on an unlimited use basis. All applicable state and federal charges will apply. Extended Area Service (EAS) charges, if applicable as defined in the Local Exchange Tariff apply per ISDN-BRI B-channel. Toll charges apply when data or voice calls are completed outside the customer's designated local calling area or EAS territory.
2. The monthly rates for Service Capability Packages are applied on a per package basis.
3. The ISDN-BRI monthly rates are in addition to the applicable R-1⁽¹⁾ (**Residence Individual Line**), B-1 (**Business Individual Line**) or Centrex access line rate. These rates vary by service area and can be found in the Local Exchange Tariff and Section 5 of the General Exchange Price List Tariff. (T)
(T)

⁽¹⁾ Effective July 30, 2008, this service is no longer available to new residential customers. Existing customers may retain their current service at the same location until such service is changed or discontinued by the customer. June 26, 2009

UNITED TELEPHONE COMPANY OF THE WEST – NEBRASKA d/b/a CENTURYLINK
GENERAL EXCHANGE
PRICE LIST

(C)

SECTION 1

PAGE: 8

RELEASE: 3

ISSUED: July 9, 2015

EFFECTIVE: July 20, 2015

INTEGRATED SERVICES DIGITAL NETWORK (ISDN)

I. BASIC RATE INTERFACE (BRI) ⁽¹⁾ (Cont'd)

C. APPLICATION OF RATES (Cont'd)

4. The Non-Recurring Charge for ISDN Service Capability Package installation will be discounted 50% when a customer commits to a 12-month service period or 100% when a customer commits to a 24-month service period. If termination of service prior to the end of the commitment occurs, the customer is responsible for payment of the discounted amount of the Non-Recurring Charge which represents the installation charges initially waived.

(a) However, this termination requirement will not apply when the customer converts to a next generation service offering of a separately tariffed service, provided that:

- (1) The service period for the new service offering is a minimum period equal to or exceeding the remaining service period of the disconnected arrangement, whichever is greater; and
- (2) The service orders to install the new service and disconnect the old service are related together, and there is no lapse in service between installation of the new service and disconnection of the existing service; and
- (3) The service orders are for the same customer at the same location.

Integrated Services Digital Network-Basic Rate Interface (ISDN-BRI) to:
Integrated Services Digital Network-Primary Rate Interface (ISDN-PRI) is
an example of a next generation service offering.

(T)
(D)

5. ISDN-BRI provides for one Configuration Group to be established at the initial implementation of service. Subsequent additions of Configuration Groups or in excess of one group on the initial establishment of service will be charged an installation charge per Configuration Group.
6. A Change Charge will apply for a database change subsequent to the installation of an ISDN-BRI Service. This includes changing, adding, or deleting features or feature packages, directory numbers or number appearances.

⁽¹⁾ Effective July 30, 2008, this service is no longer available to new residential customers. Existing customers may retain their current service at the same location until such service is changed or discontinued by the customer.

NE 15-07

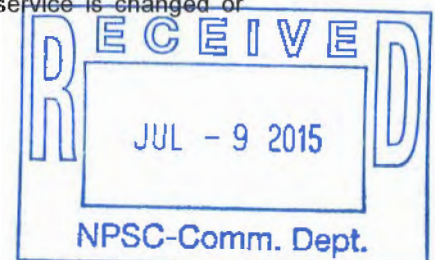

UNITED TELEPHONE COMPANY OF THE WEST - NEBRASKA
GENERAL EXCHANGE
PRICE LIST

SECTION 1
PAGE: 9
RELEASE: 4
EFFECTIVE: June 26, 2009

ISSUED: June 16, 2009

INTEGRATED SERVICES DIGITAL NETWORK (ISDN)

I. BASIC RATE INTERFACE (BRI) ⁽¹⁾ (Cont'd)

D. RATES AND CHARGES

1. SERVICE CAPABILITY PACKAGES	<u>S&E Codes</u>	<u>Monthly Rate</u>	<u>NRC</u>
Standard ISDN-BRI Package (Package S without features)	1FLCBRC(Res) 1FLCBRC(Bus) 1FLCBRI	\$25.00 \$35.00	\$200.00 \$200.00
Package H (Key Telephone System)	1FLCBRC 1FLCBRI	\$35.00	\$200.00
Package L (Key Telephone System)	1FLCBRC 1FLCBRI	\$35.00	\$200.00
Loop Extension	MCSXNDC MCSXNDD	\$20.00	N/A
2. OPTIONAL FEATURES	<u>S&E Codes</u>	<u>Monthly Rate</u>	
Calling Number ID/Calling Name ID	FCVISBC, FCVISBR	\$7.00	
Call Pickup (per member)	FCUISBC, FCUISBR	\$2.00	
Flexible Calling	FFXISBC, FFXISBR	\$3.00	
Six-Way Conference Calling	FSXISBC, FSXISBR	\$5.00	
Automatic Callback (Repeat Dial)	FTBISBC, FTBISBR	\$2.00	
Additional Call Offering (ACO)	FEAISBC, FEAISBR	\$4.00	
Call Forwarding	FCFISBC, FCFISBR	\$3.00	
Additional Directory Number (each)	FNSISBC, FNSISBR	\$2.00	
Multi-line Hunt Group	FSHISBC, FSHISBR	\$2.00	
3. FEATURE PACKAGE 1:	FPKISBC, FPKISBR		\$12.00
Calling Number ID/Calling Name ID			
Call Forwarding			
Flexible Calling			
Automatic Callback			
Additional Call Offering			
4. CHANGE CHARGES	<u>Non-Recurring Charge</u>		
Closed User Group	\$35.00		
Configuration Group	\$65.00		
Database Change	\$15.00		

JUN 16 2009

* The ISDN-BRI rates set forth above are in addition to an applicable R-1⁽¹⁾ (**Residence Individual Line**), B-1 (**Business Individual Line**) or Centrex access line rates. (T)
(T)

⁽¹⁾ Effective July 30, 2008, this service is no longer available to new residential customers. Existing customers may retain their current service at the same location until such service is changed or discontinued by the customer.

UNITED TELEPHONE COMPANY OF THE WEST d/b/a CENTURYLINK
GENERAL EXCHANGE
PRICE LIST

SECTION 1
PAGE: 10
RELEASE: 5

ISSUED: November 30, 2018

EFFECTIVE: December 10, 2018

INTEGRATED SERVICES DIGITAL NETWORK (ISDN)

II. PRIMARY RATE INTERFACE (PRI)

Effective January 10, 2013, this service is limited to existing facilities in service at existing locations for current customers. Current customers may migrate existing services to Integrated Services Digital Network-Primary Rate Interface (ISDN-PRI) Business Service in Section 1.III of this Price List at any time without incurring any Nonrecurring Charges or Service Charges. TDP customers may migrate existing services without incurring termination liability charges when they select a commitment period equal to or greater than the length of time remaining under their existing TDP.

A. General

1. Integrated Services Digital Network - Primary Rate Interface (ISDN-PRI) Service is a local exchange offering supported by the ISDN architecture.
2. ISDN-PRI Service provides a method of access to the telephone network called Primary Rate Access. Primary Rate Access is an ISDN based, DS1 access link to the telecommunications network and provides integration of multiple voice and data transmission channels on the same line. The service provides connectivity between an ISDN-PBX or other ISDN-compatible CPE and a serving central office. The basic channel structure for Primary Rate Access is twenty-three 64 Kbps B-Channels and one 64 Kbps D-Channel. After purchasing the original 23 B-Channel plus one D-Channel configuration, the customer may purchase another Primary Rate Access Line and another Primary Rate Interface as well as additional B-Channels in increments of 12.

These channels may be used to connect the customer's CPE to the Public Network (i.e., outward, inward, and two-way **trunks**).

(D)

3. ISDN-PRI Service provides network communication paths providing the end user with access to a variety of network services and features including data, voice and video which conforms to internationally developed, published, and recognized standards generated by the International Telecommunications Union (ITU).
4. Unless specified, the regulations for ISDN-PRI Service apply in addition to the General Regulations set forth in the General Exchange Tariff.
5. ISDN-PRI Service and its optional features and functions are provided within a LATA from central offices where appropriate ISDN facilities are available as determined by the Company. Service inquiries will be necessary to determine availability. Construction and Installation Charges may apply as specified in Section 3 of the General Exchange Tariff.

UNITED TELEPHONE COMPANY OF THE WEST d/b/a CENTURYLINK
GENERAL EXCHANGE
PRICE LIST

SECTION 1
PAGE: 11
RELEASE: 5

ISSUED: November 30, 2018

EFFECTIVE: December 10, 2018

INTEGRATED SERVICES DIGITAL NETWORK (ISDN)

II. PRIMARY RATE INTERFACE (PRI) ⁽¹⁾ (Cont'd)

B. Terms and Conditions

1. Customer Premises Equipment (CPE) that is compatible with ISDN-PRI Service is the customer's responsibility to provision.
2. The Company shall not be responsible if changes in any of the equipment, operations or procedures of the Company utilized in the provisioning of ISDN-PRI Service render any facilities provided by the customer obsolete or require modification or alteration of such equipment or system or otherwise affect its use or performance.
3. Digital transmission rates at speeds less than those indicated may be accomplished as a function of the particular CPE furnished by the user.
4. Suspension of service at request of subscribers, as defined in Section 20 of the General Exchange Tariff, does not apply to ISDN-PRI Service.
5. Service Charges specified in Section 18 of the General Exchange Tariff apply to any charges not specified in this section.
6. The minimum service period for ISDN-PRI Service is six months.
7. The customer is responsible for payment of a Maintenance of Service Charge, as set forth in Section 11 of the Price List, for visits by the Company to the customer's premises when a service difficulty resulting in a trouble report is caused by the use of equipment or facilities provided by the customer.
8. Telephone numbers transmitted via the Optional or Standard Incoming Call Identification feature are intended solely for the use of the ISDN-PRI Service subscriber. Resale of this call identification information is prohibited by this price list.
9. **Reserved**
10. Non-Facility Associated Signaling (NFAS) provides the capability to serve multiple DS1's via a single D-Channel. This feature can be ordered where switch capabilities exist as determined by the Company. When NFAS is selected, the customer will order one ISDN-PRI Service arrangement with 23 B-Channels and 1 D-Channel. Additional ISDN-PRI Services arrangements are ordered with 24 B-Channels as specified in Section 1.II.F. of the Price List. The D-Channel activated on the initial arrangement serves the additional ISDN-PRI arrangements.

(D)
(D)

⁽¹⁾ Effective January 10, 2013, this service is limited to existing facilities in service at existing locations for current customers.

UNITED TELEPHONE COMPANY OF THE WEST - NEBRASKA d/b/a CENTURYLINK
GENERAL EXCHANGE
PRICE LIST

SECTION 1
PAGE: 12
RELEASE: 3
EFFECTIVE: 01-10-13

ISSUED: 12-28-12

INTEGRATED SERVICES DIGITAL NETWORK (ISDN)

II. PRIMARY RATE INTERFACE (PRI) ⁽¹⁾ (Cont'd) (C)

B. Terms and Conditions (Cont'd)

10. Non-Facility Associated Signaling (NFAS) provides the capability ... (Cont'd) (M)

After the first 23B + D PRI is purchased, a customer can purchase additional B-Channels in increments of 12. Additional Primary Rate Access Lines may be ordered in a 24B configuration. However, the Company recommends that the quantity of Primary Rate Access Lines supported by one (1) D-Channel not exceed four (4). The Company recommends the use of a backup D-Channel for the support of signaling beyond four (4) facilities. (M)

11. This service is available only from central offices, which have the necessary facilities to provide ISDN-PRI on the standard network platform. In the event a customer is provided service from a non-ISDN compatible central office, the Company will provide ISDN-PRI Service from an alternative serving central office, as designated by the Company. This provision is accomplished by utilizing a 'hubbing' architecture and the subscriber may be required to accept a foreign NXX. When a foreign NXX is required, mileage charges applicable to High Capacity Service, as defined in the Company's Access Service Tariff, apply in addition to the rates and charges included in this section. Due to the nature of the 'hubbing' architecture and the use of a foreign NXX, the local calling area (e.g., Extended Area Service) may change.

When ISDN functionality becomes available from the central office that normally serves this subscriber, ISDN-PRI Service will be provided from that office and the subscriber may be required to accept a different NXX. If the subscriber chooses to continue ISDN-PRI Service from the alternative serving central office, all charges applicable to High Capacity Service, as defined in the Company's Access Service Tariff, will apply in addition to the rates and charges included in this section.

Similarly, if a subscriber requests ISDN-PRI Service from an alternative serving central office other than that designated by the Company, all charges applicable to High Capacity Service, as defined in the Company's Access Service Tariff, will apply in addition to the rates and charges included in this section.

Emergency 911 calls placed over ISDN-PRI Primary Rate Access Lines provisioned via this arrangement will be identified as the alternative serving central office NXX and not the non-ISDN compatible central office NXX. The Company shall not be liable for any loss or damages arising from the emergency calls placed from ISDN-PRI Primary Rate Access Lines provisioned via an alternative serving central office.

⁽¹⁾ **Effective January 10, 2013, this service is limited to existing facilities in service at existing locations for current customers.** (N)
(N)

(M) Material now appearing on this page was previously found on Page 11, Release 303 3 1 2012

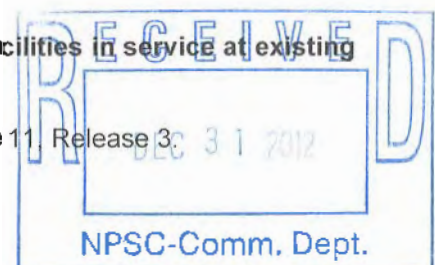

UNITED TELEPHONE COMPANY OF THE WEST - NEBRASKA d/b/a CENTURYLINK
GENERAL EXCHANGE
PRICE LIST

SECTION 1
PAGE: 13
RELEASE: 5
EFFECTIVE: 01-10-13

ISSUED: 12-28-12

INTEGRATED SERVICES DIGITAL NETWORK (ISDN)

II. PRIMARY RATE INTERFACE (PRI) ⁽¹⁾ (Cont'd)

(C)

B. Terms and Conditions (Cont'd)

12. This service is available only where the customer's service location is within the provisioning limitations as determined prior to installation of the service. Should the customer's service location exceed said limitations, service will be provided where the Company has electronically compatible facilities available, or where existing facilities can be made electronically compatible.
13. Rotary Hunt Service is available, at no additional charge, exclusively within the B-channels of a single ISDN-PRI service arrangement or between multiple ISDN-PRI service arrangements. Rotary Hunt Service is not allowed between ISDN-PRI service arrangements and other services, including but not limited to Business Individual Line Service and High Capacity Service.
14. ISDN-PRI Service is not offered in conjunction with Local Measured Service or Extended Area Service.
15. In order to maintain the quality of ISDN-PRI Service, the Company reserves the right to perform preventative maintenance and software updates to the network. The Company has classified this maintenance as indicated below:

Scheduled Maintenance

Scheduled maintenance is used to perform such functions as hardware and software upgrades and network optimization. The Company will perform these tasks in a maintenance window that is anticipated to minimize disruption of customer service and activity. The Company will provide advance notice of all scheduled maintenance.

Demand Maintenance

Demand Maintenance may occur as a result of unexpected events and is used when ISDN-PRI network elements are in jeopardy. The Company will perform this type of maintenance at its discretion. Due to the nature of demand maintenance prior notification may not be possible, however, the customer will be informed when the maintenance has been completed.

16. One Directory Listing will be provided per D-Channel. Additional Directory Listings are available as specified in Section 4 of the General Exchange Tariff.

C. DEFINITIONS

B-Channel – A bi-directional synchronous channel capable of supporting 64 Kbps of digital transmission.

D-Channel – A 64 Kbps digital signaling only channel for call establishment when used with Primary Rate Access.

⁽¹⁾ **Effective January 10, 2013, this service is limited to existing facilities in service at existing locations for current customers.**

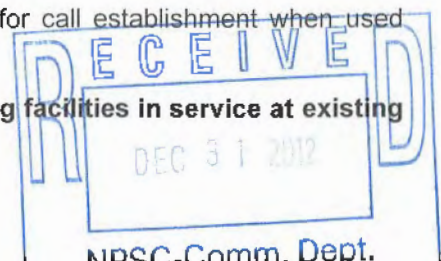

(N)
(N)

UNITED TELEPHONE COMPANY OF THE WEST - NEBRASKA d/b/a CENTURYLINK
GENERAL EXCHANGE
PRICE LIST

SECTION 1
PAGE: 14
RELEASE: 3
EFFECTIVE: 01-10-13

ISSUED: 12-28-12

INTEGRATED SERVICES DIGITAL NETWORK (ISDN)

II. PRIMARY RATE INTERFACE (PRI) ⁽¹⁾ (Cont'd)

(C)

D. Features

1. Standard Features

Dynamic Allocation of Bandwidth

Allows the voice and data services to share B-Channels and arrange them as a single trunk group. This allows incoming and outgoing voice and data calls to utilize B-Channels on a call by call basis. Without this capability, each service will have a dedicated B-Channel.

Incoming Call Identification (Caller ID)

Provides the customer with the telephone number of the calling party. Incoming call identification is provided via the D-Channel associated with the incoming calls on a B-Channel to a PBX.

Clear Channel Capability

The B-Channels on ISDN-PRI are clear, since all signaling and control functions are handled by the D-Channel. This allows all 64 Kbps on each B-Channel to be used for customer information.

D-Channel Control of Multiple ISDN Lines

Provides capability for a single D-Channel to provide signaling and control for one or more ISDN-PRI connections. After the original 23 B-Channel plus one D-Channel, the 24th channel on subsequent ISDN-PRI lines is then made available for customer use. The Company recommends the purchase of a backup D-Channel after the fourth ISDN-PRI line is purchased.

Digital Voice Transmission

All voice calls are transmitted using digital signaling.

Direct Inward Dialing (DID) Signaling

Permits incoming dialed calls from the exchange network to reach a specific number served by customer premises equipment (CPE) without the assistance of an attendant. It also provides for the unique identification of the call based on digits sent to the CPE by the central office. The central office will output digits to the CPE that can further process the calls as desired. The rates and charges for DID telephone numbers are in addition to the ISDN-PRI charges and are provided in Section 11 of the Price List.

⁽¹⁾ **Effective January 10, 2013, this service is limited to existing facilities in service at existing locations for current customers.**

(N)
(N)

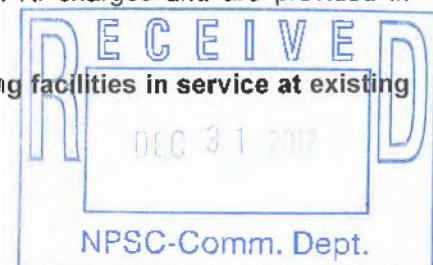

UNITED TELEPHONE COMPANY OF THE WEST d/b/a CENTURYLINK
GENERAL EXCHANGE
PRICE LIST

SECTION 1
PAGE: 15
RELEASE: 4

ISSUED: November 30, 2018

EFFECTIVE: December 10, 2018

INTEGRATED SERVICES DIGITAL NETWORK (ISDN)

II. PRIMARY RATE INTERFACE (PRI) ⁽¹⁾ (Cont'd)

D. Features (Cont'd)

1. Standard Features (Cont'd)

PBX Station ID Capability

Allows the station users number (calling party) to be transmitted over the ISDN-PRI D-Channel from Direct Inward Dialing equipped CPE PBXs that use ISDN-PRI. This number is provided by the originating station and must have an associated Direct Inward Dialing telephone number working in the central office.

2. Optional Features

D-Channel Backup

Provides backup for the D-Channel for a customer with multiple PRI lines by automatically switching signaling capability over to another D-Channel if service to the primary D-Channel is interrupted.

Network Ring Again

Enables the customer to complete calls to a busy station without continually redialing. Certain equipment restrictions may apply.

Call-by-Call/Integrated Service Access Feature Capability

Allows the customer to dynamically allocate the use of channels for ISDN-PRI Service. The customer may also choose voice or data transmission on a per call basis. In addition, the customer may also choose to subscribe to more services than channels. The Customer Premises Equipment signals the local central office as to which type of service (inward/outward **trunk**) to access for each call.

(D)

Incoming Call Identification (Caller ID Name and Number)

Provides the customer with the telephone number and name of the calling party. Incoming call identification is provided via the D-Channel associated with incoming calls on a B-Channel to a PBX. The Customer's equipment must be compatible with this service.

⁽¹⁾ Effective January 10, 2013, this service is limited to existing facilities in service at existing locations for current customers.

UNITED TELEPHONE COMPANY OF THE WEST - NEBRASKA d/b/a CENTURYLINK
GENERAL EXCHANGE
PRICE LIST

SECTION 1
PAGE: 15.1
RELEASE: 2
EFFECTIVE: 01-10-13

ISSUED: 12-28-12

INTEGRATED SERVICES DIGITAL NETWORK (ISDN)

II. PRIMARY RATE INTERFACE (PRI) ⁽¹⁾ (Cont'd)

(C)

D. Features (Cont'd)

2. Optional Features (Cont'd)

2 B-Channel Transfer

If a call terminates at a given location, but is then forwarded to another location, two trunks between the Central Office and the original device are typically employed for the duration of the forwarded call. 2 B-Channel Transfer allows the central office switch to establish the call directly to the final destination and release the trunks going in and out of the forwarding device. This saves the customer PRI facilities and provides for more efficient use of the network. A common use of 2 B-Channel Transfer is illustrated below.

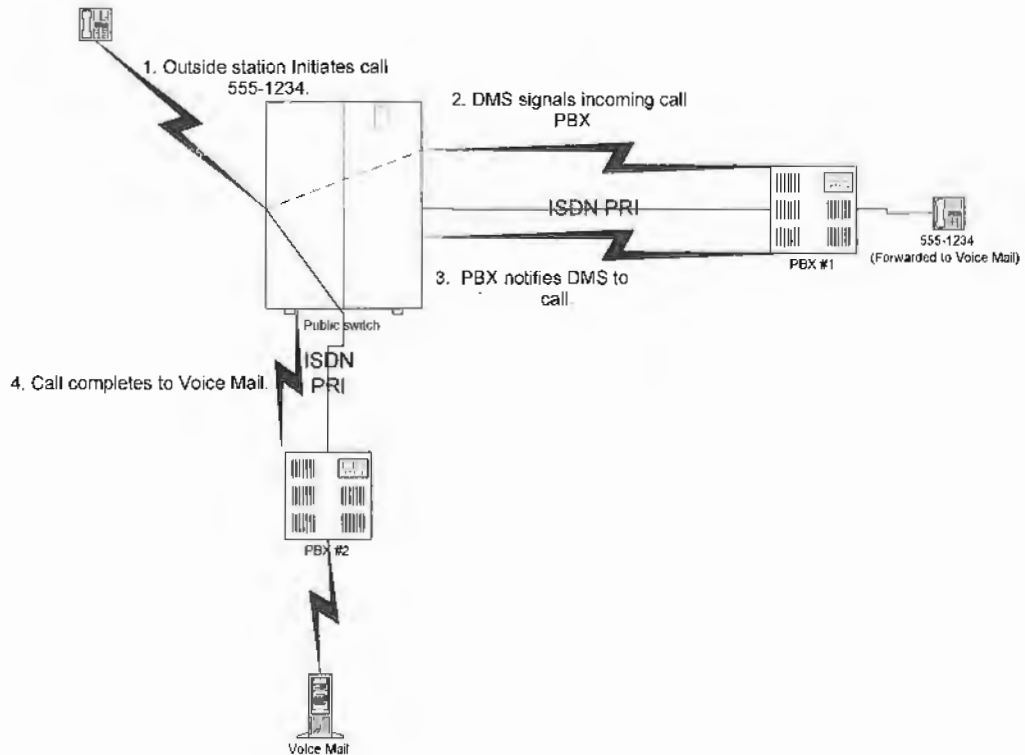

⁽¹⁾ Effective January 10, 2013, this service is limited to existing facilities in service at existing locations for current customers.

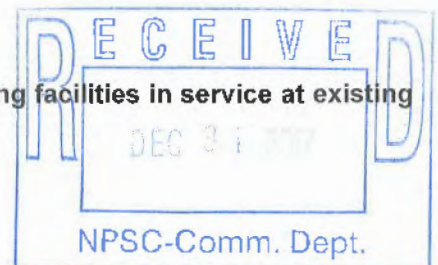

(N)
(N)

UNITED TELEPHONE COMPANY OF THE WEST - NEBRASKA d/b/a CENTURYLINK
GENERAL EXCHANGE
PRICE LIST

SECTION 1
PAGE: 15.2
RELEASE: 2
EFFECTIVE: 01-10-13

ISSUED: 12-28-12

INTEGRATED SERVICES DIGITAL NETWORK (ISDN)

II. PRIMARY RATE INTERFACE (PRI) ⁽¹⁾ (Cont'd)

(C)

D. Features (Cont'd)

2. Optional Features (Cont'd)

Circular Hunt

Circular Hunt provides the most efficient hunting sequence available, plus allows for much larger trunk groups than the standard ISDN-PRI packages. With circular hunt, an incoming call is completed to the next available trunk (bearer) in sequence starting from the last trunk selected. This can occur across multiple PRI facilities. The feature can support up to 220 Primary Rate Interfaces in a single hunting configuration. The standard limit is 50.

National ISDN-2 Protocol

National ISDN-2 Protocol is a communication protocol that governs interactions between the customer's equipment and the telephone network. This protocol is more advanced than the standard ISDN-PRI protocol. Most CPE is capable of using the ISDN-2 Protocol.

E911 Call Screening

E911 Call Screening provides for the transmission of PBX or Key System station information via the ISDN-PRI facility to local emergency services authorities. This provides for the possible identification of the specific location on a customer's premises where a 911 call originated. This option is available only in communities where local emergency authorities support the service in conjunction with the Company's Private Switch Automatic Location Identification (PSALI) Service, associated with E911 Service. This service is only available in conjunction with National ISDN-2 Protocol.

⁽¹⁾ **Effective January 10, 2013, this service is limited to existing facilities in service at existing locations for current customers.**

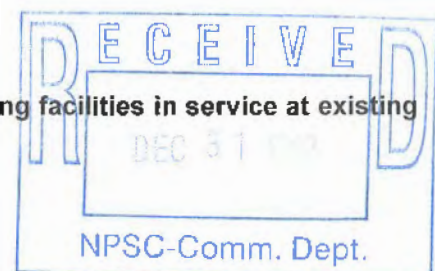

(N)
(N)

UNITED TELEPHONE COMPANY OF THE WEST d/b/a CENTURYLINK
GENERAL EXCHANGE
PRICE LIST

SECTION 1
PAGE: 16
RELEASE: 5

ISSUED: November 30, 2018

EFFECTIVE: December 10, 2018

INTEGRATED SERVICES DIGITAL NETWORK (ISDN)

II. PRIMARY RATE INTERFACE (PRI) ⁽¹⁾ (Cont'd)

E. Service Components

1. The components for ISDN-PRI Service will be as follows:

- Primary Rate Access Line
- Primary Rate Interface
- Primary Rate Channels

(a) Primary Rate Access Line - Will provide a four-wire access loop from the customer premises to the serving central office. The transmission via this loop supports Clear Channel Capability.

(b) Primary Rate Interface - Provides the multiplexing to support up to twenty-three (23) B-Channels at 64 Kbps and one (1) D-Channel for signaling also at 64 Kbps. When NFAS is ordered, the Primary Rate Interface can provide up to twenty-four B-Channels at 64 Kbps.

(c) Primary Rate Channels - Will provide unlimited usage of channel that will allow either voice or data transmission up to 64 Kbps.

(1) Voice calls may be completed to both ISDN and non-ISDN lines.

(2) Data Transmission on the B-Channels will be at 64 Kbps within the switch and between ISDN compatible central offices. ISDN interconnection to non-ISDN equipped central offices may be potentially subjected to analog transmission or sub-rated to 56 Kbps.

2. With the first ISDN-PRI Primary Rate Access Line the customer is required to purchase 23 B-Channels and an initial D-Channel.

After the initial 23B + D configuration, the customer may choose channels in increments of 12 up to twenty-three B + D or twenty-four B with NFAS, per ISDN-PRI Primary Rate Access Line (facility) to be active with a corresponding number of services (i.e., inward/outward **trunks**) selected. The customer may also choose to subscribe to more services than channels. The Customer Premises Equipment signals the local central office as to which type of service (inward/outward **trunk**) to access for each call.

⁽¹⁾ Effective January 10, 2013, this service is limited to existing facilities in service at existing locations for current customers.

UNITED TELEPHONE COMPANY OF THE WEST - NEBRASKA d/b/a CENTURYLINK
 GENERAL EXCHANGE
 PRICE LIST

SECTION 1
 PAGE: 17
 RELEASE: 3
 EFFECTIVE: 01-10-13

ISSUED: 12-28-12

INTEGRATED SERVICES DIGITAL NETWORK (ISDN)

II. PRIMARY RATE INTERFACE (PRI) ⁽¹⁾ (Cont'd) (C)

F. Application of Rates

1. ISDN-PRI Primary Rate Access Lines furnished between a serving central office and the customer-designated premises will be charged at rates per each Primary Rate Access Line.
2. Nonrecurring charges will not be applicable for the Primary Rate Access Line or interoffice channel facilities when upgrading an existing High Capacity Service to an ISDN-PRI Service.
3. ISDN-PRI Primary Rate Access Line rates, including interoffice channels if applicable, apply in addition to Primary Rate Interface and Primary Rate Channel charges.
4. If the customer chooses to purchase additional channels after purchasing the original 23B + D configuration, the customer must purchase another Primary Rate Access Line and another Primary Rate Interface as well as the additional channels. Additional channels can be purchased in increments of 12.

G. Rates and Charges

1. ISDN-PRI Primary Rate Access Line

Primary Rate Access Line is furnished between a serving central office and the customer's designated premises. Primary Rate Access Line charges apply per point of termination.

(a) Primary Rate Access Line (Intraexchange)

	Monthly Rate	Nonrecurring Charge First	Nonrecurring Charge Add'l ⁽²⁾	(T)
1.544 Mbps				
Month to month ⁽³⁾	\$325.00	\$265.00	\$110.00	(T)
12-23 months	\$275.00	\$165.00	\$110.00	
24-35 months	\$250.00	\$110.00	\$110.00	
36-59 months	\$225.00	N/A	N/A	
60-84 months	\$200.00	N/A	N/A	

⁽¹⁾ **Effective January 10, 2013, this service is limited to existing facilities in service at existing locations for current customers.** (N)
 (N)

⁽²⁾ Additional facilities must be installed at the same customer designated premises on the same trip and placed on the same service order. (T)

⁽³⁾ Minimum Service Period for ISDN-PRI is six months. (T)

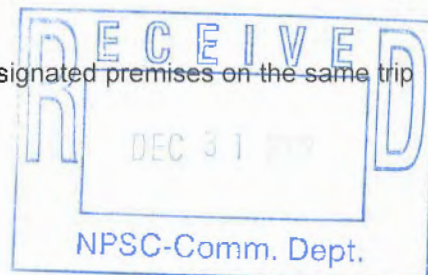

UNITED TELEPHONE COMPANY OF THE WEST - NEBRASKA d/b/a CENTURYLINK
 GENERAL EXCHANGE
 PRICE LIST

SECTION 1
 PAGE: 18
 RELEASE: 3
 EFFECTIVE: 01-10-13

ISSUED: 12-28-12

INTEGRATED SERVICES DIGITAL NETWORK (ISDN)

II. PRIMARY RATE INTERFACE (PRI) ⁽¹⁾ (Cont'd)

(C)

G. Rates and Charges (Cont'd)

1. ISDN-PRI Primary Rate Access Line (Cont'd)

(b) Primary Rate Access Line (Interexchange)

The rates, charges and regulations applicable to High Capacity Service, as defined in the Company's Access Service Tariff, also apply for interexchange Primary Rate Access Lines.

2. Primary Rate Interface	<u>Monthly Rate</u>	<u>Nonrecurring Charge</u>
(a) Primary Rate Interface One-Way Per ISDN-PRI Primary Rate Access Line (Data only or Voice and Data)		
Month to month	\$269.00	\$265.00
12-23 months	\$253.00	\$165.00
24-35 months	\$241.00	\$ 20.00
36-59 months	\$230.00	N/A
60-84 months	\$224.00	N/A
(b) Primary Rate Interface Two-Way Per ISDN-PRI Primary Rate Access Line		
Month to month	\$419.00	\$265.00
12-23 months	\$403.00	\$165.00
24-35 months	\$381.00	\$ 20.00
36-59 months	\$360.00	N/A
60-84 months	\$349.00	N/A
3. ISDN-PRI Services will be available in combinations of Primary Rate Channels according to the limits of the Company central office type. Customers will choose the most appropriate combination(s) and will be billed for the services as appropriate. The initial configuration must be 23 B-Channels and 1 D-Channel. Additional configurations are outlined in Section 1.II.E.2. of the Price List.		
(a) B-Channel Charge, each channel		
Month to month	\$19.00	\$5.00
12-23 months	\$18.00	\$5.00
24-35 months	\$16.00	\$5.00
36-59 months	\$15.00	N/A
60-84 months	\$14.00	N/A

⁽¹⁾ **Effective January 10, 2013, this service is limited to existing facilities in service at existing locations for current customers.**

(N)
 (N)

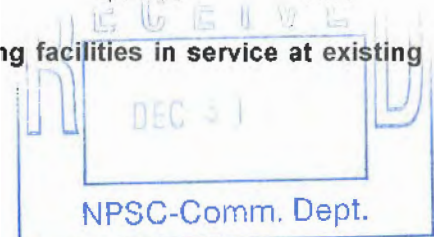

UNITED TELEPHONE COMPANY OF THE WEST - NEBRASKA d/b/a CENTURYLINK
 GENERAL EXCHANGE
 PRICE LIST

SECTION 1
 PAGE: 19
 RELEASE: 4
 EFFECTIVE: 01-10-13

ISSUED: 12-28-12

INTEGRATED SERVICES DIGITAL NETWORK (ISDN)

ii. PRIMARY RATE INTERFACE (PRI) ⁽¹⁾ (Cont'd) (C)

G. Rates and Charges (Cont'd)

3. ISDN-PRI Services will be available ... (Cont'd)

	<u>Monthly Rate</u>	<u>Nonrecurring Charge</u>
(b) Initial D-Channel		
Month to month	\$19.00	\$5.00
12-23 months	\$18.00	\$5.00
24-35 months	\$16.00	\$5.00
36-59 months	\$15.00	N/A
60-84 months	\$14.00	N/A

4. Optional Features **specified in Section 1.II.D.2 preceding and Optional Feature Packages are charged at the rates specified in Section 1.III.G. 2. and 3.** (T)
 (T)

(M)

(M)

⁽¹⁾ **Effective January 10, 2013, this service is limited to existing facilities in service at existing locations for current customers.** (N)
 (N)

⁽²⁾ Available only to customers subscribing to more than one Primary Rate Interface. (T)

⁽³⁾ Certain equipment restrictions apply. (T)

(M) Material previously appearing on this page now appears on Page 34, Release 10-31-2012

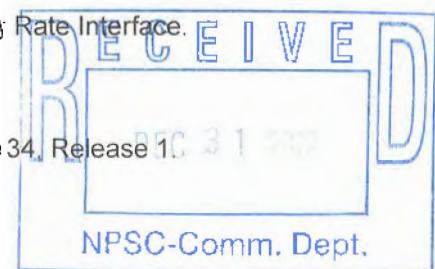

UNITED TELEPHONE COMPANY OF THE WEST - NEBRASKA d/b/a CENTURYLINK
GENERAL EXCHANGE
PRICE LIST

SECTION 1
PAGE: 19.1
RELEASE: 4
EFFECTIVE: 01-10-13

ISSUED: 12-28-12

INTEGRATED SERVICES DIGITAL NETWORK (ISDN)

II. PRIMARY RATE INTERFACE (PRI) ⁽¹⁾ (Cont'd) (C)

G. Rates and Charges (Cont'd) (M)

5. Move Charge (M)

A Move Charge, per ISDN-PRI Primary Rate Access Line, applies for each Primary Rate Access Line moved to a new location in the same building. This Move Charge is equal to the sum of the Primary Rate Access Line nonrecurring charge, Service Change Charge - Inside Moves and Premises Visit Charge specified in Section 1.II.G.7.(d). of the Price List.

⁽¹⁾ **Effective January 10, 2013, this service is limited to existing facilities in service at existing locations for current customers.** (N)

(M) Material previously appearing on this page now appears on Page 34, Release 1 and Page 35, Release 1. (N)

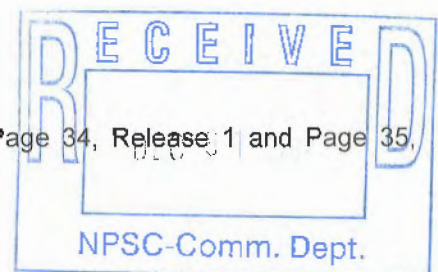

UNITED TELEPHONE COMPANY OF THE WEST - NEBRASKA d/b/a CENTURYLINK
 GENERAL EXCHANGE
 PRICE LIST

SECTION 1
 PAGE: 20
 RELEASE: 3
 EFFECTIVE: 01-10-13

ISSUED: 12-28-12

INTEGRATED SERVICES DIGITAL NETWORK (ISDN)

II. PRIMARY RATE INTERFACE (PRI) ⁽¹⁾ (Cont'd) (C)

G. Rates and Charges (Cont'd)

6. Service Connection Charges (T)

- (a) Service Establishment Charges are applicable for each ISDN-PRI Primary Rate Access Line ordered, for receiving and recording information and/or taking action in connection with a customer's request, and processing the necessary data. These charges include engineering design, common centralized testing and coordination. The nonrecurring charges associated with service establishment are found in Section 1.II.G.1,2 and 3. of the Price List.
- (b) Service Change Charges are applicable for receiving and recording information and/or taking action in connection with a customer's termination change at the same premises or transfer of service responsibility request, for processing the necessary data on an existing Primary Rate Access Line. A Service Change Charge is applicable for each Primary Rate Access Line associated with the customer request (in lieu of a Service Establishment Charge).
- (c) Premises Visit Charges are applicable per Primary Rate Access Line, for the termination of a channel at a customer's premises or for termination change at the same premises. Only one Premises Visit Charge applies when more than one channel service of the same type is terminated or moved at the same premises at the same time.
- (d) Charges

	<u>Nonrecurring Charges</u>
(1) Service Change Charge per Primary Rate Access Line	
(i) For termination change at the same premises, physical, per PRI interface	\$165.00
(ii) For termination change at the same premises, programming, per PRI interface	\$ 35.00
(2) Premises Visit Charge per Primary Rate Access Line or for an inside move	\$125.00

⁽¹⁾ Effective January 10, 2013, this service is limited to existing facilities in service at existing locations for current customers. (N)
 (N)

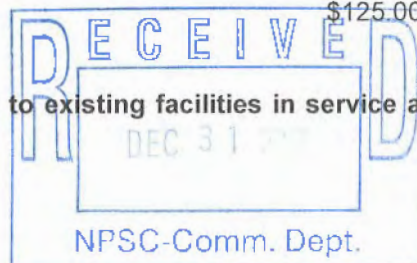

UNITED TELEPHONE COMPANY OF THE WEST - NEBRASKA d/b/a CENTURYLINK
GENERAL EXCHANGE
PRICE LIST

SECTION 1
PAGE: 21
RELEASE: 7
EFFECTIVE: 01-10-13

ISSUED: 12-28-12

INTEGRATED SERVICES DIGITAL NETWORK (ISDN)

II. PRIMARY RATE INTERFACE (PRI) ⁽¹⁾ (Cont'd) (C)

G. Rates and Charges (Cont'd)

7. Termination Liability Charges (T)

- (a) If a customer under a Term Discount Plan (TDP) disconnects all or a portion of ISDN PRI Service prior to the expiration of the TDP, then a Termination Liability Charge will apply to those services that are disconnected. The Termination Liability Charge will be a one-time charge equal to sum of 50% of the payments remaining for the rest of the TDP. If Charges Applicable Under Special Conditions were applied to the service being terminated, any termination charges associated with Charges Applicable Under Special Conditions will also apply.
- (b) Rate increases or decreases will automatically be applied to the monthly term plan rates for the remaining term of the TDP. If a Telephone Company initiated rate increase to any rate element or combination of rate elements causes the charges for the entire ISDN PRI Service under the TDP to increase by 10% or more annually, then the customer may cancel the TDP without incurring termination liability charges provided the customer notifies the Telephone Company within 30 days after the effective date of the rate increase.
- (c) The customer can extend TDP commitment periods at any time during the term of the plan, up to a maximum of 84 months. The number of months accrued in the current plan will apply toward the new plan selected.
- (d) At the end of the TDP service commitment period, the customer may subscribe to a new TDP at the prevailing rates. If the customer does not select a new TDP, the prevailing rates applicable for the expired TDP will continue in effect for as long as the customer chooses to continue subscribing to the ISDN-PRI services installed under the expired TDP. Additional ISDN-PRI services installed after the TDP expiration date will not be eligible for the TDP rates and will be charged at the prevailing month to month rates unless the customer selects a TDP for those services.

(M)

(M)

⁽¹⁾ **Effective January 10, 2013, this service is limited to existing facilities in service at existing locations for current customers.** (N)
(N)

(M) Material previous appearing on this page is now found on Page 22, Release 1.

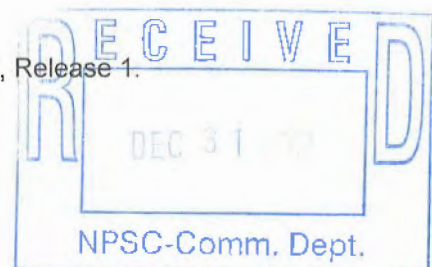

UNITED TELEPHONE COMPANY OF THE WEST - NEBRASKA d/b/a CENTURYLINK
GENERAL EXCHANGE
PRICE LIST

SECTION 1
PAGE: 22
RELEASE: 1
EFFECTIVE: 01-10-13

ISSUED: 12-28-12

INTEGRATED SERVICES DIGITAL NETWORK (ISDN)

II. PRIMARY RATE INTERFACE (PRI) ⁽¹⁾ (Cont'd) (C)

G. Rates and Charges (Cont'd)

7. Termination Liability Charges (T)

(e) Termination Liability Charges will not apply when a service or rate element under a TDP is disconnected prior to the expiration of a selected service period as a result of a change in tariff jurisdiction and/or a customer requested upgrade to a next generation service offering, under the following conditions: (M)

1. The service period of the new TDP for the new service offering is a period equal to or exceeding the remaining service period of the disconnected TDP, and
2. The service orders to install the new service and disconnect the old service are related together, and there is no lapse in service between installation of the new service and disconnection of the old service, and
3. The service orders to install the new service and disconnect the old service are for the same customer at the same location.

(f) The Company will determine whether the replacement service qualifies as a next generation service offering.

(g) Nonrecurring charges and Service Connection Charges for the new service will apply according to the requirements of the new service. (M)

⁽¹⁾ **Effective January 10, 2013, this service is limited to existing facilities in service at existing locations for current customers.** (N)

(M) Material now appearing on this page was previously found on Page 21, Release 6.

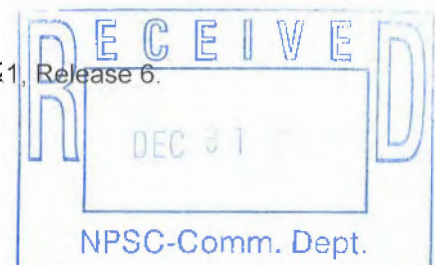

UNITED TELEPHONE COMPANY OF THE WEST d/b/a CENTURYLINK
GENERAL EXCHANGE
PRICE LIST

SECTION 1
PAGE: 23
RELEASE: 2
EFFECTIVE: December 10, 2018

ISSUED: November 30, 2018

INTEGRATED SERVICES DIGITAL NETWORK (ISDN)

III. INTEGRATED SERVICES DIGITAL NETWORK-PRIMARY RATE INTERFACE (ISDN-PRI)
BUSINESS SERVICE

A. General

1. Integrated Services Digital Network - Primary Rate Interface (ISDN-PRI) Business Service ("ISDN-PRI Business Service") is a local exchange offering supported by the ISDN architecture.
2. ISDN-PRI Business Service provides a method of access to the telecommunications network called Primary Rate Access. Primary Rate Access is an ISDN based, DS1 access link to the telecommunications network and provides integration of multiple voice and data transmission channels on the same line. The service provides connectivity between an ISDN-PBX or other ISDN-compatible customer premises equipment ("CPE") and a serving central office. The basic structure for Primary Rate Access is comprised of twenty-three 64 Kbps B-Channels and one 64 Kbps D-Channel, referred to hereafter as "23-B+D". After subscribing to the original 23-B+D configuration, the customer may subscribe to additional ISDN-PRI Business Service arrangements in as 23-B+D or as 24-B Channels. These channels may be used to connect the customer's CPE to the Public Network (i.e., inward/outward trunks, two-way trunks).
3. ISDN-PRI Business Service provides network communication paths that provide the end user with access to a variety of network services and features including data, voice and video which conforms to internationally developed, published, and recognized standards generated by the International Telecommunications Union (ITU).
4. ISDN-PRI Business Service and its optional features and functions are provided within a local access and transport area ("LATA") from central offices where appropriate ISDN facilities are available as determined by the Company. Service inquiries will be necessary to determine availability. Charges Applicable Under Special Conditions may apply as specified in Section 3 of the General Exchange Tariff.

(D)

N

UNITED TELEPHONE COMPANY OF THE WEST - NEBRASKA d/b/a CENTURYLINK
GENERAL EXCHANGE
PRICE LIST

SECTION 1
PAGE: 24
RELEASE: 1
EFFECTIVE: 01-10-13

ISSUED: 12-28-12

INTEGRATED SERVICES DIGITAL NETWORK (ISDN)

III. INTEGRATED SERVICES DIGITAL NETWORK-PRIMARY RATE INTERFACE (ISDN-PRI)
BUSINESS SERVICE (Cont'd)

B. Regulations

1. The minimum service period for ISDN-PRI Business Service is six months. Term Discount Plan commitment periods of one, two, three and five years are available.
2. ISDN-PRI Business Service is not offered in conjunction with Optional Local Measured Service. No additional charges apply for calls to Local Calling Area and Extended Area Service (EAS) exchanges.
3. The customer is responsible for providing CPE that is compatible with ISDN-PRI Business Service.
4. The Company will not be responsible if changes in any of the equipment, operations or procedures of the Company utilized in the provisioning of ISDN-PRI Business Service render any facilities provided by the customer obsolete, require modification or alteration of such equipment or system, or otherwise affect its use or performance.
5. Digital transmission rates at speeds less than those indicated may be accomplished as a function of the particular CPE furnished by the user.
6. Telephone numbers transmitted via the Optional or Standard Incoming Call Identification feature are intended solely for the use of the ISDN-PRI Business Service subscriber. Resale of this call identification information is prohibited.
7. Non-Facility Associated Signaling (NFAS) provides the capability to serve multiple DS1's via a single D-Channel. This feature can be ordered where switch capabilities exist as determined by the Company. When NFAS is selected, the customer must order one ISDN-PRI Business Service arrangement as a 23-B+D arrangement. After the customer subscribes to the initial 23-B+D arrangement, the customer may subscribe to additional arrangements of either 23-B+D or 24 B-Channels. The D-Channel activated on the initial arrangement serves any additional ISDN-PRI Business Service arrangements with no D-Channel. The Company recommends that the number of B-channels supported by a single D-Channel not exceed 95.

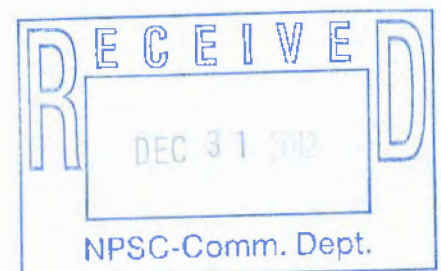

UNITED TELEPHONE COMPANY OF THE WEST - NEBRASKA d/b/a CENTURYLINK
GENERAL EXCHANGE
PRICE LIST

SECTION 1
PAGE: 25
RELEASE: 1
EFFECTIVE: 01-10-13

ISSUED: 12-28-12

INTEGRATED SERVICES DIGITAL NETWORK (ISDN)

III. INTEGRATED SERVICES DIGITAL NETWORK-PRIMARY RATE INTERFACE (ISDN-PRI)
BUSINESS SERVICE (Cont'd)

B. Regulations (Cont'd)

8. This service is available only from central offices which have the necessary facilities to provide ISDN-PRI on the standard network platform. In the event a customer is served by a non-ISDN capable central office, the Company may provide ISDN-PRI Business Service from an alternative serving central office, as designated by the Company. The subscriber may be required to accept a foreign NXX. When a foreign NXX is required, the rates for the interoffice facilities of an interexchange ISDN-PRI Business Service arrangement, as specified in II.G.1. of this Section, will apply in addition to the rates normally applicable for an ISDN-PRI Business Service arrangement. The local calling area may not be the same as the local calling area of the exchange in which the customer is located.

If ISDN functionality becomes available from the central office that normally serves this subscriber, ISDN-PRI Business Service will be provided from that office and the subscriber may be required to accept a different NXX. If the subscriber chooses to continue ISDN-PRI Business Service from the alternative serving central office, the rates for the interoffice facilities of an interexchange ISDN-PRI Business Service arrangement will continue to apply in addition to the rates normally applicable for an ISDN-PRI Business Service Arrangement.

If a subscriber requests ISDN-PRI Business Service from an alternative serving central office other than that designated by the Company, the rates for the interoffice facilities of an interexchange ISDN-PRI Business Service arrangement will apply in addition to the rates normally applicable for an ISDN-PRI Business Service arrangement.

Emergency 911 calls placed over an ISDN-PRI Business Service arrangement that is provisioned via a foreign central office will be identified as originating in the alternative serving central office NXX and not the non-ISDN capable central office NXX. The Company shall not be liable for any loss or damages arising from emergency calls placed from ISDN-PRI Business Service provisioned via an alternative serving central office.

9. ISDN-PRI Business Service is available only where the customer's service location is within the provisioning limitations as determined prior to installation of the service. Should the customer's service location exceed said limitations, service will be provided where the Company has electrically compatible facilities available, or where existing facilities can be made electrically compatible.

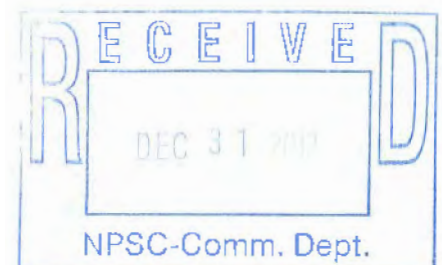

UNITED TELEPHONE COMPANY OF THE WEST - NEBRASKA d/b/a CENTURYLINK
GENERAL EXCHANGE
PRICE LIST

SECTION 1
PAGE: 26
RELEASE: 1
EFFECTIVE: 01-10-13

ISSUED: 12-28-12

INTEGRATED SERVICES DIGITAL NETWORK (ISDN)

III. INTEGRATED SERVICES DIGITAL NETWORK-PRIMARY RATE INTERFACE (ISDN-PRI)
BUSINESS SERVICE (Cont'd)

B. Regulations (Cont'd)

10. One Directory Listing will be provided per D-Channel. Additional Directory Listings are available as specified in Section 4 of the General Exchange Tariff.
11. Temporary Suspension of service at the customer's request, as defined in Section 13 of the General Exchange Tariff, is not available for ISDN-PRI Business Service.
12. In order to maintain the quality of ISDN-PRI Business Service, the Company reserves the right to perform preventative maintenance and software updates to the network. The Company has classified this maintenance as indicated below:
 - (a) Scheduled Maintenance - used to perform such functions as hardware and software upgrades and network optimization. The Company will perform these tasks in a maintenance window that is anticipated to minimize disruption of customer service and activity. The Company will provide advance notice of all scheduled maintenance.
 - (b) Demand Maintenance - may occur as a result of unexpected events and is used when ISDN-PRI network elements are in jeopardy. The Company will perform this type of maintenance at its discretion. Due to the nature of demand maintenance prior notification may not be possible.
13. Rotary hunt functionality is available with ISDN-PRI Business Service at no additional charge. This functionality increases the likelihood of an incoming call being completed over an ISDN-PRI B-channel by allowing calls made to a busy number to be completed to another idle line. This functionality is exclusively within the B-channels of a single ISDN-PRI Business Service arrangement or between multiple ISDN-PRI Business Service arrangements and is not allowed between ISDN-PRI Business Service arrangements and other services, including but not limited to, Business Individual Line Service. The total number of Primary Rate Interfaces in a single, standard hunting configuration may not exceed 50.
14. Relocation of an ISDN-PRI Business Service arrangement to a new location with the same building or to a different location within the same central office serving area is considered a "move" and a Move Charge will apply for each ISDN-PRI Business Service arrangement that is relocated. Customer requested moves to a location in a different central office serving area are treated as disconnections at the existing location, and service establishment charges will apply for each ISDN-PRI Business Service arrangement established at the new location.

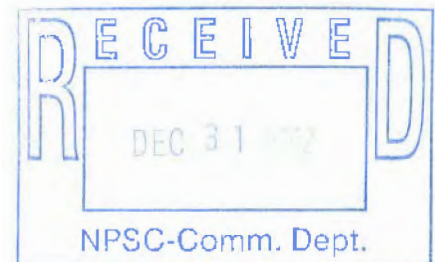

UNITED TELEPHONE COMPANY OF THE WEST - NEBRASKA d/b/a CENTURYLINK
GENERAL EXCHANGE
PRICE LIST

SECTION 1
PAGE: 27
RELEASE: 1
EFFECTIVE: 01-10-13

ISSUED: 12-28-12

INTEGRATED SERVICES DIGITAL NETWORK (ISDN)

III. INTEGRATED SERVICES DIGITAL NETWORK-PRIMARY RATE INTERFACE (ISDN-PRI)
BUSINESS SERVICE (Cont'd)

C. Definitions

1. B-Channel - A bi-directional synchronous channel capable of supporting 64 Kbps of digital transmission.
2. D-Channel - A digital, signaling-only channel for call establishment that is capable of supporting 64 Kbps of digital transmission.
3. Primary Rate Access Line – The facility between the serving central office and the customer's premises. Provides transport for up to twenty-four 64 Kbps.
4. Primary Rate Interface – The central office switching elements that are dedicated to a customer's ISDN-PRI Business Service.
5. Primary Rate Channels – B-Channels or D-Channels, as defined above.
6. Rotary Hunt Functionality - A service arrangement which allows calls made to a busy number to be completed to another idle line in that rotary number group.

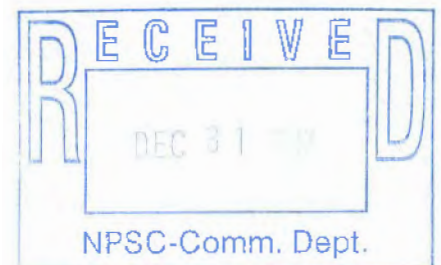

UNITED TELEPHONE COMPANY OF THE WEST - NEBRASKA d/b/a CENTURYLINK
GENERAL EXCHANGE
PRICE LIST

SECTION 1
PAGE: 28
RELEASE: 1
EFFECTIVE: 01-10-13

ISSUED: 12-28-12

INTEGRATED SERVICES DIGITAL NETWORK (ISDN)

III. INTEGRATED SERVICES DIGITAL NETWORK-PRIMARY RATE INTERFACE (ISDN-PRI)
BUSINESS SERVICE (Cont'd)

D. Features

1. Standard Features

Clear Channel Capability – Allows all 64 Kbps on each B-Channel to be used for Customer information because the B-Channels on ISDN-PRI Business Service are clear as a result of all signaling and control functions being handled by a D-Channel.

D-Channel Control – Permits a single D-Channel to provide signaling and control for one or more ISDN-PRI Business Service arrangements when, after subscribing to an initial 23-B+D configuration, a customer requests additional arrangements consisting of 24 B-Channels.

Digital Voice Transmission - All voice calls are transmitted using digital signaling.

Direct Inward Dialing (DID) Signaling - Permits incoming dialed calls from the exchange network to reach a specific number served by CPE without the assistance of an attendant. The central office will outpulse digits to the CPE that can further process the calls as desired. The rates and charges for DID telephone numbers are in addition to the ISDN charges and are provided in Section 11 of this tariff.

Dynamic Allocation of Bandwidth - Allows the voice and data services to share B-Channels and arrange them as a single trunk group. This allows incoming and outgoing voice and data calls to utilize B-Channels on a call by call basis. Without this capability, each service will have a dedicated B-Channel.

Incoming Call Identification (Caller ID Number Only) – Provides a customer with the telephone number of the calling party. Incoming call identification is provided via the D-Channel associated with an incoming call on a B-Channel to a PBX and is subject to availability and provision by the originating call's carrier's facilities. Customer's CPE must be compatible with this feature.

PBX Station ID Capability - Allows the station user's (calling party's) number to be transmitted over the ISDN-PRI D-Channel from Direct Inward Dialing equipped CPE PBXs that use ISDN-PRI. This number is provided by the originating station and must have an associated Direct Inward Dialing telephone number working in the central office.

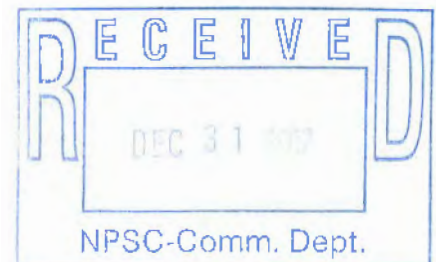

UNITED TELEPHONE COMPANY OF THE WEST d/b/a CENTURYLINK
GENERAL EXCHANGE
PRICE LIST

SECTION 1
PAGE: 29
RELEASE: 2

ISSUED: November 30, 2018

EFFECTIVE: December 10, 2018

INTEGRATED SERVICES DIGITAL NETWORK (ISDN)

III. INTEGRATED SERVICES DIGITAL NETWORK-PRIMARY RATE INTERFACE (ISDN-PRI)
BUSINESS SERVICE (Cont'd)

D. Features

2. Optional Features

2 B-Channel Transfer – Provides specific central office switching capabilities. For example, when a call terminates at a given location, but is then forwarded to another location, two trunks between the Central Office and the original device are typically employed for the duration of the forwarded call. 2 B-Channel Transfer allows the central office switch to establish the call directly to the final destination and release the trunks going in and out of the forwarding device. A common use of 2 B-Channel Transfer is illustrated below.

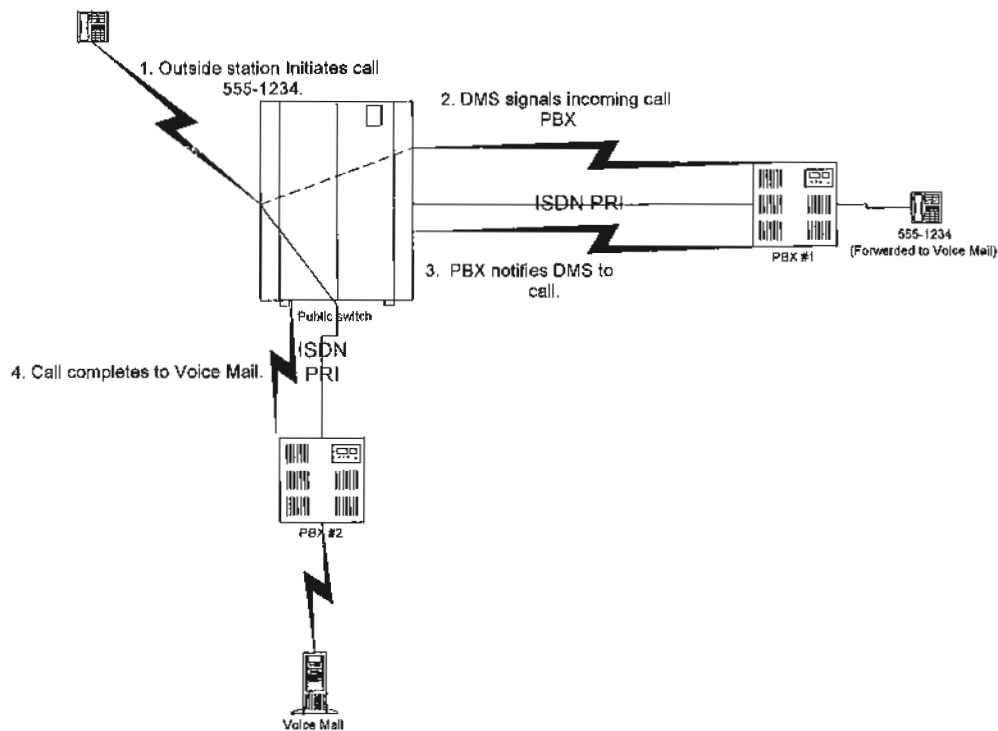

Call-by-Call/Integrated Service Access Feature Capability - Allows the customer to dynamically allocate the use of channels for ISDN-PRI Business Service. The customer may also choose voice or data transmission on a per call basis. In addition, the customer may also choose to subscribe to more services than channels. The CPE signals the local central office as to which type of service (e.g., via inward/outward **trunk**) to access for each call. This feature is only available with two-way Primary Rate Interface.

(D)

UNITED TELEPHONE COMPANY OF THE WEST - NEBRASKA d/b/a CENTURYLINK
GENERAL EXCHANGE
PRICE LIST

SECTION 1
PAGE: 30
RELEASE: 1
EFFECTIVE: 01-10-13

ISSUED: 12-28-12

INTEGRATED SERVICES DIGITAL NETWORK (ISDN)

III. INTEGRATED SERVICES DIGITAL NETWORK-PRIMARY RATE INTERFACE (ISDN-PRI)
BUSINESS SERVICE (Cont'd)

D. Features (Cont'd)

2. Optional Features (Cont'd)

Circular Hunt - Provides the most efficient hunting sequence available, and allows for much larger trunk groups than the standard ISDN-PRI Business Service packages. With circular hunt, an incoming call is completed to the next available trunk (bearer) in sequence starting from the last trunk selected. This can occur across multiple PRI facilities. The feature can support up to 220 Primary Rate Interfaces in a single hunting configuration. The standard limit is 50.

D-Channel Backup - Provides backup for the D-Channel for a customer with multiple ISDN-PRI Business Service arrangements by automatically switching signaling capability over to a back-up D-Channel if service to the primary D-Channel is interrupted.

E911 Call Screening - Provides for the transmission of PBX or Key System station information via the ISDN-PRI facility to local emergency services authorities. This provides for the possible identification of the specific location on a customer's premises where a 911 call originated. This option is available only in communities where local emergency authorities support the service in conjunction with the Company's Private Switch Database Service, associated with E911 Service. This service is only available in conjunction with National ISDN-2 Protocol.

Incoming Call Identification (Caller ID Name and Number) - Provides the customer with the telephone number and name of the calling party, subject to availability and provision by the originating caller's carrier. Incoming call identification is provided via the D-Channel associated with an incoming call on a B-Channel to a PBX. The Customer's equipment must be compatible with this feature.

Main Number ID Capability - Available in lieu of the standard PBX Station ID Capability feature, this feature allows only the main number associated with an ISDN-PRI Business Service arrangement to be transmitted and available for display when a call is placed from any station associated with an ISDN-PRI Business Service arrangement.

National ISDN-2 Protocol - A communication protocol that governs interactions between the customer's equipment and the telephone network. This protocol is more advanced than the standard ISDN-PRI protocol. Most CPE is capable of using the ISDN-2 Protocol.

Network Ring Again - Enables the customer to complete calls to a busy station without continually redialing. Certain equipment restrictions may apply.

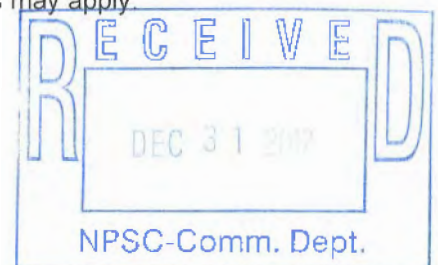

UNITED TELEPHONE COMPANY OF THE WEST d/b/a CENTURYLINK
GENERAL EXCHANGE
PRICE LIST

SECTION 1
PAGE: 31
RELEASE: 2

ISSUED: November 30, 2018

EFFECTIVE: December 10, 2018

INTEGRATED SERVICES DIGITAL NETWORK (ISDN)

III. INTEGRATED SERVICES DIGITAL NETWORK-PRIMARY RATE INTERFACE (ISDN-PRI)
BUSINESS SERVICE (Cont'd)

E. Service Components

1. Each ISDN-PRI Business Service arrangement consists of the following functional components:

- Primary Rate Access Line
- Primary Rate Interface
- Primary Rate Channels

(a) Primary Rate Access Line - Provides a four-wire access loop from the customer premises to the serving central office. The transmission via this loop supports Clear Channel Capability. One Primary Rate Access Line is provided for every 24 channels.

(b) Primary Rate Interface - Provides the multiplexing to support up to twenty-three B-Channels at 64 Kbps and one D-Channel for signaling also at 64 Kbps. When NFAS is ordered, the Primary Rate Interface can provide up to twenty-four B-Channels at 64 Kbps. Primary Rate Interfaces will be provisioned as two-way.

(c) Primary Rate Channels - The initial ISDN-PRI Business Service arrangement consists of a 23-B+D configuration, with unlimited usage that will allow either voice or data transmission up to 64 Kbps. Additional arrangements may be ordered as either 23-B+D or 24-B Channel arrangements.

(1) Voice calls may be completed to both ISDN and non-ISDN lines.

(2) Data Transmission on the B-Channels will be at 64 Kbps within the switch and between ISDN-PRI compatible central offices. ISDN-PRI interconnection to non-ISDN-PRI equipped central offices may be potentially subjected to analog transmission or sub-rated to 56 Kbps.

2. Each Primary Rate Access Line may be active with a corresponding number of services (e.g., inward/outward **trunks**) selected. The customer may also choose to subscribe to more services than channels. The CPE signals the local central office as to which type of service (inward/outward **trunk**) to access for each call.

(D)
|
(D)

(D)

(D)

UNITED TELEPHONE COMPANY OF THE WEST - NEBRASKA d/b/a CENTURYLINK
GENERAL EXCHANGE
PRICE LIST

SECTION 1
PAGE: 32
RELEASE: 1
EFFECTIVE: 01-10-13

ISSUED: 12-28-12

INTEGRATED SERVICES DIGITAL NETWORK (ISDN)

III. INTEGRATED SERVICES DIGITAL NETWORK-PRIMARY RATE INTERFACE (ISDN-PRI)
BUSINESS SERVICE (Cont'd)

F. Application of Rates

1. Nonrecurring charges will not be applicable for ISDN-PRI Business Service arrangements that are updated from an existing Primary Rate Access Line 1.544 Mbps service to ISDN-PRI Business Service.
2. The initial ISDN-PRI Business Service arrangement at any location must be configured as 23-B+D, after which additional arrangements may be ordered as either 23-B+D or as 24-B Channels.
3. Rates and charges for optional features and functions are applied to each ISDN-PRI Business Service arrangement for which a separate Primary Rate Interface is required. For example, when a customer has the initial 23-B+D arrangement and an additional arrangement configured as 24-B Channels, two Primary Rate Interfaces are provided. The feature charge applies for each Primary Rate Interface over which the optional feature is activated.

G. Rates and Charges

1. ISDN-PRI Business Service Arrangement

An ISDN-PRI Business Service Arrangement is furnished between a serving central office and the customer's designated premises. The customer must initially subscribe to a 23-B+ D configuration per location, after which additional arrangements may be ordered as 23-B+D or 24-B Channels.

The rates, charges and regulations for a 1.544 Mbps service **interoffice channel**, as specified in the Company's Access Service Tariff, apply in addition to the following rates for the interoffice facilities of an interexchange ISDN-PRI Business Service arrangement.

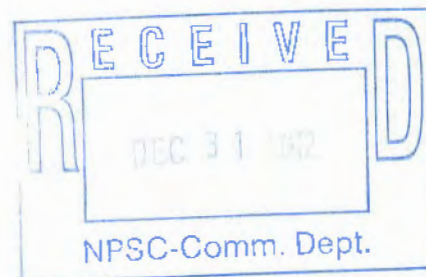

UNITED TELEPHONE COMPANY OF THE WEST - NEBRASKA d/b/a CENTURYLINK
GENERAL EXCHANGE
PRICE LIST

SECTION 1
PAGE: 33
RELEASE: 1
EFFECTIVE: 01-10-13

ISSUED: 12-28-12

INTEGRATED SERVICES DIGITAL NETWORK (ISDN)

III. INTEGRATED SERVICES DIGITAL NETWORK-PRIMARY RATE INTERFACE (ISDN-PRI)
BUSINESS SERVICE (Cont'd)

G. Rates and Charges (Cont'd)

1. ISDN-PRI Business Service Arrangement (Cont'd)

(a) ISDN-PRI Business Service Arrangement with Two-Way Primary Rate Interface
(23-B+D and 24-B Channels)

	<u>Monthly Rate</u>	<u>Nonrecurring Charge (Initial)</u>	<u>Nonrecurring Charge Add'l*</u>
Month-to-month**	\$1,200.00	\$650.00	\$0.00
One Year	1,100.00	450.00	0.00
Two Years	1,015.00	250.00	0.00
Three Years	945.00	0.00	0.00
Five Years	885.00	0.00	0.00

* Additional facilities must be installed at the same customer designated premises on the same trip and placed on the same service order.

** Month-to-month customers must subscribe to ISDN-PRI Business Service for a minimum service period of six months.

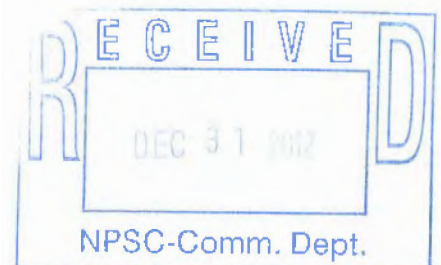

UNITED TELEPHONE COMPANY OF THE WEST - NEBRASKA d/b/a CENTURYLINK
GENERAL EXCHANGE
PRICE LIST

SECTION 1
PAGE: 34
RELEASE: 1
EFFECTIVE: 01-10-13

ISSUED: 12-28-12

INTEGRATED SERVICES DIGITAL NETWORK (ISDN)

III. INTEGRATED SERVICES DIGITAL NETWORK-PRIMARY RATE INTERFACE (ISDN-PRI)
BUSINESS SERVICE (Cont'd)

G. Rates and Charges (Cont'd)

b. Optional Features

		<u>Monthly Rate</u>	<u>Nonrecurring Charge</u>	
(1)	2 B-Channel Transfer ⁽¹⁾ Per Primary Rate Interface	\$ 75.00	\$100.00	(M)
(2)	Call-by-Call/Integrated Service Access Feature Capability Per Primary Rate Interface (Available with Two-Way Primary Rate Interface only)	50.00	35.00	
(3)	Circular Hunt ⁽¹⁾ Per Primary Rate Interface	25.00	0.00	(R)
(4)	D-Channel Backup ⁽²⁾ each channel	50.00	20.00	
(5)	E911 Call Screening ⁽¹⁾ Per Primary Rate Interface (up to 100 station numbers)	125.00	0.00	(R)
(6)	Incoming Call Identification (Caller ID Name and Number) Per Primary Rate Interface	100.00	0.00	(M)
(7)	Main Number ID Capability	0.00	0.00	(N)
(8)	National ISDN-2 Protocol ⁽¹⁾ Per Primary Rate Interface	0.00	0.00	(M)
(9)	Network Ring Again ⁽¹⁾ Per Primary Rate Interface (Available with Two-Way Primary Rate Interface only)	160.00	0.00	

⁽¹⁾ Certain equipment restrictions apply.

⁽²⁾ Available only to customers subscribing to more than one Primary Rate Interface.

(M) Material previously appeared on Page 19, Release 4, and Page 19.1, Release 4.

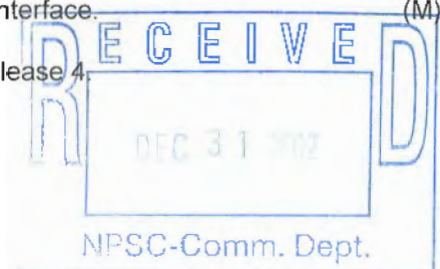

UNITED TELEPHONE COMPANY OF THE WEST - NEBRASKA d/b/a CENTURYLINK
 GENERAL EXCHANGE
 PRICE LIST

SECTION 1
 PAGE: 35
 RELEASE: 1
 EFFECTIVE: 01-10-13

ISSUED: 12-28-12

INTEGRATED SERVICES DIGITAL NETWORK (ISDN)

III. INTEGRATED SERVICES DIGITAL NETWORK-PRIMARY RATE INTERFACE (ISDN-PRI)
 BUSINESS SERVICE (Cont'd)

G. Rates and Charges (Cont'd)

3. Optional Feature Packages

	<u>Monthly Rate</u>	<u>Nonrecurring Charge</u>	
(a) <u>Premium Package*</u> Includes: National ISDN-2 Protocol** E911 Call Screening** Incoming Call Identification (Caller ID Name and Number) Call-by-Call/Integrated Service Access Feature Capability 2 B-Channel Transfer**			(M)

Per Primary Rate Interface	\$195.00	\$150.00	(R) (M)
----------------------------	----------	----------	---------

4. Service Charges

(a) Service Establishment Charges apply when a customer requests establishment of a new ISDN-PRI Business Service arrangement(s) Service Establishment Charges apply for each ISDN-PRI Business Service Arrangement that is separately ordered and/or installed. Service Establishment Charges consist of:

- (1) A Service Order Charge, as described in Section 18 of the General Exchange Tariff applies for each order placed, for receiving and recording information, and processing the necessary data in connection with a customer's request for service establishment; and
- (2) The applicable Nonrecurring Charge for an ISDN-PRI Business Service Arrangement. This charge covers engineering design, common centralized testing and coordination. Nonrecurring charges do not apply for additional ISDN-PRI Business Service Arrangements installed at the same customer designated premises on the same trip and placed on the same service order.

(b) Premises Visit Charges are applicable per ISDN-PRI Business Service arrangement, for the termination of a channel at a customer's premises or for termination change at the same premises. Only one Premises Visit Charge applies when more than one channel service of the same type is terminated or moved at the same premises at the same time.

Premises Visit Charge, per ISDN-PRI Business Service Arrangement		\$125.00	
---	--	----------	--

* Only available for customers whose ISDN-PRI Business Service arrangements include a Two-Way Primary Rate Interface under a Term Discount Plan.
 ** Certain equipment restrictions apply.

(M) Material previously appeared on Page 19.1, Release 4.

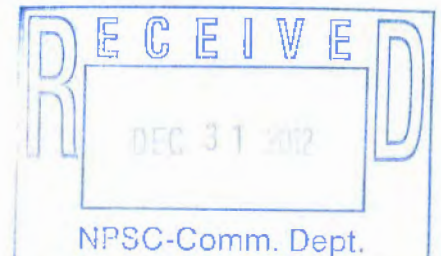

UNITED TELEPHONE COMPANY OF THE WEST - NEBRASKA d/b/a CENTURYLINK
GENERAL EXCHANGE
PRICE LIST

SECTION 1
PAGE: 36
RELEASE: 1
EFFECTIVE: 01-10-13

ISSUED: 12-28-12

INTEGRATED SERVICES DIGITAL NETWORK (ISDN)

III. INTEGRATED SERVICES DIGITAL NETWORK-PRIMARY RATE INTERFACE (ISDN-PRI)
BUSINESS SERVICE (Cont'd)

G. Rates and Charges (Cont'd)

4. Service Charges (Cont'd)

(c) Service Change Charges are applicable for receiving and recording information and/or taking action in connection with a customer's termination change at the same premises or transfer of service responsibility request, for processing the necessary data on an existing ISDN-PRI Business Service. A Service Change Charge is applicable for each ISDN-PRI Business Service associated with the customer request (in lieu of a Service Establishment Charge).

(1) For termination change at the same premises,
Physical, per ISDN-PRI Business Service arrangement \$165.00

(2) For termination change at the same premises,
Programming, per ISDN-PRI Business Service arrangement \$35.00

(d) Move Charges apply for each ISDN-PRI Business Service arrangement moved to a new location in the same building or to a different location within the same central office serving area. The Move Charge is equal to the sum of the Service Change Charges plus the Premises Visit Charge.

H. Term Discount Plan (TDP)

1. Description

(a) TDP commitment periods of one, two, three, and five years are available.

(b) A Customer may extend a TDP commitment period at any time during the term of a TDP. The number of months accrued under the current TDP will apply toward the commitment period of the new TDP. The rates under the new TDP will not apply retroactively toward the months accrued under the current TDP.

(c) At the end of the TDP service commitment period, the customer may subscribe to a new TDP at the then prevailing tariffed rates. If the customer does not select a new TDP, the prevailing rates applicable for the expired TDP will continue in effect for as long as the customer chooses to continue subscribing to the ISDN-PRI Business Service arrangements installed under the expired TDP. Additional ISDN-PRI Business Service arrangements installed after the TDP expiration date will not be eligible for the TDP rates and will be charged at the prevailing Month-to-month rates unless the customer selects a TDP for those services.

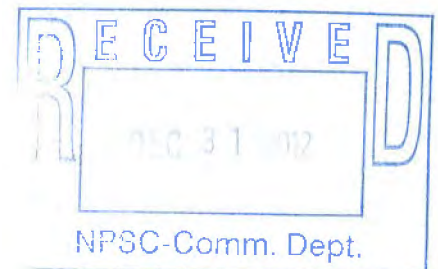

UNITED TELEPHONE COMPANY OF THE WEST - NEBRASKA d/b/a CENTURYLINK
GENERAL EXCHANGE
PRICE LIST

SECTION 1
PAGE: 37
RELEASE: 1
EFFECTIVE: 01-10-13

ISSUED: 12-28-12

INTEGRATED SERVICES DIGITAL NETWORK (ISDN)

III. INTEGRATED SERVICES DIGITAL NETWORK-PRIMARY RATE INTERFACE (ISDN-PRI)
BUSINESS SERVICE (Cont'd)

H. Term Discount Plan (TDP) (Cont'd)

2. Rate Changes

- (a) Rate increases or decreases will be automatically applied to the monthly TDP rates for the remaining term of a TDP.
- (b) If Company initiated rate increase(s) to any rate element or combination of rate elements causes the charges for the entire ISDN-PRI Business Service arrangement under the TDP to increase by 10% or more in any plan year, Customer may cancel the TDP without incurring Early Termination Liability Charges provided Customer notifies the Company within 30 days after the effective date of the rate increase. The first 12 months of a TDP commitment period constitute a plan year. Each subsequent 12 month increment constitutes an additional plan year.

3. Early Termination Liability

(a) Calculation of Early Termination Liability

If a TDP Customer disconnects all or a portion of the ISDN-PRI Business Service before the expiration of a TDP, then a Termination Liability Charge will apply to those services which are disconnected. The Termination Liability Charge will be a one-time charge equal to the sum of 50% of the payments remaining for the rest of the TDP. If Special Construction Charges were applied to the service being terminated, any termination charges associated with Charges Applicable Under Special Conditions will also apply.

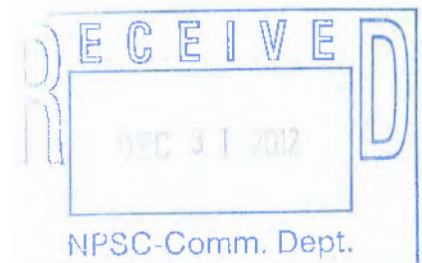

UNITED TELEPHONE COMPANY OF THE WEST - NEBRASKA d/b/a CENTURYLINK
GENERAL EXCHANGE
PRICE LIST

SECTION 1
PAGE: 38
RELEASE: 1
EFFECTIVE: 01-10-13

ISSUED: 12-28-12

INTEGRATED SERVICES DIGITAL NETWORK (ISDN)

III. INTEGRATED SERVICES DIGITAL NETWORK-PRIMARY RATE INTERFACE (ISDN-PRI)
BUSINESS SERVICE (Cont'd)

H. Term Discount Plan (TDP) (Cont'd)

3. Early Termination Liability (Cont'd)

(a) Waiver of Early Termination Liability

(1) Customers will not be liable for Early Termination Liability under the following circumstances:

(i) Relocation within Central Office Serving Area

If a TDP Customer relocates an existing Service arrangement to a new location within the same building or to a different location within the same central office serving area prior to the expiration of a TDP, a Termination Liability Charge will not apply, and the number of months accrued at the prior location will carry over to the new location. Move Charges will apply for each arrangement relocated.

(ii) Relocation to Different Central Office Serving Area

If a TDP Customer relocates an existing Service arrangement to a location in a different central office serving area, a Termination Liability Charge will not apply if Customer converts to a new TDP commitment period that is equal to or greater than the original TDP commitment period. The number of months accrued at the prior location under the original TDP will not carry over to the new location. Service Establishment Charges will apply for the ISDN-PRI Business Service arrangement(s) installed at the new location.

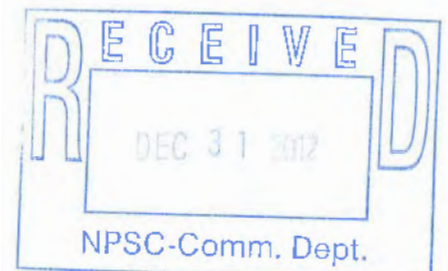

UNITED TELEPHONE COMPANY OF THE WEST - NEBRASKA d/b/a CENTURYLINK
GENERAL EXCHANGE
PRICE LIST

SECTION 1
PAGE: 39
RELEASE: 1
EFFECTIVE: 01-10-13

ISSUED: 12-28-12

INTEGRATED SERVICES DIGITAL NETWORK (ISDN)

III. INTEGRATED SERVICES DIGITAL NETWORK-PRIMARY RATE INTERFACE (ISDN-PRI)
BUSINESS SERVICE (Cont'd)

H. Term Discount Plan (TDP) (Cont'd)

3. Early Termination Liability (Cont'd)

(b) Waiver of Early Termination Liability (Cont'd)

(1) Customers will not be liable for Early Termination Liability under the following circumstances (cont'd):

(iii) Technology Upgrade

- a) When a service or rate element under a TDP arrangement is disconnected prior to the expiration of the TDP commitment period as a result of a change in tariff jurisdiction and/or a customer requested upgrade to a next generation service offering, Termination Liability Charges will not apply under the following conditions:

The service period of the new TDP for the new service offering is a period equal to or exceeding the remaining service period of the disconnected TDP, and

The service orders to install the new service and disconnect the old service are related, and there is no lapse in service between the installation of the new service and the disconnection of the old service, and

The service orders to install the new service and disconnect the old service are for the same Customer at the same location.

- b) The Company will determine whether a replacement service qualifies as a next generation service offering.
- c) Nonrecurring charges and Service Charges for the new service will apply according to the requirements of the new service.

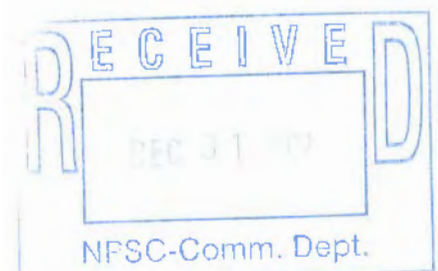

UNITED TELEPHONE COMPANY OF THE WEST - NEBRASKA
GENERAL EXCHANGE
PRICE LIST

SECTION 2
PAGE: 1
RELEASE: 14
EFFECTIVE: March 1, 2022

ISSUED: February 17, 2022

SPECIAL PACKAGED OFFERINGS

As of March 1, 2022, changes, additions, or transfer of service will not be permitted on accounts associated with a grandfathered bundle or package or other grandfathered feature or service. This change does not impact services or features currently provided on grandfathered accounts. A grandfathered service is one that is no longer sold, and availability is limited to lines currently in service at existing locations. Changes, additions, or transfer of service will be allowed when customers migrate from a grandfathered service to a currently available service. Customers may remove any service or feature from their accounts at any time; however, grandfathered services removed may not be subsequently reinstated.

(N)

(N)

A. SOLUTIONS - RESIDENCE

I. GENERAL

- A. Solutions is an optional residence service enrollment plan that permits a customer to receive Flat Rate Residence Individual Line Local Exchange Service plus features for a flat monthly rate, for each Solutions Package residence line provided.

II. REGULATIONS

- A. Solutions customers may terminate their enrollment in the Plan at any time upon notice to the Company, subject to the General Rules and Regulations Applying to Telephone Service, Prorating of Bills, described in the Company's General Exchange Tariff.
- B. Unless terminated by the Solutions customer or the Company, a customer will remain enrolled in the Plan, as amended from time-to-time, with any applicable changes in rate, for as long as the Plan continues to be offered by the Company.
- C. This Plan is not available with Residential ISDN-BRI Service lines or to customers who are or become toll restricted.
- D. No more than four (4) residence lines can be enrolled with the Solutions option for each customer Billed Telephone Number account.
- E. Service Connection Charges do not apply when Solutions replaces existing Local Exchange Service or if the customer requests a change from Solutions back to regulated Local Exchange Service. Service Connection Charges as specified in Section 18 of the Company's General Exchange Tariff apply for new and additional Solutions lines and moves of existing Solutions lines, except for Pure Bundle lines. No Service Connection Charges apply for installation of Pure Bundle.
- F. Solutions customers are not eligible for promotional offerings associated with the Custom Calling Services included in this Plan, unless specifically provided for in a promotional offering.

UNITED TELEPHONE COMPANY OF THE WEST – NEBRASKA d/b/a CENTURYLINK
GENERAL EXCHANGE
PRICE LIST

SECTION 2
PAGE: 1.1
RELEASE: 5

ISSUED: January 7, 2010

EFFECTIVE: January 17, 2010

SPECIAL PACKAGED OFFERINGS

A. SOLUTIONS – RESIDENCE (Cont'd)

This page is reserved for future use.

(T)

(D)

(D)

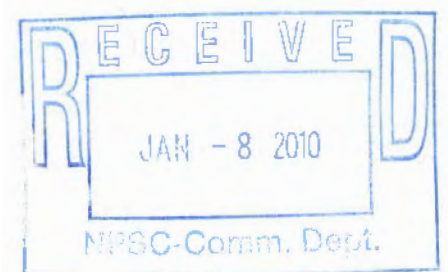

UNITED TELEPHONE COMPANY OF THE WEST - NEBRASKA d/b/a CENTURYLINK
GENERAL EXCHANGE
PRICE LIST

SECTION 2
PAGE: 2
RELEASE: 21

ISSUED: October 9, 2020

EFFECTIVE: October 19, 2020

SPECIAL PACKAGED OFFERINGS

A. SOLUTIONS - RESIDENCE (Cont'd)

III. SOLUTIONS PACKAGE DESCRIPTION

(T)
(D)
(D)

See Section A.IV. for applicable Solutions Package rates.

(N)

A. Core Solution – GRANDFATHERED ^[1]

(M)(T)

Local Exchange Service
Enhanced Call Waiting - Optional
Call Forwarding
Three-Way Calling
Caller ID with Name (includes Anonymous Call Rejection)
Repeat Dial
Return Call
Call Forward No Answer - Fixed
Call Forward Busy - Fixed
Speed Dial 8
Selective Call Acceptance
Selective Call Forwarding
Selective Call Ring
Selective Call Rejection

[1] Effective March 18, 2007, this service will no longer be available for new installations. As of July 15, 2011, this service is limited to lines in service for existing customers.

(D)
(D)
(T)

(M) Monthly rates for Residence Solutions Packages moved to Page 2.9 of this section.

UNITED TELEPHONE COMPANY OF THE WEST - NEBRASKA d/b/a CENTURYLINK
GENERAL EXCHANGE
PRICE LIST

SECTION 2
PAGE: 2.1
RELEASE: 22

ISSUED: October 9, 2020

EFFECTIVE: October 19, 2020

SPECIAL PACKAGED OFFERINGS

A. SOLUTIONS - RESIDENCE

III. SOLUTIONS PACKAGE DESCRIPTION (Cont'd)

(T)

(D)

(D)

B. Personal II Solution – GRANDFATHERED ^[1]

(M)(T)

Local Exchange Service
Enhanced Call Waiting - Optional
Call Waiting ID
Call Forwarding
Three-Way Calling
Caller ID with Name (includes Anonymous Call Rejection)
Return Call
Repeat Dial
Call Forward No Answer - Fixed
Call Forward Busy - Fixed
Selective Call Forward

C. Home II Solution – GRANDFATHERED ^[1]

(M)(T)

Local Exchange Service
Enhanced Call Waiting - Optional
Call Waiting ID
Three-Way Calling
Caller ID with Name (includes Anonymous Call Rejection)
Call Forward No Answer - Fixed
Call Forward Busy - Fixed

^[1] Effective June 20, 2008, this service will no longer be available for new installations. As of July 15, 2011, this service is limited to lines in service for existing customers.

(M) Monthly rates for Residence Solutions Packages moved to Page 2.9 of this section.

(D)

(D)

(T)

UNITED TELEPHONE COMPANY OF THE WEST - NEBRASKA d/b/a CENTURYLINK
GENERAL EXCHANGE
PRICE LIST

SECTION 2
PAGE: 2.2
RELEASE: 15

ISSUED: October 9, 2020

EFFECTIVE: October 19, 2020

SPECIAL PACKAGED OFFERINGS

A. SOLUTIONS - RESIDENCE (Cont'd)

III. SOLUTIONS PACKAGE DESCRIPTION (Cont'd)

(T)

D. Reserved

(T)

UNITED TELEPHONE COMPANY OF THE WEST - NEBRASKA d/b/a CENTURYLINK
GENERAL EXCHANGE
PRICE LIST

SECTION 2
PAGE: 2.3
RELEASE: 19

ISSUED: October 9, 2020

EFFECTIVE: October 19, 2020

SPECIAL PACKAGED OFFERINGS

A. SOLUTIONS - RESIDENCE (Cont'd)

III. SOLUTIONS PACKAGE DESCRIPTION (Cont'd)

(T)

(D)

(D)

E. Special Plan Bundle – GRANDFATHERED ^[2]

(M)(T)

Local Exchange Service
Enhanced Call Waiting - Optional
Caller ID with Name (includes Anonymous Call Rejection)
Call Forwarding
Call Forward No Answer - Fixed
Call Forward Busy - Fixed
Return Call
Call Waiting ID
Repeat Dial
Selective Call Acceptance

F. Progressive Plan ^[1] – GRANDFATHERED ^[3]

(M)(T)

Local Exchange Service
Enhanced Call Waiting - Optional
Call Waiting ID
Three-Way Calling
Caller ID with Name (includes Anonymous Call Rejection)
Call Forwarding
Call Forward No Answer - Fixed
Call Forward Busy – Fixed

(D)

(D)

(M)

|

(M)

(T)

^[1] Effective January 29, 2007, new customers must also subscribe to Voicemail. If Voicemail is not available, one of the following features may be substituted: Home Phone Warranty, LineGuard or Data LineGuard.

^[2] Effective June 20, 2008, this service will no longer be available for new installations. As of July 15, 2011, this service is limited to lines in service for existing customers.

^[3] As of July 15, 2011, this service is limited to lines in service for existing customers.

(M) Monthly rates for Residence Solutions Packages moved to Page 2.9 of this section.

UNITED TELEPHONE COMPANY OF THE WEST - NEBRASKA d/b/a CENTURYLINK
GENERAL EXCHANGE
PRICE LIST

SECTION 2
PAGE: 2.4
RELEASE: 17

ISSUED: October 9, 2020

EFFECTIVE: October 19, 2020

SPECIAL PACKAGED OFFERINGS

A. SOLUTIONS - RESIDENCE (Cont'd)

III. SOLUTIONS PACKAGE DESCRIPTION (Cont'd)

(T)

(D)

(D)

G. Simple Solution – GRANDFATHERED ^[2]

(M)(T)

Local Exchange Service

Caller ID with Name (includes Anonymous Call Rejection)

Speed Dial 8

(M)(T)

H. Follow Me Plan ^[1] – GRANDFATHERED ^[2]

Local Exchange Service

Enhanced Call Waiting - Optional

Call Waiting ID

Three-Way Calling

Caller ID with Name (includes Anonymous Call Rejection)

Call Forward No Answer-Fixed

Call Forward Busy-Fixed

Return Call

Repeat Dial

(D)

(D)

(T)

^[1] Customers must also subscribe to the Company's non-regulated Voicemail with Integrated Calling Features (ICF). This bundle is only available where Voicemail with ICF is technically feasible.

^[2] As of July 15, 2011, this service is limited to lines in service for existing customers.

(T)

(M) Monthly rates for Residence Solutions Packages moved to Page 2.9 of this section.

UNITED TELEPHONE COMPANY OF THE WEST d/b/a CenturyLink
NEBRASKA
GENERAL EXCHANGE PRICE LIST

SECTION 2
PAGE: 2.5
RELEASE: 12
EFFECTIVE: October 19, 2020

ISSUED: October 9, 2020

SPECIAL PACKAGED OFFERINGS

A. SOLUTIONS - RESIDENCE (Cont'd)

- III. **SOLUTIONS PACKAGE DESCRIPTION** (Cont'd) (T)
- (D)
- (D)
- I. Essential Home Phone Plan – GRANDFATHERED ^[1] (M)(T)
Local Exchange Service
Caller ID with Name (includes Anonymous Call Rejection)
Call Waiting ID (optional)
Enhanced Call Waiting
Speed Dial 8
- J. Pure Bundle – GRANDFATHERED ^[2] (M)(T)
Local Exchange Service
Outbound Call Block Feature
Non-Published Directory Listing
Billed Number Screening (optional)
- K. Simple Choice Bundle ^[3] – **GRANDFATHERED** ^[4] (M)(T)
Local Exchange Service
Choice of Available Custom Calling or ExpressTouch Features

^[1] As of July 15, 2011, this service is limited to lines in service for existing customers. (D)

^[2] Effective June 11, 2017, Pure Bundle is grandfathered for residential customers. Availability to current customers is limited to lines in service at existing locations. (D)

^[3] The customer must also subscribe to the Embarq Communications, Inc. Easy Talk Simple Choice Long Distance plan. (T)

^[4] As of December 26, 2014, this service is limited to lines in service for existing customers. (M)

(M) Monthly rates for Residence Solutions Packages moved to Page 2.9 of this section. (M)

UNITED TELEPHONE COMPANY OF THE WEST d/b/a CENTURYLINK
NEBRASKA
GENERAL EXCHANGE PRICE LIST

SECTION 2
PAGE: 2.6
RELEASE: 4

ISSUED: October 9, 2020

EFFECTIVE: October 19, 2020

SPECIAL PACKAGED OFFERINGS

A. SOLUTIONS - RESIDENCE (Cont'd)

III. SOLUTIONS PACKAGE DESCRIPTION (Cont'd)

(T)

- L. Simple Choice Unlimited Bundle ^{[1][2][3]}
Local Exchange Service
Choice of available Custom Calling
or Express Touch Features

(T)

(M)

⋮

(M)

^[1] As of December 26, 2014, this service is limited to lines in service for existing customers.

(T)

^[2] The customer must also subscribe to the Embarq Communications, Inc. Easy Talk Simple Choice Unlimited Long-Distance plan.

(T)

^[3] **Simple Choice Unlimited Bundle is available at discounted monthly rates when customers also subscribe to Voicemail and/or High-Speed Internet (1.5M or higher) in addition to Embarq Communications, Inc. Easy Talk Unlimited Long Distance plan. See A.IV. following.**

(T)

(T)

(M)

⋮

(M)

(M)

(M) Monthly rates for Residence Solutions Packages moved to Page 2.10 of this section.

UNITED TELEPHONE COMPANY OF THE WEST - NEBRASKA d/b/a CENTURYLINK
GENERAL EXCHANGE
PRICE LIST

SECTION 2
PAGE: 2.7
RELEASE: 7

ISSUED: October 9, 2020

EFFECTIVE: October 19, 2020

SPECIAL PACKAGED OFFERINGS

A. SOLUTIONS - RESIDENCE (Cont'd)

III. SOLUTIONS PACKAGE DESCRIPTION (Cont'd)

(T)

(D)

(D)

M. Economy Pack Bundle

(M)(T)

Local Exchange Service

Caller ID with Name (includes Anonymous Call Rejection) - Optional

Call Waiting ID - Optional

Enhanced Call Waiting - Optional

N. Economy Pack Plus Bundle ^[1] ^[2]

(M)(T)

Local Exchange Service

Caller ID with Name (includes Anonymous Call Rejection) - Optional

Call Waiting ID - Optional

Enhanced Call Waiting - Optional

(M)

(M)

^[1] Effective April 12, 2019, Economy Pack Plus Bundle is grandfathered. Availability to current customers is limited to lines and features in service at existing locations. (T)

^[2] Customers must also subscribe to the Company's 768 Kbps High Speed Internet. (T)

(D)

(M) Monthly rates for Residence Solutions Packages moved to Page 2.9 of this section.

UNITED TELEPHONE COMPANY OF THE WEST d/b/a CenturyLink
NEBRASKA
GENERAL EXCHANGE PRICE LIST

SECTION 2
PAGE: 2.8
RELEASE: 5

ISSUED: October 9, 2020

EFFECTIVE: October 19, 2020

SPECIAL PACKAGED OFFERINGS

A. SOLUTIONS - RESIDENCE (Cont'd)

III. SOLUTIONS PACKAGE DESCRIPTION (Cont'd)

(T)

O. Home Phone II ^[1] – GRANDFATHERED ^[2]

(T)

Local Exchange Service
Anonymous Call Rejection
Repeat Dial
Call Forward Busy – Fixed
Call Forward No Answer – Fixed
Call Forwarding
Call Forward Remote Access (where available)
Return Call
Enhanced Call Waiting
Call Waiting ID
Caller ID with Name
Cancel Call Waiting
Message Waiting
Selective Call Acceptance
Selective Call Forwarding
Selective Call Rejection
Selective Call Ring
Three-Way Calling
Voice Mail (**Deregulated service**)

(T)

(M)

(M)

^[1] The customer must subscribe to either CenturyLink Communications, LLC Home Phone II Per Minute long distance plan or CenturyLink Communications, LLC Home Phone II Unlimited long distance plan to qualify for this bundle.

^[2] Effective June 11, 2017, Home Phone II is grandfathered. Availability to current customers is limited to lines in service at existing locations.

(D)

(M) Monthly rates for Residence Solutions Packages moved to Page 2.10 of this section.

UNITED TELEPHONE COMPANY OF THE WEST - NEBRASKA
GENERAL EXCHANGE
PRICE LIST

SECTION 2
PAGE: 2.9
RELEASE: 2

ISSUED: October 30, 2020

EFFECTIVE: January 29, 2021

SPECIAL PACKAGED OFFERINGS

A. SOLUTIONS - RESIDENCE (Cont'd)

IV. RATES

See section A.III preceding for Solutions Package descriptions.

Package Name	GF	Monthly Rate
Core Solution	✓	\$47.75 (l)
Personal II Solution	✓	45.00 (l)
Home II Solution	✓	44.50 (l)
Special Plan Bundle	✓	48.25
- Discounted with Embarq Communications, Inc. Solutions Unlimited - Option 1 long distance plan plus either the Company's High-speed Internet (DSL), DISH Network® Satellite TV from the Company or EMBARQ Wireless	✓	36.00 (l)
Progressive Plan	✓	36.50 (l)
Simple Solution	✓	31.00 (l)
Follow Me Plan	✓	37.00 (l)
Essential Home Phone Plan	✓	36.00 (l)
Pure Bundle ⁽¹⁾	✓	28.00
Simple Choice Bundle	✓	35.95 (l)
-with Voicemail and Embarq Communications, Inc. Easy Talk Simple Choice Long Distance	✓	28.00 (l)
Economy Pack Bundle ⁽¹⁾		33.95 (l)
-Customers who subscribe under a twelve-month commitment will receive a \$5.00 discount off the monthly rate during the first twelve months of service, after which the applicable monthly rate will apply.		
Economy Pack Plus Bundle	✓	31.00 (l)

GF (✓) = Grandfathered and limited to lines in service at existing locations for current customers.

⁽¹⁾ The monthly rate includes the interstate Subscriber Line Charge.

UNITED TELEPHONE COMPANY OF THE WEST - NEBRASKA
GENERAL EXCHANGE
PRICE LIST

SECTION 2
PAGE: 2.10
RELEASE: 1

ISSUED: October 9, 2020

EFFECTIVE: October 19, 2020

SPECIAL PACKAGED OFFERINGS

A. SOLUTIONS - RESIDENCE

IV. RATES (Cont'd)

See section A.III preceding for Solutions Package descriptions.

(N)

Package Name	GF	Monthly Rate ^[1]	
		"A" Exchanges	"B" Exchanges
Simple Choice Unlimited Bundle ^[2]	✓	29.95	39.95
Simple Choice Unlimited Bundle ^[2] with Embarq Communications, Inc. Easy Talk Simple Choice Long Distance and with subscription to:	✓		
- Voicemail		26.00	36.00
- High Speed Internet (1.5M or higher)		24.95	34.95
- Voicemail and High-Speed Internet (1.5M or higher)		21.00	31.00
Home Phone II	✓	28.95	38.95

(M) (T)

GF (✓) = Grandfathered and limited to lines in service at existing locations for current customers.

^[1] Exchanges are as follows:

A: Bayard, Chappell, Gering, Kimball, Lewellen, Lyman, Minatare, Mitchell, Morrill, Oshkosh, Scottsbluff

B: Exchanges: Broadwater and Potter

(M) Material moved from Pages 2.6 and 2.8 of this section.

(M) (T)

UNITED TELEPHONE COMPANY OF THE WEST - NEBRASKA
GENERAL EXCHANGE
PRICE LIST

SECTION 2
PAGE: 3
RELEASE: 12

ISSUED: September 20, 2010

EFFECTIVE: September 30, 2010

SPECIAL PACKAGED OFFERINGS

B. SOLUTIONS - BUSINESS

I. GENERAL

- A. Solutions is an optional business service enrollment plan that permits a customer to receive Flat Rate Business Individual Line Local Exchange Service plus features for a flat monthly rate, for each Solutions Package residence line provided.

II. REGULATIONS

- A. Solutions customers may terminate their enrollment in the Plan at any time upon notice to the Company.
- B. Unless terminated by the Solutions customer or the Company, a customer will remain enrolled in the Plan, as amended from time-to-time, with any applicable changes in rate, for as long as the Plan continues to be offered by the Company.
- C. This Plan is not available with Business ISDN-BRI Service lines, to customers who are or become toll restricted. Rotary Hunt Service is not available in conjunction with the Plan unless Rotary Line Service is included in a specific Solutions Package. The Plan cannot terminate to a Key system, PBX or any other line trunking device.
- D. No more than nine (9) business lines can be enrolled with the Solutions option(s) for each customer location or per account.
- E. Service Connection Charges do not apply when Solutions replaces existing Local Exchange Service or if the customer requests a change from Solutions back to regulated Local Exchange Service. Service Connection Charges as specified in Section 18 of the Company's General Exchange Tariff apply for new and additional Solutions lines and moves of existing Solutions lines, except for Pure Bundle lines. No Service Connection Charges apply for installation of Pure Bundle.
- F. Solutions customers are not eligible for promotional offerings associated with the Custom Calling Services included in this Plan, unless specifically provided for in a promotional offering.

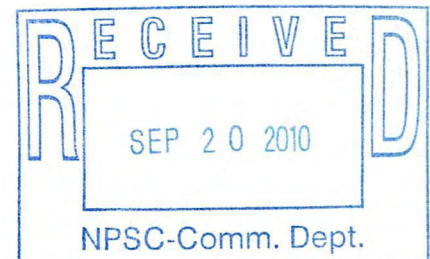

(D)

(D)

UNITED TELEPHONE COMPANY OF THE WEST - NEBRASKA d/b/a CENTURYLINK
GENERAL EXCHANGE
PRICE LIST

(C)

SECTION 2

PAGE: 3.1

RELEASE: 3

ISSUED: July 1, 2011

EFFECTIVE: July 15, 2011

SPECIAL PACKAGED OFFERINGS

B. SOLUTIONS - BUSINESS (Cont'd)

III. TERM DISCOUNT PLAN (TDP) ⁽¹⁾

(C)

A. General

- (1) A Term Discount Plan (TDP) provides business Solutions-Business customers who have two or more packages at the same location with discounted rates for the second and each additional package (up to a maximum of eight discounted packages at the same location) when the customers also subscribe to any Embarq Communications, Inc. long distance plan.
- (2) Only those Solutions business packages as specified in III.C.(2) are eligible for discounts under this Term Discount Plan. No discount applies on the initial business package subscribed to under this TDP.
- (3) Customers may subscribe to the same or different business packages under this TDP. However, the discount applies only on those additional packages for which the tariffed monthly rate is equal to or less than the monthly rate of the initial business package.
- (4) Customers must subscribe to a two-year TDP commitment period to receive the discount. At the end of the TDP commitment period the customer may renew the TDP for another two-year TDP commitment period. If the customer does not specify renewal terms in writing 90 days prior to the expiration of the TDP, the commitment period and the discount in effect at the time of expiration will automatically be extended for 12 months. The customer can terminate service at the end of the commitment period with no penalty or obligation to continue the service.
- (5) Rate increases or decreases will automatically be applied to the monthly term plan rates for the remaining term of the TDP. If a Company initiated rate increase causes the services under the TDP to increase by 10% or more annually, then the customer may cancel the TDP without incurring termination liability charges provided the customer notifies the Company within 30 days after the effective date of the rate increase.

⁽¹⁾ As of July 15, 2011, availability of Term Discount Plan is limited to lines in service for existing customers. (N)
(N)

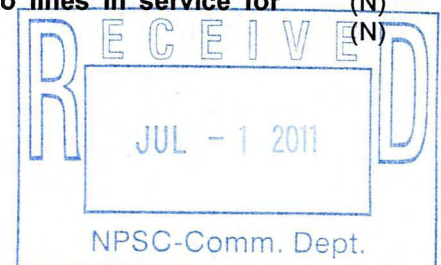

UNITED TELEPHONE COMPANY OF THE WEST - NEBRASKA d/b/a CENTURYLINK
GENERAL EXCHANGE
PRICE LIST

SECTION 2

PAGE: 3.2

RELEASE: 5

ISSUED: October 9, 2020

EFFECTIVE: October 19, 2020

SPECIAL PACKAGED OFFERINGS

B. SOLUTIONS - BUSINESS (Cont'd)

III. TERM DISCOUNT PLAN (TDP) (Cont'd) ⁽¹⁾

B. Termination Liability Charges

- (1) If a TDP customer disconnects any or all of the business packages subscribed to under the TDP, a termination liability charge will apply for the lines that are disconnected. The termination liability charge will be a one-time charge of \$50.00 per business package that is prematurely disconnected.
- (2) If a TDP customer retains the access line associated with a Solutions business package, but discontinues any or all of remaining features and services that are required to receive the TDP discount, no termination liability charges will apply. However, all discounts for which the customer was eligible under this TDP will cease as of the date the required service(s) and/or feature(s) is discontinued, and the monthly rate for the remaining access lines will default to the applicable tariffed monthly rate for business individual line service.

C. Discounts

- (1) Customers who subscribe to two or more of the business packages listed as follows will receive a 10% discount off the tariffed monthly rate for the second and each additional package at the same location. A maximum of eight packages are eligible for the discount.
- (2) Business packages eligible for the discount under this TDP are:

Sure Solution II
Priority Solution
Economy Solution

Economy Bundle II A

(D)

⁽¹⁾ As of July 15, 2011, availability of Term Discount Plan is limited to lines in service for existing customers.

UNITED TELEPHONE COMPANY OF THE WEST - NEBRASKA d/b/a CENTURYLINK
GENERAL EXCHANGE
PRICE LIST

SECTION 2

PAGE: 4

RELEASE: 24

ISSUED: October 9, 2020

EFFECTIVE: October 19, 2020

SPECIAL PACKAGED OFFERINGS

B. SOLUTIONS - BUSINESS (Cont'd)

IV. PACKAGE DESCRIPTION (Cont'd)

(T)

(D)

(D)

See Section B.V. for applicable Solutions Package rates.

(N)

A. Priority Solution – GRANDFATHERED ^[1]

(M)(T)

Local Exchange Service

Call Forwarding

Call Forward No Answer - Fixed

Call Forward Busy - Fixed

Enhanced Call Waiting

Caller ID with Name (includes Anonymous Call Rejection)

B. Sure Solution II – GRANDFATHERED ^[2]

(M)(T)

Local Exchange Service

Enhanced Call Waiting

Return Call

Three-Way Calling

Call Forwarding

Call Waiting ID

Repeat Dial Caller ID with Name (includes Anonymous Call Rejection)

Call Forward Busy - Fixed

Call Forward No Answer – Fixed

C. Reserved

(D)

^[1] Effective June 20, 2008, this service will no longer be available for new installations. As of July 15, 2011, this service is limited to lines in service for existing customers.

(T)

^[2] As of July 15, 2011, this service is limited to lines in service for existing customers.

(T)

(M) Monthly rates for Business Solutions Packages moved to Page 4.2.1 of this section.

(D)

UNITED TELEPHONE COMPANY OF THE WEST - NEBRASKA d/b/a CENTURYLINK
GENERAL EXCHANGE
PRICE LIST

SECTION 2
PAGE: 4.01
RELEASE: 10

ISSUED: October 9, 2020

EFFECTIVE: October 19, 2020

SPECIAL PACKAGED OFFERINGS

B. SOLUTIONS - BUSINESS (Cont'd)

IV. PACKAGE DESCRIPTION (Cont'd)

(T)

(D)

(D)

D. Preferred Solution – GRANDFATHERED ^[1]

(M)(T)

Local Exchange Service
Enhanced Call Waiting
Call Forwarding
Three-Way Calling
Call Forward Busy - Fixed
Call Forward No Answer – Fixed

E. Economy Solution – GRANDFATHERED ^[2]^[4]

(M)(T)

Local Exchange Service
Choice of two of the following:
Call Forward No Answer - Fixed plus Call Forward Busy - Fixed
Enhanced Call Waiting ^[3]
Caller ID with Name (includes Anonymous Call Rejection) ^[3]
Signal Ring

(T)

(T)

(D)

(D)

(T)

^[1] Effective June 16, 2005, this service will no longer be available for new installations. As of July 15, 2011, this service is limited to lines in service for existing customers.

^[2] Customers must also subscribe to any Embarq Communications, Inc. long distance plan.

(T)

^[3] When Enhanced Call Waiting and Caller ID with Name are the selected features, Call Waiting ID is also provided.

(T)

^[4] As of July 15, 2011, this service is limited to lines in service for existing customers.

(T)

(M) Monthly rates for Business Solutions Packages moved to Page 4.2.1 of this section.

UNITED TELEPHONE COMPANY OF THE WEST - NEBRASKA d/b/a CENTURYLINK
GENERAL EXCHANGE
PRICE LIST

SECTION 2
PAGE: 4.1
RELEASE: 18

ISSUED: October 9, 2020

EFFECTIVE: October 19, 2020

SPECIAL PACKAGED OFFERINGS

B. SOLUTIONS - BUSINESS (Cont'd)

IV. PACKAGE DESCRIPTION (Cont'd)

(T)

(D)

(D)

F. Economy Solution II ^[1] – **GRANDFATHERED** ^[2]

(M)(T)

Local Exchange Service

Choice of three of the following:

Call Forward No Answer - Fixed plus Call Forward Busy - Fixed

Enhanced Call Waiting ^[3]

(T)

Caller ID with Name (includes Anonymous Call Rejection) ^[3]

(T)

Three-Way Calling

Repeat Dial

G. Economy Bundle II A ^[1] – **GRANDFATHERED** ^[4]

(M)(T)

Local Exchange Service

Choice of three of the following:

Call Forward Busy – Fixed plus Call Forward No Answer - Fixed

Enhanced Call Waiting ^[3]

(T)

Caller ID with Name (includes Anonymous Call Rejection) ^[3]

(T)

Three-Way Calling

Return Call

(D)

(D)

^[1] Customers must also subscribe to any Embarq Communications, Inc. long distance plan.

(T)

^[2] Effective May 4, 2005, Economy Solution II will no longer be available for new installations. As of July 15, 2011 this service is limited to lines in service for existing customers.

(T)

^[3] When Enhanced Call Waiting and Caller ID with Name are the selected features, Call Waiting ID is also provided.

(T)

^[4] As of July 15, 2011 this service is limited to lines in service for existing customers.

(T)

(M) Monthly rates for Business Solutions Packages moved to Page 4.2.1 of this section.

UNITED TELEPHONE COMPANY OF THE WEST - NEBRASKA d/b/a CENTURYLINK
GENERAL EXCHANGE
PRICE LIST

SECTION 2
PAGE: 4.2
RELEASE: 17
EFFECTIVE: October 19, 2020

ISSUED: October 9, 2020

SPECIAL PACKAGED OFFERINGS

- B. SOLUTIONS - BUSINESS (Cont'd) (T)
- IV. PACKAGE DESCRIPTION (Cont'd) (T)
- H. Complete Business Bundle ^[1] – **GRANDFATHERED** ^[2] (M)(T)
- Local Exchange Service
 - Enhanced Call Waiting
 - Return Call
 - Three-Way Calling
 - Call Forwarding
 - Call Waiting ID
 - Repeat Dial
 - Caller ID with Name (includes Anonymous Call Rejection)
 - Call Forward Busy - Fixed
 - Call Forward No Answer - Fixed
- I. Pure Bundle (M)(T)
- Local Exchange Service
 - Outbound Call Block Feature
 - Non-Published Directory Listing
 - Billed Number Screening (optional)

[1] Customers must also subscribe to 1.5 Mbps (or greater) High-speed Internet under a two year (or greater) term commitment, Voice Mail, DSL Secure, and Embarq Communications, Inc. Small Business Unlimited Solutions II long distance plan. (D)
(D)
(T)

[2] As of July 15, 2011, this service is limited to lines in service for existing customers. (T)
(D)

(M) Monthly rates for Business Solutions Packages moved to Page 4.2.1 of this section.

UNITED TELEPHONE COMPANY OF THE WEST - NEBRASKA
GENERAL EXCHANGE
PRICE LIST

SECTION 2
PAGE: 4.2.1
RELEASE: 2

ISSUED: October 30, 2020

EFFECTIVE: January 29, 2021

SPECIAL PACKAGED OFFERINGS

B. SOLUTIONS - BUSINESS (Cont'd)

V. SOLUTIONS – BUSINESS

See section B.IV. preceding for Solutions Package descriptions.

Package Name	GF	Monthly Rate ⁽¹⁾
Priority Solution	✓	\$59.00 (l)
Sure Solution II	✓	62.00 (l)
Preferred Solution	✓	54.50 (l)
Economy Solution	✓	54.50 (l)
Economy Solution II	✓	54.50 (l)
Economy Bundle II A	✓	54.50 (l)
Complete Business Bundle	✓	62.00 (l)
Pure Bundle ⁽¹⁾		38.00

GF (✓) = Grandfathered and limited to lines in service at existing locations for current customers.

⁽¹⁾ The monthly rate includes the interstate Subscriber Line Charge.

UNITED TELEPHONE COMPANY OF THE WEST - NEBRASKA d/b/a CENTURYLINK
GENERAL EXCHANGE
PRICE LIST

(C)

SECTION 2
PAGE: 4.3
RELEASE: 3

ISSUED: July 1, 2011

EFFECTIVE: July 15, 2011

SPECIAL PACKAGED OFFERINGS

C. SOLUTIONS II – BUSINESS ⁽¹⁾

(C)

I. GENERAL

- A. Solutions II is an optional business service enrollment plan that permits a customer to receive business Local Exchange Service and additional features and services for a flat monthly rate for each Solutions II business line.

II. REGULATIONS

- A. Solutions II customers may terminate their enrollment in the plan at any time upon notice to the Company.
- B. Unless terminated by the Solutions II customer or the Company, a customer will remain enrolled in the Plan, as amended from time-to-time, with any applicable changes in rate, for as long as the Plan continues to be offered by the Company.
- C. The Plan is not available with Centrex Service II, Business ISDN-BRI Service lines, Payphone Line Service, or PBX Trunks.
- D. The Plan is not available to customers who are or become toll restricted. Service Connection Charges will not apply for those existing lines converted, in-place, to business exchange service due to company-initiated toll restrictions. Such customers will not be permitted to re-enroll in this Plan until such time as all associated unpaid balances are satisfactorily paid in full.
- E. No more than nine (9) business lines can be enrolled with the Solutions II option(s) for each customer location or per account, except as specified following. There is no per location or per account limit on the number of business lines that can be enrolled with Basic Offer Bundle.
- F. Service Connection Charges, as described in Section 18 of the General Exchange Tariff, apply to requests for new and additional Solutions II lines, and for moves of existing lines.
- G. Service Connection Charges do not apply when:
- Solutions II replaces existing Local Exchange Service or;
 - Customers request a change from Solutions II back to Local Exchange Service.
- H. Solutions II customers are not eligible for promotional offerings associated with the Custom Calling Features and ExpressTouch Services included in the Plan, unless specifically provided for in a promotional offering.

⁽¹⁾ As of July 15, 2011 this service is limited to lines in service for existing customers.

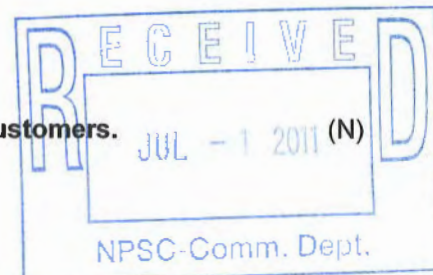

UNITED TELEPHONE COMPANY OF THE WEST - NEBRASKA d/b/a CENTURYLINK
GENERAL EXCHANGE
PRICE LIST

(C)

SECTION 2
PAGE: 4.4
RELEASE: 2

ISSUED: July 1, 2011

EFFECTIVE: July 15, 2011

SPECIAL PACKAGED OFFERINGS

C. SOLUTIONS II – BUSINESS (Cont'd) ⁽¹⁾

(C)

II. REGULATIONS (Cont'd)

- I. Service Connection Charges will not apply for those existing lines converted, in-place, to business exchange service due to company-initiated toll restrictions. In addition, any optional services not affected by the toll restriction will convert to their applicable tariff rates. Such customers will not be permitted to re-enroll in this Plan until such time as all associated unpaid balances are satisfactorily paid in full.
- J. Prices of the individual services included in these packages may be higher or lower than the packaged offering. These packages are available for as long as the customer retains all of the required services. If a customer discontinues any of the services that are required to be eligible for a package, the non-discounted rates for each remaining individual service that was part of the packaged offering will apply.

⁽¹⁾ As of July 15, 2011 this service is limited to lines in service for existing customers.

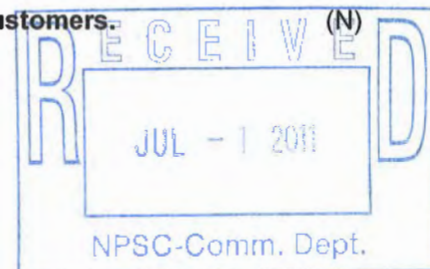

UNITED TELEPHONE COMPANY OF THE WEST - NEBRASKA d/b/a CENTURYLINK
GENERAL EXCHANGE
PRICE LIST

(C)

SECTION 2
PAGE: 4.5
RELEASE: 2

ISSUED: July 1, 2011

EFFECTIVE: July 15, 2011

SPECIAL PACKAGED OFFERINGS

C. SOLUTIONS II – BUSINESS (Cont'd) ⁽¹⁾

(C)

III. TERM DISCOUNT PLAN (TDP)

- A. Solutions II is available under a Term Discount Plan (TDP) for term commitments of one, two or three years. At the end of the TDP commitment period the customer may renew the TDP one, two or three year TDP commitment period. If the customer does not specify renewal terms in writing 90 days prior to the expiration of the TDP, the commitment period and the monthly rate in effect at the time of expiration will automatically be extended for 12 months. The customer can terminate service at the end of the commitment period with no penalty or obligation to continue the service.
- B. Rate increases or decreases will automatically be applied to the monthly term commitment rates for the remaining term of the TDP. If a Company initiated rate increase causes the services under the TDP to increase by 10% or more annually, then the customer may cancel the TDP without incurring termination liability charges provided the customer notifies the Company within 30 days after the effective date of the rate increase.
- C. For Complete Business Bundle II, if a customer disconnects any of the access lines prior to the expiration of the TDP, there will be no termination liability charges applicable to regulated services. A termination liability charge is only applicable should the customer also disconnects the Company's non-regulated High-speed Internet when originally purchased as an accompanying qualifier service prior to the expiration of the associated TDP.

For Connected II and Economy Bundle II B, if a customer disconnects any of the access lines prior to the expiration of the TDP, a termination liability charge will apply for the disconnected access line(s). The termination liability charge will be a one-time charge of \$50.00 for each access line associated with Connected II and/or Economy Bundle II B that is prematurely disconnected.

- D. If a customer retains the access line(s) associated with a Solutions II business package, but discontinues any or all of the associated regulated features and services, no termination liability charges will apply. However, all discounts for which the customer was eligible under this TDP will cease as of the date the service(s) and/or feature(s) are discontinued, and the monthly rate for the access lines(s) will default to the applicable tariffed monthly rates.

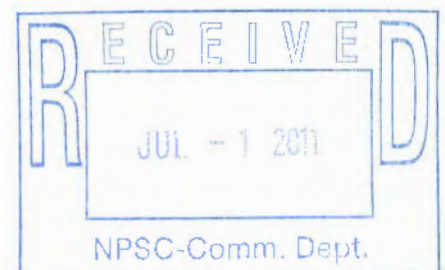

⁽¹⁾ As of July 15, 2011 this service is limited to lines in service for existing customers.

(N)

UNITED TELEPHONE COMPANY OF THE WEST - NEBRASKA d/b/a CENTURYLINK
 GENERAL EXCHANGE
 PRICE LIST

SECTION 2
 PAGE: 4.6
 RELEASE: 9

ISSUED: October 30, 2020

EFFECTIVE: January 29, 2021

SPECIAL PACKAGED OFFERINGS

C. SOLUTIONS II – BUSINESS (Cont'd) ⁽³⁾

IV. RATES AND CHARGES

A. Connected II ^{(1) (3)}

Key Trunk or Business Individual Line Service
 Rotary Hunt Service (optional)
 Enhanced Call Waiting
 Three-Way Calling or Three-Way Calling with Transfer
 Call Forwarding
 Return Call
 Repeat Dial
 Speed Dial 8
 Caller ID with Name (includes
 Anonymous Call Rejection)
 Call Forward No Answer-Fixed
 Call Forward Busy-Fixed
 Call Waiting ID

Monthly Rates ⁽²⁾				
	Month-to- Month, per bundle	Term Commitments		
		1 Year, per bundle	2 Years, per bundle	3 Years, per bundle
All Exchanges	\$61.00 (l)	\$61.00 (l)	\$61.00 (l)	\$61.00 (l)

- (1) Customers must also subscribe to Embarq Communications, Inc. Small Business Unlimited Solutions II long distance plan (Option 2 – Extended Calling USA).
- (2) The Solutions monthly rate and the applicable EAS Additive monthly rate will appear as a single item on the customer's bill.
- (3) As of July 15, 2011 this service is limited to lines in service for existing customers.

UNITED TELEPHONE COMPANY OF THE WEST - NEBRASKA d/b/a CENTURYLINK
 GENERAL EXCHANGE
 PRICE LIST

SECTION 2
 PAGE: 4.7
 RELEASE: 8

ISSUED: October 30, 2020

EFFECTIVE: January 29, 2021

SPECIAL PACKAGED OFFERINGS

C. SOLUTIONS II – BUSINESS (Cont'd) ⁽⁴⁾

IV. RATES AND CHARGES (Cont'd)

B. Economy Bundle II B ^{(1) (4)}

Business Individual Line Service

Choice of three of the following:

Call Forward No Answer - Fixed
 plus Call Forward Busy - Fixed

Enhanced Call Waiting ⁽³⁾

Caller ID with Name (includes
 Anonymous Call Rejection) ⁽³⁾

Three-Way Calling

Return Call

Monthly Rates ⁽²⁾				
	Month-to-Month, per bundle	Term Commitments		
		1 Year, per bundle	2 Years, per bundle	3 Years, per bundle
All Exchanges	\$54.50 (1)	\$54.50 (1)	\$54.50 (1)	\$54.50 (1)

(1) Customers must also subscribe to an Embarq Communications, Inc. long distance plan.

(2) The Solutions monthly rate and the applicable EAS Additive monthly rate will appear as a single item on the customer's bill.

(3) When Enhanced Call Waiting and Caller ID with Name are the selected features, Call Waiting ID is also provided.

(4) As of July 15, 2011 this service is limited to lines in service for existing customers.

UNITED TELEPHONE COMPANY OF THE WEST - NEBRASKA d/b/a CENTURYLINK
 GENERAL EXCHANGE
 PRICE LIST

SECTION 2
 PAGE: 4.8
 RELEASE: 8

ISSUED: October 30, 2020

EFFECTIVE: January 29, 2021

SPECIAL PACKAGED OFFERINGS

C. SOLUTIONS II – BUSINESS (Cont'd)

IV. RATES AND CHARGES (Cont'd)

C. Complete Business Bundle II ^{(1) (3)}

- Key Trunk or Business Individual Line Service
- Rotary Hunt Service (optional)
- Enhanced Call Waiting
- Three-Way Calling or Three-Way Calling with Transfer
- Call Forwarding
- Return Call
- Repeat Dial
- Speed Dial 8
- Caller ID with Name (includes Anonymous Call Rejection)
- Call Waiting ID
- Call Forward No Answer-Fixed
- Call Forward Busy-Fixed

Monthly Rates ⁽²⁾				
	Month-to-Month, per bundle	Term Commitments		
		1 Year, per bundle	2 Years, per bundle	3 Years, per bundle
All Exchanges	\$50.00 (l)	\$50.00 (l)	\$50.00 (l)	\$50.00 (l)

- (1) Customers must also subscribe to Embarq Communications, Inc. Small Business Unlimited Solutions II long distance plan (Option 2 – Extended Calling USA). In addition, customers must also subscribe to 1.5 Mbps (or greater) High-speed Internet.
- (2) The Solutions monthly rate and the applicable EAS Additive monthly rate will appear as a single item on the customer's bill.
- (3) As of July 15, 2011, this service is limited to lines in service for existing customers.

UNITED TELEPHONE COMPANY OF THE WEST - NEBRASKA d/b/a CENTURYLINK
GENERAL EXCHANGE
PRICE LIST

SECTION 2

PAGE: 4.9

RELEASE: 5

ISSUED: September 17, 2018

EFFECTIVE: October 1, 2018

SPECIAL PACKAGED OFFERINGS

C. SOLUTIONS II – BUSINESS (Cont'd) ⁽³⁾

IV. RATES AND CHARGES (Cont'd)

D. Reserved

(C)

(D)

NE 18-07

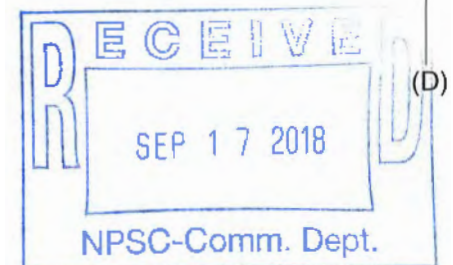

UNITED TELEPHONE COMPANY OF THE WEST d/b/a CENTURYLINK
NEBRASKA
GENERAL EXCHANGE PRICE LIST

SECTION 2
PAGE: 5
RELEASE: 3
EFFECTIVE: June 1, 2021

ISSUED: May 20, 2021

SPECIAL PACKAGED OFFERINGS

C. CENTREX SERVICE II

Equipment used in conjunction with Dial Switching Systems and connected to the Company's network on or after February 16, 2020, must, upon connection to the Company's facilities, be configured by the Customer or equipment manufacturer to allow direct "911" dialing by any end user and must be configured to send MLTS notifications as described in the Multi-Line Telephone Systems section under General Rules and Regulations Applying to Telephone Service.

Equipment connected as described preceding must also be configured such that it is capable of conveying the dispatchable location of a "911" caller as described in the Multi-Line Telephone Systems section under General Rules and Regulations Applying to Telephone Service. (N)

I. GENERAL

Centrex Service II is a central office communications system package provided on individual access lines from Company central office equipment. The service provides local exchange access, interexchange access, intrasystem communication, and Centrex Service II feature packages. Customers subscribing to Centrex Service II with 26 or more Centrex Service II access lines may subscribe to Centrex Service II under an Individual Case Basis (ICB) contract.

II. DEFINITIONS

ABBREVIATED DIALING

Allows station abbreviated dialing (i.e., 3, 4, or 5 digit dialing) to other station members within the same customer group.

AUTO ANSWER BACK

Allows any incoming call to the Primary Directory Number of the set to be automatically answered after four seconds.

AUTOMATIC CALL DISTRIBUTION (ACD)

Automatic Call Distribution is a digital central office service that provides advanced call distribution and queuing capabilities as an integrated function of Centrex Service II. The customer must subscribe to and maintain a minimum of two ACD positions and at least one ACD group.

AUTOMATIC LINE

Provides an automatic connection between a calling station that goes off-hook and a predetermined terminating number.

CALL FORWARD - UNIVERSAL, BUSY, AND NO ANSWER

Allows a customer to have incoming calls to a station automatically forwarded to a predetermined telephone number, either on all calls and/or busy calls and/or calls not answered.

NE 2021 10

Received by NPSC
05/19/2021

UNITED TELEPHONE COMPANY OF THE WEST d/b/a CENTURYLINK
GENERAL EXCHANGE
PRICE LIST

SECTION 2
PAGE: 6
RELEASE: 3

ISSUED: September 10, 2020

EFFECTIVE: September 21, 2020

SPECIAL PACKAGED OFFERINGS

C. CENTREX SERVICE II (Cont'd)

II. DEFINITIONS (Cont'd)

CALL HOLD

Allows the station user to hold one call for any length of time provided neither party hangs up. The station user may also place other calls while a call is on hold.

CALL PARK

Allows the station user to park one call against its own directory number. The parked call can be retrieved from any station within the same customer group. Once a call is parked against a directory number, the user is free to make or receive calls on that directory number.

CALL PICK-UP

Allows the station user to answer incoming calls directed to another station within a defined pick-up group by dialing a feature activation code.

CALL TRANSFER

Allows a station to transfer an incoming call to another extension.

CALL WAITING - CANCEL CALL WAITING

Informs a station user, while on an established call, that a second call is waiting. Cancel Call Waiting allows a station user to prevent, on a per-call basis, any incoming calls from call-waiting on his or her line. Incoming calls to the station are given busy treatment. This feature ensures that call-waiting indication tones will not interrupt important calls or disrupt data transmissions.

CLASS OF SERVICE RESTRICTIONS ^[1]

(C)

Defines the specific features and calling patterns available to stations and attendants within a customer group. Access code restrictions can be set up to restrict stations and attendants from trunk types such as local, toll, and DID. The following options are available:

Fully Restricted Service – Allows intragroup dialing only. The station user must dial 9

Toll Restricted Service – Allows intragroup and local dialing only. The station user must dial 9

Unrestricted Service – Allows full access to all facilities. The station user must dial 9

Unrestricted Assume Dial 9 – Same as unrestricted; however, the station user cannot utilize abbreviated dialing

Note: 900 and 976 block are available with all options.

^[1] **Class of Service Restrictions configured on and after February 16, 2020 must be configured to allow end users to dial "911" directly without dialing "9" or any other prefix code prior to dialing "911" as described in Section 23.A.1**

(N)
|
(N)

UNITED TELEPHONE COMPANY OF THE WEST - NEBRASKA
GENERAL EXCHANGE
PRICE LIST

SECTION 2
PAGE: 7
RELEASE: 2

ISSUED: September 10, 2020

EFFECTIVE: September 21, 2020

SPECIAL PACKAGED OFFERINGS

C. CENTREX SERVICE II (Cont'd)

II. DEFINITIONS (Cont'd)

DIRECT INWARD DIALING

Allows for incoming calls from the exchange network to reach a specific station. The calling party dials the seven-digit directory number to reach the station.

DIRECT OUTWARD DIALING ^[1]

(C)

Allows a station user to place external calls to the exchange network by dialing the access code (usually the digit 9), receiving an optional second dial tone, then dialing the external number.

DISTINCTIVE RINGING

Provides the station user the ability to determine whether the call is from a station within the customer group or from the exchange network by the cadence of the ringing of the phone. The ringing cadence will be one (1) long ring for internal calls and two (2) short rings for external calls.

LAST NUMBER REDIAL

Enables the station user to redial the last called number by pressing a single key rather than dialing the entire number.

MEET-ME CONFERENCE

Allows up to six (6) conferees to hold a conference call by dialing a directory number at a specified time. Meet-Me-Conference is limited to one (1) per Centrex Service II access line.

MULTIPLE APPEARANCE-DIRECTORY NUMBER (MADN)

A directory number that is assigned to more than one station.

MUSIC-ON-HOLD

Provides the music-on-hold capability to calls that terminate on business sets. When a call is put on hold, the caller hears music, announcement, silence, or a combination of the three treatments. The music source must be provided by the subscriber and requires an additional Centrex Service II access line connecting the customer's music source to the Company's central office.

^[1] **DIRECT OUTWARD DIALING is grandfathered effective February 16, 2020.**

(N)

UNITED TELEPHONE COMPANY OF THE WEST - NEBRASKA
GENERAL EXCHANGE
PRICE LIST

SECTION 2

PAGE: 8

RELEASE: 1

ISSUED: September 19, 2003

EFFECTIVE: October 1, 2003

SPECIAL PACKAGED OFFERINGS

C. CENTREX SERVICE II (Cont'd)

II. DEFINITIONS (Cont'd)

RING AGAIN

Allows a station user encountering a busy station to be notified when the busy station becomes idle and to be placed automatically in a ring-again mode.

SECONDARY DIRECTORY NUMBER

Directory number not associated with a line, but assigned for use with priority hunting. Secondary Directory Numbers are limited to two (2) per Centrex Service II access line.

SPEED CALL LONG (30)

Provides for the calling of up to 30 numbers by dialing an abbreviated code.

SPEED CALL SHORT (10)

Provides for the calling of up to 10 numbers by dialing an abbreviated code.

STATION HUNTING (sequential, circular, multiline)

Allows a call to be routed to another telephone number when the called station is busy.

THREE-WAY CONFERENCE WITH CONSULTATION HOLD AND TRANSFER

Allows a station user to call a third party to conference the third party in, notify the third party of a call being transferred or consult with the third party while the other party is on hold.

TOUCH-TONE

A central office provided tone network signaling arrangement for origination of telephone calling.

UNIFORM CALL DISTRIBUTION (UCD)

Allows for an even distribution of incoming calls to a listed directory number. Each station has its own directory number. Included with this feature is the provision of message announcement for calls in queuing. The customer will be responsible for providing the compatible tape and the announcement.

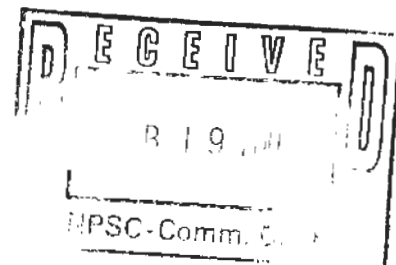

UNITED TELEPHONE COMPANY OF THE WEST - NEBRASKA
GENERAL EXCHANGE
PRICE LIST

SECTION 2

PAGE: 9

RELEASE: 1

ISSUED: September 19, 2003

EFFECTIVE: October 1, 2003

SPECIAL PACKAGED OFFERINGS

C. CENTREX SERVICE II (Cont'd)

III. REGULATIONS

- A. Centrex Service II is provided subject to the availability of facilities and central office equipment as determined by the Company.
- B. Centrex Service II does not include terminal equipment on the customer's premises. Provision of the telephone instruments or other equipment is the responsibility of the customer. Some features require specific customer provided customer premises equipment (CPE). In addition, not all CPE will support all features.
- C. Directory Listings are furnished in accordance with the rates and regulations specified in Section 4 of the General Exchange Tariff.
- D. Service Connection Charges as specified in Section 18 of the General Exchange Tariff apply to the services offered in this section and are in addition to the Service Establishment Translation Charge. For feature changes after the initial installation, the Service Order Charge will apply in addition to applicable nonrecurring charges.
- E. The minimum service period for Centrex Service II is one month, unless customers select a 1 year or 3 year TDP.
- F. The quality of transmission for calls utilizing call forwarding or conferencing may vary depending on the distance and routing involved.
- G. Directory Assistance charges, as specified in Section 32 of the General Exchange Tariff, apply to Centrex Service II.
- H. Call Forward-Universal, Busy, and No Answer shall not be used to extend calls on a planned and continuing basis to intentionally avoid the payment in whole or in part of message toll charges that would regularly be applicable between the station originating the call and the station to which the call is transferred nor shall it be used to simulate rotary service from the Company central office. Each Centrex Service II access line allows for the forwarding of one call at a given time.

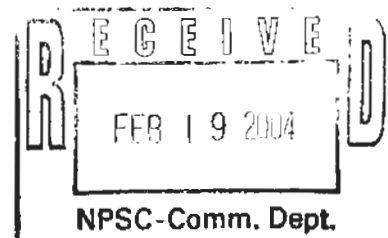

UNITED TELEPHONE COMPANY OF THE WEST - NEBRASKA
GENERAL EXCHANGE
PRICE LIST

SECTION 2

PAGE: 10

RELEASE: 2

ISSUED: June 23, 2005

EFFECTIVE: July 3, 2005

SPECIAL PACKAGED OFFERINGS

C. CENTREX SERVICE II (Cont'd)

III. REGULATIONS (Cont'd)

- I. Suspension of Service at request of subscribers, as specified in Section 20 of the General Exchange Tariff, is not allowed for Centrex Service II.
- J. Not all Centrex Service II features are compatible with one another. Some combinations of features will not work when applied on the same Centrex Service II access line.
- K. Centrex Service II is not offered in conjunction with key or PBX systems.
- L. The assignment of telephone numbers and the sequence of the numbers assigned to a Centrex Service II are made at the discretion of the Company. The Company does not guarantee to provide telephone numbers arranged in a consecutive manner. If the customer requests telephone numbers under a special numbering arrangement to be terminated in a Centrex Service II customer group, then additional recurring and non-recurring charges may apply as determined under an ICB arrangement.
- M. Centrex Service II is not provided in association with Local Measured Service, residential lines, or Payphone Line Service.
- N. All exchange access lines terminating in a Centrex Service II system must be served by the same central office or associated remote switch.
- O. The rates and charges applicable to Extended Area Service (EAS), as specified in the Local Exchange Tariff also apply per Centrex Service II access line **and will be included with the Centrex Service II Access Line as a single item on the customer's bill.**
- P. The Company shall not be liable, directly or indirectly for damages, unless caused by gross negligence of the Company in failing to maintain reasonable standards of maintenance and inspection and exercise reasonable supervision.

(C)
|
(C)

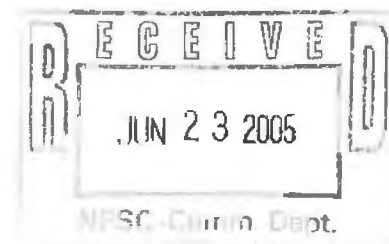

UNITED TELEPHONE COMPANY OF THE WEST - NEBRASKA
GENERAL EXCHANGE
PRICE LIST

SECTION 2

PAGE: 11

RELEASE: 1

ISSUED: September 19, 2003

EFFECTIVE: October 1, 2003

SPECIAL PACKAGED OFFERINGS

C. CENTREX SERVICE II (Cont'd)

IV. SERVICE FEATURES

A. Standard Features

The Centrex Service II access line rate includes the following features, however the customer may select which features are activated on a per line basis.

Abbreviated Dialing
Auto Answer Back
Call Forward - Universal, Busy, and No Answer
Call Hold
Call Transfer
Call Waiting - Cancel Call Waiting
Direct Inward Dialing
Direct Outward Dialing
Last Number Redial
Speed Call Short (10)
Station Hunting
Three-Way Conference with Consultation Hold and Transfer
Touch-Tone Service

B. Optional Features

The following optional features are available at the monthly rate specified in Section 2.C.VI.E.

Automatic Call Distribution
Automatic Line
Call Park/Call Pick-Up
Class-of-Service Restrictions
Distinctive Ringing/Ring Again
Meet-Me-Conference
Multiple Appearance Directory Number (MADN)
Music On-Hold
Secondary Directory Number
Speed Call Long (30)
Uniform Call Distribution

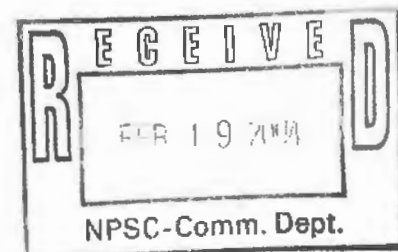

UNITED TELEPHONE COMPANY OF THE WEST - NEBRASKA
GENERAL EXCHANGE
PRICE LIST

SECTION 2
PAGE: 12
RELEASE: 1

ISSUED: September 19, 2003

EFFECTIVE: October 1, 2003

SPECIAL PACKAGED OFFERINGS

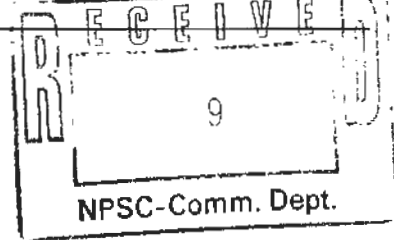

C. CENTREX SERVICE II (Cont'd)

V. TERM DISCOUNT PLAN (TDP)

- A. Term Discount Plans (TDPs) are available for Centrex Service II, and provide the customer with discounted rates. The customer must agree to a minimum service commitment period for Centrex Service II when the TDP is established. The customer must order a TDP in writing to the Company. A TDP may be ordered based on the following plan options:

Plan A: 1 Year
Plan B: 3 Year

- B. The customer must specify the length of the initial service period at the time the service is ordered. When a customer converts to a TDP, no Service Establishment Translation Charge is applied toward Centrex Service II facilities in-service at that time. If a customer moves from a month to month plan to a TDP, or upgrades from a 1 year TDP to a 3 year TDP, then no Service Establishment Translation Charge is applied.
- C. If a TDP customer disconnects service prior to the end of the TDP, the customer is liable for 100% of the payments remaining for the remainder of the term plan. If Construction and Installation Charges were applied to the service being terminated, any termination charges associated with those services will also apply.
- D. Rate increases or decreases will automatically be applied to the monthly term plan rates for the remaining term of the TDP. If Company initiated rate increases to any rate element or combination of rate elements causes the charges for the entire Centrex Service II under the TDP to increase by 10% or more annually, then the customer may cancel the TDP without incurring termination liability charges provided that the customer notifies the Company within 30 days after the effective date of the rate increase.
- E. TDP commitment periods can be extended by the customer at any time during the term of the plan, up to a maximum of 3 years. The number of months accrued in the current plan will apply toward the new plan selected. However, charges under the new TDP commitment period will apply only on a go-forward basis.
- F. Upon expiration of the TDP service commitment period, the customer may subscribe to a new TDP at the prevailing rates set forth in Section 2.C.VI.A. following. At the end of the TDP service commitment period there is no automatic renewal of the TDP, and the rates will convert to the prevailing month to month rates unless the customer selects a new TDP.
- G. Customers under a TDP who change physical locations will not be subject to termination charges if the customer subscribes to a new Centrex Service II TDP at the new location. However, the number of months accrued in the current plan will not apply toward the plan selected for the new location.

UNITED TELEPHONE COMPANY OF THE WEST - NEBRASKA d/b/a CENTURYLINK
GENERAL EXCHANGE
PRICE LIST

(C)

SECTION 2
PAGE: 13
RELEASE: 3
EFFECTIVE: April 8, 2013

ISSUED: March 29, 2013

SPECIAL PACKAGED OFFERINGS

C. CENTREX SERVICE II (Cont'd)

VI. RATES AND CHARGES

A. Business, Centrex Service II Access Line

Monthly Rate

Month to Month	\$34.00
1 Year	32.00
3 Year	30.00

B. Service Establishment Translation Charge

Nonrecurring
Charge

\$50.00

1. This charge applies when performing the central office translation associated with configuring a Centrex Service II customer's network parameters.
2. This charge applies to each Centrex Service II customer group translation activity performed.
3. Service Connection Charges as specified in Section 18 of the General Exchange Tariff apply to the services offered in this section and are in addition to the Service Establishment Translation Charge.

C. Feature Change Charge

Nonrecurring
Charge

- | | |
|--------------------------|---------|
| 1. Per line | \$10.00 |
| Maximum charge per order | 50.00 |
2. This charge applies when performing changes to service features after the initial installation. This charge applies to both standard features and optional features.
 3. For feature changes after the initial installation, a Service Order Charge will also apply.

D. Federal monthly end user charges apply on a per line basis, as described in **CenturyLink Operating Companies Tariff F.C.C. No. 9, Section 4.**

(T)

MAR 28 2013

UNITED TELEPHONE COMPANY OF THE WEST - NEBRASKA
GENERAL EXCHANGE
PRICE LIST

SECTION 2
PAGE: 14
RELEASE: 2

ISSUED: December 30, 2008

EFFECTIVE: January 9, 2009

SPECIAL PACKAGED OFFERINGS

C. CENTREX SERVICE II (Cont'd)

VI. RATES AND CHARGES (Cont'd)

	<u>Monthly Rate</u>
E. Optional Features	
Automatic Call Distribution	ICB
Automatic Line	\$ 2.00
Call Park/Call Pick-Up	2.00
Class-of-Service Restrictions	2.20 <i>Was \$ 2.00 (1)</i>
Distinctive Ringing/Ring Again	2.00
Meet-Me-Conference (per customer group)	20.25
Multiple Appearance Directory Number (per number, per appearance)	3.00
Music On-Hold (per customer group)	25.00
Secondary Directory Number (per directory number)	3.00
Speed Call Long (30) (per customer group)	5.00
Uniform Call Distribution	ICB

UNITED TELEPHONE COMPANY OF THE WEST - NEBRASKA d/b/a CENTURYLINK
GENERAL EXCHANGE
PRICE LIST

(C)

SECTION 2
PAGE: 15
RELEASE: 5

ISSUED: July 1, 2011

EFFECTIVE: July 15, 2011

SPECIAL PACKAGED OFFERINGS

D. CONNECTION CENTRAL BUNDLE ⁽¹⁾

(C)

I. GENERAL

A. Connection Central Bundle is an optional business service enrollment plan that permits a customer to receive features and services for a flat monthly rate for each bundle provided. Connection Central Bundle includes the following features and services:

1. Local Exchange Service
2. Rotary Hunt Service - optional
3. Three-Way Conferencing with Option to Transfer
4. Caller ID with Name (includes Anonymous Call Rejection)
5. Enhanced Call Waiting - optional
6. Call Waiting ID - optional

II. REGULATIONS

- A. The Plan is not available with Business Flat Rate Local Exchange Service, Centrex, ISDN Service lines, Payphone Line Service lines, or PBX Trunks.
- B. The Plan is not available to customers who are or become toll restricted. Service Connection Charges will not apply for those existing lines converted, in-place, to business exchange service due to company-initiated toll restrictions. Such customers will not be permitted to re-enroll in this Plan until such time as all associated unpaid balances are satisfactorily paid in full.
- C. Customers may subscribe to a maximum of two Connection Central Bundles per location which must be billed under a single bill.
- D. Service Connection Charges do not apply when:
 1. A Connection Central Bundle replaces existing Local Exchange Service;
 2. Customers request a change from a Connection Central Bundle back to regulated Local Exchange Service; or
 3. New and additional Connection Central Bundle lines are added.

⁽¹⁾ As of July 15, 2011 this service is limited to lines in service for existing customers.

(N)

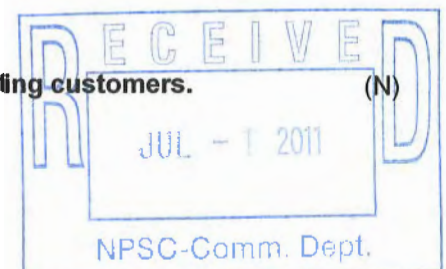

UNITED TELEPHONE COMPANY OF THE WEST - NEBRASKA d/b/a CENTURYLINK
GENERAL EXCHANGE
PRICE LIST

(C)

SECTION 2
PAGE: 16
RELEASE: 3

ISSUED: July 1, 2011

EFFECTIVE: July 15, 2011

SPECIAL PACKAGED OFFERINGS

D. CONNECTION CENTRAL BUNDLE (Cont'd) ⁽⁴⁾

(C)

III. TERM DISCOUNT PLAN (TDP)

- A. Connection Central Bundle is available under a Term Discount Plan (TDP) for term commitments of one or two years. At the end of the TDP commitment period the customer may renew the TDP for another one or two year TDP commitment period. If the customer does not specify renewal terms in writing 90 days prior to the expiration of the TDP, the commitment period and the discount in effect at the time of expiration will automatically be extended for 12 months. The customer can terminate service at the end of the commitment period with no penalty or obligation to continue the service.
- B. Rate increases or decreases will automatically be applied to the monthly term commitment rates for the remaining term of the TDP. If a Company initiated rate increase causes the services under the TDP to increase by 10% or more annually, then the customer may cancel the TDP without incurring termination liability charges provided the customer notifies the Company within 30 days after the effective date of the rate increase.
- C. If customers disconnect one or both of the access lines associated with Connection Central Bundle prior to the expiration of the TDP, a termination liability charge will apply for the disconnected line(s). The termination liability charge will be a one-time charge equal to the sum of 50% of the payments that would apply for the remainder of the TDP.
- D. If a customer retains the access line(s) associated with Connection Central Bundle, but discontinues any or all of the associated features and services, no termination liability charges will apply. However, all discounts for which the customer was eligible under this TDP will cease as of the date the service(s) and/or feature(s) are discontinued, and the monthly rate for the access lines(s) will default to the applicable tariffed monthly rates.

IV. RATES AND CHARGES

	Monthly Rate ⁽¹⁾
A. One Year Commitment Period, per bundle	\$40.00 ^{(2) (3)}
B. Two Year Commitment Period, per bundle	40.00 ^{(2) (3)}

⁽¹⁾ The EAS Additive is included in this monthly rate.

⁽²⁾ Initial bundle - Customers must also subscribe to 1.5 Mbps (or greater) High-speed Internet under a one or two year term commitment, DSL Secure, Embarq Communications, Inc. Small Business Unlimited Solutions II long distance plan, and must purchase the Company's non-regulated Connection Central CPE.

⁽³⁾ Second bundle - Customers must also subscribe to Embarq Communications, Inc. Small Business Unlimited Solutions II long distance plan.

⁽⁴⁾ As of July 15, 2011 this service is limited to lines in service for existing customers.

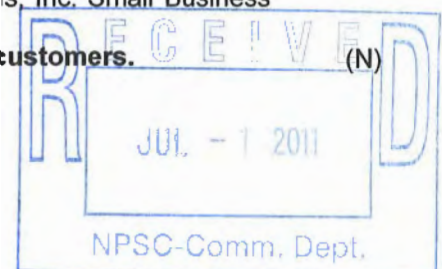

UNITED TELEPHONE COMPANY OF THE WEST - NEBRASKA d/b/a CENTURYLINK
GENERAL EXCHANGE
PRICE LIST

SECTION 2
PAGE: 17
RELEASE: 3
EFFECTIVE: 01-10-13

ISSUED: 12-28-12

SPECIAL PACKAGED OFFERINGS

E. PRIMARY RATE INTERFACE (PRI) **BUNDLE** (T)

I. GENERAL

A. PRI Bundle is an optional business service enrollment plan. This offering permits a customer to receive features and services for a flat monthly rate for each bundle provided. PRI Bundle includes the following features and services:

1. **ISDN-PRI Business Service consisting of 2-Way Primary Rate Interface and 24 Primary Rate Channels** (T)
(T)
(D)
(D)
2. Up to 100 Direct Inward Dialing (DID) Numbers (in blocks of 20) - Optional (T)
3. ISDN-PRI **Business Service** Standard Features (T)
4. Incoming Call Identification (Caller ID Name and Number) (T)



UNITED TELEPHONE COMPANY OF THE WEST - NEBRASKA
GENERAL EXCHANGE
PRICE LIST

SECTION 2
PAGE: 17.4
RELEASE: 1

ISSUED: November 17, 2006

EFFECTIVE: November 27, 2006

SPECIAL PACKAGED OFFERINGS

E. PRIMARY RATE INTERFACE (PRI) BUNDLE – BUSINESS

I. GENERAL

- A. PRI Bundle is an optional business service enrollment plan. This offering permits a customer to receive features and services for a flat monthly rate for each bundle provided. PRI Bundle includes the following features and services:
1. Primary Rate Access Line (Intraexchange)
 2. Primary Rate Interface (Two-Way)
 3. Primary Rate Channels (24 Channels)
 4. Up to 100 Direct Inward Dialing (DID) Numbers (in blocks of 20) - Optional
 5. ISDN-PRI Standard Features
 6. Incoming Call Identification (Caller ID Name and Number)
- B. Customers must subscribe to any Embarq Communications, Inc. long distance plan at the rates applicable for that service.

UNITED TELEPHONE COMPANY OF THE WEST - NEBRASKA d/b/a CENTURYLINK
GENERAL EXCHANGE
PRICE LIST

SECTION 2
PAGE: 18
RELEASE: 2
EFFECTIVE: 01-10-13

ISSUED: 12-28-12

SPECIAL PACKAGED OFFERINGS

E. PRIMARY RATE INTERFACE (PRI) **BUNDLE** (Cont'd) (T)

II. REGULATIONS

- A. Unless specified otherwise in this section, the regulations for ISDN-PRI **Business Service**, including Service Connection Charges, set forth in the General Exchange Price List Section 1, apply in addition to the regulations herein. (T)
- B. Unless specified otherwise in this section, the regulations for DID Service, including Non-recurring and Installation Charges, set forth in the General Exchange Price List Section 11, apply in addition to the regulations herein.
- C. Service Connection Charges do not apply when PRI Bundle replaces existing Local Exchange Service.
- D. Customers may activate all 100 DID numbers included in the bundle rate concurrent with installation of service or may activate the numbers in blocks of 20. When a customer activates fewer than 100 numbers concurrent with establishment of service, Service Connection Charges do not apply for the initial or subsequent activations of 10-number blocks (up to 100 numbers).
- E. Customers may order additional DID numbers, in excess of 100 for an individual PRI Bundle, subject to availability, at the rates specified in Section 11 of this Price List. Non-recurring and Installation Charges apply for subsequent activation of numbers beyond those included in the bundle.
- F. The Optional Features available for ISDN-PRI **Business Service** are available with PRI Bundle at the rates specified in the General Exchange Price List Section 1. (T)
- G. PRI Bundle is available under the term commitments of 2 years, 3 years, and 5 years. Termination Liability Charges set forth in the General Exchange Price List Section 1 apply for PRI Bundle.

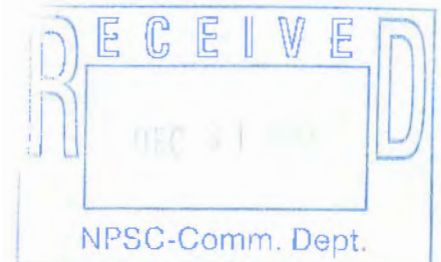

UNITED TELEPHONE COMPANY OF THE WEST - NEBRASKA
GENERAL EXCHANGE
PRICE LIST

SECTION 2
PAGE: 18, 1
RELEASE: 1

ISSUED: November 17, 2006

EFFECTIVE: November 27, 2006

SPECIAL PACKAGED OFFERINGS

E. PRIMARY RATE INTERFACE (PRI) BUNDLE – BUSINESS (Cont'd)

II. REGULATIONS

- A. Unless specified otherwise in this section, the regulations for ISDN-PRI Service, including Service Connection Charges, set forth in the General Exchange Price List Section 1, apply in addition to the regulations herein.
- B. Unless specified otherwise in this section, the regulations for DID Service, including Non-recurring and Installation Charges, set forth in the General Exchange Price List Section 11, apply in addition to the regulations herein.
- C. Service Connection Charges do not apply when PRI Bundle replaces existing Local Exchange Service.
- D. Customers may activate all 100 DID numbers included in the bundle rate concurrent with installation of service or may activate the numbers in blocks of 20. When a customer activates fewer than 100 numbers concurrent with establishment of service, Service Connection Charges do not apply for the initial or subsequent activations of 10-number blocks (up to 100 numbers).
- E. Customers may order additional DID numbers, in excess of 100 for an individual PRI Bundle, subject to availability, at the rates specified in Section 11 of this Price List. Non-recurring and Installation Charges apply for subsequent activation of numbers beyond those included in the bundle.
- F. The Optional Features available for ISDN-PRI Service are available with PRI Bundle at the rates specified in the General Exchange Price List Section 1.
- G. PRI Bundle is available under the term commitments of 2 years, 3 years, and 5 years. Termination Liability Charges set forth in the General Exchange Price List Section 1 apply for PRI Bundle.

UNITED TELEPHONE COMPANY OF THE WEST - NEBRASKA
 GENERAL EXCHANGE
 PRICE LIST

SECTION 2
 PAGE: 19
 RELEASE: 2
 EFFECTIVE: 01-10-13

ISSUED: 12-28-12

SPECIAL PACKAGED OFFERINGS

E. PRIMARY RATE INTERFACE (PRI) **BUNDLE** (Cont'd) (T)

II. REGULATIONS (Cont'd)

- H. Unless terminated by the PRI Bundle customer or the Company, a customer will remain enrolled in the PRI Bundle, as amended from time to time, with any applicable changes in rate, for as long as the PRI Bundle continues to be offered by the Company. If any features or services in the bundle are discontinued by the customer, the remaining features and services will be charged the normal tariff rate or charge.
- I. Customers enrolled in the bundle, who subsequently become subject to Company initiated toll restriction will have all existing PRI Bundle lines converted to the applicable tariff rates. Service Connection Charges will not apply for those existing lines converted, in-place, due to termination procedures. In addition, any optional services not affected by the termination procedures will convert to their applicable tariff rates. Such customers will not be permitted to re-enroll in this bundle until such time as all associated unpaid balances are satisfactorily paid in full.

III. RATES AND CHARGES

		<u>Monthly Rates</u>		
		<u>Rate Groups</u>	<u>Rate</u>	<u>Nonrecurring</u>
		<u>1 and 2</u>	<u>Group 3</u>	<u>Charge</u>
A.	Term Commitment			
	2 years	\$962.90	\$537.90	\$ 0.00
	3 years	922.90	532.90	0.00
	5 years	862.90	527.90	0.00

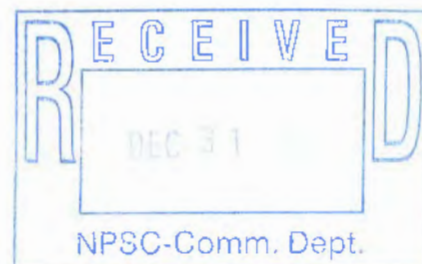

UNITED TELEPHONE COMPANY OF THE WEST - NEBRASKA d/b/a CENTURYLINK
GENERAL EXCHANGE
PRICE LIST

(C)

SECTION 2
PAGE: 20
RELEASE: 4

ISSUED: July 1, 2011

EFFECTIVE: July 15, 2011

SPECIAL PACKAGED OFFERINGS

F. MULTILINE BUNDLE ⁽¹⁾

(C)

I. GENERAL

- A. MultiLine Bundle is an optional business service enrollment plan that permits customers to receive Local Exchange Service and additional features and services for a flat monthly rate, for each MultiLine Bundle provided. Customers must subscribe to at least two MultiLine Bundles per location, which must be billed under a single invoice.

II. REGULATIONS

- A. The Plan is not available with Centrex, ISDN Service lines, Payphone Line Service lines, or PBX Trunks.
- B. The Plan is not available to customers who are or become toll restricted. Service Connection Charges will not apply for those existing lines converted, in-place, to business exchange service due to company-initiated toll restrictions. Such customers will not be permitted to re-enroll in this Plan until such time as all associated unpaid balances are satisfactorily paid in full.
- C. Service Connection Charges as specified in Section 18 of this tariff apply for new and additional MultiLine Bundles and moves of existing MultiLine Bundles.
- D. Service Connection Charges do not apply when a MultiLine Bundle replaces existing Local Exchange Service.

⁽¹⁾ As of July 15, 2011 this service is limited to lines in service for existing customers.

(N)

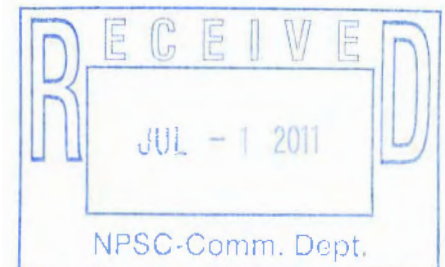

UNITED TELEPHONE COMPANY OF THE WEST - NEBRASKA d/b/a CENTURYLINK
GENERAL EXCHANGE
PRICE LIST

(C)

SECTION 2
PAGE: 21
RELEASE: 5

ISSUED: July 1, 2011

EFFECTIVE: July 15, 2011

SPECIAL PACKAGED OFFERINGS

F. MULTILINE BUNDLE (Cont'd) ⁽¹⁾

(C)

III. TERM DISCOUNT PLAN (TDP)

- A. MultiLine Bundle is available under a Term Discount Plan (TDP) for term commitments of one, two or three years. At the end of the TDP commitment period the customer may renew the TDP for another one, two or three year TDP commitment period. If the customer does not specify renewal terms in writing 90 days prior to the expiration of the TDP, the commitment period and the discount in effect at the time of expiration will automatically be extended for 12 months. The customer can terminate service at the end of the commitment period with no penalty or obligation to continue the service.
- B. Rate increases or decreases will automatically be applied to the monthly term commitment rates for the remaining term of the TDP. If a Company initiated rate increase causes the services under the TDP to increase by 10% or more annually, then the customer may cancel the TDP without incurring termination liability charges provided the customer notifies the Company within 30 days after the effective date of the rate increase.
- C. If a customer disconnects any of the access lines associated with MultiLine Bundle prior to the expiration of the TDP, there will be no termination liability charges applicable to MultiLine Bundle regulated services. A termination liability charge is only applicable should the customer also disconnect required non-regulated companion service(s).
- D. Customers must retain a minimum of two MultiLine Bundles. If disconnection of any access line associated MultiLine Bundle(s) prior to the end of the TDP results in only one remaining MultiLine Bundle, that remaining bundle will default to the applicable tariffed rates for the Local Exchange Service access line or key trunk, including Rotary Hunt Service if the line or trunk is so equipped, plus the tariffed rates for the individual features.
- E. If a customer retains the access line(s) associated with MultiLine Bundle, but discontinues any or all of the required regulated services then associated access line(s) will default to the applicable tariffed rates for the Local Exchange Service access line or key trunk, including Rotary Hunt Service if the line or trunk is so equipped, plus the tariffed rates for the individual features.

⁽¹⁾ As of July 15, 2011 this service is limited to lines in service for existing customers.

(N)

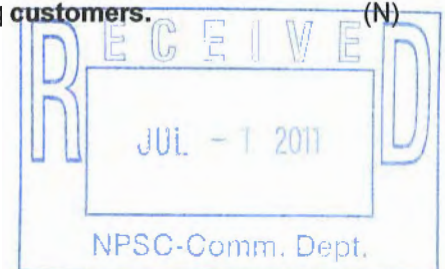

UNITED TELEPHONE COMPANY OF THE WEST - NEBRASKA d/b/a CENTURYLINK
GENERAL EXCHANGE
PRICE LIST

SECTION 2

PAGE: 22

RELEASE: 9

ISSUED: October 30, 2020

EFFECTIVE: January 29, 2021

SPECIAL PACKAGED OFFERINGS

F. MULTILINE BUNDLE (Cont'd) ⁽³⁾

IV. RATES AND CHARGES

Each MultiLine Bundle includes the following:

Key Trunk or Business Flat Rate Service
Rotary Hunt Service - optional
Three-Way Calling with Option to Transfer - optional
Caller ID with Name (includes Anonymous Call Rejection) - optional

	Monthly Rates ⁽¹⁾
A. Month-to-Month, per bundle	\$50.00 ⁽²⁾ (1)
B. One Year Commitment Period, per bundle	50.00 ⁽²⁾ (1)
C. Two Year Commitment Period, per bundle	50.00 ⁽²⁾ (1)
D. Three Year Commitment Period, per bundle	45.00 ⁽²⁾ (1)

⁽¹⁾ The MultiLine Bundle monthly rate and the applicable EAS Additive monthly rate will appear as a single item on the customer's bill.

⁽²⁾ In addition to subscribing to an Embarq Communications, Inc. long distance plan for each MultiLine Bundle, customers must also subscribe to one of the following qualifying services per MultiLine Bundle location:

- 1) the Company's non-regulated 1.5 Mbps (where available) or greater High-speed Internet. (In locations where the 1.5 Mbps is not available, customers may alternatively subscribe to the Company's 768 Kbps High-speed Internet or non-regulated Satellite Broadband Service); or;
- 2) the Company's non-regulated Dedicated IP Service.

The qualifying service must be billed on the same invoice as the MultiLine Bundles, but may be provisioned on access lines or trunks other than the MultiLine Bundle that are billed under the same invoice.

⁽³⁾ As of July 15, 2011, this service is limited to lines in service for existing customers.

UNITED TELEPHONE COMPANY OF THE WEST - NEBRASKA
GENERAL EXCHANGE
PRICE LIST

SECTION 2
PAGE: 23
RELEASE: 1

ISSUED: September 12, 2008

EFFECTIVE: September 22, 2008

SPECIAL PACKAGED OFFERINGS

G. HOSTED MULTILINE BUNDLE

I. GENERAL

A. Hosted MultiLine Bundle is an optional business service enrollment plan that permits customers to receive Local Exchange Service and additional features and services for a flat monthly rate, for each Hosted MultiLine Bundle provided. Each Hosted MultiLine Bundle includes one Centrex Service II access line. Customers must subscribe to a minimum of two and a maximum of nine Hosted MultiLine Bundles per location, which must be billed under a single invoice. Each Hosted MultiLine Bundle includes:

1. Centrex Service II access line
2. Centrex Service II Standard Features (see Section 2.C)
3. Caller ID with Name (includes Anonymous Call Rejection)
4. Call Waiting ID
5. Return Call
6. Distinctive Ringing/Ring Again
7. Call Park/Call Pick-Up
8. Multiple Appearance Directory Number (MADN)

II. REGULATIONS

- A. The Plan is provided subject to the availability of facilities and central office equipment as determined by the Company.
- B. The Plan is not available for lines that terminate into Key or PBX systems. Customers must purchase the Company's non-regulated Meridian M6320 digital set (CPE) for each Hosted MultiLine Bundle.
- C. Directory Listings are furnished in accordance with the rates and regulations specified in Section 4 of the General Exchange Tariff.
- D. The Plan is not available to customers who are or become toll restricted. Service Connection Charges will not apply for those existing lines converted, in-place, to business exchange service due to company-initiated toll restrictions. Such customers will not be permitted to re-enroll in this Plan until such time as all associated unpaid balances are satisfactorily paid in full.
- E. Service Connection Charges do not apply when:
1. A Hosted MultiLine Bundle replaces existing Local Exchange Service;
 2. Customers request a change from a Hosted MultiLine Bundle back to regulated Local Exchange Service; or
 3. New and additional Hosted MultiLine Bundle lines are added.

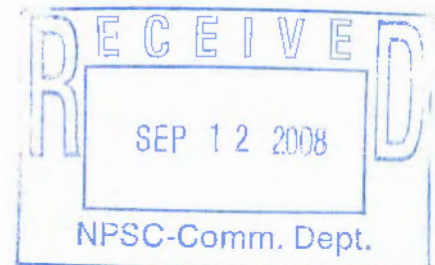

UNITED TELEPHONE COMPANY OF THE WEST - NEBRASKA
GENERAL EXCHANGE
PRICE LIST

SECTION 2
PAGE: 24
RELEASE: 1

ISSUED: September 12, 2008

EFFECTIVE: September 22, 2008

SPECIAL PACKAGED OFFERINGS

G. HOSTED MULTILINE BUNDLE (Continued)

II. REGULATIONS (Continued)

- F. The quality of transmission for calls utilizing call forwarding or conferencing may vary depending on the distance and routing involved.
- G. Directory Assistance charges, as specified in Section 30 of the General Exchange Tariff, apply to Hosted MultiLine Bundle.
- H. Call Forward features shall not be used to extend calls on a planned and continuing basis to intentionally avoid the payment in whole or in part of message toll charges that would regularly be applicable between the station originating the call and the station to which the call is transferred nor shall it be used to simulate rotary service from the Company central office. Only one call forwarding arrangement, consisting of a single calling path, may be provided per Hosted MultiLine Bundle for which the customer subscribes to a Call Forward feature.
- I. Suspension of Service at Request of Subscribers, as specified in Section 20 of the General Exchange Tariff, is not allowed for Hosted MultiLine Bundle.
- J. The assignment of telephone numbers and the sequence of the numbers assigned to a Hosted MultiLine Bundle are made at the discretion of the Company. The Company does not guarantee to provide telephone numbers arranged in a consecutive manner. If the customer requests telephone numbers under a special numbering arrangement to be terminated in a Hosted MultiLine Bundle customer group, then additional recurring and non-recurring charges may apply as determined under an ICB arrangement.
- K. The Company shall not be liable, directly or indirectly for damages, unless caused by gross negligence of the Company in failing to maintain reasonable standards of maintenance and inspection and exercise reasonable supervision.

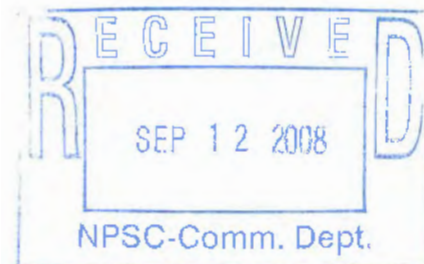

UNITED TELEPHONE COMPANY OF THE WEST - NEBRASKA
GENERAL EXCHANGE
PRICE LIST

SECTION 2
PAGE: 25
RELEASE: 1

ISSUED: September 12, 2008

EFFECTIVE: September 22, 2008

SPECIAL PACKAGED OFFERINGS

G. HOSTED MULTILINE BUNDLE (Continued)

III. TERM DISCOUNT PLAN (TDP)

- A. Hosted MultiLine Bundle is available under a Term Discount Plan (TDP) for term commitments of one or three years. At the end of the TDP commitment period the customer may renew the TDP for another one or three year TDP commitment period. If the customer does not specify renewal terms in writing 90 days prior to the expiration of the TDP, the commitment period and the discount in effect at the time of expiration will automatically be extended for 12 months. The customer can terminate service at the end of the commitment period with no penalty or obligation to continue the service.
- B. Rate increases or decreases will automatically be applied to the monthly term commitment rates for the remaining term of the TDP. If a Company initiated rate increase causes the services under the TDP to increase by 10% or more annually, then the customer may cancel the TDP without incurring termination liability charges provided the customer notifies the Company within 30 days after the effective date of the rate increase.
- C. If a customer disconnects any or all of the access lines associated with Hosted MultiLine Bundle prior to the expiration of the TDP, a termination liability charge will apply for the disconnected access line(s). The termination liability charge will be a one-time charge equal to the sum of 50% of the remaining payments that would apply for the remainder of the TDP.
- D. Customers must retain a minimum of two Hosted MultiLine Bundles. If disconnection of any access line associated Hosted MultiLine Bundle(s) prior to the end of the TDP results in only one remaining Hosted MultiLine Bundle, that remaining bundle will default to the applicable tariffed rates for the Local Exchange Service access line, including Rotary Hunt Service if the line is so equipped, plus the tariffed rates for the individual features.
- E. If a customer retains the access line(s) associated with Hosted MultiLine Bundle, but discontinues any or all of the required services prior to the expiration of the TDP, the termination liability charge will be a one-time charge of \$100.00 for each Hosted MultiLine Bundle for which the required services were discontinued, and the associated access line(s) will default to the applicable tariffed rates for the Local Exchange Service access line, including Rotary Hunt Service if the line is so equipped, plus the tariffed rates for the individual features.

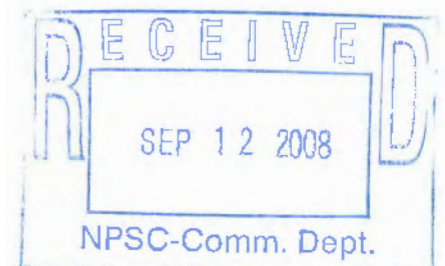

UNITED TELEPHONE COMPANY OF THE WEST - NEBRASKA
GENERAL EXCHANGE
PRICE LIST

SECTION 2
PAGE: 26
RELEASE: 1

ISSUED: September 12, 2008

EFFECTIVE: September 22, 2008

SPECIAL PACKAGED OFFERINGS

G. HOSTED MULTILINE BUNDLE (Continued)

IV. RATES AND CHARGES

A. Monthly Recurring Charges

Monthly Rate⁽¹⁾

One Year Commitment Period, per bundle
Three Year Commitment Period, per bundle

\$32.00⁽²⁾
30.00⁽²⁾

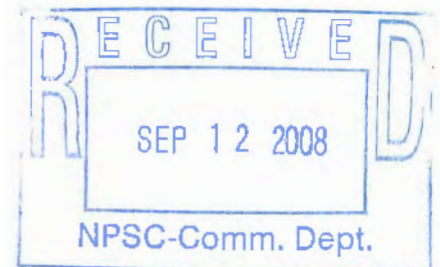

- ⁽¹⁾ The Hosted MultiLine Bundle monthly rate and the applicable EAS Additive monthly rate will appear as a single item on the customer's bill.
- ⁽²⁾ Customer must also subscribe to an Embarq Communications, Inc. long distance plan per bundle and the Company's non-regulated Elite Voicemail per bundle.

UNITED TELEPHONE COMPANY OF THE WEST - NEBRASKA d/b/a CENTURYLINK
GENERAL EXCHANGE
PRICE LIST

SECTION 2
PAGE: 27
RELEASE: 1

ISSUED: July 1, 2011

EFFECTIVE: July 15, 2011

SPECIAL PACKAGED OFFERINGS

H. BUSINESS ASSIST ADVANTAGE PLANS

I. GENERAL

Business Assist Advantage Plans are optional business service enrollment plans that permit customers to receive flat rated Local Exchange Service plus features and services for a flat monthly rate, for each Business Assist Advantage Plan business line provided.

II. REGULATIONS

- A. Business Assist Advantage Plan customers may terminate their enrollment in the plan at any time upon notice to the Company.
- B. Unless terminated by the Business Assist Advantage Plan customer or the Company, a customer will remain enrolled in the plan, as amended from time-to-time, with any applicable changes in rate, for as long as the plan continues to be offered by the Company.
- C. The plan is not available with Business ISDN-BRI Service lines, Payphone Line Service, to customers who are or become toll restricted. Rotary Line Service, as defined in Section 13, is not available in conjunction with the Plan unless Rotary Line Service is included in a specific Business Assist Advantage Plan Package. The Plan cannot terminate to a PBX or any other line trunking device, unless indicated for a specific Business Assist Advantage Plan Package.
- D. A customer may subscribe to a maximum of ten (10) Business Assist Advantage Plan business lines for each customer location, except as specified following. There is no per location limit on the number of business lines that can be enrolled with Business Assist Basic Plan or Business Assist Basic Plan Plus.
- E. Service Connection Charges, as described in Section 18 of this tariff, apply for new and additional Business Assist Advantage Plan lines, and moves of existing lines.
- F. Service Charges do not apply when Business Assist Advantage Plan replaces existing Local Exchange Service. Service Connection charges do apply when Customers request a change from a Business Assist Advantage Plan option back to Local Exchange Service.
- G. Business Assist Advantage Plan customers are not eligible for promotional offerings associated with the Custom Calling Services and/or ExpressTouch features included in the plan, unless specifically provided for in a promotional offering.
- H. Service Charges will not apply for those existing lines converted, in-place, to business exchange service due to company-initiated toll restrictions. In addition, any optional services not affected by the toll restriction will convert to their applicable tariff rates. Such customers will not be permitted to re-enroll in this Plan until such time as all associated unpaid balances are satisfactorily paid in full.

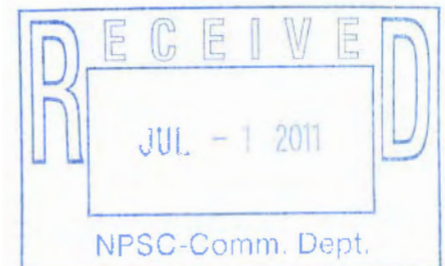

UNITED TELEPHONE COMPANY OF THE WEST - NEBRASKA d/b/a CENTURYLINK
GENERAL EXCHANGE
PRICE LIST

SECTION 2

PAGE: 28

RELEASE: 1

ISSUED: July 1, 2011

EFFECTIVE: July 15, 2011

SPECIAL PACKAGED OFFERINGS

H. BUSINESS ASSIST ADVANTAGE PLANS (Cont'd)

II. REGULATIONS (Cont'd)

- I. Prices of the individual services included in the Business Assist Advantage Plan may be higher or lower than the packaged offering. Business Assist Advantage Plan is available for as long as the customer retains all of the required services. If a Customer discontinues any of the services that are required to be eligible for the Plan, the non-discounted rates for each remaining individual service that was part of the packaged offering will apply.

III. TERM DISCOUNT PLAN (TDP)

A. General

1. A Term Discount Plan (TDP) provides Business Assist Advantage Plan customers with discounted rates when the customer(s) subscribe to a one, two or three-year TDP.
2. Rate increases or decreases will automatically be applied to the monthly term plan rates for the remaining term of the TDP. If a Company initiated rate increase causes the services under the TDP to increase by 10% or more annually, then the customer may cancel the TDP without incurring termination liability charges provided the customer notifies the Company within 30 days after the effective date of the rate increase.

B. Termination Liability Charges

If a customer who subscribes to a Business Assist Advantage Plan discontinues service prior to the end of the commitment period, there will be no termination liability charges applicable for the regulated portion(s) of the Business Assist Advantage Plan.

C. Discounts

The following discount applies for each occurrence of the monthly recurring charges applicable for the service to which the customer is subscribed. Usage charges are not discounted. The discount applies for the initial and each additional bundle at the same location.

<u>One Year</u>	<u>Two Years</u>	<u>Three Years</u>
10%	15%	20%

Upon expiration of the customer's TDP, the discount will expire and the customer will be charged at the prevailing monthly rates unless the customer renews or signs up for a new TDP.

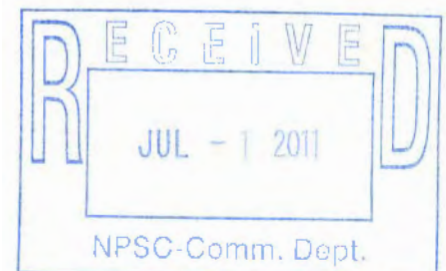

UNITED TELEPHONE COMPANY OF THE WEST - NEBRASKA d/b/a CENTURYLINK
GENERAL EXCHANGE
PRICE LIST

SECTION 2
PAGE: 29
RELEASE: 5

ISSUED: October 30, 2020

EFFECTIVE: January 29, 2021

SPECIAL PACKAGED OFFERINGS

H. BUSINESS ASSIST ADVANTAGE PLANS (Cont'd)

IV. RATES AND CHARGES

A. Business Assist Advantage Plan

Business Individual Line Service or Key Trunk
Rotary Hunt Service (optional)
Choice of available Custom Calling and/or ExpressTouch Features

	Monthly Rates
Initial bundle, per location ⁽¹⁾	\$55.00 (I)
2 nd through 10 th bundle (per bundle), per location	55.00 (I)

B. Unlimited Business Assist Advantage Plan ⁽²⁾

Business Individual Line Service or Key Trunk
Rotary Hunt Service (optional)
Choice of available Custom Calling and/or ExpressTouch Features

	Monthly Rates
Initial bundle, per location ⁽¹⁾	61.00 (I)
2 nd through 10 th bundle (per bundle), per location	47.00 (I)

⁽¹⁾ When customers also subscribe to the Company's non-regulated Voicemail, a \$2.50 discount is applied to the monthly rate.

⁽²⁾ Customers must also subscribe to Embarq Communications, Inc. long distance Business Unlimited, a Business Assist Advantage Plan.

UNITED TELEPHONE COMPANY OF THE WEST - NEBRASKA d/b/a CENTURYLINK
GENERAL EXCHANGE
PRICE LIST

SECTION 2
PAGE: 30
RELEASE: 2

ISSUED: October 10, 2017

EFFECTIVE: October 20, 2017

SPECIAL PACKAGED OFFERINGS

I. RESERVED

(C)

(D)

(D)

Received

OCT 11 2017

NPSC Comm. Dept.

UNITED TELEPHONE COMPANY OF THE WEST - NEBRASKA d/b/a CENTURYLINK
GENERAL EXCHANGE
PRICE LIST

SECTION 2

PAGE: 31

RELEASE: 2

ISSUED: October 10, 2017

EFFECTIVE: October 20, 2017

SPECIAL PACKAGED OFFERINGS

I. RESERVED (Cont'd)

(C)

(D)

(D)

NE17-08

Received

OCT 11 2017

NPSC Comm. Dept.

UNITED TELEPHONE COMPANY OF THE WEST - NEBRASKA d/b/a CENTURYLINK
GENERAL EXCHANGE PRICE LIST

SECTION 2

PAGE: 32

RELEASE: 3

ISSUED: April 17, 2014

EFFECTIVE: April 29, 2014

SPECIAL EXCHANGE SERVICES

J. CORE CONNECT

I. Description

A. CORE CONNECT is an optional enrollment plan that permits business customers who subscribe to qualifying products and services to receive Local Exchange Service and additional features and services for a flat monthly rate. (T)

B. CORE CONNECT bundles are available under a one-year, two-year or three-year term plans and are available on a month-to-month basis as specified in V. following. (T)

(T)

(M)

(M)

II. Regulations

(M1)

A. CORE CONNECT customers must also subscribe to the Company's non-regulated 1.5 Mbps or greater High-speed Internet at each CORE CONNECT location. In locations where 1.5 Mbps is not available, customers may alternatively subscribe to the Company's non-regulated 512 or 768 Kbps HSI. These qualifying services must be billed on the same invoice as CORE CONNECT, but may be provisioned on access lines or trunks other than CORE CONNECT. (T)

(T)

(M1)

(M2)

(M2)

(M) Material now appears on Page No. 37.

(M1) Material previously appeared on Page No. 33.

(M2) Material now appears on Page No. 36.

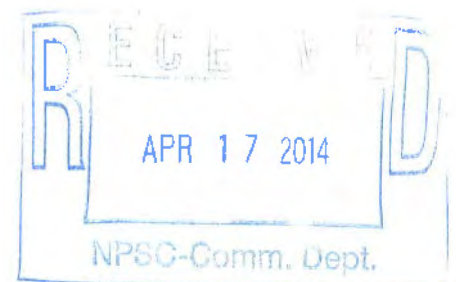

UNITED TELEPHONE COMPANY OF THE WEST - NEBRASKA d/b/a CENTURYLINK
GENERAL EXCHANGE PRICE LIST

SECTION 2
PAGE: 32.1
RELEASE: 2

ISSUED: April 17, 2014

EFFECTIVE: April 29, 2014

SPECIAL EXCHANGE SERVICES

J CORE CONNECT (Cont'd)

(M)

(M)

II. Regulations (Cont'd)

(M1)

- B. Customers may subscribe to a maximum of ten (10) CORE CONNECT business lines at each customer location.
- C. There is no minimum service period for CORE CONNECT. Customers who discontinue services within thirty days after establishment of service will be charged only for the number of days CORE CONNECT was in service. **Early termination liability charges for customers who subscribe to CORE CONNECT under a Term Discount Plan are as specified in III. following.**

(N)(M1)

(N)

(M)

(M) Material now appears on Page No. 37.

(M1) Material previously appeared on Page No. 33.

NE 14-03

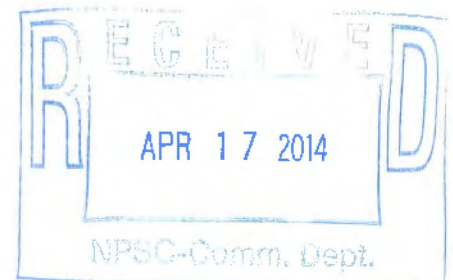

UNITED TELEPHONE COMPANY OF THE WEST - NEBRASKA d/b/a CENTURYLINK
GENERAL EXCHANGE PRICE LIST

SECTION 2

PAGE: 33

RELEASE: 3

ISSUED: April 17, 2014

EFFECTIVE: April 29, 2014

SPECIAL EXCHANGE SERVICES

J. CORE CONNECT (Cont'd)

II. Regulations (Cont'd)

(T)

(M)

(M)

(M1)

(M1)

(M2)

(M2)

- D. CORE CONNECT lines cannot terminate into a PBX or other line trunking device except as otherwise indicated herein.
- E. Components of CORE CONNECT will be converted to ala carte rates for the remaining services if customers remove any of the qualifying services.
- F. All terms and conditions specified elsewhere for the respective services/features requested as part of this plan shall apply.
- G. Services selected as part of this plan can only be provided where technically available and compatible with other services the customer may choose to order.
- H. CORE CONNECT cannot be combined with any other discounts unless otherwise specified.
- I. This plan is not available to customers who are or become toll restricted. Service Connection Charges will not apply for those existing lines converted, in-place, to business exchange service due to company-initiated toll restrictions. Such customers will not be permitted to re-enroll in this plan until such time as all associated unpaid balances are satisfactorily paid in full.

(M) Material now appears on Page No. 36.

(M1) Material now appears on Page No. 32.

(M2) Material now appears on Page No. 32.1.

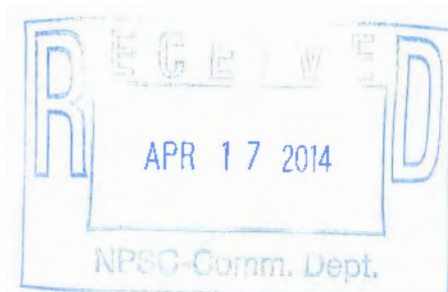

UNITED TELEPHONE COMPANY OF THE WEST - NEBRASKA d/b/a CENTURYLINK
GENERAL EXCHANGE PRICE LIST

SECTION 2

PAGE: 34

RELEASE: 2

ISSUED: April 17, 2014

EFFECTIVE: April 29, 2014

SPECIAL EXCHANGE SERVICES

J. CORE CONNECT (Cont'd)

III. Term Discount Plan

- A. A Term Discount Plan (TDP) provides customers with discounts when the customer subscribes to CORE CONNECT under a one, two or three-year term agreement.
- B. Any CORE CONNECT line(s) added subsequent to establishment of a TDP must be added under a separate TDP commitment period.
- C. The rates and discounts in effect when customers subscribe to CORE CONNECT under a TDP will apply until expiration of that TDP. CORE CONNECT lines that are subsequently added under a separate TDP will receive the tariffed **rates in effect** when those lines are added. (T)
- D. Upon expiration of a TDP, the TDP discounts specified in V. following will expire, and the customer will be charged at the then prevailing monthly rate. If the customer renews the TDP or signs up for a new TDP, the tariffed **rates then in effect** will apply for the new or renewed TDP. (T)
- E. If the Company terminates service for cause or if the customer discontinues the service in whole or in part without cause prior to the expiration date, no termination liability charges will apply for the regulated portion(s) of CORE CONNECT. However, if customers remove any of the qualifying services prior to the TDP expiration date, the remaining components of CORE CONNECT will be converted to ala carte rates and the TDP discount will not apply. (T)



UNITED TELEPHONE COMPANY OF THE WEST - NEBRASKA d/b/a CENTURYLINK
GENERAL EXCHANGE PRICE LIST

SECTION 2

PAGE: 35

RELEASE: 3

ISSUED: April 17, 2014

EFFECTIVE: April 29, 2014

SPECIAL EXCHANGE SERVICES

J. CORE CONNECT (Cont'd)

IV. **Application of Rates**

(T)

A. The monthly rates include the Local Exchange Service, EAS, and features only. These rates do not include the monthly charges for **HSI or for the qualifying long distance plan, if applicable.**

(T)

(T)

B. Service Connection Charges, as described in Section 18 of the General Exchange Tariff apply for new and additional CORE CONNECT lines, and moves of existing lines. Service Connection Charges may be waived for customers who move services from another telecommunications service provider to CORE CONNECT under a one, two or three-year TDP.

C. Service Connection Charges do not apply when CORE CONNECT replaces existing Local Exchange Service. Service Connection charges do apply when Customers request a change from CORE CONNECT back to Local Exchange Service.

(M)

(M)

(M) Material now appears on Page Nos. 36 and 37.

NE 14-03



UNITED TELEPHONE COMPANY OF THE WEST - NEBRASKA d/b/a CENTURYLINK
GENERAL EXCHANGE PRICE LIST

SECTION 2
PAGE: 36
RELEASE: 2
EFFECTIVE: April 29, 2014

ISSUED: April 17, 2014

SPECIAL EXCHANGE SERVICES

J. CORE CONNECT (Cont'd)

V. Rates and Charges

1. **Core Connect 1** ^[1]

Business Individual Line Service or Key Trunk Service

Rotary Hunt Service (optional)

Choice of the following features and services:

- Caller ID with Name (includes Anonymous Call Rejection)
- Call Forwarding
- Call Forward Busy - Fixed
- Call Forward No Answer - Fixed
- Enhanced Call Waiting
- Call Waiting ID
- Three-Way Calling
- Call Transfer
- Return Call
- SignalRing
- Repeat Dial
- Message Waiting
- Voicemail ^[2]

Exchanges	Per Location, Per Month				
	Initial Bundle	2 nd through 10 th bundle			
		All Terms	Month-to-Month	One Year Term	Two Year Term
Broadwater, Lewellen, Lyman, Potter	\$80.00	\$50.00	\$45.00	\$42.50	\$40.00
All Other Exchanges	60.00	40.00	35.00	32.50	30.00

^[1] Customers must also subscribe to the Embarq Communications, Inc. Business Assist Advantage - Business Unlimited (**Option 2**) long distance plan for each CORE CONNECT 1 line or trunk subscribed.

^[2] Deregulated service.

(M) Material previously appeared on Page No. 32.
(M) Material previously appeared on Page No. 35.
(M2) Material previously appeared on Page No. 33.

(T)

(M)

(M)

(T)(M1)

(T)(M1)

(T)(M2)

(T)(M2)

(M)

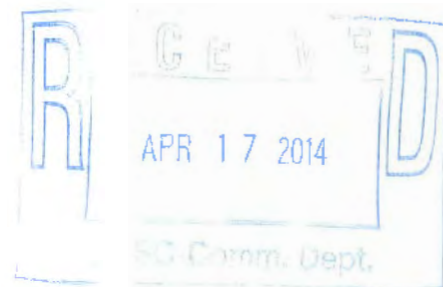

UNITED TELEPHONE COMPANY OF THE WEST - NEBRASKA d/b/a CENTURYLINK
GENERAL EXCHANGE PRICE LIST

SECTION 2

PAGE: 37

RELEASE: 1

EFFECTIVE: April 29, 2014

ISSUED: April 17, 2014

SPECIAL EXCHANGE SERVICES

J. CORE CONNECT (Cont'd)

(N)

V. Rates and Charges (Cont'd)

(N)

2. Core Connect 1 LITE

(T) (M)

Business Individual Line Service or Key Trunk Service

Rotary Hunt Service (optional)

Choice of the following features and services:

Caller ID with Name (includes Anonymous Call Rejection)

Call Forwarding

Call Forward Busy - Fixed

Call Forward No Answer - Fixed

Enhanced Call Waiting

Call Waiting ID

Three-Way Calling

Call Transfer

Return Call

SignalRing

Message Waiting

Voicemail ^[1]

Exchanges	Per Location, Per Month				
	Initial Bundle	2 nd through 10 th bundle			
	All Terms	Month-to-Month ^[2]	One Year Term	Two Year Term	Three Year Term
Broadwater, Lewellen, Lyman, Potter	\$80.00	\$50.00	\$45.00	\$42.50	\$40.00
All Other Exchanges	60.00	40.00	35.00	32.50	30.00

(M)
(T)(M1)

(T)(M1)

[1] Deregulated service.

(M)

[2] Core Connect 1 LITE customers must initially subscribe to a one-year, two-year or three-year term plan. Month-to-month rates are available upon expiration of a TDP when customers do not renew or select a new TDP option.

(T)(M2)

(T)(M2)

(M) Material previously appeared on Page No. 32.1.

(M1) Material previously appeared on Page No. 35.

(M2) Material previously appeared on Page No. 33.

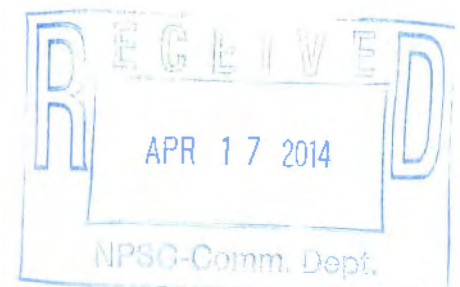

UNITED TELEPHONE COMPANY OF THE WEST - NEBRASKA d/b/a CENTURYLINK
 GENERAL EXCHANGE PRICE LIST

SECTION 2

PAGE: 38

RELEASE: 1

EFFECTIVE: April 29, 2014

ISSUED: April 17, 2014

SPECIAL EXCHANGE SERVICES

J. CORE CONNECT (Cont'd)

V. Rates and Charges

3. Core Connect 2 ^[1]

Business Individual Line Service or Key Trunk Service

Rotary Hunt Service (optional)

Choice of the following features and services:

Caller ID with Name (includes Anonymous Call Rejection)

Call Forwarding

Call Forward Busy - Fixed

Call Forward No Answer - Fixed

Enhanced Call Waiting

Call Waiting ID

Three-Way Calling

Call Transfer

Return Call

SignalRing

Repeat Dial

Selective Call Rejection

Message Waiting

Voicemail ^[2]

Exchanges	Per Location, Per Month				
	Initial Bundle	2 nd through 10 th bundle			
	All Terms	Month-to-Month	One Year Term	Two Year Term	Three Year Term
All Exchanges	\$55.00	\$35.00	\$30.00	\$27.50	\$25.00

[1] Customers must also subscribe to the Embarq Communications, Inc. Business Assist Advantage - Business Unlimited (Option 3) long distance plan for each CORE CONNECT 2 line or trunk subscribed.

[2] Deregulated service.

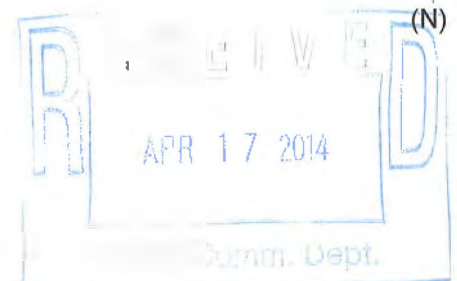

(N)

UNITED TELEPHONE COMPANY OF THE WEST - NEBRASKA d/b/a CENTURYLINK
 GENERAL EXCHANGE PRICE LIST

SECTION 2

PAGE: 39

RELEASE: 1

ISSUED: April 17, 2014

EFFECTIVE: April 29, 2014

SPECIAL EXCHANGE SERVICES

J. CORE CONNECT (Cont'd)

V. Rates and Charges (Cont'd)

4. Core Connect 2 LITE

Business Individual Line Service or Key Trunk Service
 Rotary Hunt Service (optional)

Choice of the following features and services:

- Caller ID with Name (includes Anonymous Call Rejection)
- Call Forwarding
- Call Forward Busy - Fixed
- Call Forward No Answer - Fixed
- Enhanced Call Waiting
- Call Waiting ID
- Three-Way Calling
- Call Transfer
- Return Call
- SignalRing
- Selective Call Rejection
- Message Waiting
- Voicemail ⁽¹⁾

Exchanges	Per Location, Per Month				
	Initial Bundle	2 nd through 10 th bundle			
		All Terms	Month-to-Month ⁽²⁾	One Year Term	Two Year Term
All Exchanges	\$60.00	\$35.00	\$30.00	\$27.50	\$25.00

⁽¹⁾ Deregulated service.

⁽²⁾ Core Connect 2 LITE customers must initially subscribe to a one-year, two-year or three-year term plan. Month-to-month rates are available upon expiration of a TDP when customers do not renew or select a new TDP option.



(N)

(N)

UNITED TELEPHONE COMPANY OF THE WEST - NEBRASKA d/b/a CENTURYLINK
GENERAL EXCHANGE PRICE LIST

SECTION 2
PAGE: 40
RELEASE: 3

ISSUED: June 4, 2019

EFFECTIVE: June 14, 2019

SPECIAL PACKAGED OFFERINGS

K. CENTURYLINK BUSINESS BUNDLES (C)

I. General

1. CENTURYLINK BUSINESS BUNDLES are optional enrollment plans available to business customers with up to twenty-five access lines and/or key trunks across all service territories served by CenturyLink incumbent local exchange carriers (each, a CenturyLink ILEC). This plan permits business customers who subscribe to qualifying products and services to receive Local Exchange Service and additional features and services specified in III. following for a flat monthly rate. (T)
2. CENTURYLINK BUSINESS BUNDLES are available for a maximum of ten (10) business lines at each customer location. (T)

II. Regulations

1. Customers must also subscribe to companion long distance service provided by CenturyLink Communications, LLC for the initial and each additional bundle and the Company's 1.5 Mbps or greater High-Speed Internet provided by the Company or a CenturyLink affiliate at each bundle location. In locations where 1.5 Mbps is not available, customers may alternatively subscribe to the Company's non-regulated 512 or 768 Kbps HSI. The qualifying High-Speed Internet service must be billed on the same invoice as the CENTURYLINK BUSINESS BUNDLE but may be provisioned on access lines or trunks other than CENTURYLINK BUSINESS BUNDLE. Specific requirements are as follows: (T)
 - a. CENTURYLINK BUSINESS BUNDLE Option 1 - Month-To-Month Option (C)
 - CenturyLink Business Bundle Unlimited Plan A long distance plan, and (C)
 - Non-regulated 1.5 Mbps or greater High-speed Internet on a month-to-month basis or under a two-year term minimum commitment period at each CENTURYLINK BUSINESS BUNDLE location.
 - b. CENTURYLINK BUSINESS BUNDLE Option 2 - Two-Year Term Option (C)
 - CenturyLink Business Bundle Unlimited Plan A long distance plan, and (C)
 - Non-regulated 1.5 Mbps or greater High-speed Internet under a two-year term minimum commitment period at each location.

(M)
|
(M)

(M) Material moved to Page 40.1.

NE 19-05

Received

JUN - 4 2019

NPSC Comm. Dept.

UNITED TELEPHONE COMPANY OF THE WEST - NEBRASKA d/b/a CENTURYLINK
GENERAL EXCHANGE PRICE LIST

SECTION 2
PAGE: 40.1
RELEASE: 1

ISSUED: June 4, 2019

EFFECTIVE: June 14, 2019

SPECIAL PACKAGED OFFERINGS

K. CENTURYLINK BUSINESS BUNDLES

II. Regulations

1. (Cont'd)

c. CenturyLink Business Bundle Preferred

- CenturyLink Business Bundle Unlimited Plan B long distance plan, and
 - Non-regulated 1.5 Mbps or greater High-speed Internet on a month-to-month basis or under a two-year term minimum commitment period at each bundle location.
2. There is no minimum service period for the Local Exchange Service and features provided in CENTURYLINK BUSINESS BUNDLE. Customers who discontinue this service within thirty days after establishment of service will be charged only for the number of days of service.
3. CENTURYLINK BUSINESS BUNDLE lines cannot terminate into a PBX or other line trunking device except as otherwise indicated herein.
4. Components of the CENTURYLINK BUSINESS BUNDLE selected by the customer will be converted to a la carte rates for the remaining services if customers remove any of the qualifying services. If the qualifying High-Speed Internet service is discontinued at any bundle location, components of all CENTURYLINK BUSINESS BUNDLES at that location will be converted to ala carte rates. No termination liability charges will apply for the regulated portion(s) of a CENTURYLINK BUSINESS BUNDLE if a qualifying service is discontinued prior to the minimum service period or term commitment period for that qualifying service. Early Termination Fees may apply if non-regulated HSI is discontinued prior to the end of a two-year commitment.
5. All terms and conditions specified elsewhere for the respective services/features requested as part of this plan shall apply.

(N)

(N)

(M)

(M)

(M1)

(T)

(T)

(T)

(T)

(M1)

(M) Material moved from Page 40.

(M1) Material moved from Page 41.

NE 19-05

Received

JUN - 4 2019

NPSC Comm. Dept.

UNITED TELEPHONE COMPANY OF THE WEST - NEBRASKA d/b/a CENTURYLINK
GENERAL EXCHANGE PRICE LIST

SECTION 2
PAGE: 41
RELEASE: 3

ISSUED: June 4, 2019

EFFECTIVE: June 14, 2019

SPECIAL PACKAGED OFFERINGS

K. CENTURYLINK BUSINESS BUNDLES (Cont'd) (C)

II. Regulations (Cont'd) (M)
|
(M)

6. Services selected as part of this plan can only be provided where technically available and compatible with other services the customer may choose to order.

7. CENTURYLINK BUSINESS BUNDLES cannot be combined with any other discounts unless otherwise specified. (C)

8. This plan is not available to customers who are or become toll restricted. Service Connection Charges will not apply for those existing lines converted, in-place, to business exchange service due to company-initiated toll restrictions. Such customers will not be permitted to re-enroll in this plan until such time as all associated unpaid balances are satisfactorily paid in full.

9. An Activation Fee will apply for the month-to-month option in lieu of any other Service Charge(s), except that if a premises visit is required in order to establish service, the nonrecurring charge normally applicable for a premises visit will apply in addition to the Activation Fee. The Activation Fee will be waived when: (T)

- customer migrates existing Local Exchange Service lines to a CENTURYLINK BUSINESS BUNDLE, or (T)
- customer orders CENTURYLINK BUSINESS BUNDLE additional lines subsequent to establishment of the initial line, or
- customer orders initial and/or additional lines and selects the two-year term commitment for the required High-Speed Internet service. (T)

The Activation Fee does not apply for the two-year term option.

(M) Material moved to Page 40.1.

NE 19-05

Received

JUN - 4 2019

NPSC Comm. Dept.

UNITED TELEPHONE COMPANY OF THE WEST - NEBRASKA d/b/a CENTURYLINK
GENERAL EXCHANGE PRICE LIST

SECTION 2
PAGE: 42
RELEASE: 3

ISSUED: June 4, 2019

EFFECTIVE: June 14, 2019

SPECIAL PACKAGED OFFERINGS

K. CENTURYLINK BUSINESS BUNDLES (Cont'd) (C)

III. Service Description and Rates (C)

1. CenturyLink Business Bundle Options 1 and 2 (N)

a. Description (N)

CENTURYLINK BUSINESS BUNDLE Options 1 and 2 include a flat rate Business Individual Line Service or Key Trunk with Touch tone, flat rate Extended Area Service, unlimited expanded local call (where available) and the following optional services and features: (C)

- Rotary Hunt Service
- Busy Redial (aka Repeat Dial)
- Caller ID with Name (includes Anonymous Call Rejection)
- Call Forwarding
- Call Forward Busy - Fixed
- Call Forward No Answer - Fixed
- Call Forward Remote Activation
- Enhanced Call Waiting
- Call Waiting ID
- Three-Way Calling
- Three-Way Calling with Transfer
- Return Call
- SignalRing
- Selective Call Rejection
- Selective Call Acceptance
- Message Waiting
- Voicemail ⁽¹⁾

b. Rates and Charges (T)

Monthly rates for the CenturyLink Business Bundle Unlimited Plan A long distance plan provided by CenturyLink Communications, LLC and for deregulated High-Speed Internet provided by the Company are not included in the following rates; however, the monthly rates for all these services will appear as a single line item on the customer's bill. (M)(T)

CenturyLink Business Bundle Per Line, Per Location	Monthly Rate		Activation Fee
	Initial Bundle	2nd through 10th Bundle	
Month-to-Month (Option 1)	\$45.00	\$19.99	\$50.00
Two-Year Term (Option 2)	45.00	19.99	N/A

⁽¹⁾ Deregulated service. (D)

(M) Material moved within this page. (C)

Received

JUN -4 2019

NPSC Comm. Dept.

UNITED TELEPHONE COMPANY OF THE WEST - NEBRASKA d/b/a CENTURYLINK
 GENERAL EXCHANGE PRICE LIST

SECTION 2
 PAGE: 42.1
 RELEASE: 1

ISSUED: June 4, 2019

EFFECTIVE: June 14, 2019

SPECIAL PACKAGED OFFERINGS

K. CENTURYLINK BUSINESS BUNDLES (Cont'd)

III. Service Description and Rates

2. CenturyLink Business Bundle Preferred

a. Description

CenturyLink Business Bundle Preferred includes a flat rate Business Individual Line or Key Trunk with Touch tone, flat rate Extended Area Service, unlimited expanded local calling (where available), and the following optional services and features:

- Rotary Hunt Service
- Busy Redial (aka Repeat Dial)
- Caller ID with Name (Includes Anonymous Call Rejection)
- Call Forwarding
- Call Forward Busy - Fixed
- Call Forward No Answer - Fixed
- Call Forward Remote Activation
- Selective Call Forwarding
- Call Waiting/Cancel Call Waiting (a.k.a. Enhanced Call Waiting)
- Call Waiting ID
- Three-Way Calling or Three-Way Calling with Transfer
- Return Call
- Selective Call Rejection
- Message Waiting
- Voicemail ⁽¹⁾

b. Rates and Charges

Monthly rates for the CenturyLink Business Bundle Unlimited Plan B long distance plan provided by CenturyLink Communications, LLC and for deregulated High-Speed Internet provided by the Company are not included in the following rates; however, the monthly rates for all these services will appear as a single line item on the customer's bill.

CenturyLink Business Bundle Preferred	Monthly Rate		Activation Fee
	Initial Bundle	2nd through 10th Bundle	
Month-to-Month	\$50.00	\$19.99	\$50.00
2-Year Term	50.00	19.99	0.00

⁽¹⁾ Deregulated service.

Received

JUN - 4 2019

NPSC Comm. Dept.

(N)

(N)

UNITED TELEPHONE COMPANY OF THE WEST d/b/a CenturyLink
NEBRASKA
GENERAL EXCHANGE PRICE LIST

SECTION 2
PAGE: 43
RELEASE: 3

ISSUED: February 8, 2019

EFFECTIVE: February 18, 2019

SPECIAL PACKAGED OFFERINGS

L. UNLIMITED NATIONWIDE CALLING OR ESSENTIAL HOME PHONE WITH 30 MINUTES
LONG DISTANCE ^[1]

(C)

I. Description

- A. Unlimited Nationwide Calling or Essential Home Phone with 30 Minutes Long Distance (hereafter referred to as Essential Home Phone w/ 30 Minutes LD) is an optional enrollment plan that permits residence customers who subscribe to qualifying products and services to receive Local Exchange Service and additional features and services for a flat monthly rate.
- B. Customers must subscribe to either the Unlimited Nationwide Calling or 30 Minutes Long Distance calling plan provided by CenturyLink Communications, LLC for each package provided at a customer location.
- C. Unlimited Nationwide Calling or Essential Home Phone w/ 30 Minutes LD includes a flat rate one-party residence line with Touch tone, flat rate Extended Area Service, unlimited expanded local calling (where available), and the following services and features:
- Anonymous Call Rejection
 - Call Forward Busy – Fixed
 - Call Forward No Answer – Fixed
 - Call Forward Remote Access (where available)
 - Call Forwarding
 - Call Waiting ID
 - Caller ID with Name
 - Enhanced Call Waiting (includes Cancel Call Waiting)
 - Message Waiting
 - Repeat Dial
 - Return Call
 - Selective Call Acceptance
 - Selective Call Forwarding
 - Selective Call Rejection
 - Selective Call Ring
 - Three-Way Calling
 - Voicemail ^[2]

(T)

^[1] **Effective February 18, 2019, Essential Home Phone With 30 Minutes Long Distance is grandfathered. Availability to current customers is limited to lines and features in service at existing locations.**

(N)

(N)

^[2] Deregulated service.

NE 19-02

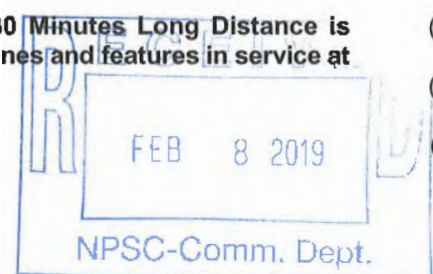

(T)

UNITED TELEPHONE COMPANY OF THE WEST d/b/a CenturyLink
NEBRASKA
GENERAL EXCHANGE PRICE LIST

SECTION 2
PAGE: 44
RELEASE: 3

ISSUED: February 8, 2019

EFFECTIVE: February 18, 2019

SPECIAL PACKAGED OFFERINGS

L. UNLIMITED NATIONWIDE CALLING OR ESSENTIAL HOME PHONE WITH 30 MINUTES LONG DISTANCE ⁽¹⁾ (Cont'd)

(C)

II. Regulations

- A. Components of the Unlimited Nationwide Calling or Essential Home Phone w/ 30 Minutes LD will be converted to ala carte rates for the remaining services if customers remove any of the qualifying services.
- B. All terms and conditions specified elsewhere for the respective services/features requested as part of this plan shall apply.
- C. Services selected as part of this plan can only be provided where technically available and compatible with other services the customer may choose to order.

Unlimited Nationwide Calling or Essential Home Phone w/ 30 Minutes LD cannot be combined with any other discounts unless otherwise specified.

- E. This plan is not available to customers who are or become toll restricted. Service Charges will not apply for those existing lines converted, in-place, to residence exchange service due to company-initiated toll restrictions. Such customers will not be permitted to re-enroll in this plan until such time as all associated unpaid balances are satisfactorily paid in full.

III. Rates and Charges

- A. The monthly rate includes a flat rate one-party residence line with Touch tone, flat rate EAS, expanded local calling (where available), features, and the following fees and surcharges: Interstate Subscriber Line Charge, Intrastate Subscriber Line Charge (where applicable), Access Recovery Charge, and Facilities Relocation Charge.
- B. Service Charges will not apply for new and additional package lines and moves of existing lines.
- C. Service Charges do not apply when Unlimited Nationwide Calling or Essential Home Phone w/ 30 Minutes LD replaces existing Local Exchange Service. The normally applicable Service Charges do apply when Customers request a change back to Local Exchange Service.

⁽¹⁾ Effective February 18, 2019, Essential Home Phone With 30 Minutes Long Distance is grandfathered. Availability to current customers is limited to lines and features in service at existing locations.

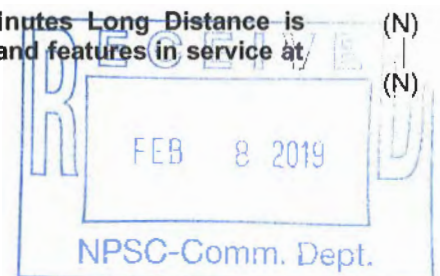

UNITED TELEPHONE COMPANY OF THE WEST d/b/a CenturyLink
NEBRASKA
GENERAL EXCHANGE PRICE LIST

SECTION 2
PAGE: 45
RELEASE: 3

ISSUED: February 8, 2019

EFFECTIVE: February 18, 2018

SPECIAL PACKAGED OFFERINGS

L. UNLIMITED NATIONWIDE CALLING OR ESSENTIAL HOME PHONE WITH 30 MINUTES LONG DISTANCE ^[1] (Cont'd) (C)

C. Rates and Charges (Cont'd)

- D. The Company retains the right, in its sole discretion, to change some or all of the network technology on which it delivers this service and the associated long distance service, including a change to Voice over Internet Protocol technology. If the Company's network technology changes in such a way that this tariff will no longer apply to Unlimited Nationwide Calling or Essential Home Phone w/ 30 Minutes LD, the following monthly rate will continue to apply, and the new service(s) or plan(s) will be governed by separate, commercial terms between the Company and the customer.

Unlimited Nationwide Calling or Essential Home Phone w/ 30 Minutes LD	Monthly Rate
Per package, per location	\$35.00 ^[2]

(T)

^[1] Effective February 18, 2019, Essential Home Phone With 30 Minutes Long Distance is grandfathered. Availability to current customers is limited to lines and features in service at existing locations. (N)

^[2] Rate includes local services, features, fees and surcharges described in III.A. preceding. Monthly rates for the Unlimited Nationwide Calling or 30 Minutes Long Distance calling plan provided by CenturyLink Communications, LLC and for optional deregulated High Speed Internet provided by the Company are not included in this rate; however, the monthly rates for all these services will appear as a single line item on the customer's bill. (T)

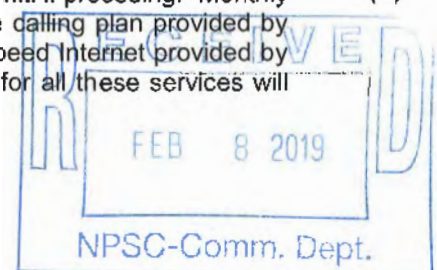

UNITED TELEPHONE COMPANY OF THE WEST d/b/a CenturyLink
NEBRASKA
GENERAL EXCHANGE PRICE LIST

SECTION 2

PAGE: 46

RELEASE: 1

ISSUED: August 6, 2021

EFFECTIVE: August 16, 2021

SPECIAL PACKAGED OFFERINGS

M. SIMPLY UNLIMITED BUSINESS

1. Description

- a. Simply Unlimited Business is an optional enrollment plan that permits business customers who subscribe to qualifying products and services to receive Local Exchange Service an additional features and services for a flat monthly rate.
- b. Simply Unlimited Business is available for a maximum of twenty business lines and/or key trunks at a given customer location, not to exceed twenty-five lines across all customer locations in territories served by a CenturyLink incumbent local exchange carrier.
- c. Customers must also subscribe to companion long distance service provided by CenturyLink Communications, LLC for the initial and each additional bundle.
- d. Customers may also subscribe to Company's 1.5 Mbps or greater High-Speed Internet provided by the Company or a CenturyLink affiliate: at each bundle location. In locations where 1.5 Mbps is not available, customers may alternatively subscribe to the Company's non-regulated 512 or 768 Kbps HSI. The qualifying High-Speed Internet service must be billed on the same invoice as the Simply Unlimited Business but may be provisioned on access lines or trunks other than Simply Unlimited Business.
- e. Simply Unlimited Business includes a flat rate one-party business line or key trunk with Touch Tone, flat rate Extended Area Service, unlimited expanded local calling (where applicable) and the following services and features, where available:

Rotary Hunt Service
Busy Redial (aka Repeat Dial)
Caller ID with Name (includes Anonymous Call Rejection)
Call Forwarding
Call Forward Busy - Fixed
Call Forward No Answer – Fixed
Call Forward Remote Activation
Selective Call Forwarding
Call Waiting/Cancel Call Waiting (a.k.a. Enhanced Call Waiting)
Call Waiting ID
Three-Way Calling or Three-Way Calling with Transfer
Return Call
Selective Call Rejection (a.k.a. Call Rejection)
Message Waiting
Voicemail (Deregulated Service)

UNITED TELEPHONE COMPANY OF THE WEST d/b/a CenturyLink
NEBRASKA
GENERAL EXCHANGE PRICE LIST

SECTION 2
PAGE: 47
RELEASE: 1

ISSUED: August 6, 2021

EFFECTIVE: August 16, 2021

SPECIAL PACKAGED OFFERINGS

M. SIMPLY UNLIMITED BUSINESS

2. Regulations

- a. Simply Unlimited Business lines cannot terminate into a PBX or other line trunking device except as otherwise indicated herein.
- b. Services selected as part of this plan can only be provided where technically available and compatible with other services the customer may choose to order. All terms and conditions specified elsewhere for the respective services/features requested as part of this plan shall apply.
- c. There is no minimum service period for the Local Exchange Service and features provided in Simply Unlimited Business. Customers who discontinue this service within thirty days after establishment of service will be charged only for the number of days of service.
- d. If customers discontinue any of the required services or features, the remaining components of the Simply Unlimited Business selected by the customer will be converted to a la carte rates. If optional High-Speed Internet service is discontinued at any bundle location, the discounted monthly rate will no longer apply and all Simply Unlimited Business lines at that location will be converted to the applicable monthly rate.
- e. Simply Unlimited Business is not available to customers who are or become toll restricted. Service Connection Charges will not apply for those existing lines converted, in-place, to business exchange service due to company-initiated toll restrictions. Such customers will not be permitted to re-enroll in this plan until such time as all associated unpaid balances are satisfactorily paid in full.
- f. Simply Unlimited Business cannot be combined with any other discounts unless otherwise specified.
- g. The Company retains the right, in its sole discretion, to change some or all of the network technology on which it delivers this service and the associated long distance service, including a change to Voice over Internet Protocol technology. If the Company's network technology changes in such a way that this tariff will no longer apply to Simply Unlimited Business, the following monthly rate will continue to apply until such time as customers are notified in advance of rate increases, and the new service(s) or plan(s) will be governed by separate, commercial terms between the Company and the customer.

UNITED TELEPHONE COMPANY OF THE WEST d/b/a CenturyLink
NEBRASKA
GENERAL EXCHANGE PRICE LIST

SECTION 2
PAGE: 48
RELEASE: 1

ISSUED: August 6, 2021

EFFECTIVE: August 16, 2021

SPECIAL PACKAGED OFFERINGS

M. SIMPLY UNLIMITED BUSINESS (Cont'd)

3. Application of Rates and Charges

- a. An Activation Fee will apply for the month-to-month option in lieu of any other Service Charge(s), except that if a premises visit is required in order to establish service, the nonrecurring charge normally applicable for a premises visit will apply in addition to the Activation Fee. The Activation Fee will be waived when:
 - customer migrates existing Local Exchange Service lines to Simply Unlimited Business, or
 - customer orders Simply Unlimited Business additional lines subsequent to establishment of the initial line, or
 - customer orders optional High-Speed Internet at each bundle location.
- b. The normally applicable service charges will apply when Simply Unlimited Business customers request a change back to Local Exchange Service or another packaged service.
- c. The monthly rate includes a flat rate one-party business line or key trunk with Touch tone, flat rate EAS, expanded local calling (where available), features, unlimited long distance provided by CenturyLink Communications, Inc., and the following fees and surcharges: Interstate Subscriber Line Charge, Intrastate Subscriber Line Charge (where applicable), and Access Recovery Charge.
- d. Simply Unlimited Business includes a rate stability plan which allows customers to pay a fixed monthly rate that is not subject to rate changes over a fixed period. Customers will pay the tariffed rate in effect as of the service establishment date for the first twelve months after service is established. On the service establishment anniversary date, the customer's monthly rate will increase to the lesser of the then-prevailing tariffed rate or a rate that is \$5.00 higher than the rate in effect on the service establishment date. Thereafter, on each subsequent anniversary date, the monthly rate may increase by no more than \$5.00, not to exceed the then-prevailing tariffed rate.
- e. Simply Unlimited Business lines subsequently added to the customer's account will be charged the monthly tariffed rate in effect as of the date the new Simply Unlimited Business line(s) is/are added to the account. The same rate stability provisions apply to subsequently added lines, based on the service establishment date for those lines.

UNITED TELEPHONE COMPANY OF THE WEST d/b/a CenturyLink
NEBRASKA
GENERAL EXCHANGE PRICE LIST

SECTION 2

PAGE: 49

RELEASE: 1

ISSUED: August 6, 2021

EFFECTIVE: August 16, 2021

SPECIAL PACKAGED OFFERINGS

M. SIMPLY UNLIMITED BUSINESS

3. Application of Rates and Charges (Cont'd)

- f. Customers will be notified at least thirty days prior to any service anniversary date rate increase. Such notice will include the actual amount by which customer's Simply Unlimited Business will increase.
- g. The following monthly rates do not include applicable charges for non-regulated High-Speed Internet provided by the Company. However, the rates described in M.3.c. preceding and the rate for High-Speed Internet will appear as a single line item on the customer's bill. Zone charges do not apply.

4. Rates and Charges

Option	Monthly Rate		Activation Fee ⁽¹⁾
	Initial Bundle	Each Additional Bundle	
Simply Unlimited Business with Long Distance	\$50.00	\$50.00	\$50.00
Simply Unlimited Business with Long Distance and High-Speed Internet ⁽²⁾	40.00	35.00	50.00

⁽¹⁾ Activation Fee may be waived as described in M.3.A.

⁽²⁾ This monthly rate and the applicable rate for HSI will appear on invoice as a single line item.

UNITED TELEPHONE COMPANY OF THE WEST d/b/a CenturyLink
NEBRASKA
GENERAL EXCHANGE PRICE LIST

SECTION 2
PAGE: 50
RELEASE: 1

ISSUED: September 7, 2021

EFFECTIVE: September 18, 2021

SPECIAL PACKAGED OFFERINGS

N. SIMPLY UNLIMITED PHONE FOR RESIDENCE

1. Description

- a. Simply Unlimited Phone is an optional enrollment plan that permits residence customers who subscribe to qualifying products and services to receive Local Exchange Service and additional features and services for a flat monthly rate.
- b. Customers must subscribe to the Simply Unlimited Phone for Residence calling plan provided by CenturyLink Communications, LLC for each package provided at a customer location.
- c. Simply Unlimited Phone for Residence includes a flat rate one-party residence line with Touch tone, flat rate Extended Area Service, unlimited expanded local calling (where available), and the following services and features:
 - Anonymous Call Rejection
 - Call Forward Busy – Fixed
 - Call Forward No Answer – Fixed
 - Call Forward Remote Access (where available)
 - Call Forwarding
 - Call Waiting ID
 - Caller ID with Name
 - Enhanced Call Waiting (includes Cancel Call Waiting)
 - Message Waiting
 - Repeat Dial
 - Return Call
 - Selective Call Forwarding
 - Selective Call Rejection
 - Selective Call Ring
 - Speed Call 8
 - Three-Way Calling
 - Voicemail (Deregulated Service)

UNITED TELEPHONE COMPANY OF THE WEST d/b/a CenturyLink
NEBRASKA
GENERAL EXCHANGE PRICE LIST

SECTION 2
PAGE: 51
RELEASE: 1

ISSUED: September 7, 2021

EFFECTIVE: September 18, 2021

SPECIAL PACKAGED OFFERINGS

N. SIMPLY UNLIMITED PHONE FOR RESIDENCE (CONT'D)

2. Regulations

- a. Components of the Simply Unlimited Phone will be converted to ala carte rates for the remaining services if customers remove any of the qualifying services.
- b. All terms and conditions specified elsewhere for the respective services/features requested as part of this plan shall apply.
- c. Services selected as part of this plan can only be provided where technically available and compatible with other services the customer may choose to order.
- d. Simply Unlimited Phone cannot be combined with any other discounts unless otherwise specified.
- e. This plan is not available to customers who are or become toll restricted. Service Charges will not apply for those existing lines converted, in-place, to residence exchange service due to company-initiated toll restrictions. Such customers will not be permitted to re-enroll in this plan until such time as all associated unpaid balances are satisfactorily paid in full.
- f. The Company retains the right, in its sole discretion, to change some or all of the network technology on which it delivers this service and the associated long distance service, including a change to Voice over Internet Protocol technology. If the Company's network technology changes in such a way that this tariff will no longer apply to Simply Unlimited Phone, the following monthly rate will continue to apply, and the new service(s) or plan(s) will be governed by separate, commercial terms between the Company and the customer.

3. Application of Rates and Charges

- a. The monthly rate includes a flat rate one-party residence line with Touch tone, flat rate EAS, expanded local calling (where available), features, and the following fees and surcharges: Interstate Subscriber Line Charge, Intrastate Subscriber Line Charge (where applicable), Access Recovery Charge, and Facilities Relocation Charge.
- b. Service Charges will not apply for new and additional package lines and moves of existing lines.
- c. Service Charges do not apply when Simply Unlimited Phone replaces existing Local Exchange Service. The normally applicable Service Charges do apply when Customers request a change back to Local Exchange Service.

UNITED TELEPHONE COMPANY OF THE WEST d/b/a CenturyLink
NEBRASKA
GENERAL EXCHANGE PRICE LIST

SECTION 2
PAGE: 52
RELEASE: 1

ISSUED: September 7, 2021

EFFECTIVE: September 18, 2021

SPECIAL PACKAGED OFFERINGS

N. SIMPLY UNLIMITED PHONE FOR RESIDENCE

3. Application of Rates and Charges (Cont'd)

- d. Simply Unlimited Phone includes a rate stability plan which allows customers to pay a fixed monthly rate that is not subject to rate changes over a fixed period. Customers will pay the tariffed rate in effect as of the service establishment date for the first twelve months after service is established. On the service establishment anniversary date, the customer's monthly rate will increase to the lesser of the then-prevailing tariffed rate or a rate that is \$5.00 higher than the rate in effect on the service establishment date. Thereafter, on each subsequent anniversary date, the monthly rate may increase by no more than \$5.00, not to exceed the then-prevailing tariffed rate.
- e. Simply Unlimited Phone lines subsequently added to the customer's account will be charged the monthly tariffed rate in effect as of the date the new Simply Unlimited Phone line(s) is/are added to the account. The same rate stability provisions apply to subsequently added lines, based on the service establishment date for those lines.
- f. Customers will be notified at least thirty days prior to any service anniversary date rate increase. Such notice will include the actual amount by which customer's Simply Unlimited Phone will increase.

4. Rates and Charges

The following monthly rates include local services, features, fees and surcharges described in 3.A. preceding. Monthly rates for the Simply Unlimited Phone calling plan provided by CenturyLink Communications, LLC and for optional deregulated High Speed Internet provided by the Company are not included in this rate; however, the monthly rates for all these services will appear as a single line item on the customer's bill.

Option	Monthly Rate ^[1] Per package, per location
Simply Unlimited Phone with Long Distance	\$45.00
Simply Unlimited Phone with Long Distance and deregulated HSI	\$35.00

^[1] Rates do not include the monthly charges for HSI or for the qualifying long distance plan, if applicable.

UNITED TELEPHONE COMPANY OF THE WEST - NEBRASKA d/b/a CENTURYLINK
GENERAL EXCHANGE
PRICE LIST

(C)

SECTION 3

PAGE: 1

RELEASE: 4

ISSUED: November 21, 2011

EFFECTIVE: December 1, 2011

MISCELLANEOUS SERVICES

I. RESERVED FOR FUTURE USE

(C)

(D)

(D)

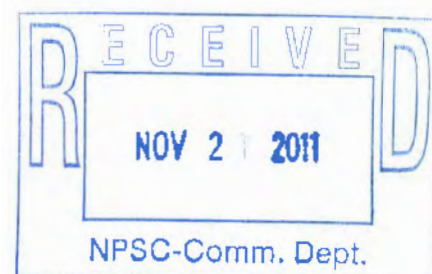

UNITED TELEPHONE COMPANY OF THE WEST - NEBRASKA d/b/a CENTURYLINK
GENERAL EXCHANGE
PRICE LIST

(C)

SECTION 3

PAGE: 2

RELEASE: 8

ISSUED: November 21, 2011

EFFECTIVE: December 1, 2011

MISCELLANEOUS SERVICES

I. RESERVED FOR FUTURE USE (Cont'd)

(C)

(D)

(D)

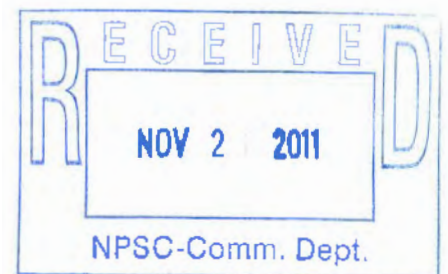

UNITED TELEPHONE COMPANY OF THE WEST - NEBRASKA
GENERAL EXCHANGE
PRICE LIST

SECTION 3
PAGE: 3
RELEASE: 9

ISSUED: April 21, 2015

EFFECTIVE: May 1, 2015

MISCELLANEOUS SERVICES

II. RESERVED FOR FUTURE USE

(D)

NE 15-03

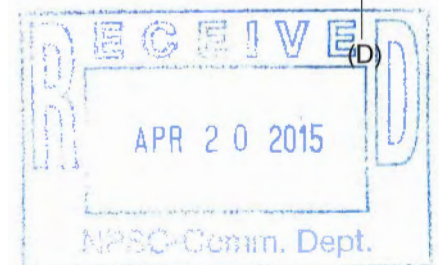

UNITED TELEPHONE COMPANY OF THE WEST - NEBRASKA d/b/a CENTURYLINK
GENERAL EXCHANGE
PRICE LIST

SECTION 3
PAGE: 4
RELEASE: 2

ISSUED: January 21, 2011

EFFECTIVE: February 1, 2011

MISCELLANEOUS SERVICES

III. SATISFACTION GUARANTEE PROGRAM

A. GENERAL

1. **A Satisfaction Guarantee Program is available to business customers who subscribe to any of the following qualifying services:**

Individual Business Line	Key Trunk
PBX Trunk	Centrex

2. **When business customers notify the Telephone Company within thirty (30) days after installation of a qualifying service(s) that they are not satisfied with their service(s) and subsequently request disconnection of that service(s), they are eligible to receive a full credit of all nonrecurring charges directly associated with the establishment of the qualifying service(s) and the monthly charges billed for the service(s) through the date of disconnection.**
3. **To receive credit, the customer must submit a cancellation notice to the Telephone Company via a web based on-line form within thirty days of the service installation date and at least 5 days before the Telephone Company receives a disconnection request from the customer or the customer's new service provider.**
4. **When the last day of the thirty-day period falls on a weekend or legal holiday, the customer must submit the web-based cancellation notice no later than the first business day following the weekend or legal holiday, to be eligible for credit.**
5. **Customers who request disconnection under this program will not be assessed an early termination fee or payment of any minimum service period amounts that would otherwise apply for early disconnection of the service(s).**
6. **Reimbursements will be issued in the form of a bill credit or check. The customer is responsible for payment of all invoices issued prior to the date of disconnection and for payment of the final invoice rendered by the Telephone Company.**

(C)

(C)

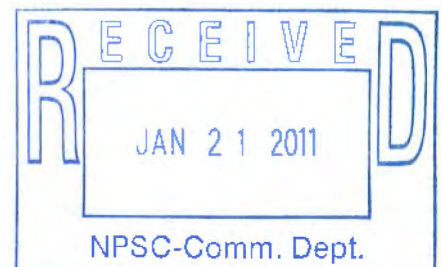

UNITED TELEPHONE COMPANY OF THE WEST - NEBRASKA d/b/a CENTURYLINK
GENERAL EXCHANGE
PRICE LIST

SECTION 3
PAGE: 5
RELEASE: 2

ISSUED: January 21, 2011

EFFECTIVE: February 1, 2011

MISCELLANEOUS SERVICES

III. SATISFACTION GUARANTEE PROGRAM (Cont'd)

B. LIMITATIONS

1. **This program is not available to customers who cancel service(s) and replace the service(s) with another service provided by the Telephone Company. This program also is not available to customers for whom installation of the Telephone Company's tariffed services required special construction or special configurations.**
2. **If the customer who cancels the service(s) provided by the Telephone Company obtains service from a local service provider, the Telephone Company will not reimburse the customer for any installation charges passed on by that provider to establish service.**
3. **Each customer will be entitled to the credit one time per service.**
4. **The Satisfaction Guarantee Program only applies to services provided under the regulations and rates specified in this Tariff and does not apply to services offered under a separately negotiated contract.**
5. **The Telephone Company is not liable for any outage, damages or inconvenience encountered by the customer when switching to an alternative local service provider.**

(C)

(C)

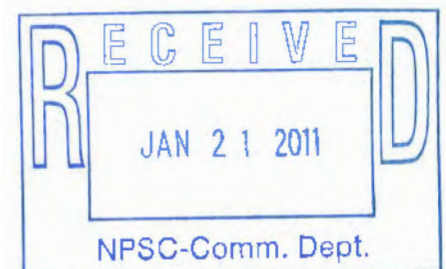

UNITED TELEPHONE COMPANY OF THE WEST - NEBRASKA
GENERAL EXCHANGE
PRICE LIST

SECTION 3

PAGE: 6

RELEASE: 2

ISSUED: August 17, 2009

EFFECTIVE: August 27, 2009

MISCELLANEOUS SERVICES

IV. VOICE BUSINESS CONTINUITY

A. GENERAL

1. Voice Business Continuity allows the subscriber to establish predetermined alternate routing plans for incoming voice traffic. Voice Business Continuity can be used as a disaster recovery service. The alternate routing plan, referred to hereafter as "Routing Plan," is created by the subscriber working with a Company representative when Voice Business Continuity is established. The Routing Plan is then loaded into the central office which serves the customer location, where it remains dormant until activated. This service is available with T1 based voice channel service such as ISDN-PRI and Digital Trunking Service.
2. The subscriber must establish a Routing Plan for each location included in the serving arrangement for which traffic is to be rerouted. The Voice Business Continuity subscriber must then contact the Company to activate the Routing Plan(s). This will route traffic to number(s) pre-selected by the Voice Business Continuity subscriber. In order to restore the original call routing, the subscriber must contact the Company to deactivate the alternate routing plan.
3. Voice Business Continuity is designed to be a disaster recovery service and is not available for routine call routing such as after hours call forwarding. The Company reserves the right to deny activation if this service is used for non-emergency situations.

B. DEFINITIONS

ARRANGEMENT

Consists of one or more Routing Plans that have been identified by the subscriber.

BACKUP NUMBER

The number that calls are rerouted to when the Routing Plan is activated.

REDIRECTED NUMBER

Any subscriber number at the customer location included in the Routing Plan for which incoming calls will be rerouted when the plan is activated.

ROUTING PLAN

The alternate call routing plan established by the subscriber that can be activated at the subscriber's request. The Routing Plan handles a maximum of five telephone numbers at one customer location. Additional Routing Plans are required for each additional customer location.

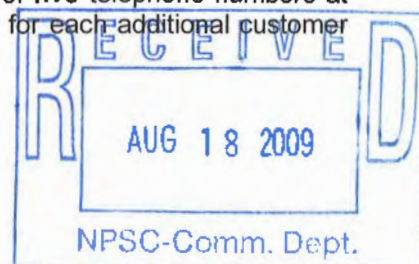

UNITED TELEPHONE COMPANY OF THE WEST - NEBRASKA
GENERAL EXCHANGE
PRICE LIST

SECTION 3
PAGE: 7
RELEASE: 1

ISSUED: June 8, 2007

EFFECTIVE: June 18, 2007

MISCELLANEOUS SERVICES

IV. VOICE BUSINESS CONTINUITY (Cont'd)

C. REGULATIONS

1. Voice Business Continuity is available where facilities or arrangements permit. The Company has the right to deny a request due to other operational priorities or the nature of the request.
2. The Voice Business Continuity subscriber must specify one or more primary points of contact and password which will be used by the Company representative to verify a request to activate, deactivate, or modify a subscriber's Routing Plan.
3. If the subscriber requests a Routing Plan with three or more Backup Numbers, requests assignment of a Redirected Number with more than one Backup Number, or requires that the Routing Plan handle more than twelve simultaneous calls to the Redirected Number, the Route Complexity Charge will apply. A Route Complexity Charge may also apply for other complex scenarios as identified by the Company. Provisioning of such requests is subject to approval of the Company and acceptance of the subscriber of the additional charge prior to provisioning by the Company.
4. A subscriber must identify one Backup Number for each Redirected Number in the Routing Plan or one Backup Number for multiple Redirected Numbers in the Routing Plan.
5. Upon request of the Voice Business Continuity subscriber, the Company will work with the subscriber to test the operation of the Routing Plan after initial establishment. Also upon request by the subscriber, the Company will test normal service before initiating recovery from an activated Routing Plan.
6. After initial establishment of the Routing Plan the subscriber may change the plan for a given location up to five times per contract year, at no charge. A Plan Update Charge will apply for all subsequent changes. Changes include, but are not limited to, adding or dropping a number or changing a Backup Number(s).
7. The Voice Business Continuity subscriber is responsible for payment of usage charges (toll, expanded local, or other) for each call routed to a subscriber location not included in the same local calling area as the original subscriber location.
8. Unless the Voice Business Continuity subscriber identifies a different Interexchange Carrier (IC) for any traffic routed to an out of LATA location, the Routing Plan will use their existing IC.
9. This service is not eligible for Suspension of Service at Request of Subscribers as specified in Section 20 of the General Exchange Tariff.

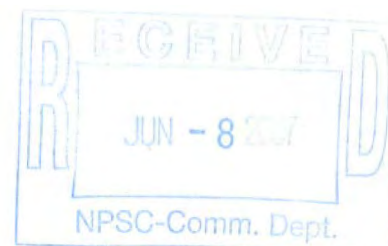

UNITED TELEPHONE COMPANY OF THE WEST - NEBRASKA
GENERAL EXCHANGE
PRICE LIST

SECTION 3
PAGE: 8
RELEASE: 1

ISSUED: June 8, 2007

EFFECTIVE: June 18, 2007

MISCELLANEOUS SERVICES

IV. VOICE BUSINESS CONTINUITY (Cont'd)

C. REGULATIONS (Cont'd)

10. Each of the Voice Business Continuity subscriber's Redirected Numbers must reside in a Company central office.
11. The Voice Business Continuity subscriber is responsible in ensuring that the Backup Number(s) have adequate facilities to support the increase in call volume.
12. The activated Routing Plan will remain active until the Voice Business Continuity subscriber requests to have original call routing restored.

D. LIMITATION OF LIABILITY

The following provisions apply in addition to the Limitation of Liability provisions specified in the General Rules and Regulations section of the General Exchange Tariff.

1. Voice Business Continuity is intended to allow a subscriber to reroute incoming calls. It may provide help during some network affecting problems, such as a cut cable between the end office and the subscriber's location by rerouting incoming calls to an alternate location. However, the Company does not guarantee the availability or reliability of Voice Business Continuity in the event of a network affecting disaster. In the event of a network affecting disaster, Voice Business Continuity may function normally, may not function at all, or it may function unpredictably depending on what part of the network is affected and how serious the affect is.
2. Activation of subscriber plans will be performed on a first come, first served basis. When the subscriber requests that Voice Business Continuity be activated, every effort will be made to activate the service as rapidly as possible. However, the length of the delay between the time that the subscriber requests activation and the time that activation actually occurs depends on a number of factors including the number of other Voice Business Continuity activations being processed when a particular request is received as well as the network load at the time the Voice Business Continuity activation command is received. In the case of an area-wide crisis, if many subscribers call at the same time to request service activation, those calling last may have a considerably longer waiting period for activation to be completed. As a result, no representation is made as to the length of time it will take to implement a particular activation request.

UNITED TELEPHONE COMPANY OF THE WEST - NEBRASKA
GENERAL EXCHANGE
PRICE LIST

SECTION 3

PAGE: 9

RELEASE: 1

ISSUED: June 8, 2007

EFFECTIVE: June 18, 2007

MISCELLANEOUS SERVICES

IV. VOICE BUSINESS CONTINUITY (Cont'd)

D. LIMITATION OF LIABILITY (Cont'd)

3. In no event shall the Company, nor its agents, be liable for any losses or damages of any kind resulting from the unavailability of its equipment or facilities or for any act, omission, or failure of performance by the Company, or its employees, or agents, in connection with this Tariff. Neither the Company, nor its agents, shall be responsible for calls that cannot be completed as a result of repair or maintenance difficulties on Company facilities and equipment, nor on equipment owned or leased by the subscriber.
4. Neither the Company, nor its agents, assume liability for any loss of revenues, increased costs, expenses, liabilities, or inconvenience experienced by the subscriber due to any unsatisfactory performance of Voice Business Continuity. Further, neither the Company, nor its agents, shall assume any liability for consequential, indirect, or incidental damages.

E. RESTRICTIONS

A Voice Business Continuity alternate routing number cannot be a subscriber Redirected Number in another active routing plan within the LATA.

F. RATES AND CHARGES

1. Application of Rates

- a. The Voice Business Continuity Nonrecurring Charge and Monthly Rate apply for each Routing Plan established by the subscriber.

UNITED TELEPHONE COMPANY OF THE WEST - NEBRASKA
GENERAL EXCHANGE
PRICE LIST

SECTION 3

PAGE: 10

RELEASE: 1

ISSUED: June 8, 2007

EFFECTIVE: June 18, 2007

MISCELLANEOUS SERVICES

IV. VOICE BUSINESS CONTINUITY (Cont'd)

F. RATES AND CHARGES (Cont'd)

1. Application of Rates (Cont'd)

- b. The Route Complexity Charge may apply as deemed by the Company and is dependent upon the complexity of the Routing Plan. Charges will be communicated to and accepted by the customer prior to establishing the Routing Plan.
- c. A Voice Business Continuity monthly rate will apply per subscriber location based on the length of customer commitment will be 12, 24, 36, and 60 months. Subscribers who terminate prior to the expiration of the commitment period will incur termination charges. Termination charges will be calculated by multiplying the number of months remaining in the commitment period times 50 percent of the applicable monthly rate for each Routing Plan prematurely disconnected.
- d. The Plan Update Charge applies for subscriber-initiated changes to a Routing Plan in excess of the five changes allowed per contract year. Also, a subscriber may incur additional charges if requested changes to the Routing Plan warrant a Route Complexity Charge.
- e. Customers who request activation of a Routing Plan within three business days of establishing the service will incur a Priority Setup Request Charge, although there is no guarantee that the Company will meet the requested date.
- f. Service Connection Charges as specified in Section 18 of the General Exchange Tariff will not apply.

UNITED TELEPHONE COMPANY OF THE WEST - NEBRASKA
GENERAL EXCHANGE
PRICE LIST

SECTION 3
PAGE: 11
RELEASE: 1

ISSUED: June 8, 2007

EFFECTIVE: June 18, 2007

MISCELLANEOUS SERVICES

IV. VOICE BUSINESS CONTINUITY (Cont'd)

F. RATES AND CHARGES (Cont'd)

2. Rates

a. Voice Business Continuity, per subscriber location

	<u>Monthly Rate</u>	<u>Nonrecurring Charge</u>
12 month rate	\$65.00	\$500.00
24 month rate	60.00	500.00
36 month rate	50.00	500.00
60 month rate	40.00	500.00

b. Priority Setup Request Charge

Nonrecurring
Charge
\$300.00

c. Route Complexity Charge

Nonrecurring
Charge
\$100.00

d. Plan Update Charge

Nonrecurring
Charge
\$100.00

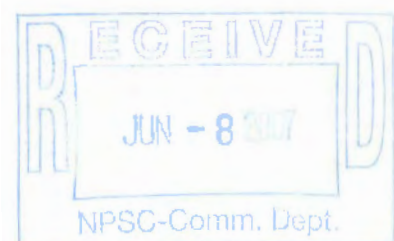

UNITED TELEPHONE COMPANY OF THE WEST – NEBRASKA d/b/a CENTURYLINK
GENERAL EXCHANGE
PRICE LIST

SECTION 3
PAGE: 12
RELEASE: 1

ISSUED: January 7, 2010

EFFECTIVE: January 17, 2010

MISCELLANEOUS SERVICES

V. RESIDENCE CUSTOMER REFERRAL PROGRAM

A. TERMS AND CONDITIONS

1. Existing residence customers may be eligible for a one-time \$50 bill credit when they submit a referral via the Company's Internet website that results in the establishment of a new customer account for service that includes residential local exchange service. This one-time \$50 bill credit will be applied to the referring customer's account within sixty days after the Company has confirmed that the referred customer has established a new customer account for service that included a residential access line. This bill credit is limited to one bill credit per customer referral and unused credits will roll over to future months. Each customer is limited to a maximum of \$600 in referral credits per calendar year.
2. New residence customers may be eligible for a \$10 bill credit for six consecutive months. To be eligible, the Company has to confirm that the referred customer has established a new customer account for service that includes residential local exchange service. The \$10 bill credits will be applied to the referred customer's account during each of the referred customer's first six bill cycles with the Company. If the referred customer discontinues the local exchange service prior to the end of the six month period, no additional credits will be applied although the referred customer will not be required to refund the Company for previously acquired bill credits.

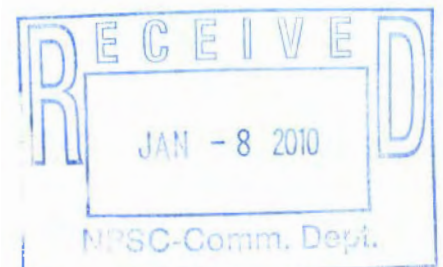

UNITED TELEPHONE COMPANY OF THE WEST – NEBRASKA d/b/a CENTURYLINK
GENERAL EXCHANGE
PRICE LIST

SECTION 3

PAGE: 13

RELEASE: 1

ISSUED: June 24, 2011

EFFECTIVE: July 6, 2011

MISCELLANEOUS SERVICES

VI. COMPETITIVE RESPONSE PROGRAMS

A. **\$5/\$10 BILL CREDIT OFFER**

Existing business customers may be eligible for consecutive bill credits when they contact the Company to inform them that they have received a better priced offer for the same or comparable service(s) from a competitor, or when they contact the Company to disconnect service(s) and agree to retain their service(s) with the Company.

To be eligible, the customer must be subscribed to any business local exchange service and must agree to retain the service(s) for one year after receiving the bill credit. Eligible customers who are subscribed to any local exchange service will receive a \$5.00 per line bill credit for six months when they agree to retain their service(s) for a minimum of twelve additional months, or will receive a \$5.00 per line bill credit for twelve months when they agree to retain their service(s) for a minimum of twenty-four additional months. Customers may receive the credits for a maximum of ten lines.

Eligible customers who are subscribed to any bundled service will receive a \$10.00 bill credit per bundle for six months when they agree to retain their bundled service(s) for a minimum of twelve additional months, or will receive a \$10.00 bill credit per bundle for twelve months when they agree to retain their service(s) for a minimum of twenty-four additional months. Customers may receive the credits for a maximum of ten bundles.

The credits will begin appearing on customer bills the first month bill following the customer's acceptance of this program. The benefits awarded under this program may not be combined with the benefits of other currently available programs or promotions.

If the customer discontinues service(s) prior to the twelve or twenty-four month commitment period, the credits issued under this promotion will be rescinded and charges for the credit amounts will be reflected on the customer's final bill. Customers are also liable for 50% of the remaining monthly recurring charges for the service(s) disconnected.

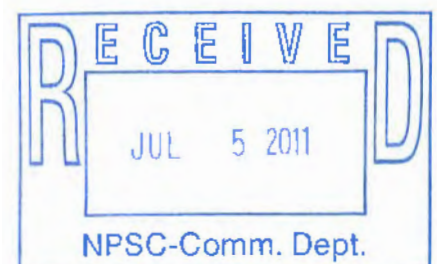

UNITED TELEPHONE COMPANY OF THE WEST – NEBRASKA d/b/a CENTURYLINK
GENERAL EXCHANGE
PRICE LIST

SECTION 3

PAGE: 14

RELEASE: 1

ISSUED: September 7, 2021

EFFECTIVE: September 18, 2021

MISCELLANEOUS SERVICES

VI. COMPETITIVE RESPONSE PROGRAMS (Cont'd)

B. SIMPLY UNLIMITED PHONE FOR RESIDENCE \$5 FOR 12 MONTHS

Beginning September 18, 2021, existing residence customers may be eligible for a \$5 bill credit for 12 months when they contact the Company to disconnect service and agree to retain service with the Company. To be eligible, the customer must agree to subscribe to the Company's Simply Unlimited Phone bundle for a minimum of 12 months. The initial bill credit will be reflected on the customer's first or second invoice following the customer's acceptance of this offer and will continue for 11 consecutive months thereafter. If a customer discontinues Simply Unlimited Phone prior to the end of the 12-month period, no additional credits will be applied. In no event will the application of this discount be used in conjunction with any other credits to take the customer's billed amount below zero.

C. SIMPLY UNLIMITED BUSINESS NRC WAIVER

Beginning September 18, 2021, Business customers may be eligible for a waiver in all applicable nonrecurring charges that otherwise apply when a new access line or key trunk is installed. To be eligible, customers must establish a new account or order a new access line. Nonrecurring charges otherwise applicable will be waived when the qualifying customer subscribes to the company's Simply Unlimited Business packaged service which includes a CenturyLink Communications, LLC unlimited long-distance plan.

UNITED TELEPHONE COMPANY OF THE WEST - NEBRASKA d/b/a CENTURYLINK
 GENERAL EXCHANGE
 PRICE LIST

(C)

Section 4

Page: 1

Release: 3

ISSUED: March 29, 2013

EFFECTIVE: April 8, 2013

DERIVED CHANNEL SERVICES

I. INDIVIDUAL VOICE CHANNELS FOR CUSTOM ACCESS SOLUTIONS

A. Description

1. Individual Voice Channels for Custom Access Solutions is an intra-exchange digital service designed to provide for the integration of multiple voice channels over Custom Access Solutions as found in **CenturyLink Operating Companies Interstate Service Guide**, Section 8.7. (T)
2. Individual Voice Channels are segregated from the data channels using a Digital Access and Cross-connect System (DACS) located in the Telephone Companies' central office. The DACS will route the voice traffic to the serving wire center switching equipment. Individual Voice Channels may be provisioned with ISDN-PRI functionality upon request.
3. Customers subscribing to Individual Voice Channels for Custom Access Solutions are limited to a maximum of 20 Individual Voice Channels per 1.544 Mbps facility. Each channel is dedicated to the provisioning of Individual Voice Channels for Custom Access Solutions. Channels not activated will not be used for purposes other than providing Individual Voice Channels for Custom Access Solutions.
4. Customers subscribing to Individual Voice Channels for Custom Access Solutions must also order data channels at the same time from **CenturyLink Operating Companies Interstate Service Guide**, Section 8.7, in one of the following combinations: (T)

Individual Voice Channels ⁽¹⁾	Frame Relay Service			
	256 Kbps (4 Channels)	384 Kbps (6 Channels)	512 Kbps (8 Channels)	768 Kbps (12 Channels)
6	10	12	14	18
8	12	14	16	20
10	14	16	18	22
12	16	18	20	24
14	18	20	22	N/A
16	20	22	24	N/A
18	22	24	N/A	N/A
20	24	N/A	N/A	N/A

Shaded area reflects total channels utilized for each combination.

5. Individual Voice Channels may be equipped with the following features, where available:
 - a. Incoming Call Identification (Caller ID) – Caller ID provides the customer with the telephone number of the calling party and is intended solely for the use of the Individual Voice Channels for Custom Access Solutions subscriber.

⁽¹⁾ A minimum of 12 Individual Voice Channels is required when provisioned with ISDN-PRI functionality and each configuration requires one D-channel. For example, when a customer subscribes to 12 Individual Voice Channels with ISDN-PRI functionality, the customer is provided with 11 B-channels and one D-channel.

MAR 28 2013

UNITED TELEPHONE COMPANY OF THE WEST - NEBRASKA d/b/a CENTURYLINK
GENERAL EXCHANGE
PRICE LIST

(C)

Section 4

Page: 2

Release: 2

ISSUED: March 29, 2013

EFFECTIVE: April 8, 2013

DERIVED CHANNEL SERVICES

I. INDIVIDUAL VOICE CHANNELS FOR CUSTOM ACCESS SOLUTIONS (Continued)

A. Description (Continued)

6. Individual Voice Channels with ISDN-PRI functionality provides functionality equivalent to ISDN-PRI Service as described in Section 1 of the General Exchange Price List. All standard features included with ISDN-PRI Service are standard for Individual Voice Channels with ISDN-PRI functionality. In addition, optional features available with ISDN-PRI Service are available with Individual Voice Channels with ISDN-PRI functionality, with the exception of D-Channel Backup and Circular Hunt. Optional features are provided at the rates and charges specified in Section 1 of the General Exchange Price List on a per 1.544 Mbps facility basis.

B. Definitions

1. Digital Access and Cross-connect System (DACCS) – A digital switching device for routing and switching T-1 lines, and DS0 portions of lines, among multiple T-1 ports. The DACCS performs all the functions of a normal "switch" except connections are typically setup in advance of the call, not together with the call.
2. Custom Access Solutions – Provides for the integration of multiple voice and data channels over the same 1.544 Mbps **facility**.

(T)

C. General Regulations

1. The regulations and rates specified herein for Individual Voice Channels for Custom Access Solutions are in addition to the applicable regulations and rates in other tariffs and other sections of this tariff. Unless specified, the regulations for Individual Voice Channels for Custom Access Solutions apply in addition to the General Regulations set forth in the General Rules and Regulations Section set forth in the General Exchange Tariff.
2. Individual Voice Channels for Custom Access Solutions is provided subject to the availability of appropriate facilities as determined by the Company. Service inquiries will be necessary to determine availability.
3. Customer Premise Equipment (CPE) that is compatible with Individual Voice Channels for Custom Access Solutions is the customer's responsibility to provision.
4. The Company shall not be responsible if changes in any of the equipment, operations or procedures of the Company utilized in the provisioning of Individual Voice Channels for Custom Access Solutions render any facilities provided by the customer obsolete or require modification or alteration of such equipment or system or otherwise affect its use or performance.
5. Individual Voice Channels for Custom Access Solutions is only available where facilities permit.

(M)

(M) Material previously found on this page now appears on Section 4, Page 3 Release 3.

25

UNITED TELEPHONE COMPANY OF THE WEST - NEBRASKA d/b/a CENTURYLINK
GENERAL EXCHANGE
PRICE LIST

(C)

SECTION 4

PAGE: 3

RELEASE: 3

ISSUED: March 29, 2013

EFFECTIVE: April 8, 2013

DERIVED CHANNEL SERVICES

I. INDIVIDUAL VOICE CHANNELS FOR CUSTOM ACCESS SOLUTIONS (Continued)

C. General Regulations (Continued)

6. Customers may disconnect Individual Voice Channels for Custom Access Solutions, without penalty, should the total of the monthly recurring rates associated with Individual Voice Channels for Custom Access Solutions increase by 10% or more at any one time. (M)
7. Custom Calling Features and ExpressTouch Features are available as specified in Section 12 of the General Exchange Price List at the applicable tariffed recurring rates. (M)
8. One Directory Listing will be provided per 1.544 Mbps facility. Additional Directory Listings are available as specified in Section 4 of the General Exchange Tariff.

D. Service Components

1. Individual Voice Channels - A monthly rate is applicable for each individual voice channels for Custom Access Solutions. Individual Voice Channels can be purchased in increments of 6, 8, 10, 12, 14, 16, 18 or 20 voice channels. Individual Voice Channels with ISDN-PRI functionality can be purchased in increments of 12, 14, 16, 18 or 20 voice channels. (T)
2. All other service components apply as specified in the **CenturyLink Operating Companies Interstate Service Guide**. (T)

E. Application of Rates

1. The monthly rate per Individual Voice Channel includes all mandatory and applicable Extended Area Service (EAS) recurring charges. Individual Voice Channels receive the same local calling area as any other form of basic local exchange service.
2. Optional toll and extended local calling plans are available as specified in this tariff at the applicable tariffed recurring rates and usage charges.
3. All federal and state surcharges apply per Individual Voice Channel, including, but not limited to, 9-1-1 surcharges and Telecommunications Relay Service (TRS) surcharges.
4. Federal monthly end user charges apply, as described in **CenturyLink Operating Companies Tariff F.C.C. No. 9**, Section 4. (e.g., End User Common Line (EUCL), Presubscribed Interexchange Carrier Charge (PICC), Line Port Charge (LPC), Federal Universal Service Fund (USF)). (T)

F. Rates and Charges

	<u>Monthly Rate (Per Channel)</u>	
1. Individual Voice Channel without ISDN-PRI functionality:	\$24.00	(T)
2. Individual Voice Channel with ISDN-PRI functionality:	\$25.00	

(M) Material now found on this page previously appeared on Section 4, Page 2 Release 1.

UNITED TELEPHONE COMPANY OF THE WEST - NEBRASKA
GENERAL EXCHANGE
PRICE LIST

SECTION 5

PAGE: 1

RELEASE: 6

ISSUED: June 16, 2009

EFFECTIVE: June 26, 2009

CENTREX SERVICE ⁽¹⁾

(T)

I. GENERAL

A. Centrex Service is an optional communications system arrangement offering central office based features similar to those found in intelligent customer premise equipment to business customers with one or more access lines within **the same** exchange. For purposes of this tariff, customers requiring more than 50 Centrex lines will be handled on an individual case basis. Centrex is offered only in those exchanges with central offices equipped to provide this service. In addition, some features may not be available in all central offices.

(C)

B. Centrex Basic Service consists of an access line, Touch-Tone capability and the features listed below:

Automatic Line	Executive Busy Override
Automatic Route Selection	Executive Busy Override-Exempt
Call Back Queuing	Expensive Route Warning Tone
Call Forwarding	Group Intercom
Call Hold	Hunt Groups
Call Park	Last Number Redial
Call Pickup	Loudspeaker and Radio Paging Access
Call Waiting	Make Set Busy
Call Waiting Exempt	Meet-Me Conference
Call Waiting Originating	Message Waiting
Code Call Access	Network Class of Service
Dial Call Waiting	Off Hook Queuing
Dictation Access and Control	Permanent Hold
Direct Inward Dialing	Ring Again
Direct Outward Dialing	Speed Calling
Directed Call Pickup Barge-In	Station Controlled Conference
Directed Call Pickup Non-Barge-In	Three-Way Conference/Call
Distinctive Ringing	Transfer Consultation Hold
	Uniform Call Distribution

Centrex Service supports all of these features; however, all features cannot be assigned to all lines. For example, when a line is assigned call busy status, it cannot be assigned Call Waiting.

⁽¹⁾ Effective October 1, 2003, Centrex Service is no longer available to new customers or existing customers whose term or contract has expired. Existing customers currently under term or contract may continue to purchase at their existing rates until their term or contract expires. Centrex Service II is available to new customers as specified in the General Exchange Price List Section 2.

(T)

JUN 16 2009

NPSC-Comm. Dept.

UNITED TELEPHONE COMPANY OF THE WEST - NEBRASKA
GENERAL EXCHANGE
PRICE LIST

SECTION 5

PAGE: 2

RELEASE: 3

ISSUED: August 14, 1997

EFFECTIVE: August 25, 1997

CENTREX SERVICE

I. GENERAL (Cont'd)

C. Centrex Meridian Service consists of an access line, Touch-Tone capability, the features listed in I.B. and the following additional features. A specialized business set with keys to activate each feature is needed with the Meridian Service package.

Meridian Auto Answer Back	Meridian Last Number Redial
Meridian Automatic Dial	Meridian Make Set Busy
Meridian Automatic Line	Meridian Malicious Call Hold
Meridian Call Back Queuing	Meridian Message Waiting
Meridian Call Forwarding	Meridian Ring Again
Meridian Call Park	Meridian Speed Calling
Meridian Call Pickup	Meridian Station Controlled
Meridian Call Waiting	Conference
Meridian Directed Call Pickup	Meridian Three-Way Conference/ Call Transfer
Non-Barge-In	Multiple Appearance Directory Number
Meridian Group Intercom	Multiple Directory Number
Meridian Intercom	

D. The following optional service is available for Centrex Basic Service, Packaged Centrex Service, Centrex Meridian Service and Packaged Meridian Centrex Service. Rates are prescribed Section IV. following, and are in addition to the Centrex Basic Service, Packaged Centrex Service, Centrex Meridian Service or Packaged Centrex Meridian Service rate.

Call Forwarding - Remote Activation

(N)

Music on Hold - Software Interface Only

II. RULES AND REGULATIONS

A. The minimum service period for Centrex Service is one (1) month except when the provision of the service requires the construction of additional facilities and/or equipment. The customer may be required to pay all or a portion of the construction and installation charges and/or contract for service beyond the minimum service period in an arrangement agreeable to both the Telephone Company and the customer.

B. A Rate Stability Plan is a payment option that allows the customer to pay a fixed monthly rate, which is not subject to rate changes, for Centrex Service over a fixed period. This plan covers the Centrex line or trunk rate, Meridian Services rate, and the Additional Numbers rate. The plan does not cover Extended Area Services rates, Service Connection Charges, Public Access Lines, or any other rates or charges not set forth in IV. below. Customers subscribing to this plan will sign a termination agreement for their service. Lines may be added to the existing contract, but the customer is subject to the terms of the agreement if a request is made to take lines out of service.

AUG 14 1997

UNITED TELEPHONE COMPANY OF THE WEST d/b/a CENTURYLINK
GENERAL EXCHANGE
PRICE LIST

SECTION 5
PAGE: 3
RELEASE: 6

ISSUED: November 30, 2018

EFFECTIVE: December 10, 2018

CENTREX SERVICE ⁽¹⁾

II. RULES AND REGULATIONS (Cont'd)

- C. Three-Way Calling, Call Forwarding and the Centrex Meridian Service are furnished subject to transmission limitation. The Telephone Company does not guarantee satisfactory transmission on such arrangements. If the customer requests additional equipment to improve transmission, and facilities permit, additional charges based upon the costs incurred may apply.
- D. Centrex Service lines may be designated as either Public Access lines or Intercommunication Only lines. Public Access lines allow access to the exchange network. Intercom Only lines allow calls to only those lines within the customer group. Through the use of a virtual facilities software package, Intercom Only lines can share access to the exchange network with the Public Access lines. The number of lines to the exchange network at anytime is limited by the number of Public Access lines ordered. Effective October 1, 1999, each Centrex Service Interconnection line will include a Public Access line allowing for access to the exchange network.
- E. Centrex Service is intended for customers utilizing single line telephone sets. Use of PBX or Key Systems in conjunction with Centrex Service is allowed only to provide connection between lines served by the existing system and other lines of the customer. The Direct Inward Dialing Feature is provided to trunk lines at the rates found in the General Exchange Price List.
- F. Centrex Service is not provided in association with Payphone Line Service.
- G. Centrex Service is not provided in association with Local Measured Service.
- H. Centrex Service is normally available for stations within an exchange only; exceptions may be made at the telephone company's discretion if facilities are available.
- I. Directory listings will be furnished in accordance with the regulations set forth in the General Exchange Tariff.
- J. The assignment of telephone numbers for the Centrex Service lines shall be in accordance with the General Rules and Regulations of the General Exchange Tariff.
- K. Telephone Company central offices with Centrex switching arrangements, providing access to Tie Lines, Foreign Exchange Lines, etc., are considered to be customer premises for the purposes of this section of the price list. (D)

⁽¹⁾ Effective October 1, 2003, Centrex Service is no longer available to new customers or existing customers whose term or contract has expired. Existing customers currently under term or contract may continue to purchase at their existing rates until their term or contract expires. Centrex Service II is available to new customers as specified in the General Exchange Price List Section 2.3.

UNITED TELEPHONE COMPANY OF THE WEST - NEBRASKA d/b/a CENTURYLINK
GENERAL EXCHANGE
PRICE LIST

(C)

SECTION 5
PAGE 4
RELEASE: 6
EFFECTIVE: April 8, 2013

ISSUED: March 29, 2013

CENTREX SERVICE⁽¹⁾

II. RULES AND REGULATIONS (Cont'd)

- L. Extended Area Service (EAS) rates found in the Local Exchange Tariff will be in addition to the Centrex Service rates for all Public Access lines in those exchanges offering EAS and will be included with the Centrex Basic Service Intercommunication Line as a single line item on the customer's bill.
- M. End User Common Line Charges will apply to all lines as prescribed by **CenturyLink Operating Companies Tariff F.C.C. No. 9.** (T)
(T)
- N. A Service Order Charge and a Central Office Line Charge per Centrex line will apply when changing service (adding or deleting lines or changing software). These charges can be found in the General Exchange Tariff.
- O. Directory Assistance charges and allowances will apply to Public Access Lines rather than the individual Centrex lines.

III. DEFINITIONS

Automatic Line - This feature provides an automatic connection between a calling station, by going off hook, and a predetermined terminating number.

Automatic Route Selection - Automatic Route Selection (ARS) allows an outgoing toll call to be automatically completed by the least cost route available. The selection of routes is determined by the customer. If the primary route is busy, the ARS feature automatically tries alternative routes as prioritized.

Call Back Queuing - Call Back Queuing allows a station user encountering an all trunks busy condition to activate the Call Back Queuing feature and hang up. When a circuit becomes idle, the system will recall the user, and when they answer, automatically place the call. Call Back Queuing only affects outgoing local trunks on an originating basis.

Call Forwarding - Call Forwarding allows a Centrex station user to have incoming calls to his station automatically forwarded to a predetermined telephone number. Four (4) types of Call Forwarding are available: Call Forward Universal, which re-routes incoming calls to another telephone number; Call Forward Intragroup, which reroutes incoming calls to only those stations within the same customer group; Call Forward Busy, which directs incoming calls to a busy station to be forwarded to a designated station or attendant; and Call Forward Don't Answer, which routes incoming calls to another designated station or attendant if the called station does not answer within a specified time. Call Forward Universal and Call Forward Intragroup are user programmable; Call Forward Busy is not.

⁽¹⁾ Effective October 1, 2003, Centrex Service is no longer available to new customers or existing customers whose term or contract has expired. Existing customers currently under term or contract may continue to purchase at their existing rates until their term or contract expires. Centrex Service II is available to new customers as specified in the General Exchange Price List Section 2.

UNITED TELEPHONE COMPANY OF THE WEST - NEBRASKA
GENERAL EXCHANGE
PRICE LIST

SECTION 5
PAGE: 5
RELEASE: 3

ISSUED: August 14, 1997

EFFECTIVE: August 25, 1997

CENTREX SERVICE

III. DEFINITIONS (Cont'd)

Call Forwarding Remote Activation - This feature permits Call Forward Universal station users who are traveling, the ability to activate, change, or deactivate their Call Forwarding service from anywhere in the town, state or country.

(N)

(N)

Call Hold - Call Hold is an optional feature available to a Centrex station user with a single set. It allows the user to hold one call for any length of time provided neither party hangs up. The user may also place other calls while a call is on hold.

Call Park - The Call Park feature allows a station to park one call against its own directory number. The parked call can be retrieved from any station within the same customer group. Once a call is parked against a directory number, the user is free to make or receive calls on that directory number.

Call Pickup - Call Pickup allows a station user to answer incoming calls to another station within a present pickup group by dialing a feature activation code.

Call Waiting - This feature allows a station user, already talking on the phone, to be informed by a tone that another call is waiting to reach the station.

Call Waiting Exempt - The Call Waiting Exempt feature prevents call waiting tones from being imposed on a station. This feature is programmed via service order.

Call Waiting Originating - Call Waiting Originating (CWO) allows an originating line to impose a call waiting tone automatically on a busy called line.

Code Call Access - This service allows stations to gain access to customer-provided code call equipment by dialing an access code and a called party code.

Dial Call Waiting - Dial Call Waiting (DCW) permits a station user to impose a call waiting tone on a busy station that normally does not have Call Waiting. DCW is similar to CWO except that DCW is applied at the discretion of the station user and CWO is applied automatically.

Dictation Access and Control - This feature provides access to customer-provided dictation recording equipment by dialing an access code. It also provides dictation equipment control functions, such as playback and correct, by transmitting Dual Tone Multi-Frequency (DTMF) signals over the voice path to the dictation recording equipment.

AUG 14 1997
NPSC-Comm. Dept.

UNITED TELEPHONE COMPANY OF THE WEST - NEBRASKA
GENERAL EXCHANGE
PRICE LIST

SECTION 5
PAGE: 6
RELEASE: 2

ISSUED: November 2, 1993

EFFECTIVE: November 12, 1993

CENTREX SERVICE

III. DEFINITIONS (Cont'd)

Direct Inward Dialing - This service allows for incoming calls from the exchange network to reach a specific station. The calling party dials the seven-digit directory number to reach the station.

Direct Outward Dialing - With this service, a Centrex station user can place external calls to the exchange network by dialing the access code (usually the digit 9), receiving an optional second dial tone, then dialing the external number.

Directed Call Pickup Barge-In - This feature is like Directed Call Pickup Non-Barge-In except Directed Call Pickup Barge-In will create a three-way call if the ringing station has been answered before completion of the pickup dialing sequence.

Directed Call Pickup Non-Barge-In - This feature permits a Centrex station user to answer a call which is ringing on a selected station within the same customer group and served by the same central office.

Distinctive Ringing - Distinctive ringing gives the Centrex station user the ability to determine whether the call is from a station within the customer group or from the exchange network by the cadence of the ringing of the phone.

Executive Busy Override - This feature allows a station user to gain access to a busy station by flashing the switchhook during busy tone and dialing a feature activation code.

Executive Busy Override-Exempt - This feature blocks the Executive Busy Override feature if another user attempts to barge-in on an existing call.

Expensive Route Warning Tone - Expensive Route Warning Tone (ERWT) is an optional feature used in conjunction with ARS that can provide a Centrex calling party a warning tone to indicate the selection of an expensive toll route.

Group Intercom - This feature allows a station abbreviated dialing to other station members within the same intercom group.

Hunt Groups - Line or station hunting provides a means of searching a number of lines to find an idle one.

RECEIVED

NOV 2 1993

COMM. & UTIL. DEPARTMENT
of Public Service Commission

(D)
(D)

UNITED TELEPHONE COMPANY OF THE WEST - NEBRASKA
GENERAL EXCHANGE
PRICE LIST

SECTION 5
PAGE: 7
RELEASE: 2

ISSUED: November 2, 1993

EFFECTIVE: November 12, 1993

CENTREX SERVICE

III. DEFINITIONS (Cont'd)

Last Number Redial - Last Number Redial allows a station user to redial his last called number by depressing one or two keys rather than the entire number.

Loudspeaker and Radio Paging Access - This feature permits Centrex station users to dial an access code to connect loudspeaker paging equipment. Access is subject to the originating station's Network Class of Service (NCOS).

Make Set Busy (MSB) - A Centrex 500/2500 station user can have the option of making the line busy to incoming calls while still completing outgoing calls. Calls attempting to terminate on a line with MSB activated can hear a busy signal or be routed to a recording.

Meet-Me Conference - A station user may set up a conference call for a special time of day with the Meet-Me Conference feature. The assigned Meet-Me Conference directory number for the conference is dialed at the designated time. Each conferee is automatically added to the conference when the Meet-Me conference number is dialed. As conferees are added, all conferees, excluding the new arrival, will receive a tone to indicate that a party has been added.

Meridian Auto Answer Back - This feature, when implemented on a specialized business set, allows any incoming call to the Primary Directory Number of the set to be automatically answered after four seconds. Conversation takes place through a hands-free unit.

Meridian Automatic Dial - This feature allows a Meridian station user to call a frequently dialed number by depressing the assigned key. The user is permitted to program and change the number.

Meridian Automatic Line - This feature is a directory number feature that may be assigned to individual directory number appearances on a specialized business set, including the primary directory number. When an off hook condition is reported from the directory number appearance, to which Automatic Line has been assigned, a connection is automatically established to a predetermined location.

RECEIVED

NOV 2 1993

AGENCY DEPARTMENT
Nebr. Public Service Commission

(D)
(D)

UNITED TELEPHONE COMPANY OF THE WEST - NEBRASKA
GENERAL EXCHANGE
PRICE LIST

SECTION 5
PAGE: 8
RELEASE: 2

ISSUED: November 2, 1993

EFFECTIVE: November 12, 1993

CENTREX SERVICE

III. DEFINITIONS (Cont'd)

Meridian Call Back Queuing - With this feature, a Meridian user encountering an all trunks busy condition has the option of being notified when a trunk becomes idle. The user is automatically connected to the called number. Meridian Call Back Queuing only affects outgoing local trunks on an originating basis.

Meridian Call Forwarding - This feature is functionally identical to Call Forwarding.

Meridian Call Park - This feature functions identically as stated under the Call Park with the following exception: The Business Set Call Park is a set feature that can be activated by either a key or an access code.

Meridian Call Pickup - Functionally the same as Call Pickup.

Meridian Call Waiting - An incoming call encountering a busy Meridian line receives audible ringing while the called station user receives call waiting notification. The called station user can choose to acknowledge the new caller and place the existing party on hold, to alternate between the caller, or to abandon one of the calls.

Meridian Directed Call Pickup Non-Barge-In - Functionally the same as Directed Call Pickup Non-Barge-In.

Meridian Group Intercom - The feature allows a Meridian user to call a member of a predesignated group using abbreviated dialing.

Meridian Intercom - This feature allows a Meridian user to call a member of a predesignated group using abbreviated dialing.

Meridian Last Number Redial - Functionally the same as Last Number Redial.

Meridian Make Set Busy - This feature allows directory number appearances, excluding private business lines and Multiple Appearance Directory Number (MADN) group members, and call terminations such as call waiting calls, camp-on and busy override, on a Meridian set to be made busy to incoming calls. (T)

Meridian Malicious Call Hold - This feature allows a Meridian subscriber to hold a connection on a malicious call, enabling the call to be traced.

RECEIVED

NOV 2 1993

ACCOUNTS RECEIVABLE DEPARTMENT
Nebr. Public Service Commission

(D)
(D)

UNITED TELEPHONE COMPANY OF THE WEST - NEBRASKA
GENERAL EXCHANGE
PRICE LIST

SECTION 5
PAGE: 9
RELEASE: 2

ISSUED: November 2, 1993

EFFECTIVE: November 12, 1993

CENTREX SERVICE

III. DEFINITIONS (Cont'd)

Meridian Message Waiting - This feature permits a Meridian user to dial a code to access the person who activated the Message Waiting feature. With the Meridian capability, an LCD lamp will be activated when a message is waiting.

Meridian Ring Again - This feature is functionally like Ring Again but is classified as a set feature requiring assignment to a specific key and associated LCD indicator.

Meridian Speed Calling - This feature allows a Meridian user to access two different speed call lists by pressing Speed Call keys or dialing speed call access codes.

Meridian Station Controlled Conference - A specialized business set with this feature assigned can establish a conference call of up to thirty (30) parties. Any of the other parties may be external to the switch.

Meridian Three-Way Conference/Call Transfer - This feature allows a Meridian user to include a third party in the call and then optionally transfer the call to the third party.

Message Waiting - This feature permits a station user to dial a code to access the person who activated the Message Waiting feature. It also permits the station to activate Message Waiting for another station. Stuttered dial tone will also be used to inform users that a message is waiting for them.

Multiple Appearance Directory Number - A directory number that is assigned to more than one specialized business set or single line set is called a Multiple Appearance Directory Number (MADN). The telephone sets that are assigned this number are known as a MADN group. MADN groups can be comprised of 2 to 32 stations and configured in either single call arrangements or multiple call arrangements.

Multiple Directory Number - An optional feature that allows a single Centrex line to have telephone numbers associated to the primary directory number while allowing only one call path.

Music on Hold - Software Interface - An optional feature that provides for music to be played to a caller while he/she is placed on hold. The music source is provided by the subscriber, and requires an additional Centrex line to carry the music to the central office.

RECEIVED

NOV 2 1993

ACCOUNTS DEPARTMENT
Nebr. Public Service Commission

(N)
|
(N)

(D)
(D)

UNITED TELEPHONE COMPANY OF THE WEST d/b/a CENTURYLINK
GENERAL EXCHANGE
PRICE LIST

SECTION 5

PAGE: 10

RELEASE: 4

ISSUED: November 30, 2018

EFFECTIVE: December 10, 2018

CENTREX SERVICE*

III. DEFINITIONS (Cont'd)

Network Class of Service - The Network Class of Service (NCOS) feature in the Centrex system defines the specific features and calling patterns available to individual stations and attendants within a customer group. Access code restrictions can be set up to restrict stations and attendants from trunk types such as local, toll, and DID. Also the ability to use certain features like Network Speed Call, Call Back Queuing and Off Hood Queuing are assigned by NCOS. (D)

Off Hook Queuing - Off Hook Queuing - enables a call that cannot be completed because no outgoing trunk is available to wait off hook in queue for an idle trunk. Once a trunk is available, the call progresses normally.

Permanent Hold - The Permanent Hold option allows a Centrex station user to put an active call on hold and return the handset to the cradle.

Ring Again - A station user encountering a busy directory number can choose to be notified when the busy station becomes idle and automatically re-access that same number using the Ring Again feature. Both stations must be in the same customer group and be served by the same central office.

Speed Calling - Speed Calling - allows a user to place calls to a list of frequently called numbers by dialing a speed call activation code instead of dialing the complete number. The speed call numbers are programmed by the individual users at their stations. A speed dial number may be a directory number, authorization code, account code, access code or feature access code. Speed Call Lists of 30 to 70 numbers can be shared. Ten (10) number Speed Call Lists are private and cannot be shared.

Station Controlled Conference - This feature allows a 500/2500 Centrex station user to establish a conference call consisting of six parties.

Three-Way Conference/Call Transfer/Consultation Hold - This feature allows an Centrex station user to call a third party to conference him in, notify him of a call being transferred or consult with him while the other party is on hold.

Uniform Call Distribution - The Uniform Call Distribution (UCD) feature allows for an even distribution of incoming calls to a listed directory number answered by a group of 500/2500 stations. This group of stations is called an UCD group. Each station has its own directory number and is assigned the UCD feature.

* Effective October 1, 2003, Centrex Service is no longer available to new customers or existing customers whose term or contract has expired. Existing customers currently under term or contract may continue to purchase at their existing rates until their term or contract expires. Centrex Service II is available to new customers as specified in the General Exchange Price List Section 2.

UNITED TELEPHONE COMPANY OF THE WEST - NEBRASKA
GENERAL EXCHANGE
PRICE LIST

SECTION 5
PAGE: 11
RELEASE: 8

ISSUED: December 30, 2008

EFFECTIVE: January 9, 2009

CENTREX SERVICE ⁽¹⁾

(T)

IV. RATES

A. Centrex Basic Service Intercommunication Lines

	<u>36 Month Rate Stable</u>	<u>60 Month Rate Stable</u>	
4-50 lines, each ⁽²⁾		\$15.25	(T)
2-50 lines, each ⁽³⁾	\$26.00	\$24.00	(T)

⁽²⁾ Limited to existing customers at existing locations as of October 1, 1999 for the term of the Rate Stability Plan. (T)

⁽³⁾ Intercommunication line includes access to the Public Network. Rates are based on quantities for single location service. (T)

B. The Centrex trunk additive of **\$4.18** will be applied to the trunk rates found in the Local Exchange Tariff, for all Centrex lines terminating in multi-line equipment (e.g., key and PBX systems). The line rate is for Centrex lines terminating in single line instruments. (I)

C. The rates applying to Centrex Meridian Service will be the same as those for Centrex Basic Service plus the Meridian Service rate of **\$3.85** per line. (I)

D. The number of lines to the exchange network for a customer at any one time is limited by the number of Public Access Lines ordered. Add **\$5.50** to the intercom line rate for each Public Access Line ordered prior to October 1, 1999. Extended Area Service rates also apply to each Public Access Line where applicable. Info-Link Service found in Section 28 is available on a per Public Access Line (PAL) basis and must be purchased for each PAL within a Centrex customer group. (I)

E. For each Multiple Appearance Directory Number, terminating on one key in a Meridian Services instrument, an Additional Number rate of **\$0.83** shall be applied. Each Multiple Appearance Directory Number must appear as a primary intercom line on one Centrex station. (I)

I. CC Comm t.

⁽¹⁾ Effective October 1, 2003, Centrex Service is no longer available to new customers or existing customers whose term or contract has expired. Existing customers currently under term or contract may continue to purchase at their existing rates until their term or contract expires. Centrex Service II is available to new customers as specified in the General Exchange Price List Section 2. (T)

UNITED TELEPHONE COMPANY OF THE WEST - NEBRASKA
GENERAL EXCHANGE
PRICE LIST

SECTION 5
PAGE: 12
RELEASE: 8

ISSUED: June 16, 2009

EFFECTIVE: June 26, 2009

CENTREX SERVICE ⁽¹⁾

IV. RATES (Cont'd)

F. Meridian sets can support private business lines which shall be offered at the current Business **Individual Line** rate specified in the Local Exchange Tariff. (T)

G. Music on Hold rates are applicable as follows:

<u>Line Size</u>	<u>Interface Only</u> ⁽²⁾
1-20 Lines	\$16.50
21-50 Lines	22.00

H. For each Multiple Directory Number terminating on one key on a Meridian set, an Additional Number rate of \$0.83 shall be applied. In addition, rates for number block assignments in increments of 10 are applicable, and can be found in the section containing Direct Inward Dialing.

I. Call Forwarding - Remote Activation is available at \$4.00 per line, per month. The Call Forwarding-Remote Activation customer is responsible for all toll calls when the forward-to number is outside the local calling area. (FCG1FAB)

J. Other rates found in this price list or the General Exchange Tariff may also be applicable.

⁽¹⁾ Effective October 1, 2003, Centrex Service is no longer available to new customers or existing customers whose term or contract has expired. Existing customers currently under term or contract may continue to purchase at their existing rates until their term or contract expires. Centrex Service II is available to new customers as specified in the General Exchange Price List Section 2.

⁽²⁾ An additional Centrex line is necessary for this service at the rate designated in IV.A above.

JUN 16 2009

UNITED TELEPHONE COMPANY OF THE WEST - NEBRASKA
GENERAL EXCHANGE
PRICE LIST

SECTION 6
PAGE: 1
RELEASE: 1

ISSUED: November 16, 1992

EFFECTIVE: November 26, 1992

RESERVED FOR FUTURE USE

RECEIVED

NOV 16 1992

**ACCT. & ENCL. DEPARTMENT
Nebr. Public Service Commission**

UNITED TELEPHONE COMPANY OF THE WEST - NEBRASKA
GENERAL EXCHANGE
PRICE LIST

SECTION 7
PAGE: 1
RELEASE: 1

ISSUED: November 16, 1992

EFFECTIVE: November 26, 1992

RESERVED FOR FUTURE USE

RECEIVED

NOV 16 1992

ACCT. & ENCL. DEPARTMENT
Nebr. Public Service Commission

UNITED TELEPHONE COMPANY OF THE WEST - NEBRASKA
GENERAL EXCHANGE
PRICE LIST

SECTION 8
PAGE: 1
RELEASE: 1

ISSUED: November 16, 1992

EFFECTIVE: November 26, 1992

RESERVED FOR FUTURE USE

RECEIVED

NOV 16 1992

ACCT. & ENCL. DEPARTMENT
Nebr. Public Service Commission

UNITED TELEPHONE COMPANY OF THE WEST - NEBRASKA d/b/a CENTURYLINK
GENERAL EXCHANGE
PRICE LIST

(C)

SECTION 9
PAGE: 1
RELEASE: 2

ISSUED: July 9, 2015

EFFECTIVE: July 20, 2015

RESERVED FOR FUTURE USE

(T)

(D)

(D)

NE 15-07

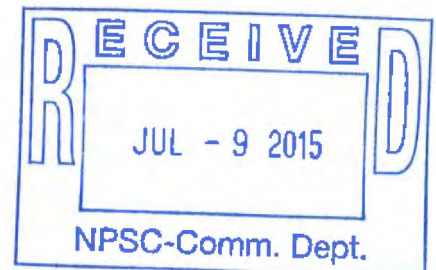

UNITED TELEPHONE COMPANY OF THE WEST – NEBRASKA d/b/a CENTURYLINK
GENERAL EXCHANGE
PRICE LIST

(C)

SECTION 9
PAGE: 2
RELEASE: 3

ISSUED: July 9, 2015

EFFECTIVE: July 20, 2015

RESERVED FOR FUTURE USE

(T)

(D)

NE 15-07

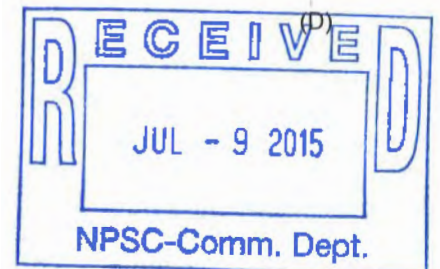

UNITED TELEPHONE COMPANY OF THE WEST -- NEBRASKA d/b/a CENTURYLINK
GENERAL EXCHANGE
PRICE LIST

(C)

SECTION 9
PAGE: 3
RELEASE: 4

ISSUED: July 9, 2015

EFFECTIVE: July 20, 2015

RESERVED FOR FUTURE USE

(T)

(D)

NE 15-07

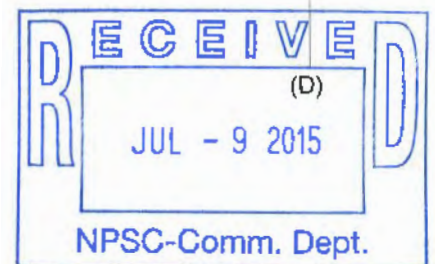

UNITED TELEPHONE COMPANY OF THE WEST – NEBRASKA d/b/a CENTURYLINK
GENERAL EXCHANGE
PRICE LIST

(C)

SECTION 9
PAGE: 4
RELEASE: 4

ISSUED: July 9, 2015

EFFECTIVE: July 20, 2015

RESERVED FOR FUTURE USE

(T)

(D)

NE 15-07

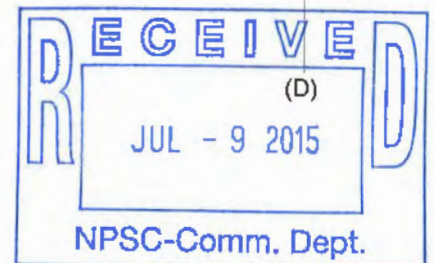

UNITED TELEPHONE COMPANY OF THE WEST - NEBRASKA d/b/a CENTURYLINK
GENERAL EXCHANGE
PRICE LIST

(C)

SECTION 9
PAGE: 4.1
RELEASE: 3

ISSUED: July 9, 2015

EFFECTIVE: July 20, 2015

RESERVED FOR FUTURE USE

(T)

(D)

NE 15-07

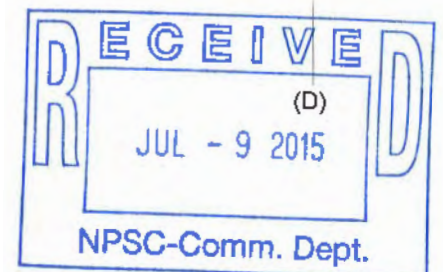

UNITED TELEPHONE COMPANY OF THE WEST - NEBRASKA d/b/a CENTURYLINK
GENERAL EXCHANGE
PRICE LIST

(C)

SECTION 9

PAGE: 5

RELEASE: 4

ISSUED: July 9, 2015

EFFECTIVE: July 20, 2015

RESERVED FOR FUTURE USE

(T)

(D)

(D)

NE 15-07

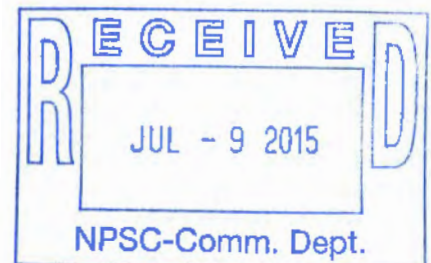

UNITED TELEPHONE COMPANY OF THE WEST - NEBRASKA d/b/a CENTURYLINK
GENERAL EXCHANGE
PRICE LIST

SECTION 9
PAGE: 6
RELEASE: 6
EFFECTIVE: July 20, 2015

ISSUED: July 9, 2015

RESERVED FOR FUTURE USE

(T)

(D)

(D)

NE 15-07

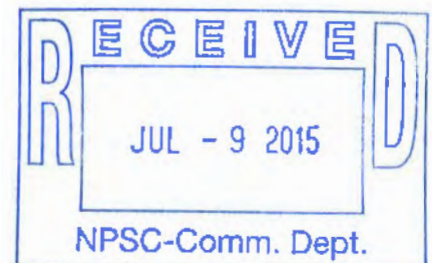

UNITED TELEPHONE COMPANY OF THE WEST – NEBRASKA d/b/a CENTURYLINK
GENERAL EXCHANGE
PRICE LIST

(C)

SECTION 9

PAGE: 7

RELEASE: 4

ISSUED: July 9, 2015

EFFECTIVE: July 20, 2015

RESERVED FOR FUTURE USE

(T)

(D)

(D)

NE 15-07

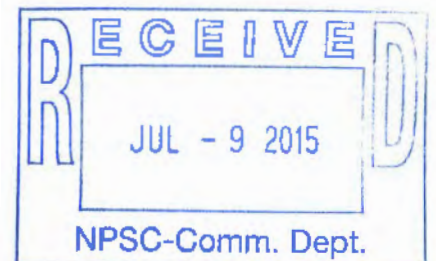

UNITED TELEPHONE COMPANY OF THE WEST – NEBRASKA d/b/a CENTURYLINK (C)
GENERAL EXCHANGE
PRICE LIST

SECTION 9

PAGE: 8

RELEASE: 3

ISSUED: July 9, 2015

EFFECTIVE: July 20, 2015

RESERVED FOR FUTURE USE

(T)

(D)

NE 15-07

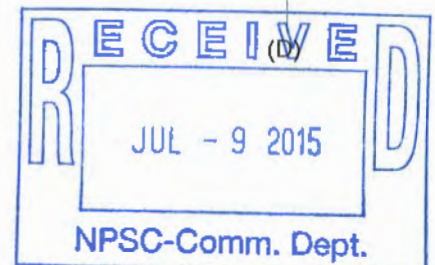

UNITED TELEPHONE COMPANY OF THE WEST – NEBRASKA d/b/a CENTURYLINK (C)
GENERAL EXCHANGE
PRICE LIST

SECTION 9
PAGE: 9
RELEASE: 4

ISSUED: July 9, 2015

EFFECTIVE: July 20, 2015

RESERVED FOR FUTURE USE

(T)

(D)

(D)

NE 15-07

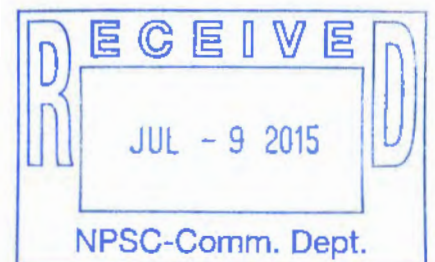

UNITED TELEPHONE COMPANY OF THE WEST – NEBRASKA d/b/a CENTURYLINK
GENERAL EXCHANGE
PRICE LIST

(C)

SECTION 9
PAGE: 10
RELEASE: 2

ISSUED: July 9, 2015

EFFECTIVE: July 20, 2015

RESERVED FOR FUTURE USE

(T)

(D)

(D)

NE 15-07

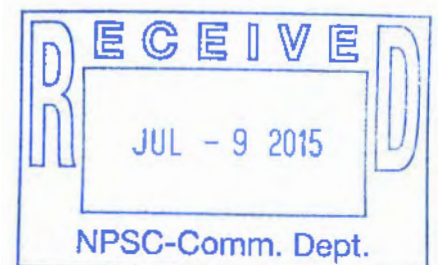

UNITED TELEPHONE COMPANY OF THE WEST – NEBRASKA d/b/a CENTURYLINK
GENERAL EXCHANGE
PRICE LIST

(C)

SECTION 9
PAGE: 11
RELEASE: 5

ISSUED: July 9, 2015

EFFECTIVE: July 20, 2015

RESERVED FOR FUTURE USE

(T)

(D)

(D)

NE 15-07

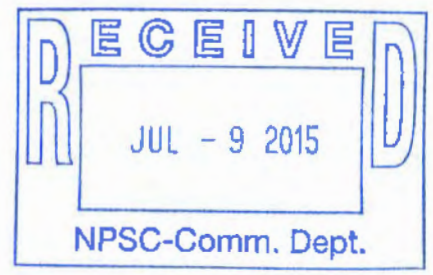

UNITED TELEPHONE COMPANY OF THE WEST – NEBRASKA d/b/a CENTURYLINK
GENERAL EXCHANGE
PRICE LIST

(C)

SECTION 9
PAGE: 12
RELEASE: 3

ISSUED: July 9, 2015

EFFECTIVE: July 20, 2015

RESERVED FOR FUTURE USE

(T)

(D)

(D)

NE 15-07

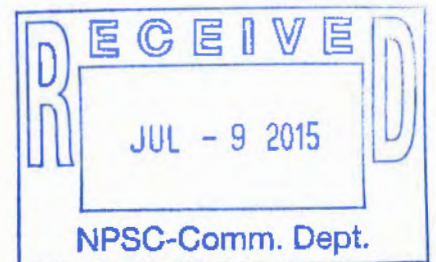

UNITED TELEPHONE COMPANY OF THE WEST – NEBRASKA d/b/a CENTURYLINK
GENERAL EXCHANGE
PRICE LIST

(C)

SECTION 9
PAGE: 13
RELEASE: 3

ISSUED: July 9, 2015

EFFECTIVE: July 20, 2015

RESERVED FOR FUTURE USE

(T)

(D)

NE 15-07

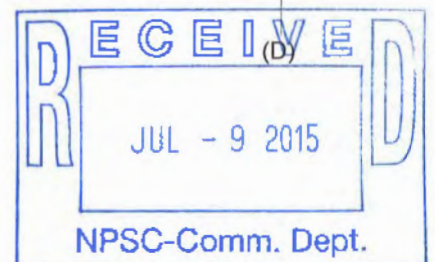

UNITED TELEPHONE COMPANY OF THE WEST - NEBRASKA d/b/a CENTURYLINK
GENERAL EXCHANGE
PRICE LIST

(C)

SECTION 9
PAGE: 14
RELEASE: 4

ISSUED: July 9, 2015

EFFECTIVE: July 20, 2015

RESERVED FOR FUTURE USE

(T)

(D)

NE 15-07

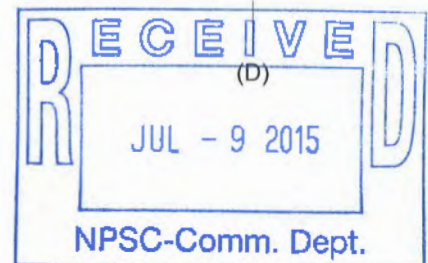

UNITED TELEPHONE COMPANY OF THE WEST – NEBRASKA d/b/a CENTURYLINK
GENERAL EXCHANGE
PRICE LIST

(C)

ISSUED: July 9, 2015

SECTION 9
PAGE: 14.1
RELEASE: 3
EFFECTIVE: July 20, 2015

RESERVED FOR FUTURE USE

(T)

(D)

NE 15-07

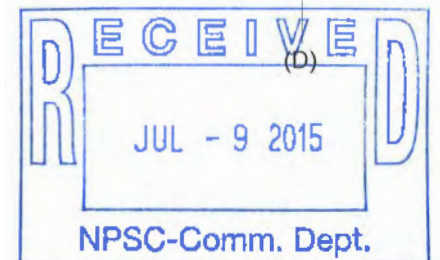

UNITED TELEPHONE COMPANY OF THE WEST – NEBRASKA d/b/a CENTURYLINK
GENERAL EXCHANGE
PRICE LIST

(C)

SECTION 9
PAGE: 15
RELEASE: 3
EFFECTIVE: July 20, 2015

ISSUED: July 9, 2015

RESERVED FOR FUTURE USE

(T)

(D)

NE 15-07

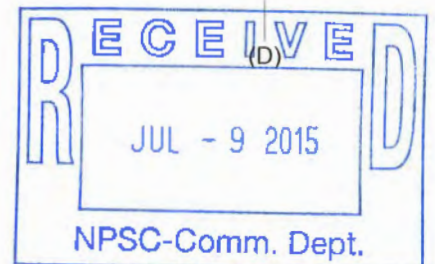

UNITED TELEPHONE COMPANY OF THE WEST – NEBRASKA d/b/a CENTURYLINK
GENERAL EXCHANGE
PRICE LIST

(C)

SECTION 9
PAGE: 16
RELEASE: 2
EFFECTIVE: July 20, 2015

ISSUED: July 9, 2015

RESERVED FOR FUTURE USE

(T)

(D)

NE 15-07

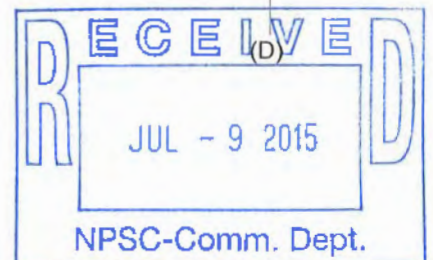

UNITED TELEPHONE COMPANY OF THE WEST - NEBRASKA d/b/a CENTURYLINK (C)
GENERAL EXCHANGE
PRICE LIST

SECTION 9
PAGE: 17
RELEASE: 5
EFFECTIVE: July 20, 2015

ISSUED: July 9, 2015

RESERVED FOR FUTURE USE

(T)

(D)

NE 15-07

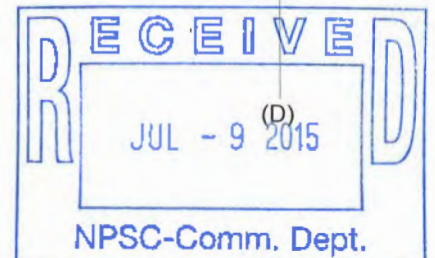

UNITED TELEPHONE COMPANY OF THE WEST – NEBRASKA d/b/a CENTURYLINK (C)
GENERAL EXCHANGE
PRICE LIST

SECTION 9
PAGE: 18
RELEASE: 5
EFFECTIVE: July 20, 2015

ISSUED: July 9, 2015

RESERVED FOR FUTURE USE (T)

(D)

NE 15-07

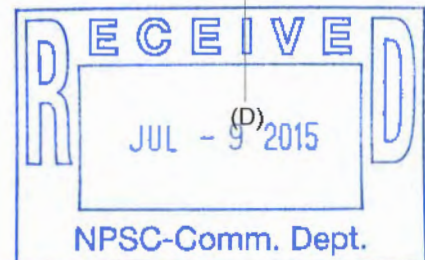

UNITED TELEPHONE COMPANY OF THE WEST – NEBRASKA d/b/a CENTURYLINK
GENERAL EXCHANGE
PRICE LIST

(C)

ISSUED: July 9, 2015

SECTION 9
PAGE: 19
RELEASE: 5
EFFECTIVE: July 20, 2015

RESERVED FOR FUTURE USE

(T)

(D)

NE 15-07

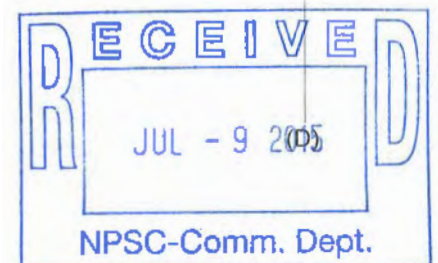

UNITED TELEPHONE COMPANY OF THE WEST – NEBRASKA d/b/a CENTURYLINK
GENERAL EXCHANGE
PRICE LIST

(C)

SECTION 9
PAGE: 20
RELEASE: 5

ISSUED: July 9, 2015

EFFECTIVE: July 20, 2015

RESERVED FOR FUTURE USE

(T)

(D)

NE 15-07

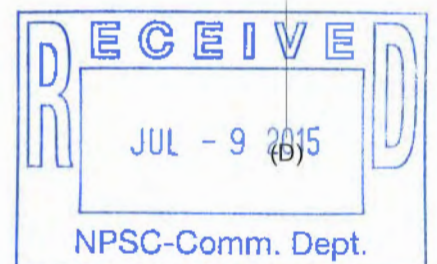

UNITED TELEPHONE COMPANY OF THE WEST – NEBRASKA d/b/a CENTURYLINK
GENERAL EXCHANGE
PRICE LIST

(C)

ISSUED: July 9, 2015

SECTION 9
PAGE: 21
RELEASE: 5
EFFECTIVE: July 20, 2015

RESERVED FOR FUTURE USE

(T)

(D)

NE 15-07

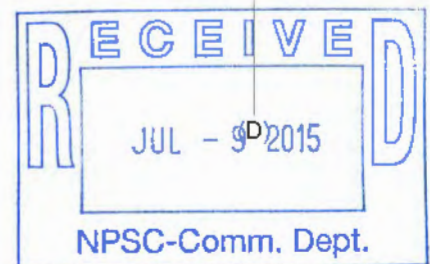

UNITED TELEPHONE COMPANY OF THE WEST – NEBRASKA d/b/a CENTURYLINK
GENERAL EXCHANGE
PRICE LIST

(C)

SECTION 9
PAGE: 22
RELEASE: 2

ISSUED: July 9, 2015

EFFECTIVE: July 20, 2015

RESERVED FOR FUTURE USE

(D)

NE 15-07

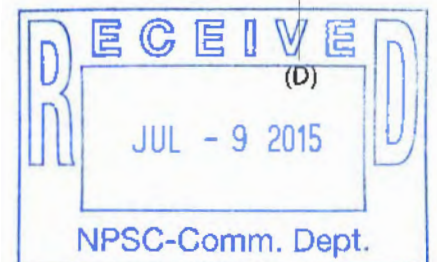

UNITED TELEPHONE COMPANY OF THE WEST – NEBRASKA d/b/a CENTURYLINK
GENERAL EXCHANGE
PRICE LIST

(C)

SECTION 9
PAGE: 23
RELEASE: 2

ISSUED: July 9, 2015

EFFECTIVE: July 20, 2015

RESERVED FOR FUTURE USE

(T)

(D)

NE 15-07

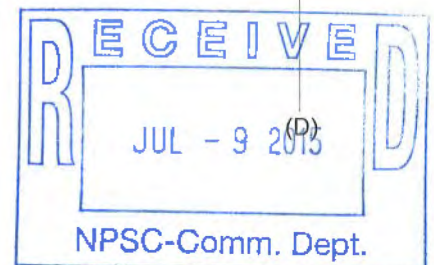

UNITED TELEPHONE COMPANY OF THE WEST – NEBRASKA d/b/a CENTURYLINK (C)
GENERAL EXCHANGE
PRICE LIST

SECTION 9

PAGE: 24

RELEASE: 2

EFFECTIVE: July 20, 2015

ISSUED: July 9, 2015

RESERVED FOR FUTURE USE

(T)

(D)

NE 15-07

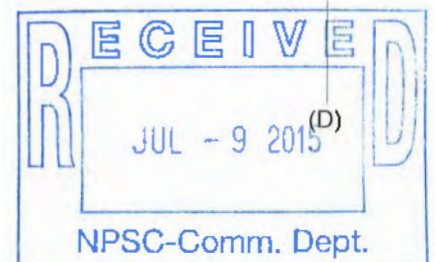

UNITED TELEPHONE COMPANY OF THE WEST - NEBRASKA
GENERAL EXCHANGE
PRICE LIST

SECTION 10
PAGE: 1
RELEASE: 1

ISSUED: November 30, 1992

EFFECTIVE: December 10, 1992

RESERVED FOR FUTURE USE

RECEIVED

NOV 30 1992

ACCT. & ENCL. DEPARTMENT
Nebr. Public Service Commission

UNITED TELEPHONE COMPANY OF THE WEST d/b/a CenturyLink
NEBRASKA
GENERAL EXCHANGE PRICE LIST

SECTION 11
INDEX PAGE: 1
RELEASE: 8

ISSUED: June 20, 2013

EFFECTIVE: July 2, 2013

SUPPLEMENTAL SERVICES

<u>CONTENTS</u>	<u>PAGE</u>	
Maintenance of Service (a.k.a. Trouble Isolation Charge) (Customer Provided Equipment)....	2	(T)
Subscriber Transfer Service.....	3	
Touch-Tone Service.....	3	
Rotary Hunt Service.....	4	
Customer Convenience Calling	5	
Toll and Casual Dialing Restriction Service.....	6	
Direct Inward Dialing Service (DID)	8	
900 Service Access Restriction	1	
Bill Number Screening	10	
Special Monthly Billing.....	11	
Call Line Identifier	12	

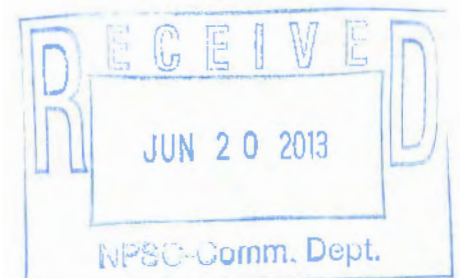

UNITED TELEPHONE COMPANY OF THE WEST d/b/a CenturyLink
NEBRASKA
GENERAL EXCHANGE PRICE LIST

SECTION 11

PAGE: 2

RELEASE: 7

EFFECTIVE: March 1, 2022

ISSUED: February 17, 2022

SUPPLEMENTAL SERVICES

B. Maintenance of Service Charge (a.k.a. Trouble Isolation Charge)

1. General

The Trouble Isolation Charge is applicable when the Company dispatches a technician to investigate a customer-reported trouble and a service difficulty is found to be caused by customer-provided equipment, wire, facilities, communications system or customer actions, and the customer does not have the Company repair the premises wire trouble.

The Trouble Isolation Charge also applies when a customer requests or allows the Company to dispatch a technician to investigate the reported trouble and the customer then does not allow access to the necessary in-home wiring and equipment or is not available to allow access.

This charge is waived for customers who have inside wire protection, unless the Company determines through remote testing that no trouble exists, and the customer insists on a dispatch. If no trouble is found, a Trouble Isolation Charge applies whether or not the customer has inside wire protection.

The Trouble Isolation Charge will not apply when:

- Customer is subscribed to an Inside Wire Maintenance Plan before a Company technician is dispatched.
- A service difficulty or trouble is found to be in a permanently wired telephone associated with service (i.e., no network interface device).
- The service difficulty or trouble is in Company-maintained equipment or wiring
- No trouble is found after customer allows the necessary access to in-home wiring and/or equipment.
- Customer authorizes company repair of inside wiring and/or customer-provided equipment.

2. Charges

Per Maintenance Service Call Charge **\$99.00 (I)**

UNITED TELEPHONE COMPANY OF THE WEST - NEBRASKA
GENERAL EXCHANGE
PRICE LIST

SECTION 11

PAGE: 3

RELEASE: 2

ISSUED: June 16, 2009

EFFECTIVE: June 26, 2009

SUPPLEMENTAL SERVICES

C. SUBSCRIBER TRANSFER SERVICE ⁽¹⁾ (T)

1. Where it is desired to automatically transfer incoming calls from one telephone line to another telephone line, it requires a transfer key, a transfer circuit at the Telephone Company Central Office, and same frequency ringers in both telephones. Both lines must be **individual lines**. This service is not available in exchanges served by digital central offices. (T)

2. Rate

	<u>Installation Charge</u>	<u>Monthly Rate</u>	
Transfer (AAASBTR)	(2)	\$1.10	(T)

3. If the telephone line to which the calls are to be transferred is not under contract by the subscriber requesting this service, the Telephone Company may demand written consent from the other subscriber before this service can be provided. (D)

D. TOUCH-TONE (T)

1. Push button used in lieu of a dial for calling other telephone numbers.
2. Available only where the switchboard, or switching unit, with which the equipment is connected is equipped for Touch-Tone calling.

⁽¹⁾ This service was formerly called "Transfer of Call Service."

⁽²⁾ Service Connection Charges where applicable.

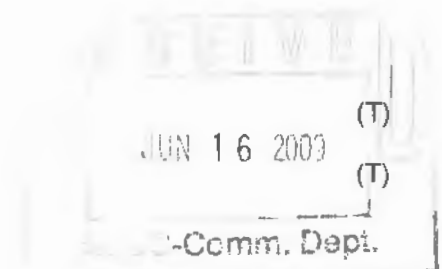

UNITED TELEPHONE COMPANY OF THE WEST - NEBRASKA
GENERAL EXCHANGE
PRICE LIST

SECTION 11

PAGE: 4

RELEASE: 7

ISSUED: March 1, 2016

EFFECTIVE: June 1, 2016

SUPPLEMENTAL SERVICES

E. Rotary Hunt Service ⁽¹⁾

1. A type of service which provides access to two or more business or residence lines or trunks of a customer when the primary listed telephone number is dialed.

	Installation Charge	Monthly Rate		
		Rate Group 1	Rate Group 2	Rate Group 3
Per Business Line or Trunk	(2)	\$0.00 (R)	\$0.00 (R)	\$0.00
Per Residence Line or Trunk ⁽¹⁾	(2)	2.00	2.00	2.00

⁽¹⁾ Effective June 5, 2009, Rotary Hunt Service is limited to existing residence customers at existing locations.

⁽²⁾ Service Connection Charges where applicable.

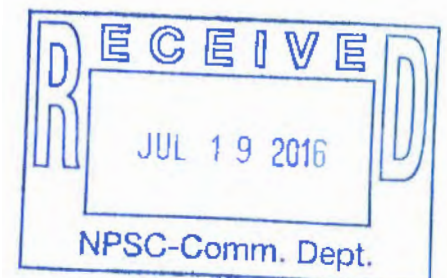

UNITED TELEPHONE COMPANY OF THE WEST - NEBRASKA
 GENERAL EXCHANGE
 PRICE LIST

SECTION 11
 PAGE: 5
 RELEASE: 6
 EFFECTIVE: June 26, 2009

ISSUED: June 16, 2009

SUPPLEMENTAL SERVICES

F. CUSTOMER CONVENIENCE CALLING (SELECTIVE CLASS OF CALL SCREENING) ⁽¹⁾ (T)

1. General

Customer Convenience Calling Service which includes Selective Class of Call Screening and Toll Restriction enables a customer, by means of Telephone Company operator identification, to restrict outgoing toll calls from station users and prohibits the charging of calls to the number via third number or collect. Toll calls originating from the customer's line can only be charged to a calling card, third number or sent collect.

All local calls, calls to the operator, calls to Telephone Company numbers such as repair service, Directory Assistance service, and public emergency service numbers, such as 911, will be permitted.

This service may be provided to hospitals, hotel/motels, college and university dormitories and other businesses and institutions where facilities permit.

- a. Lifeline subscribers may receive, Selective Class of Call Screening and Toll Restriction without paying a monthly rate or installation charge.

Selective Class of Call Screening and Toll Restriction available with Payphone Line Service is specified in Section 15 of the General Exchange Tariff.

2. Rates

These rates and charges are in addition to the established monthly and non-recurring charges applicable to services or equipment associated with Customer Convenience Calling service.

	Monthly Rate		Installation Charge
	<u>Residence</u>	<u>Business</u>	
a. Customer Convenience Calling Service - includes Selective Class of Call Screening and Toll Restriction	\$5.00	\$5.00	(2)
b. Selective Class of Call Screening only	\$3.00	\$3.00	(2)
c. Toll Restriction only	\$4.00	\$4.00	(2)

⁽¹⁾ Limited to existing customers at existing locations as of May 1, 2009.

⁽²⁾ Service Connection Charges where applicable.

UNITED TELEPHONE COMPANY OF THE WEST - NEBRASKA
GENERAL EXCHANGE
PRICE LIST

SECTION 11

PAGE: 6

RELEASE: 5

ISSUED: June 16, 2009

EFFECTIVE: June 26, 2009

SUPPLEMENTAL SERVICES

G. TOLL AND CASUAL DIALING RESTRICTION SERVICE

(T)

1. Description

- a. Where central office facilities permit, Toll and Casual Dialing Restriction prevents the completion of certain types of calls. Toll and Casual Dialing Restriction may be provided with individual line residence and business exchange services in exchanges equipped to program Toll and Casual Dialing Restriction without alteration of the central office equipment.

2. Terms and Conditions

- a. Toll and Casual Dialing Restriction Options 1 and 2 restrict access to 1+, 0+ 0-, and 00-, and restrict access to 01/011+ numbers outside of the North American Numbering Plan. Access to 900, 976, 500 and 700 numbers is also restricted in addition to Directory Assistance and the casual dialing of toll calls (by preceding the telephone number with 101XXXX+). Option 1 additionally restricts access to Toll Free Code numbers.
- b. Restriction of access to operator services prevents the customer from dialing an operator for all purposes, including emergencies, assistance and the placing of toll calls. Operator Services will not be accessible from a line with Toll and Casual Dialing Restriction Option 1 or 2. The customer indemnifies and saves harmless the Company from any and all claims, losses, or damages caused by restriction of access to operator services.
- c. Directory Assistance (411, 1411, 555-1212, 1-555-1212, or 1-NPA-555-1212) and directory assistance call completion (DACC) will not be accessible from a line with Toll and Casual Dialing Restriction Option 1 or 2.
- d. All local calls and non-chargeable calls to Company numbers (such as repair service) will be permitted.
- e. Where facilities allow, N11 (except 411) will only be restricted with Option 1 and 2 if the call terminates outside the local calling area or to a non-toll-free number.
- f. Toll and Casual Dialing Restriction does not restrict calls to 911 emergency reporting service or to 1+710 Government Emergency Telecommunications Service Calls.
- g. Customers are responsible for calls charged to their number via third number billing, collect or credit card.

UNITED TELEPHONE COMPANY OF THE WEST - NEBRASKA
GENERAL EXCHANGE
PRICE LIST

SECTION 11

PAGE: 7

RELEASE: 6

ISSUED: June 16, 2009

EFFECTIVE: June 26, 2009

SUPPLEMENTAL SERVICES

G. TOLL AND CASUAL DIALING RESTRICTION SERVICE (Cont'd)

(T)

2. Terms and Conditions (Cont'd)

- h. Lifeline subscribers may receive Toll and Casual Dialing Restriction without paying a monthly or non-recurring charge.
- i. Listed following are the Toll and Casual Dialing Restriction options as determined by the Company. These options may be changed or new options added as determined appropriate by the Company. A customer may select one of the following Toll and Casual Dialing Restriction options:

Option #1 1+ DDD
0-, 0+, 00-
01/011+DDD to numbers outside the
North American Numbering Plan
Directory Assistance (411, 1411, 555-1212,
1-555-1212, 1-NPA-555-1212)
101XXXX access to toll numbers
Toll Free Code numbers (1 + 800, 1 + 888, etc.)
N11, 500, 700, 900, 976 (Allows 1+710 and 911 calls)

Option #2 1+ DDD
0-, 0+, 00-
01/011+DDD to numbers outside the
North American Numbering Plan
Directory Assistance (411, 1411, 555-1212,
1-555-1212, 1-NPA-555-1212)
101XXXX access to toll numbers
N11, 500, 700, 900, 976 (Allows toll free, 1+710 and 911 calls)

3. Rates

- a. Rates and charges are in addition to the established monthly and non-recurring charges applicable to services or equipment associated with Toll and Casual Dialing Restriction Service.

	Monthly Rate		Installation Charge
	<u>Residence</u>	<u>Business</u>	
Option #1	\$4.00	\$4.00	(1)
Option #2	\$4.00	\$4.00	(1)

(1) Service connection charges where applicable.

16 2009

Comm. Dept

UNITED TELEPHONE COMPANY OF THE WEST d/b/a CENTURYLINK
NEBRASKA
GENERAL EXCHANGE PRICE LIST

SECTION 11

PAGE: 8

RELEASE: 4

ISSUED: May 20, 2021

EFFECTIVE: June 1, 2021

SUPPLEMENTAL SERVICES

H. DIRECT INWARD DIALING SERVICE (DID)

DID subscribers may need to purchase additional features or services to comply with the dispatchable location provisions of RAY BAUM's Act, as described in the Multi-Line Telephone Systems section under General Rules and Regulations Applying to Telephone Service.

(N)

(N)

1. Regulations

- a. Direct Inward Dialing is available only in those central offices that are equipped for such service and is furnished only for use with P.A.B.X. systems equipped for D.I.D. provided by the Telephone Company or compatible customer-owned P.A.B.X. systems.
- b. Construction charges may apply where equipment or facilities required to provide a requested service are not available.
- c. The charges applicable to direct inward dialing service contemplate the use of standard Telephone Company equipment service and arrangements. When special equipment or services are required, additional rates based upon the additional costs incurred to provide the service will apply.
- d. One primary directory listing will be provided with each account subscribing to D.I.D.
- e. The rates specified in this section are in addition to rates for other services with which this is associated.
- f. Station numbers for direct inward dialing will be assigned in blocks of 100 ⁽¹⁾ by the telephone company. Numbers assigned shall not exceed 99 vacant numbers. As additional station numbers are required, they will be made available as soon as the Telephone Company has equipment available for this purpose. No guarantee is made that station numbers will be available in all cases.
- g. The customer shall be responsible for the interception of calls placed to non-working station number.
- h. The initial service period for Direct Inward Dialing shall begin on the date service is installed and shall continue for a period of three years in the same central office.
- i. Requests for DID Service in non-digital exchanges will be considered on an individual basis.

⁽¹⁾ Station numbers for direct inward dialing furnished from central offices equipped with digital switching equipment may be assigned blocks of 10 numbers.

UNITED TELEPHONE COMPANY OF THE WEST - NEBRASKA
GENERAL EXCHANGE
PRICE LIST

SECTION 11
PAGE: 9
RELEASE: 3
EFFECTIVE: June 26, 2009

ISSUED: June 16, 2009

SUPPLEMENTAL SERVICES

H. DIRECT INWARD DIALING SERVICE (DID) (Cont'd) (T)
(D)
(M)
(M)

2. Rates

a. The rates listed below are applicable to D.I.D. Service.

	<u>Installation Charge</u>	<u>Monthly Rate</u>	
1) Central Office Common - Equipment for up to 16 DID Trunks in Digital Central Offices FCETCEQ DIG	(1)	\$ 68.00	(T) (T)
2) DID Trunk Circuit Plate, each, for Digital Central Offices FCETDTE DIG RMEMMCC	(1)	\$ 4.60	(T)
3) Direct Inward Dialing Numbers per 100, FCETCCD	(1)	\$160.00	(T)
4) Direct Inward Dialing Numbers in increments of 10, per 10 DID numbers, FCETCCD TEN (Digital offices only)	(1)	\$ 17.00	(T)
5) Interconnecting DID Access Trunk, (TSRALC B) (TSRTL C) (QEBB)	(1)	\$ 25.00	(T)
6) Direct Inward Dialing Numbers in increments of 10, per 10 DID numbers for mobile telephone number group (RMEMNUM TCY) (Digital offices only)	(1)	\$ 6.65	(T)
7) Direct Inward Dialing Numbers in increments of 10, per 10 DID numbers for Mobile Paging telephone number group (RPMNUM TCY) (Digital offices only)	(1)	\$ 2.55	(T)

(M) Material previously appearing on this page now appears on Page 8, Release 3.

16 2009

(1) **Service connection charges where applicable.** (T)

UNITED TELEPHONE COMPANY OF THE WEST - NEBRASKA
GENERAL EXCHANGE
PRICE LIST

SECTION 11
PAGE: 9.1
RELEASE: 3

ISSUED: June 16, 2009

EFFECTIVE: June 26, 2009

SUPPLEMENTAL SERVICES

- H. DIRECT INWARD DIALING SERVICE (DID) (Cont'd) (T)
3. Direct Inward Dialing Functionality
- a. Direct Inward Dialing Functionality is an optional service for Commercial Mobile Radio Service (CMRS) providers that provides DID service for Land to Mobile traffic being transported over a DID trunk facility.
- b. There are no charges applicable for the performance by the Telephone Company of DID Functionality for analog mobile facilities or DSO facilities: (T)

16 2009

Comm

UNITED TELEPHONE COMPANY OF THE WEST - NEBRASKA
GENERAL EXCHANGE
PRICE LIST

SECTION 11

PAGE: 10

RELEASE: 6

ISSUED: June 16, 2009

EFFECTIVE: June 26, 2009

SUPPLEMENTAL SERVICES

I. BILLED NUMBER SCREENING

(T)

1. General

Billed Number Screening provides customers with the capability of restricting collect and/or third number billing to their telephone number. Callers attempting to place a billed to third number or collect call to a BNS equipped line will be advised by the operator that such billing is unauthorized. The customer's telephone number will be included in a data base made available to companies that provide validation services. Inclusion in the data base indicates incoming collect and third number billed calls will not be allowed for billing to the customer's line.

BNS is limited to calls handled by Local Exchange Companies or Interexchange Carriers that access the validation data base and cannot guarantee operator screening of incoming collect, international collect and third number billed calls to their subscribers. Charges for any such calls will be the responsibility of the customer.

2. Rates and Charges

Billed Number Screening Per telephone number screened	S&E Code	Monthly Rate		Installation Charge
		<u>Residence</u>	<u>Business</u>	
Per Line	AAABNSG	\$3.50	\$ 3.50	(1)

(1) Addition or deletion of this service will incur a Record Order charge.

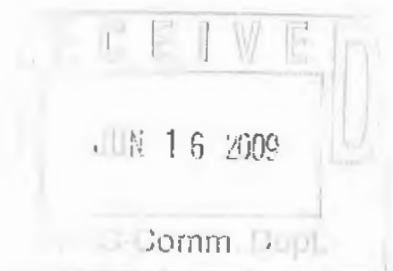

UNITED TELEPHONE COMPANY OF THE WEST - NEBRASKA
GENERAL EXCHANGE
PRICE LIST

SECTION 11
PAGE: 11
RELEASE: 2

ISSUED: June 16, 2009

EFFECTIVE: June 26, 2009

SUPPLEMENTAL SERVICES

J. SPECIAL MONTHLY BILLING

1. General

When a subscriber requests that a special toll calling card be rendered in order to facilitate their monthly bookkeeping, the following rate will apply.

2. Rates

<u>S&E Code</u>	<u>Monthly Rate</u>
ASBSTCC	\$1.05

(T)

(T)

(T)

(T)

(T)

JUN 16 2009

UNITED TELEPHONE COMPANY OF THE WEST - NEBRASKA
GENERAL EXCHANGE
PRICE LIST

SECTION 11
PAGE: 12
RELEASE: 1

ISSUED: August 20, 2004

EFFECTIVE: September 1, 2004

SUPPLEMENTAL SERVICES

K. Call Line Identifier

1. General

- a. Call Line Identifier is used to attempt to trace and identify, at the request of a subscriber, the source or origin of obscene, harassing, and/or other nuisance type of telephone calls. Call Line Identifier service is intended for situations where subscribers require extended trace for a specified length of time on a per line basis. The Call Trace feature, as specified in Section 12 of this price list, differs from Call Line Identifier service in that Call Trace is activated on a per call basis.

2. Regulations

- a. Subscribers initiate requests for Call Line Identifier service by contacting the Annoyance Call Center.
- b. Requests for Call Line Identifier service will be evaluated by the Annoyance Call Center. The Company will trace calls when requested based upon the availability of line identification equipment.
- c. Call Line Identifier service will apply per line upon request at the rates and for the time periods specified in Section 11.K.3. following.
- d. The Company does not guarantee successful call trace results when line identification equipment is placed. When call trace results are successful, the identity of the offending line subscriber will only be furnished to the appropriate law enforcement agency, pursuant to signed Disclosure Authorization by the offended subscriber.
- e. In the event a customer requested call trace is unsuccessful, the customer will be given the option of changing the telephone number at no charge.
- f. The Company will not be liable for any damages or injuries of whatever kind to property or to any individuals, which may, in any manner, result from the provision of this service, or from any mistakes, interruptions, delays, or errors by the Company in connection with Call Line Identifier service which were not caused by the Company's failure to maintain proper standards of maintenance and operation or by the Company's failure to exercise reasonable supervision (i.e., willful neglect).

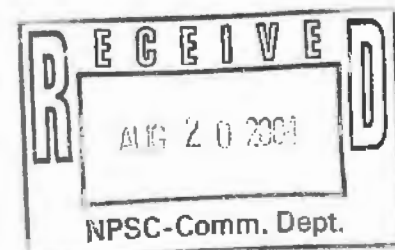

UNITED TELEPHONE COMPANY OF THE WEST - NEBRASKA
GENERAL EXCHANGE
PRICE LIST

SECTION 11
PAGE: 13
RELEASE: 2
EFFECTIVE: May 1, 2015

ISSUED: April 21, 2015

SUPPLEMENTAL SERVICES

K. Call Line Identifier (Cont'd)

2. Regulations (Cont'd)

- g. This price list does not apply to trap and trace ordered by the state or federal courts, or to emergency situations, such as kidnapping, threatening of jurors, witnesses, or judicial officers, or similar emergencies, declared by law enforcement agency within its legal powers.
- h. Any Call Line Identifier conducted under this price list shall be at the discretion of the Company and is subject to the availability of facilities.
- i. **Call Line Identifier will be provided without charge for up to three administrative lines associated with law enforcement and public safety organizations.** (N)
(N)

3. Rates and Charges

Nonrecurring Charge, Per Line	30-Day Period	12-Month Period
Initial	\$ 46.00 (R)	\$ 108.00 (I)
Renewal, Each	20.00	41.00 (I)

(T)
|
(T)

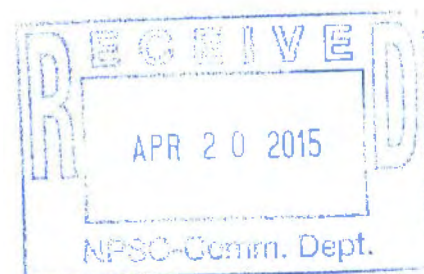

UNITED TELEPHONE COMPANY OF THE WEST - NEBRASKA
GENERAL EXCHANGE
PRICE LIST

SECTION 12

PAGE: 1

RELEASE: 9

ISSUED: July 22, 2008

EFFECTIVE: August 1, 2008

NETWORK SERVICES

I. GENERAL

Custom Calling Features

Custom Calling Features are optional telephone service arrangements which provide one or more of the following features:

A. Enhanced Call Waiting

Alerts a customer who is using his telephone, by means of an audible tone, that another call is trying to reach him. Call Waiting Control is included, which allows customers to turn off the call waiting tone before or during a call (but before the call waiting tone has been heard), so that the call will not be interrupted by the call waiting tone. The call waiting tone capability will automatically be restored when the call is terminated. Call Waiting Control will be provided in those exchanges where facilities permit.

B. Call Forward Features

Call Forward Features permit the forwarding of incoming calls under a variety of conditions to another telephone number either by dialing an activation code or via pre-programming by the Company. Calls may be forwarded to any number subject to the availability of the necessary facilities in the central office from which the calls are to be transferred. The customer subscribing to this service is responsible for applicable usage charges. Only one call forwarding arrangement, consisting of a single calling path, will be provided per exchange service line for which the customer subscribes to this feature, unless the customer is also subscribed to the Call Forward Additional Paths feature, in which instance one call path per Call Forward Additional Path feature subscribed to will be provided. **When the Customer's designated forward-to number is not in the Customer's local or expanded local calling area, the use of multiple paths for the completion of simultaneous toll calls may be subject to restrictions or prohibitions imposed by the Customer's Presubscribed Interexchange Carrier.**

(N)
|
(N)

Call Forward Features shall not be used to extend calls on a planned and continuing basis to intentionally avoid the payment in whole or in part, of usage charges that would regularly be applicable between the station originating the call and the station to which the call is ultimately transferred. If the Company determines that Call Forward Features are being used in manner not consistent with the intent of the service or in any other way violates the restrictions of the service, the Subscriber will be determined ineligible for the service and the service will be removed from the Customer's account.

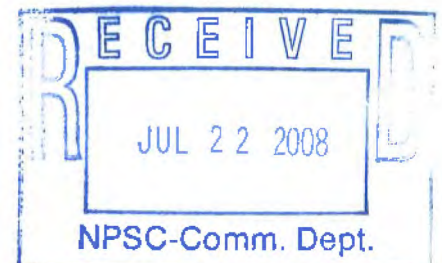

UNITED TELEPHONE COMPANY OF THE WEST - NEBRASKA
GENERAL EXCHANGE
PRICE LIST

SECTION 12

PAGE: 1.01

RELEASE: 3

ISSUED: June 10, 2008

EFFECTIVE: June 20, 2008

NETWORK SERVICES

I. GENERAL (Cont'd)

Custom Calling Features (Cont'd)

B. Call Forward Features (Cont'd)

1. Call Forwarding

This feature permits the manual forwarding of incoming calls to another telephone number. When activated, all calls will forward; calls cannot be answered from a line with Call Forwarding activated. Call Forwarding overrides Call Forward No Answer and Call Forward Busy, but those features resume functionality when Call Forwarding is deactivated.

a. Call Forwarding (FCF1FLC) – Provides a customer the capability to control activation/deactivation and the forward-to number of the service by using dialing tones.

2. Call Forward No Answer

This feature permits the automatic forwarding of an incoming call to another telephone number when the called telephone remains unanswered for a predetermined number of rings, usually four or five.

Where facilities are available, this feature also includes Call Forwarding of Call Waiting when the customer is also subscribed to **Enhanced** Call Waiting. Call Forwarding of Call Waiting forwards unanswered waiting calls to a customer-designated telephone number using **Enhanced** Call Waiting and Call Forward No Answer. An incoming call to a busy line first receives a call waiting tone. If the call is not answered within a set period of time, the incoming call is forwarded to a customer-designated telephone number.

(T)

(T)

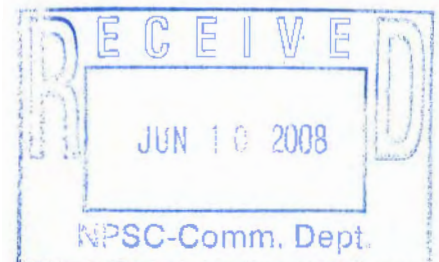

UNITED TELEPHONE COMPANY OF THE WEST - NEBRASKA
GENERAL EXCHANGE
PRICE LIST

SECTION 12
PAGE: 1.1
RELEASE: 4

ISSUED: May 26, 2009

EFFECTIVE: June 5, 2009

NETWORK SERVICES

I. GENERAL (Cont'd)

Custom Calling Features (Cont'd)

B. Call Forward Features (Cont'd)

2. Call Forward No Answer (Cont'd)

- a. Call Forward No Answer-Fixed (FCD1FLC) – This feature is activated and the customer selected forward-to number is preprogrammed by the Company at the time service is established and can only be changed via service order.
- b. Call Forward No Answer-Customer Programmable (FCD1FLC PRG) – Provides a customer the capability to control activation/deactivation and the forward-to number of the service by using dialing tones.

3. Call Forward Busy

This feature permits the automatic forwarding of an incoming call to another telephone number when the called telephone is already in use. Call Forward Busy shall not be used **by business customers** to extend calls on a planned and continuing basis to intentionally avoid the payment of **Rotary Hunt Service**. **Residence customers may utilize Call Forward Busy in lieu of Rotary Hunt Service for up to five lines at the same or different residential locations.**

- a. Call Forward Busy-Fixed (FCB1FLC) – This feature is activated and the customer selected forward-to number is preprogrammed by the Company at the time service is established and can only be changed via service order.
- b. Call Forward Busy-Customer Programmable (FCB1FLC PRG) – Provides a customer the capability to control activation/deactivation and the forward-to number of the service by using dialing tones.

(C)
|
(C)

MAY 26

UNITED TELEPHONE COMPANY OF THE WEST - NEBRASKA
GENERAL EXCHANGE
PRICE LIST

SECTION 12
PAGE: 1.2
RELEASE: 2

ISSUED: October 29, 2007

EFFECTIVE: November 8, 2007

NETWORK SERVICES

I. GENERAL (Cont'd)

Custom Calling Features (Cont'd)

B. Call Forward Features (Cont'd)

4. Call Forward Additional Paths (FCF1FLC PTH)

Business customers who subscribe to Call Forward No Answer-**Fixed** or Call Forward Busy-**Fixed** may also subscribe to the Call Forward Additional Paths feature. This feature is not available with Call Forward Features that allow customers to remotely change the forward-to telephone number. Call Forward Additional Paths allows a business Call Forwarding subscriber the ability to specify the number of simultaneous calls that will be forwarded to the forward-to telephone number. Regulations for Call Forward features are also applicable for each Call Forward Additional Path.

(D)
(D)

- a) The forward-to telephone number must be a domestic telephone number.
- b) The Call Forward Additional Paths customer must subscribe to sufficient paths to adequately handle incoming calls without impairing any service offered by the Company.
- c) The number of paths may not exceed the terminating capability of the forward-to telephone number. In no case, shall the number of additional paths exceed 99.
- d) Customers with a single (non-rotary) exchange line/trunk or a rotary (hunting) arrangement of 10 or less lines/trunks may purchase up to 10 additional paths.
- e) For customers with a rotary hunting arrangement of more than 10 lines/trunks, the number of additional paths cannot exceed the number of lines/trunks in the forwarding arrangement.
- f) The applicable Service Connection Charges will be charged when the number of paths is changed or when the forward-to telephone number is changed.

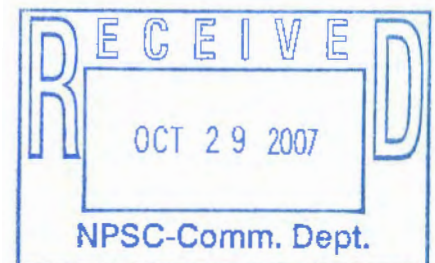

UNITED TELEPHONE COMPANY OF THE WEST - NEBRASKA
GENERAL EXCHANGE
PRICE LIST

SECTION 12

PAGE: 1.3

RELEASE: 2

ISSUED: June 10, 2008

EFFECTIVE: June 20, 2008

NETWORK SERVICES

I. GENERAL (Cont'd)

Custom Calling Features (Cont'd)

C. Three-Way Calling

Enables a customer to add a third party to an existing call without operator assistance, thereby establishing three-way conversation. The transmission quality of the call may vary depending on the distance and routing necessary; therefore, transmission may not meet normal standards. This feature is available for a flat monthly rate or on a usage sensitive basis. To use the service on a usage sensitive basis, the customer must press an activation code *71, (1171 for rotary phones), prior to dialing the second party's number. The customer will incur an activation charge for each completed call.

D. Speed Dial 8

Speed Dial 30 ⁽¹⁾

(T)

(T) (C)

Enables a customer to place calls to other telephone numbers by dialing a one- or two-digit code rather than the complete telephone number. The 8-code capacity and/or the 30-code capacity may be provided on the same line.

E. Directory Number Transfer ⁽¹⁾

(C)

Permits a customer to transfer all incoming calls to a fixed single telephone number within the exchange or on the Long Distance Telecommunications Network where facilities permit.

⁽¹⁾ Effective June 20, 2008, this service will no longer be available for new installations.

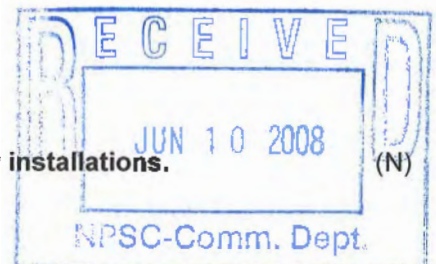

UNITED TELEPHONE COMPANY OF THE WEST - NEBRASKA
GENERAL EXCHANGE
PRICE LIST

SECTION 12

PAGE: 2

RELEASE: 8

ISSUED: November 1, 2021

EFFECTIVE: November 11, 2021

NETWORK SERVICES

I. GENERAL (Cont'd)

Custom Calling Features (Cont'd)

F. Hot Line/Warm Line ⁽¹⁾

Automatically routes the customer's telephone to a predetermined trunk or telephone number when the handset is removed. The Hot Line is switched immediately and the Warm Line is switched after a brief timing period and prior to dialing.

G. Intercom ⁽¹⁾

Allows customers with an individual residence or business line to use their line to provide an intercom system between their telephones. This is accomplished by the customer dialing his own number, receiving a recording and hanging up. All telephones at that number will then ring and when one of the other telephones goes off-hook, the ringing will stop and the initiator of the call can go off-hook and engage in conversation.

H. SignalRing (a.k.a. Custom Ring)

(T)

Provides for a second directory number to be added to an existing telephone line. The second number will have a distinctive coded ring. If the customer elects to list the second line in the directory, charges as specified in the Directory Listings Section will apply.

I. Remote Call Forward (FCF1MLC)

Remote Call Forward (RCF) allows all calls dialed to a telephone number equipped for RCF Service to be automatically forwarded to another dialable telephone number. This service enables a customer to list a local directory number that is forwarded to a different city or exchange. The RCF customer is responsible for any applicable usage rates/charges between the RCF number and the terminating number.

⁽¹⁾ Effective June 20, 2008, this service will no longer be available for new installations.

UNITED TELEPHONE COMPANY OF THE WEST - NEBRASKA
GENERAL EXCHANGE
PRICE LIST

SECTION 12
PAGE: 2.1
RELEASE: 3

ISSUED: July 22, 2005

EFFECTIVE: August 1, 2005

NETWORK SERVICES

I. GENERAL (Cont'd)

Custom Calling Features (Cont'd)

J. Call Transfer (FTR1FAB)

1. **Call Transfer** - This feature allows a user to receive a call and transfer to a second destination while maintaining privacy from the first call, or to add on the previously held call for a three-way conference. Incoming calls may be transferred to another access arrangement on an inter- or intra-switch basis.

The subscriber can transfer the caller to the secondary destination in one of three ways:
 - a. **Blind Transfer**
By placing the original caller on hold, dialing the secondary destination, and upon hearing the ring, hang up, resulting in the original caller being connected to the secondary destination.
 - b. **Announced Transfer**
By placing the original caller on hold, dialing the secondary destination, and upon the party at the secondary destination answering the phone, the subscriber announces the transfer of the call (on hold at the time) and hangs up (on hook), resulting in the original caller being connected to the secondary destination.
 - c. **Three-Way Conferencing with Option to Transfer**
By placing the original caller on hold, dialing the secondary destination, and upon the party at the secondary destination answering the phone, taking the original caller off-hold; resulting in a three way connection. The subscriber can then hang up; resulting in the original caller continuing to be connected to the caller at the secondary destination.
2. The subscriber of Call Transfer can receive or originate the initial call. Call Transfer allows the subscriber to originate both legs of a three way connection and subsequently disconnect, enabling the other parties to remain connected.
3. Where the subscriber originates both legs of a three-way call, those legs will remain bridged together when the subscriber goes on hook when at least one of the legs is a call for which both the originating and terminating points are served by the same switch. Where the subscriber originates two inter-switch legs of a three-way call, both legs remain bridged when the subscriber goes on hook where the serving switch is not a 5ESS switch. For such calls in a 5ESS switch, both inter-switch legs are disconnected when the subscriber goes on hook.

(D)
—
(D)

(T)

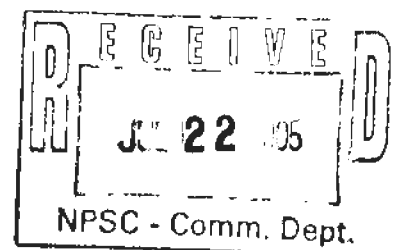

UNITED TELEPHONE COMPANY OF THE WEST - NEBRASKA
GENERAL EXCHANGE
PRICE LIST

SECTION 12
PAGE: 2.2
RELEASE: 5

ISSUED: December 22, 2017

EFFECTIVE: January 2, 2018

NETWORK SERVICES

I. GENERAL (Cont'd)

Custom Calling Features (Cont'd)

J. Call Transfer (FTR1FAB) (Cont'd)

4. Call Transfer shall not be used to extend calls on a planned and continuing basis to intentionally avoid the payment in whole or in part of message charges, toll or otherwise, that would regularly be applicable between the stations bridged together by the subscriber.
5. The Call Transfer subscriber is responsible for any applicable usage rates and charges between the Call Transfer subscriber's telephone number and the secondary designated number. The use of this feature by the subscriber to complete simultaneous outgoing calls may be subject to restrictions or prohibitions imposed by the Customer's Presubscribed Interexchange Carrier, if the calls are not in the Customer's local or expanded local calling area.
6. Where a subscriber has Call Transfer and Three-Way Calling, Call Transfer takes precedence and any three-way call initiated will be transferred in the event the subscriber disconnects from the three-way call. Usage and charges associated with and between the remaining parties, if applicable, will remain the responsibility of the subscriber who initiated the conference.

K. Outbound Call Block Feature ⁽¹⁾

1. This feature blocks all outbound dialing with the exception of abbreviated dialing for 911 (Emergency Reporting Services) and 711 (Service for Telecommunications Relay Services). In addition, all pay-per-use features are blocked.
2. All other Custom Calling Features and ExpressTouch features are prohibited with the use of this feature and lines equipped with this feature will not have a directory listing.
3. This feature is subject to the availability of facilities and is only available to residence individual line and business individual line customers.

⁽¹⁾ Effective January 2, 2018, Outbound Call Block Feature is grandfathered for residential customers. Availability to current residential customers is limited to lines in service at existing locations.

Received

DEC 22 2017

NPSC Comm. Dept.

(N)
|
(N)

UNITED TELEPHONE COMPANY OF THE WEST - NEBRASKA
GENERAL EXCHANGE
PRICE LIST

SECTION 12
PAGE: 3
RELEASE: 9

ISSUED: June 16, 2009

EFFECTIVE: June 26, 2009

NETWORK SERVICES

I. GENERAL (Cont'd)

ExpressTouch Features

ExpressTouch is the Company's registered service mark for a set of advanced call management features. These features are commonly known as Custom Local Area Signaling Services (CLASS).

A. Return Call

Return Call allows the customer to call the telephone number associated with their last incoming call whether or not the call was answered or the telephone number is known by the customer. To operate Return Call, enter activation code *69 (1169 on rotary phones). If the called line is available, the call is immediately completed. If the called line is not available, a queuing process, which may last up to thirty minutes, takes place. When both lines are available, the customer receives a distinctive ring that the network is ready to place the call. When the customer answers the telephone, the call is automatically placed.

Return Call is available on a flat monthly rate or on a usage sensitive basis. Under the usage sensitive option, whether the customer chooses to advance the call or abandon the call, the usage activation charge applies, unless the originating line information is not available. The provision of this service on a usage sensitive basis is subject to technical limitations and is provided where facilities are available.

Return Call cannot return a call to the telephone number of the last incoming call if the telephone number was originally blocked by the calling party.

B. Caller ID - Number Only ⁽¹⁾

Caller ID - Number Only allows the customer to view the telephone number of an incoming call before answering. During the time that the incoming call is placed, the calling number is forwarded from the central office to compatible customer provided auxiliary equipment. The calling telephone number is then delivered to the customer provided auxiliary equipment between the first and second ring.

The calling telephone number is not available from calls made from most cellular phones or units and certain interexchange carrier calls. The calling number is also not available when incoming calls have been handled by an operator or charged to credit cards. The number delivered for calls originated from a PBX will display the main PBX trunk number only. If the caller's number is not part of the ExpressTouch network or is blocked, the number will not be displayed.

(C)

⁽¹⁾ Effective June 20, 2008, this service will no longer be available for new installations.

UNITED TELEPHONE COMPANY OF THE WEST - NEBRASKA
GENERAL EXCHANGE
PRICE LIST

SECTION 12

PAGE: 4

RELEASE: 9

ISSUED: June 16, 2009

EFFECTIVE: June 26, 2009

NETWORK SERVICES

I. GENERAL (Cont'd)

ExpressTouch Features (Cont'd)

B. Caller ID - Number Only ⁽¹⁾ (Cont'd)

Caller ID - Number Only customers who do not wish to receive calls with blocked numbers can activate Anonymous Call Rejection by dialing *77 (1177 on rotary phones). While the feature is activated, incoming calls with blocked numbers are routed to an announcement in the central office. The code to deactivate this feature is *87 (1187 on rotary phones). Anonymous Call Rejection is automatically available, in the deactive state, to residence subscribers of Caller ID - Number Only and to business subscribers where technically feasible.

Subscription to Caller ID - Number Only on Centrex access lines is only available on the customer group level and not on a per line basis. Rates and charges, however, will apply on a per line basis.

C. Caller ID With Name

Caller ID With Name functions in the same manner as Caller ID - Number Only but also includes the delivery of a calling party's name. The name and number are displayed on compatible customer provided auxiliary equipment.

The name displayed shall be the name associated with the calling telephone number as shown on the Company's records. The Company, at its discretion, may abbreviate or limit that name for display purposes. The Company does not assure name accuracy, and it shall not be liable to any party for errors, omissions, or mistakes. The Company's sole and only obligation shall be to reasonably correct errors in names when notified in writing of such errors.

Caller ID With Name customers who do not wish to receive calls with blocked numbers can activate Anonymous Call Rejection by pressing *77 (1177 on rotary phones). The code to deactivate is *87 (1187 on rotary phones). While the feature is activated, incoming calls with blocked numbers are routed to an announcement in the central office. Anonymous Call Rejection is automatically available, in the deactive state, to residence subscribers of Caller ID With Name and to business subscribers where technically feasible.

The calling telephone name and number is not available from calls made from most cellular phones or units and currently from some interexchange carriers and other local exchange carrier calls. The calling name and number are also not available when incoming calls have been handled by an operator or charged to credit cards. Name and number delivery for calls originated from a PBX will display the main PBX name and number only. If the caller's name and number are not part of the ExpressTouch network or is blocked, the name and number will not be displayed. (C)

⁽¹⁾ Effective June 20, 2008, this service will no longer be available for new installations. JUN 16 2009

UNITED TELEPHONE COMPANY OF THE WEST - NEBRASKA
GENERAL EXCHANGE
PRICE LIST

SECTION 12

PAGE: 5

RELEASE: 3

ISSUED: September 28, 2004

EFFECTIVE: October 11, 2004

NETWORK SERVICES

I. GENERAL (Cont'd)

ExpressTouch Features (Cont'd)

(T)

C. Caller ID With Name (Cont'd)

Subscription to Caller ID With Name on Centrex access lines is only available on the customer group level and not on a per line basis. Rates and charges, however, will apply on a per line basis.

D. Caller ID Blocking

Caller ID blocking allows the subscriber to prevent the delivery of the subscriber's directory name and/or number on a per call basis (per call block) or per line basis (per line block).

Per call blocking will block the delivery of the subscriber's name and/or number for one call only and may be activated by dialing an activation code (*67 from a Touch-Tone telephone or 1167 from a rotary telephone) immediately prior to placing a call. The activation code will initiate per call blocking, which is available at no charge.

If the calling party activates blocking, the directory name and/or number will not be transmitted across the line. Instead, Caller ID customers will receive an anonymous indicator. This anonymous indicator notifies the Caller ID customer that the calling party has elected to block the delivery of the telephone name and/or number.

Per line blocking will automatically block delivery of the subscriber's telephone name and/or number on all calls. Line blocking for the delivery of the calling name and/or number is available upon request, at no charge, to the following entities and their employees/volunteers, for lines over which the official business of the agency is conducted including those at the residences of employees/volunteers, where an executive officer of the agency registers with the Company a need for blocking: (a) private, nonprofit, tax-exempt, domestic violence intervention agencies and (b) federal, state and local law enforcement agencies. The calling name and/or number will not be transmitted from a line equipped with this capability.

Wherever per-line blocking is provided, per call unblocking is available at no charge to enable delivery of the calling party name and/or number. By dialing the activation code, *82 or 1182 from a rotary phone, the next attempted call will deliver the calling party name and/or number.



UNITED TELEPHONE COMPANY OF THE WEST - NEBRASKA
GENERAL EXCHANGE
PRICE LIST

SECTION 12

PAGE: 6

RELEASE: 5

ISSUED: June 10, 2008

EFFECTIVE: June 20, 2008

NETWORK SERVICES

I. GENERAL (Cont'd)

ExpressTouch Features (Cont'd)

E. Call Trace

Call Trace enables the customer to initiate an automatic trace of the last incoming call received, regardless of the time lapse since that call, providing there have been no intervening outgoing calls. To initiate the trace, the customer must dial an activation code, then dial a "1". Upon activation by the customer, the network automatically sends a message to the Telephone Company indicating the calling number, the time the call was received, and the time the trace was activated. The customer using this feature would be required to contact the local telephone company business office for further action. The customer is not provided the traced number.

If the customer makes or receives another call before activating the trace, or if a call waiting feature (described in other sections of this tariff) is activated prior to activating the trace, Call Trace feature will not record the correct number. (T)

Call Trace will trace only those calls which are originated from a location served by the ExpressTouch network. A separate charge applies to each successful activation of this feature.

In situations where the Call Trace functionality is activated by a subscriber, information pertaining to non-published numbers will be provided to the authorized law enforcement agency upon request of the agency.

F. Repeat Dial (T)

Repeat Dial allows the customer to automatically redial the last number dialed from the customer's telephone regardless of whether the last number dialed was answered. To operate the **Repeat Dial** function, enter activation code *66 (1166 on rotary phones). If the called line is available, the call will be placed immediately. Where technically feasible, when a caller receives a busy condition, the service will automatically play an announcement offering the caller the option of having the service complete the call when the called line becomes available by entering the activation code "7". If the redialed line is busy, the network will queue the request for thirty minutes and process the call when both the called and calling party lines are idle. When the call can be completed, a distinctive ring will be provided to the caller's line to alert the customer that the requested callback is ready. When the customer answers the telephone, the call is automatically placed. (T)

This feature cannot be activated for calls originating from a line that is forwarded. (T)

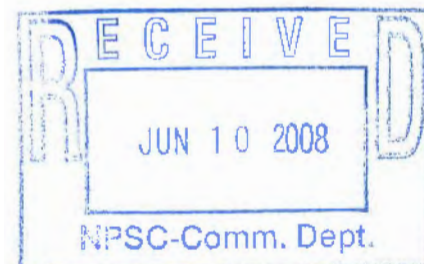

UNITED TELEPHONE COMPANY OF THE WEST - NEBRASKA
GENERAL EXCHANGE
PRICE LIST

SECTION 12
PAGE: 6.2
RELEASE: 2

ISSUED: February 6, 2006

EFFECTIVE: February 16, 2006

SPECIAL PROMOTIONS

- I. Network Services Promotion (Continued)
- Z. During the period January 27, 2006 through April 24, 2006, business customers who contact the Company to request that the telephone number associated with one of the following services be ported to another service provider, will receive a \$5.50 credit per B1 line up to four lines per month for 3 months when customers agree to retain their access line service:
- 1) Individual access line service (B1) with or without Rotary Hunt Service;
 - 2) Any Sprint Solutions Package

The credit will be applied on the customer's next three invoices.

- AA. During the period January 27, 2006 through April 24, 2006, when a business customer establishes a new account and subscribes to Business Local Service (B1) and also subscribes to one of the following services, the Company will waive all nonrecurring installation and/or service charges that are otherwise applicable with the B1 service:
- 1) Economy Bundle II A package;
 - 2) Sure Solution II package;
 - 3) Sprint Priority Solution package;
 - 4) Rotary Classics Solution package

This offer cannot be combined with any other promotional offer.

- AB During the period February 16, 2006 through May 31, 2006, residence customers who subscribe to Sprint Home II Solution bundle plus Sprint Communications Company L.P. or Sprint Long Distance, Inc. Sprint Solutions Unlimited Market Test – Option 2 or Sprint High Speed Internet, will receive a \$10.00 discount on the Home II Solution bundle for 12 months. Customers must be contacted by the Company or must contact the Company and request this promotion.

(N)
|
(N)

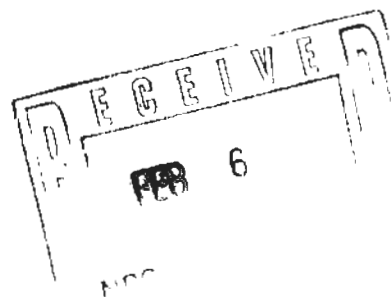

UNITED TELEPHONE COMPANY OF THE WEST - NEBRASKA
GENERAL EXCHANGE
PRICE LIST

SECTION 12

PAGE: 7

RELEASE: 5

ISSUED: November 1, 2021

EFFECTIVE: November 11, 2021

NETWORK SERVICES

I. GENERAL (Cont'd)

ExpressTouch Features (Cont'd)

G. Selective Call Forward

Selective Call Forward allows the customer to transfer selected calls to another telephone number. A screening list of numbers is created by the customer and placed in the network memory via an interactive dialing sequence. This list can only be created from ExpressTouch Service serving area telephone numbers. Only calls from those telephone numbers in the screening list may be forwarded to the designated telephone number.

For calls from a line within multi-line hunting the call is selectively forwarded only when the main telephone has been entered in the screening list.

Calls may be forwarded to a number within the subscriber's home exchange, EAS exchanges, or to a long distance message telecommunications point subject to the availability of the necessary facilities in the central office from which the calls are to be transferred. The customer subscribing to this service is responsible for applicable usage charges or toll charges.

H. Selective Call Rejection

Selective Call Rejection provides the customer the ability to prevent incoming calls from certain telephone numbers. Through an interactive dialing sequence, the customer creates a screening list of telephone numbers in the ExpressTouch network. When a call is placed to the customer's number from a number on the screening list, the calling party receives an announcement indicating that the call cannot be completed to the called party at this time.

For calls from a line within multi-line hunting the call is blocked only when the main telephone number has been entered in the screening list.

I. Selective Call Ring (**a.k.a. Priority Call**)

(T)

Selective Call Ring (**a.k.a. Priority Call**) provides a distinctive ringing pattern to the subscribing customer for specific telephone numbers. The customer creates a screening list of telephone numbers through an interactive dialing sequence. When a call is received from one of the predetermined telephone numbers, the customer is alerted with a distinctive ringing pattern. Calls from telephone numbers not included on the screening list will produce a normal ring.

(T)

If the called customer subscribes to Enhanced Call Waiting and the call arrives while the line is busy, the call waiting tone has the same distinctive patterns. For calls from a dial tone line with multi-line hunting, the distinctive signal is only produced when the main telephone number has been entered in the screening list.

UNITED TELEPHONE COMPANY OF THE WEST - NEBRASKA
GENERAL EXCHANGE
PRICE LIST

SECTION 12

PAGE: 7.1

RELEASE: 4

ISSUED: November 1, 2021

EFFECTIVE: November 11, 2021

NETWORK SERVICES

I. GENERAL (Cont'd)

ExpressTouch Features (Cont'd)

J. Selective Call Acceptance – **GRANDFATHERED** (C)

Effective November 11, 2021, Selective Call Acceptance is grandfathered. Availability to current customers is limited to lines in service at existing locations. (N)
(N)

Selective Call Acceptance **is** an arrangement that allows a subscriber to selectively accept only calls arriving from a list of up to 12 previously identified directory numbers. (T)

A call will only be accepted when it is received from a telephone number that matches one of up to 12 numbers on the Selective Call Acceptance list. Calls from telephone numbers that do not match one of the 12 numbers on the Selective Call Acceptance list will be routed to an announcement stating that the called party does not wish to receive the call. If the incoming call is from a telephone number in a multi-line hunt group, this feature will not work unless the number is the main telephone number in the group, or each terminal has a unique telephone number associated with it within the group.

The Selective Call Acceptance list is created by the Selective Call Acceptance subscriber, through an interactive dialing sequence, and can be altered at the subscriber's discretion.

This feature can be activated or deactivated at the subscriber's discretion.

K. Call Waiting ID

Allows the subscriber, with the use of a compatible customer provided display phone or adjunct display device, to view the directory number, and the name associated with that number, of an incoming call while engaged in another call. The subscriber receives a tone signal to indicate that another call is waiting to be completed to the subscriber's number. This feature is available only in certain Network Services Packages with other features required to enable it to work correctly.

UNITED TELEPHONE COMPANY OF THE WEST - NEBRASKA
GENERAL EXCHANGE
PRICE LIST

SECTION 12
PAGE: 8
RELEASE: 4

ISSUED: June 16, 2009

EFFECTIVE: June 26, 2009

NETWORK SERVICES

II. REGULATIONS

- A. Custom Calling Features with the exception of Intercom⁽¹⁾ will be provided in connection with individual and multi-line residence and business lines. Intercom will only be offered on individual lines. Trunk lines will be provided with custom calling features where technologically feasible. The restriction of custom calling features to trunk customers may be inherent due to equipment **limitations**. Pay Telephone, ISDN-BRI, ISDN-PRI, and RCF telephone services are excluded. (C)
- B. Other facilities, miscellaneous and supplemental equipment requested by customers and not detrimental to this service or other services of the Telephone Company will be furnished in accordance with regulations and at the rates specified in the applicable sections of this Price List.
- C. Network Services are available in equipped central offices.
- D. Usage Sensitive features are automatically available on the customer's line. Customers may request removal of these features at no charge.

16

⁽¹⁾ Effective June 20, 2008, this service will no longer be available for new installations.

UNITED TELEPHONE COMPANY OF THE WEST - NEBRASKA
GENERAL EXCHANGE
PRICE LIST

SECTION 12

PAGE: 9

RELEASE: 4

ISSUED: June 16, 2009

EFFECTIVE: June 26, 2009

NETWORK SERVICES

II. REGULATIONS (Cont'd)

- E. ExpressTouch features will only be offered on **individual line** service and will not be activated on **ISDN-BRI**, ISDN-PRI, and certain FX lines. Certain ExpressTouch features may be offered in conjunction with Key and PBX trunks, Centrex services, and Pay Telephone Services. (T)
(C)
- F. ExpressTouch features can be provided on a stand alone basis or may be enhanced by use with Custom Calling Features as described herein.
- G. ExpressTouch features are provided from specially equipped Company Central Offices and enable customers to access various features by dialing a specific code on either a rotary-dial or Touch-Tone calling basis.
- H. The customer of record will be responsible for payment of all the charges associated with ExpressTouch as described in Section IV.C. following. For each feature ordered on a per line basis, the customer of record will be charged the applicable monthly subscription rate for each line. For each usage sensitive feature used, the customer of record will only be charged the applicable per activation rate.
- I. ExpressTouch features are available to customers who have rotary or Touch-Tone service for calls within the ExpressTouch Calling Service area. Customers with rotary service can access ExpressTouch features by dialing 11 instead of *.
- J. An ExpressTouch customer may employ available ExpressTouch features only under either of the following:
- When both ExpressTouch customer and the other party involved in the call are served from the same central office, even if the other party does not subscribe to an ExpressTouch feature; or
 - When both the ExpressTouch customer and the other party involved in the call are served from different central offices which are linked by facilities that can handle the delivery of the calling name and/or number, even if the other party does not subscribe to ExpressTouch.

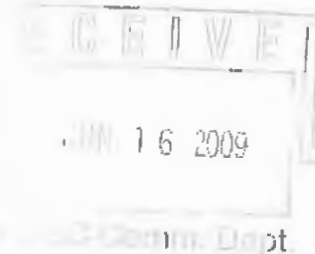

UNITED TELEPHONE COMPANY OF THE WEST - NEBRASKA
GENERAL EXCHANGE
PRICE LIST

SECTION 12
PAGE: 10
RELEASE: 3

ISSUED: February 17, 2022

EFFECTIVE: March 1, 2022

NETWORK SERVICES

II. REGULATIONS (Cont'd)

- K. ExpressTouch features will only be offered in exchanges which meet the necessary technical specifications. In addition, the Company reserves the right to offer ExpressTouch only where technologically feasible.
- L. Telephone numbers transmitted via Caller ID With Name and/or Number may not be sold or given to another party without the caller's consent. Caller ID With Name and/or Number information may only be used for: a) routing or completion of calls, b) billing of calls, c) account management purposes, d) services directly related to the call or transaction, e) verification of calling party identity. Caller ID With Name and/or Number customers failing to comply with any of these conditions may be subject to termination of these services.
- M. The calling party and customer relieves the Company against any and all claims for damages caused or claimed to have been caused, directly or indirectly, by the transmission to a Caller ID With Name and/or Number customer of a telephone number which the calling party has requested to be omitted from the telephone directory or has requested not to be disclosed to any person.
- N. Calls that reach a recording activated by Selective Call Rejection or Anonymous Call Rejection will be treated as calls that are not answered.
- O. Call Trace will be billed the activation charge shown in the IV. E. following only when the attempt to trace and record the calling telephone number is successful. The results of a successful trace will only be provided to legal authorities with proper authorization. The Telephone Company will not be liable for damages if, for any reason, an attempt is not successful.
- P. **As of March 1, 2022, changes, additions, or transfer of service will not be permitted on accounts associated with a grandfathered bundle or package or other grandfathered feature or service. This change does not impact services or features currently provided on grandfathered accounts. A grandfathered service is one that is no longer sold, and availability is limited to lines currently in service at existing locations. Changes, additions, or transfer of service will be allowed when customers migrate from a grandfathered service to a currently available service. Customers may remove any service or feature from their accounts at any time; however, grandfathered services removed may not be subsequently reinstated.**

UNITED TELEPHONE COMPANY OF THE WEST - NEBRASKA
GENERAL EXCHANGE
PRICE LIST

SECTION 12
PAGE: 11
RELEASE: 1

ISSUED: July 11, 1997

EFFECTIVE: July 23, 1997

NETWORK SERVICES

(N)

III. SERVICE GUARANTEE

(M)

If the customer notifies the Telephone Company that he/she is not satisfied with a Network Service(s), the customer is entitled to a full refund of one (1) month's recurring rate, or portion thereof, if subscription is less than 30 days. The service(s) for which the credit is being issued will be discontinued from the customer's line. This refund will be applied as a credit on the customer's bill. Each customer will be entitled to the credit one time per service. Customers who initially request a Network Service as listed in IV. following, will have 45 days from initiation of service to notify the Telephone Company of their intent to cancel the service(s) and receive a refund. Any customer that has had a Network Service more than 45 days will not be eligible for the refund on that service.

(T)

(T)

(T)

(M)

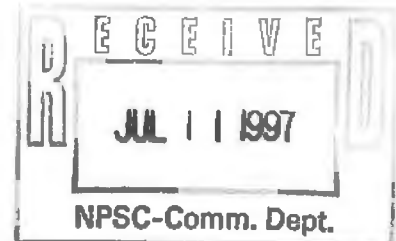

UNITED TELEPHONE COMPANY OF THE WEST - NEBRASKA
GENERAL EXCHANGE
PRICE LIST

SECTION 12

PAGE: 12

RELEASE: 15

ISSUED: November 1, 2021

EFFECTIVE: November 11, 2021

NETWORK SERVICES

IV. RATES

- A. The following rates and charges apply in addition to the established rates charged for the services with which these features are associated.
- B. There are no separate installation charges for the connection of these Custom Calling Features. Service Connection Charges do not apply when Customer Calling Features are installed.

Service Description	Monthly Rate	Installation Charge
Enhanced Call Waiting	\$6.00	N/A
Call Forwarding	5.00	N/A
Three-Way Calling	5.00	N/A
Speed Dial 8	5.00	N/A
Speed Dial 30 ⁽²⁾	6.00	N/A
Directory Number Transfer ⁽²⁾	5.00	5.00 ⁽¹⁾
Hot Line/Warm Line ⁽²⁾	5.00	5.00 ⁽¹⁾
Intercom ⁽²⁾	5.00	N/A
SignalRing (a.k.a. Custom Ring)	5.00	5.00 ⁽¹⁾
Call Forward No Answer - Fixed	3.00	N/A
Call Forward Busy - Fixed	3.00	N/A
Call Forward Additional Paths (Per Path)	3.00	N/A
Remote Call Forwarding	17.00	19.00 ^{(1) (3)}
Call Transfer		
- Residence	N/A	N/A
- Business	5.00	N/A
Outbound Call Block Feature ⁽⁴⁾	5.00	N/A

(T)

- ⁽¹⁾ The installation charge applies when a customer requests a change of the predetermined number to which calls are forwarded.
- ⁽²⁾ Effective June 20, 2008, this service will no longer be available for new installations.
- ⁽³⁾ The installation charge associated with each additional path applies only if the additional path is installed on a subsequent order. The installation charge is not applied for additional paths installed on the same order as the first access path.
- ⁽⁴⁾ Effective January 2, 2018, Outbound Call Block Feature is grandfathered for residential customers. Availability to current residential customers is limited to lines in service at existing locations.

NE2021-21

Received by NPSC
11/2/2021

UNITED TELEPHONE COMPANY OF THE WEST - NEBRASKA
GENERAL EXCHANGE
PRICE LIST

SECTION 12

PAGE: 12.1

RELEASE: 7

ISSUED: October 30, 2020

EFFECTIVE: January 29, 2021

NETWORK SERVICES

IV. RATES (Cont'd)

B. There are no separate installation ... (Cont'd)

Reserved for Future Use

(C)

(D)

(M)

(M)

(M)

(M)

(M) Material moved to Page 12 of this section.

NE2021-01

Received by NPSC
01/15/2021

UNITED TELEPHONE COMPANY OF THE WEST - NEBRASKA
GENERAL EXCHANGE
PRICE LIST

SECTION 12
PAGE: 13
RELEASE: 14

ISSUED: November 1, 2021

EFFECTIVE: November 11, 2021

NETWORK SERVICES

IV. RATES (Cont'd)

- C. The following ExpressTouch features are available at the following monthly rates for the customer group specified. Service Connection Charges or Installation Charges will not be required to place or remove ExpressTouch features on a customer's residence or business individual line service.

	Monthly Per Line Rate			
	<u>Residence</u>	<u>Business</u>	<u>Trunk⁽¹⁾</u>	<u>Centrex⁽²⁾</u>
Return Call FTB1FCC/FTB1FAB	\$5.00	\$5.00	\$5.00	\$5.00
Caller ID - Number Only ⁽³⁾ (includes Anonymous Call Rejection) FTE1FCC(ACR)/FTE1FAB(ACR)	\$10.00	\$10.00	\$10.00	\$10.00
Caller ID with Name (includes Anonymous Call Rejection) FTK1FCC(ACR)/FTK1FAB(ACR)	\$10.00	\$10.00	\$10.00	\$10.00
Repeat Dial FTA1FCC/FTA1FAB	\$5.00	\$5.00	\$5.00	\$5.00
Selective Call Acceptance – GRANDFATHERED FTJ1FCC/FTJ1FAB	\$5.00	\$5.00	\$5.00	\$5.00
Selective Call Forward FTG1FCC/FTG1FAB	\$5.00	\$5.00	\$5.00	\$5.00
Selective Call Rejection FTH1FCC/FTH1FAB	\$5.00	\$5.00	\$5.00	\$5.00
Selective Call Ring (a.k.a. Custom Ring) FTF1FCC/FTF1FAB	\$5.00	\$5.00	\$5.00	\$5.00

(C)

(T)

(1) Includes Key and PBX trunks.

(2) Centrex rates apply only to customers with 4-50 lines. Features for customers with more than 50 Centrex lines will be priced on an Individual Case Basis.

(3) Effective June 20, 2008, this service will no longer be available for new installations.

UNITED TELEPHONE COMPANY OF THE WEST - NEBRASKA
GENERAL EXCHANGE
PRICE LIST

SECTION 12
PAGE: 14
RELEASE: 2

ISSUED: September 28, 2004

EFFECTIVE: October 11, 2004

NETWORK SERVICES

IV. RATES (Cont'd)

D. Network Services Packages

Network Services Packages offer a combination of certain ExpressTouch and Custom Calling Features at rates that provide a monthly savings over the rates that would apply if the features were purchased individually. (T)

The ExpressTouch and Custom Calling Features included in packages are also offered on an individual basis as shown in this section of the tariff. All ExpressTouch and Custom Calling Feature descriptions and regulations are applicable to these packages. (T)

No substitutions will be permitted to the services available in each package. Should a customer no longer want a certain feature contained in a subscribed-to package, the customer may choose another package which includes the features desired or select the desired feature individually.



UNITED TELEPHONE COMPANY OF THE WEST d/b/a CenturyLink
NEBRASKA
GENERAL EXCHANGE PRICE LIST

SECTION 12
PAGE: 15
RELEASE: 19

ISSUED: October 30, 2020

EFFECTIVE: January 29, 2021

NETWORK SERVICES

IV. RATES (Cont'd)

D. Network Services Packages (Cont'd)

<u>Package</u>	<u>Monthly Per Line Rate</u>		
	<u>Residence</u>	<u>Business</u>	
<u>In Touch with Call Forwarding</u> ⁽¹⁾ Enhanced Call Waiting Call Forwarding Three-Way Calling Call Forward Busy - Fixed Call Forward No Answer - Fixed	\$17.00 (I)	\$12.00 (I)	(T)
			(D)
<u>Essentials</u> ⁽²⁾ Enhanced Call Waiting Return Call Three-Way Calling Call Forwarding Call Waiting ID Repeat Dial Caller ID with Name (includes Anonymous Call Rejection) Call Forward Busy - Fixed Call Forward No Answer - Fixed	22.00 (I)	N/A	(T)

(1) Effective June 20, 2008, this service will no longer be available for new installations.

(2) Effective June 20, 2008, this service will no longer be available for new residence installations.

UNITED TELEPHONE COMPANY OF THE WEST d/b/a CenturyLink
NEBRASKA
GENERAL EXCHANGE PRICE LIST

SECTION 12

PAGE: 15.1

RELEASE: 14

ISSUED: October 30, 2020

EFFECTIVE: January 29, 2021

NETWORK SERVICES

IV. RATES (Cont'd)

D. Network Services Packages (Cont'd)

<u>Package</u>	<u>Monthly Per Line Rate</u>		
	<u>Residence</u>	<u>Business</u>	
			(D)
			(D)
<u>Classics Calling Package</u> ⁽¹⁾	\$22.00 (I)	\$17.00 (I)	(T)
Return Call			
Three-Way Calling			
Call Forwarding			
Caller ID with Name (includes Anonymous Call Rejection)			
Call Forward Busy - Fixed			
Call Forward No Answer - Fixed			
			(D)
			(D)

⁽¹⁾ Effective June 20, 2008, this service will no longer be available for new installations.

UNITED TELEPHONE COMPANY OF THE WEST d/b/a CenturyLink
NEBRASKA
GENERAL EXCHANGE PRICE LIST

SECTION 12

PAGE: 16

RELEASE: 6

EFFECTIVE: July 2, 2013

ISSUED: June 20, 2013

NETWORK SERVICES

IV. RATES (Cont'd)

- E. Certain Network Services features are available at the following usage sensitive rates for the customer group specified below:

		<u>Usage Sensitive Rate</u>				
		<u>Residence</u>	<u>Business</u>	<u>Trunk</u>	<u>Centrex</u>	
1.	Return Call Per Activation	\$1.50	\$1.50	N/A	N/A	(1)
2.	Repeat Dial Per Activation	\$1.50	\$1.50	N/A	N/A	(1)
3.	Three-Way Calling Per Activation	\$1.50	\$1.50	N/A	N/A	(1)
4.	Call Trace Per Activation	\$5.00	\$5.00	\$5.00	\$5.00	

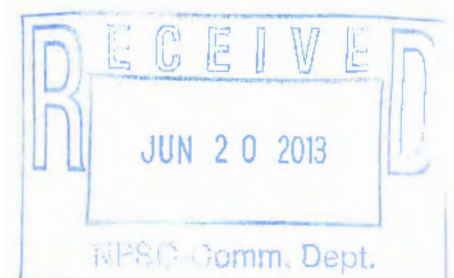

UNITED TELEPHONE COMPANY OF THE WEST - NEBRASKA
GENERAL EXCHANGE
PRICE LIST

SECTION 13

PAGE: 1

RELEASE: 2

ISSUED: February 20, 1996

EFFECTIVE: March 1, 1996

DIGITAL TRUNKING SERVICE

(T)

I. General

(N)

Digital Trunking Service (DTS) is a digital intraexchange service furnished for use with PBX systems and appropriately equipped Key Systems and provides up to 24 digital channels within a single DS1 signal.

II. Definitions

Serving Wire Center denotes the local telephone central office in which telephone communication is established between stations within a specified area.

DTS Facilities include the local loop between the customer's premise and the serving wire center and the central office common equipment.

III. Regulations

- A. DTS is offered only where facilities are available from digital central offices as determined by the company.
- B. 2-Way DID trunk connections are available only in appropriately equipped serving wire centers.
- C. The minimum service period for DTS facility and common equipment is one year. A Termination Liability Charge is applicable at the date of termination and is reduced by 1/12 per month of service to the customer from the date of installation.
- D. The minimum service period for each trunk ordered is one month.
- E. DTS trunks are subject to all general regulations and rates applicable to individual business lines as outlined in the General Exchange Tariff and in United's Federal and other State Tariffs, which include but are not limited to the following:
 - Subscriber Line Charge
 - Exchange Trunk EAS Rates
- F. DTS is not offered in conjunction with the following services:
 - Basic Exchange Service
 - United SwitchLinkSM
 - Feature Groups A, B, C, or D
 - Private Line Access Services and facilities unless otherwise stated in this section.

(N)

RECEIVED

FEB 21 1996

NPSC-Comm. Dept.

UNITED TELEPHONE COMPANY OF THE WEST d/b/a CENTURYLINK
GENERAL EXCHANGE
PRICE LIST

SECTION 13
PAGE: 2
RELEASE: 2

ISSUED: November 30, 2018

EFFECTIVE: December 10, 2018

DIGITAL TRUNKING SERVICE

III. Regulations (Cont'd)

- G. Reserved (D)
- H. Local Measured Service (LMS) is not offered with DTS. (D)
- I. Suspension of service is not available for DTS facilities.
- J. Digital Trunking Service will be available on a digital basis at the network interface on a customer's premises. The customer is required to provide the appropriate multiplexing equipment needed for analog trunk terminations. BellCore Publication 62411 provides the standard High Capability Digital Service Channel Interface specifications.
- K. The Company shall not be responsible if changes in any of its equipment, operations, or procedures utilized in the provision of DTS render any facilities provided by a customer obsolete, require modification or alteration of such equipment or system, or otherwise affect its use or performance. In such instances, the Company will notify the customer, generally a minimum of six months in advance, of the change to allow the customer sufficient time to respond, make any necessary changes, and schedule cooperative testing if needed.
- L. Special Construction is required when a request for DTS requires the construction of facilities and one or more of the following conditions exist:
- The Telephone Company has no other requirement for the facilities requested.
 - It is requested that service be furnished using a type of facility, or via a route, other than that which the Telephone Company would normally utilize in furnishing the requested service.
 - It is requested that construction be expedited, resulting in added cost to the Telephone Company.

Construction charges are contained in Section 3 of the General Exchange Tariff.

Received

NOV 30 2018

MPSC Comm. Dept.

UNITED TELEPHONE COMPANY OF THE WEST - NEBRASKA
GENERAL EXCHANGE
PRICE LIST

SECTION 13
PAGE: 3
RELEASE: 2
EFFECTIVE: July 3, 2005

ISSUED: June 23, 2005

DIGITAL TRUNKING SERVICE

IV. Rates and Charges

	<u>S & E Code</u>	<u>Nonrecurring Charge</u>	<u>Monthly Rate</u>	
Per 24 Channel DTS Facility and Common Equipment ⁽¹⁾	PBVH1FE.DTS	\$560.00	\$195.00	
DTS TRUNKS ⁽³⁾ (Per Trunk)				(C)
- Inward with DID and Rotary Hunt ⁽²⁾	PBX TSRTLC.DTS	\$ 45.00	\$ 20.00	
	KEY TKCTLC.DTS	\$ 45.00	\$ 20.00	
- Outward with Answer Supervision	TSCBLC.DTS	\$ 45.00	\$ 20.00	
- Two-Way with DID, Rotary Hunt, and Answer Supervision ⁽²⁾	PBX TSRTLC.DT2	\$ 45.00	\$ 20.00	
	KEY TKCTLC.DT2	\$ 45.00	\$ 20.00	

(1) A 50% NRC discount applies for each additional DTS facility ordered and installed at the same time.

(2) DID trunk circuit termination is applicable. See Section 11 of the General Exchange Price List.

(3) **The DTS Trunks monthly rate and the applicable EAS Additive monthly rate will appear as a single item on the customer's bill**

(N)
(N)

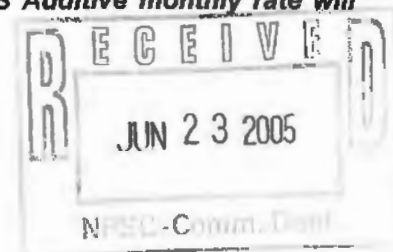

UNITED TELEPHONE COMPANY OF THE WEST - NEBRASKA
GENERAL EXCHANGE
PRICE LIST

SECTION 14

PAGE: 1

RELEASE: 5

ISSUED: September 28, 2004

EFFECTIVE: October 11, 2004

-
- UNITED SWITCHLINK SERVICES (Grandfathered)* (T)
- I. General
- A. United SwitchLink Services are serving wire center based communications services for the transmission of digital signals, over a specifically equipped two-wire or four-wire access line. United SwitchLink Services may be ordered as follows: (T)
- 1) United SwitchLink Service provides asynchronous and synchronous data access at speeds up to and including 19.2 kbps. This service is available in two-wire only. (T)
- 2) United SwitchLink Plus Service provides asynchronous data access at speeds up to and including 19.2 kbps and synchronous data access at speeds up to and including 56 kbps. This service is available in two-wire or four-wire. (T)
- B. United SwitchLink Services are not inherently voice functional. Use of the service is limited to the transmission of digital signals. (T)
- II. Definitions
- United SwitchLink Access Line refers to the non-loaded two-wire or four-wire facility connecting the customer premises to the United SwitchLink Services switching equipment. (T)
- United SwitchLink Services Service Arrangement refers to the equipment required in the serving wire center per line to support data transmission speeds over the United SwitchLink Service Access Line. (T)
- United SwitchLink Services-Serving Wire Center refers to the central office containing United SwitchLink Services switching equipment. (T)
- Serving Wire Center denotes the local telephone central office in which telephone communication is established between stations within a specified area. (T)
- United SwitchLink Services-Serving Area is defined by the technical limitations of each specific service arrangement and in the Company's judgment are necessary to meet the data transmission specifications without excessive degradation of the service. (T)
- United SwitchLink Services Extension Capability refers to the facilities and equipment necessary to extend a United SwitchLink Services Access Line for certain customers who are served by a Serving Wire Center not equipped with United SwitchLink Services Service Arrangement. (T)

* Grandfathered service limited to existing customers at existing locations as of November 9, 2001.



UNITED TELEPHONE COMPANY OF THE WEST - NEBRASKA
GENERAL EXCHANGE
PRICE LIST

SECTION 14

PAGE: 2

RELEASE: 4

ISSUED: September 28, 2004

EFFECTIVE: October 11, 2004

UNITED SWITCHLINK SERVICES (Grandfathered)*

(T)

II. Definitions (Cont'd)

United SwitchLink Services Extension Line refers to a United SwitchLink Services Access Line when the service is provided using the United SwitchLink Services Extension Capability.

(T)

(T)

III. Regulations

A. United SwitchLink Services are provided subject to the availability of appropriately equipped digital serving wire centers and facilities. The Company is under no obligation to provide United SwitchLink Services at a distance from the serving wire center that exceeds the technical limitations of the service, up to 18,000 ft. For customers beyond that limit, special construction charges apply.

(T)

(T)

B. The Company shall not be responsible if changes in any of its equipment, operations, or procedures utilized in the provision of United SwitchLink Services render any facilities provided by a customer obsolete, require modification or alteration of such equipment or system, or otherwise affect its use or performance. In such instances, the Company will notify customers of such changes.

(T)

C. United SwitchLink Service require the use of customer premises equipment for which the subscriber is responsible for obtaining and maintaining. United SwitchLink Plus Service requires compatible data units be utilized at the originating and terminating ends of the transmission to transmit and receive the data at the 56 Kbps speed. The same data unit may be used for either United SwitchLink or United SwitchLink Plus Services. Customer premise equipment associated with United SwitchLink Services must adhere to industry approved standards. The Company is not responsible for the compatibility of the customer premise equipment if the customer selects equipment that does not meet generally approved industry standards.

(T)

(T)

(T)

(T)

D. For United SwitchLink Plus Service transmissions over interexchange facilities, the carrier chosen by the subscriber must be capable of passing 56 Kbps data transmission end-to-end over a digital network.

(T)

E. Service is available on a month-to-month basis with a minimum billing period of one month.

F. Touch-Tone service and equipment is required for each United SwitchLink Services Access Line. Charges for Touch-Tone service and equipment are in addition to all other charges associated with United SwitchLink Services.

(T)

(T)

G. Directory listings will be furnished for United SwitchLink Services in accordance with the regulations set forth in Section 4 of the General Exchange Tariff; however, there is no charge for non-published United SwitchLink Services telephone numbers.

(T)

(T)

* Grandfathered service limited to existing customers at existing locations as of November 9, 2001

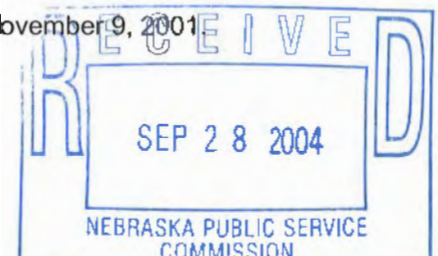

UNITED TELEPHONE COMPANY OF THE WEST - NEBRASKA
 GENERAL EXCHANGE
 PRICE LIST

SECTION 14

PAGE: 3

RELEASE: 4

ISSUED: September 28, 2004

EFFECTIVE: October 11, 2004

UNITED SWITCHLINK SERVICES (Grandfathered)* (T)

III. Regulations (Cont'd)

- H. Temporary suspension of service at the request of the customer is not allowed.
- I. Regulations for Interruptions of Service apply as specified in the General Exchange Tariff.

IV. Rates

	<u>SAE</u>	<u>Monthly</u>	<u>NRC</u>	
A. United SwitchLink Service per 2-Wire Access Line	1FLCSW	\$ 35.00	\$ 35.00	(T)
B. United SwitchLink Plus Service per 2-Wire Access Line	1FLCSW(PL)	\$ 95.00	\$ 35.00	(T)
C. United SwitchLink Plus Service per 4-Wire Access Line	1FLCSW(4)	\$140.00	\$340.94	(T)

Note: United SwitchLink Services access lines utilizing the long distance network will have the applicable Message Telecommunications Service (MTS) toll charges billed to the originating end. MTS toll charges will be rated from the exchange rate center of the United SwitchLink Services-Serving Wire Center. (T)

- D. United SwitchLink Services are subject to all general regulations and rates applicable to individual business line as outlined in the General Exchange Tariff and in United's Federal and other State Tariffs. (T)
- E. Optional Features (e.g., speed dial) are available at the rates provided in the applicable sections of the General Exchange Tariff or the General Exchange Price List.

* Grandfathered service limited to existing customers at existing locations as of November 9, 2001.

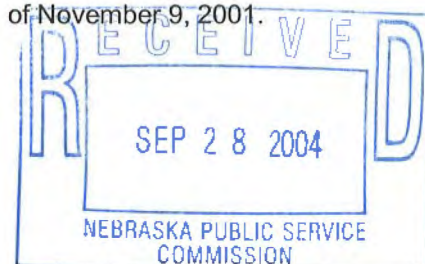

UNITED TELEPHONE COMPANY OF THE WEST - NEBRASKA
GENERAL EXCHANGE
PRICE LIST

SECTION 15
PAGE: 1
RELEASE: 1

ISSUED: December 1, 1992

EFFECTIVE: December 11, 1992

RESERVED FOR FUTURE USE

RECEIVED
NOV 30 1992
ACCT. & ENCL. DEPARTMENT
Nebr. Public Service Commission

UNITED TELEPHONE COMPANY OF THE WEST - NEBRASKA
GENERAL EXCHANGE
PRICE LIST

SECTION 16
PAGE: 1
RELEASE: 1

ISSUED: December 1, 1992

EFFECTIVE: December 11, 1992

RESERVED FOR FUTURE USE

RECEIVED

NOV 30 1992

ACCT. & ENCL. DEPARTMENT
Nebr. Public Service Commission

UNITED TELEPHONE COMPANY OF THE WEST - NEBRASKA
GENERAL EXCHANGE
PRICE LIST

SECTION 17

PAGE: 1

RELEASE: 42

ISSUED: September 28, 2004

EFFECTIVE: October 11, 2004

SPECIAL PROMOTIONS

I. Network Services Promotion

A. During the period January 2, 2004, through March 31, 2004, business customers with 4 lines or fewer will receive a \$20 credit when they subscribe to one of the following service combinations:

- 1) Sprint Solutions Business Package Sure Solutions II plus the Telephone Company's deregulated Voicemail service and any Sprint Communications Company L.P. long distance service; or (T)
- 2) Rotary Line service and Sprint Classics Calling Package plus the Telephone Company's deregulated Voicemail service and any Sprint Communications Company L.P. long distance service. (T)

Customers must retain the selected services for a minimum of two months to receive the credit. The credit will be applied to the customer's second full month's invoice that is issued after subscription to the qualifying services.

This promotion will be advertised through outbound telemarketing and will be extended to inbound customers upon request.

B. During the promotion period January 2, 2004, through March 31, 2004, when residential customers contact Sprint LTD to request that the telephone number associated with their individual access line service be ported to another service provider, Sprint LTD will waive one month's charges for Call Forward Busy/Call Forward No Answer when customers agree to retain their access line service and subscribe to or retain the Call Forward Busy/Call Forward No Answer feature.

C. During the period March 1, 2004, through May 31, 2004, Sprint will waive all service connection charges that are otherwise applicable, when new business customers establish an account with four lines or less and subscribe to one of the following: 1) an access line or 2) any Sprint Solutions Business Package plus any Sprint Communications Company, L.P. long distance service. In addition, the customer will receive a credit equal to the monthly recurring charges on their first month's bill for all promotional services installed. Customers subscribing to services under this promotion who discontinue service within ninety days of installation will be assessed all service connection charges originally waived under the promotion. (T)

D. During the period March 1, 2004, through May 31, 2004, Sprint will waive all service connection charges that are otherwise applicable for the installation of a new access line when existing business customers with four lines or less order any Sprint Solutions Business Package and any Sprint Communications Company, L.P. long distance service. Customers subscribing to services under this promotion who discontinue service within ninety days of installation will be assessed all services charges originally waived under the promotion. (T)

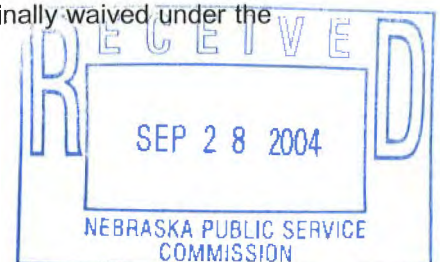

UNITED TELEPHONE COMPANY OF THE WEST - NEBRASKA
GENERAL EXCHANGE
PRICE LIST

SECTION 17

PAGE: 2

RELEASE: 2

ISSUED: June 18, 2004

EFFECTIVE: June 30, 2004

SPECIAL PROMOTIONS

I. Network Services Promotion (Continued)

E. During the promotion period April 1, 2004, through June 29, 2004, existing business customers that do not have a Sprint SolutionsSM Package will receive a credit equal to one monthly recurring charge when they subscribe to Economy Solution plus any Sprint Communications Company, L.P. long distance service. The credit will be applied on the subsequent month after subscription.

F. During the promotion period, April 1, 2004, through June 29, 2004, existing business customers will receive a \$25 credit when they subscribe to one of the following service combinations:

- 1) Sprint SolutionsSM Business Package Connected Solution plus the Telephone Company's **Voicemail** service and any Sprint Communications Company L.P. long distance service; or (T)
- 2) Rotary Line Service and Sprint ClassicsSM Calling Package plus the Telephone Company's **Voicemail** service and any Sprint Communications Company L.P. long distance service. (T)

Customers must retain the selected services for a minimum of two months to receive the credit. The credit will be applied to the customer's second full month invoice after subscription to the qualifying service.

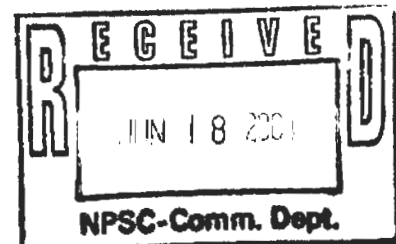

UNITED TELEPHONE COMPANY OF THE WEST - NEBRASKA
GENERAL EXCHANGE
PRICE LIST

SECTION 17
PAGE: 3
RELEASE: 5

ISSUED: July 21, 2005

EFFECTIVE: July 31, 2005

SPECIAL PROMOTIONS

I. Network Services Promotion (Continued)

- J. During the promotion period August 16, 2004, through October 31, 2004, business customers with four lines or fewer, who contact Sprint to disconnect their Sprint Solutions Package plus any Sprint Communications L.P. long distance plan, will be offered a \$20 bill credit when they agree to retain their Sprint Solutions Package plus Sprint Long Distance plan. The credit will appear on the customer's next invoice.
- K. During the promotional period January 1, 2005 through **October 27, 2005**, business customers with four lines or fewer, who subscribe to Sure Solution II plus Voicemail and any Sprint Communications Company, L.P. long distance plan will receive a \$15 credit on their next month's bill. (C)
- L. During the promotional period, January 1, 2005 through **October 27, 2005**, business customers who contact Sprint to request that the telephone number associated with their individual access line service or Rotary Access Line service be ported to another service provider, may receive a \$5 credit per month for 3 months. Sprint will offer a \$5 credit per month for 3 months for each access line, up to a maximum of five, when customers agree to retain their access line service. The credit will be applied on the customer's next three invoices. (C)
- M. During the promotional period, January 1, 2005 through **October 27, 2005**, new business customers with four lines or fewer, who subscribe to Economy Solution plus Voicemail, Economy Solution II, Sprint Priority Solution plus any LD Service, Sure Solution II plus any LD Service, an Access Line with Rotary plus Sprint Classics Calling Package plus any LD Service, an Access Line with Rotary plus Sprint Classics Calling Package plus any LD Service plus Voicemail or Rotary Classic Solution will have all applicable installation charges waived. Customers subscribing to services under this promotion who discontinue service within ninety days of installation will be assessed all charges originally waived under the promotion. (C)

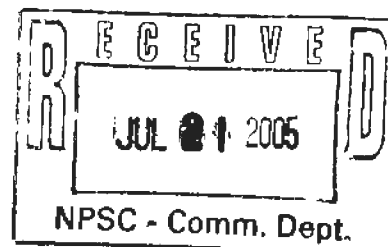

UNITED TELEPHONE COMPANY OF THE WEST - NEBRASKA
GENERAL EXCHANGE
PRICE LIST

SECTION 17

PAGE: 5

RELEASE: 2

ISSUED: June 6, 2005

EFFECTIVE: June 16, 2005

SPECIAL PROMOTIONS

I. Network Services Promotion (Continued)

O. During the period beginning May 2, 2005, through July 30, 2005, existing residential customers subscribing to the following service(s) who submit a referral via the Sprint Internet website will receive a \$25 bill credit if the referral results in the activation of a qualifying service by the referred customer within sixty days of the referral. The referred customer must be an existing Sprint residential customer who, upon referral, subscribes to one of the following:

- 1) Sprint Core Solution Package with Sprint Communications Company L.P. Sprint Solutions Unlimited Long Distance,
- 2) Sprint Core Solutions Plus Package with Sprint Communications Company L.P. Sprint Solutions Unlimited Long Distance,
- 3) Sprint Personal II Solution Package with Sprint Communications Company L.P. Sprint Solutions Unlimited Long Distance,
- 4) Sprint Home II Solution Package with one required Premium Enhance Service (LineGuard/Data LineGuard, CPE Warranty Plus or VoiceMail) and Sprint Communications Company L.P. Sprint Solutions Unlimited Long Distance,
- 5) The Company's DSL service,
- 6) Dish Network Service offered through Sprint LTD.

The referring customer will receive the bill credit within 60 days of the referred customer subscribing to the service. Multiple credits may be received by the referring customer, with one credit rendered per bill cycle.

P. During the promotional period June 16, 2005 through September 13, 2005, Sprint will waive all nonrecurring installation and/or service charges that are otherwise applicable when a business customer establishes a new account and subscribes to Basic Business Local Service (B1), Key Trunk, ISDN-BRI, ISDN-PRI, Centrex, Frame Relay, PBX Trunk or Translink under the same order.

Customers subscribing to services under this promotion who discontinue service within one year of installation will be assessed all charges originally waived under the promotion.

(N)

(N)

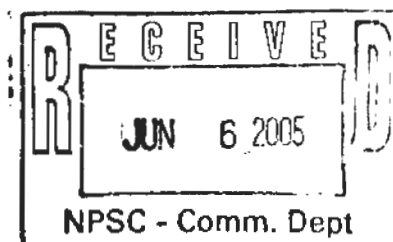

UNITED TELEPHONE COMPANY OF THE WEST - NEBRASKA
GENERAL EXCHANGE
PRICE LIST

SECTION 17
PAGE: 6
RELEASE: 4

ISSUED: December 2, 2005

EFFECTIVE: December 12, 2005

SPECIAL PROMOTIONS

I. Network Services Promotion (Continued)

- Q. The purpose of this filing is to offer a promotion to business customers. During the promotional period September 14, 2005 through December 14, 2005, Sprint will waive all nonrecurring installation and/or service connection charges that are otherwise applicable when a business customer establishes a new account and subscribes to Business Local Service (B1), Key Trunk, ISDN-BRI, ISDN-PRI, Centrex II, Enhanced Frame Relay, PBX Trunk or Translink under the same order. The customer's initial monthly charges must be at least \$100.00 to qualify for participation in this promotion.

Customers subscribing to services under this promotion who discontinue service within one year of installation will be assessed all charges originally waived under the promotion.

This promotion will be advertised through direct mail and the Company's internet site.

- R. Effective September 19, 2005 through December 31, 2005, the Company will waive all nonrecurring charges and service connection charges that are otherwise applicable for the installation of service when residential customers whose premises were destroyed or partially destroyed by Hurricane Katrina establish service in any location in the Company's serving territory.

- S. During the promotional period October 27, 2005 through January 24, 2006, business customers with four lines or fewer, who subscribe to a new Sure Solution II package with any Sprint Communications Company, L.P. **or Sprint Long Distance, Inc.** long distance plan; Sprint Priority Solution with Sprint Communications Company L.P. **or Sprint Long Distance, Inc.** Sprint Small Business Unlimited Solutions II Long Distance Plan; or Rotary Classic Solutions will receive a \$25.05 credit on their next month's bill. (C)

This promotion will be advertised through inbound telemarketing.

- T. During the promotional period October 27, 2005 through January 24, 2006, business customers with four lines or fewer, who subscribe to a new Economy Bundle II A package or Rotary Classics Custom Calling Package with any Sprint Communications Company, L.P. **or Sprint Long Distance, Inc.** long distance plan will receive a \$15.05 credit on their next month's bill. (C)

This promotion will be advertised through inbound telemarketing.

- U. During the promotional period October 27, 2005 through January 24, 2006, business customers who contact Sprint to request that the telephone number associated with their individual access line service, Rotary Access Line service or any Bundle be ported to another service provider, may receive a \$6.00 credit per B1 line up to four lines per month for 3 months when customers agree to retain their access line service. The credit will be applied on the customer's next three invoices.

This promotion will be advertised through inbound telemarketing.

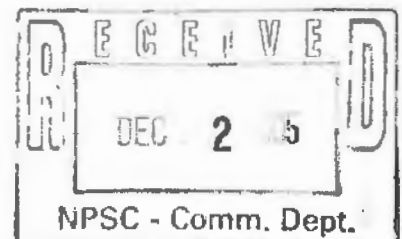

UNITED TELEPHONE COMPANY OF THE WEST - NEBRASKA
GENERAL EXCHANGE
PRICE LIST

SECTION 17

PAGE: 6.1

RELEASE: 4

ISSUED: April 14, 2006

EFFECTIVE: April 25, 2006

SPECIAL PROMOTIONS

I. Network Services Promotion (Continued)

- V. During the promotional period October 27, 2005 through January 24, 2006, when a business customer establishes a new account and subscribes to Business Local Service (B1) and also subscribes to one of the following: Economy Bundle II A package, Sure Solution II package, Sprint Priority Solution package or Rotary Classic Solution package, the Company will waive all nonrecurring installation and/or service connection charges that are otherwise applicable with the B1 service. This offer cannot be combined with any other promotional offer.

This promotion will be advertised through inbound telemarketing.

- W. The purpose of this filing is to offer a promotion to business customers. During the promotional period January 3, 2006 through April 2, 2006, the Company will waive all nonrecurring installation and/or service charges that are otherwise applicable when a business customer establishes a new account and subscribes to Business Local Service (B1), Key Trunk, ISDN-BRI, ISDN-PRI, Centrex, Frame Relay, PBX Trunk or Translink under the same order. The customer's initial monthly charges must be at least \$75.00 to qualify for participation in this promotion.

Customers subscribing to services under this promotion who discontinue service within one year of installation will be assessed all charges originally waived under the promotion.

This promotion will be advertised through direct mail and the Company's internet site.

- X. During the period January 27, 2006 through **June 30, 2006**, business customers with four lines or fewer, who subscribe to one of the following services will receive a \$25.15 credit on their next month's bill. (T)
- 1) A new Sure Solution II package with any Sprint Communications Company L.P. or Embarq Communications, Inc. long distance plan; or
 - 2) A new Sprint Priority Solution package with Sprint Communications Company L.P. or Embarq Communications, Inc. Sprint Small Business Unlimited Solutions II Long Distance Plan; or
 - 3) A new Rotary Classic Solution package.

- Y. During the period January 27, 2006 through **June 30, 2006**, business customers with four lines or fewer, who subscribe to one of the following services will receive a \$15.15 credit on their next month's bill: (T)
- 1) A new Economy Bundle II A package plus any Sprint Communications Company L.P. or Embarq Communications, Inc. long distance plan; or
 - 2) A new Business Flat Rate Service with Rotary Hunt Service, Sprint Classics Calling Package plus any Sprint Communications Company L.P. or Embarq Communications, Inc. long distance plan.

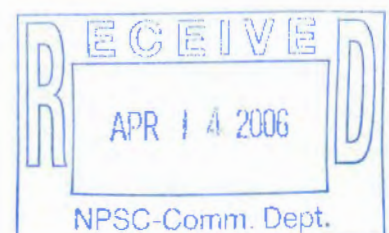

UNITED TELEPHONE COMPANY OF THE WEST - NEBRASKA
GENERAL EXCHANGE
PRICE LIST

SECTION 17

PAGE: 6.2

RELEASE: 4

ISSUED: April 14, 2006

EFFECTIVE: April 25, 2006

SPECIAL PROMOTIONS

I. Network Services Promotion (Continued)

Z. During the period January 27, 2006 through April 24, 2006, business customers who contact the Company to request that the telephone number associated with one of the following services be ported to another service provider, will receive a \$5.50 credit per B1 line up to four lines per month for 3 months when customers agree to retain their access line service:

- 1) Individual access line service (B1) with or without Rotary Hunt Service;
- 2) Any Sprint Solutions Package

The credit will be applied on the customer's next three invoices.

AA. During the period January 27 through **June 30, 2006**, when a business customer establishes a new account and subscribes to Business Local Service (B1) and also subscribes to one of the following services, the Company will waive all nonrecurring installation and/or service charges that are otherwise applicable with the B1 service: (T)

- 1) Economy Bundle II A package;
- 2) Sure Solution II package;
- 3) Sprint Priority Solution package;
- 4) Rotary Classics Solution package

This offer cannot be combined with any other promotional offer.

AB. During the period February 16, 2006 through May 31, 2006, residence customers who subscribe to Sprint Home II Solution bundle plus Sprint Communications Company L.P. or Embarq Communications, Inc. Sprint Solutions Unlimited Market Test – Option 2 or Sprint High Speed Internet, will receive a \$10.00 discount on the Home II Solution bundle for 12 months. Customers must be contacted by the Company or must contact the Company and request this promotion.

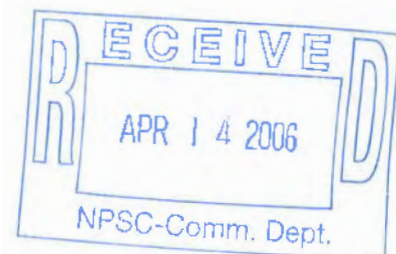

UNITED TELEPHONE COMPANY OF THE WEST - NEBRASKA
GENERAL EXCHANGE
PRICE LIST

SECTION 17
PAGE: 6.3
RELEASE: 7

ISSUED: April 20, 2007

EFFECTIVE: May 1, 2007

SPECIAL PROMOTIONS

- AC. During the period April 3, 2006 through December 31, 2006, the Company will waive all nonrecurring installation and/or service charges that are otherwise applicable when a business customer establishes a new account and subscribes to Business Flat Rate, Key Trunk, PBX Trunk, ISDN-BRI, ISDN-PRI, Centrex Service II, Frame Relay, or Translink under the same order. The customer's initial monthly charges must be at least \$70 and the customer must commit to a minimum of a one year term in order to qualify for participation in this promotion. Charges for all regulated and non-regulated services, including all applicable taxes, surcharges and other fees, contribute towards the qualifying monthly charges. Customers subscribing to services under this promotion who discontinue service within one year of installation will be assessed all charges originally waived under the promotion.
- AD. During the period April 3, 2006 through December 31, 2006, the Company will waive all nonrecurring installation and/or service charges that are otherwise applicable when a business customer establishes a new account and subscribes to ATM, Digilink, or Lightlink under the same order. The customer's initial monthly charges must be at least \$70 and the customer must commit to a minimum of a three year term in order to qualify for participation in this promotion. Charges for all regulated and non-regulated services, including all applicable taxes, surcharges and other fees, contribute towards the qualifying monthly charges. Customers subscribing to services under this promotion who discontinue service within three years of installation will be assessed all charges originally waived under the promotion.
- AE. During the period April 3, 2006 through December 31, 2006, business customers may be eligible for a one-time invoice credit. To be eligible, customers must (1) be contacted by the Company or contact the Company and request this promotion and subscribe to any combination of business services for which the total monthly charges equal or exceed \$50 or (2) contact the Company to request that their service(s) be disconnected and agree to retain their service(s), with the customer's continued total monthly charges equal to or exceeding \$50. Charges for all regulated and non-regulated services, including all applicable taxes, surcharges and other fees, contribute towards the qualifying monthly charges.

A one-time credit amount, as specified below, will be reflected on the customer's first invoice.

<u>Total Monthly Charges</u>	<u>Credit Amount</u>
\$50 - \$100	\$ 50.00
Over \$100 - \$200	\$ 100.00
Over \$200 - \$300	\$ 200.00
Over \$300 - \$400	\$ 300.00
Over \$400 - \$500	\$ 400.00
Over \$500 - \$600	\$ 500.00
Over \$600 - \$700	\$ 600.00
Over \$700 - \$800	\$ 700.00
Over \$800 - \$900	\$ 800.00
Over \$900 - \$1,000	\$ 900.00
Over \$1,000	\$1,000.00

- AF. During the period June 12, 2006 through December 31, 2007, the Company will waive all nonrecurring installation and/or service connection charges that are otherwise applicable for installation of a Solutions-Business Package. (C)
(T)

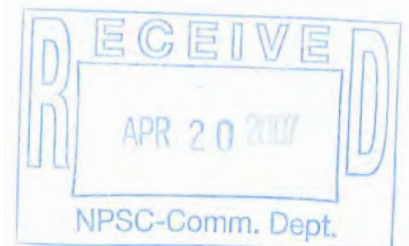

UNITED TELEPHONE COMPANY OF THE WEST - NEBRASKA
GENERAL EXCHANGE
PRICE LIST

SECTION 17
PAGE: 6.4
RELEASE: 3
EFFECTIVE: June 25, 2007

ISSUED: June 15, 2007

SPECIAL PROMOTIONS

AG. During the period June 19, 2006 through September 16, 2006, existing business customers with five or more lines or trunks (including T1 based voice channel services such as ISDN-PRI and Digital Trunking Service) who add ISDN-BRI, Frame Relay, ATM, Digilink, Translink or Lightlink to their account, will receive a bill credit for the first month's service for each qualified service added to the customer's account. There is no limit to the number of qualified services that a customer can add to their account nor is there a limit to the number of times a customer can qualify for the bill credit during the promotional period. The bill credit for qualified services installed during this promotional period will be reflected on the customer's first bill immediately following the installation of qualified services. The first month's service for which the customer is credited will count as the first month of service where a minimum service period or term commitment period are applicable. If a customer discontinues service for which credit was issued prior to the end of required service period, credits issued under this promotion will not be rescinded, and the customer is subject only to the applicable minimum service period or termination liability charges that are normally applicable for that service.

AH. During the period **June 25, 2007** through December 31, 2007, business customers who are subscribed to Business One Party Flat Rate service, Solutions Packages or Connection Central Bundle, may be eligible for **two bill credits** when they contact the Company to advise that they have received a better priced offer for the same or comparable service(s) from a competitor. The customer's charges for the specific service(s) for which they have received the offer must equal or exceed \$50 (excluding long distance, taxes, surcharges, and other fees). The credits, as specified below, will be reflected on the customer's bill **for the first and third month bills following the customer's acceptance of this promotion.**

<u>Monthly Charges</u>	<u>Credit Amount</u>
Over \$50 - \$150	\$ 50.00
Over \$150	\$ 100.00

AI. During the period **June 25, 2007** through December 31, 2007, business customers who subscribe to Business One Party Flat Rate service, Solutions Packages or Connection Central Bundle, may be eligible for **two bill credits** when they contact the Company to disconnect service(s) and agree to retain their service(s) with the Company. The customer's charges for the specific service(s) must equal or exceed \$50 (excluding long distance, taxes, surcharges, and other fees). The credits, as specified below, may be up to this amount, but will not exceed the customer's monthly charges (excluding long distance, taxes, surcharges, and other fees) and will be reflected on the customer's bill **or the first and third month bills following the customer's acceptance of this promotion.**

<u>Monthly Charges</u>	<u>Credit Amount</u>
\$0 - \$50	\$ 50.00
Over \$50 - \$100	\$ 100.00
Over \$100 - \$200	\$ 200.00
Over \$200 - \$300	\$ 300.00
Over \$300 - \$400	\$ 400.00
Over \$400	\$ 500.00



UNITED TELEPHONE COMPANY OF THE WEST - NEBRASKA
GENERAL EXCHANGE
PRICE LIST

SECTION 17

PAGE: 6.5

RELEASE: 7

ISSUED: February 9, 2009

EFFECTIVE: February 19, 2009

SPECIAL PROMOTIONS

- AJ. During the period **February 19, 2009** through December 31, 2009, business customers who subscribe to Business Flat Rate, Key Trunk, and/or PBX Trunk service may be eligible for waiver of all service connection charges (excluding inside wire, construction, or CPE installation) that are otherwise applicable. To receive a waiver, customers who are contacted by the Company or who contact the Company and request this promotion must subscribe to one of the qualifying services, and **commit to one year of service for the services described above. Customers subscribing to services under this promotion who discontinue service prior to meeting the one year commitment will be assessed all charges originally waived under the promotion.** There is no limit to the number of times a customer can receive this promotion provided that the customer meets the required **commitment** level with each subsequent order. (C)
- AK. During the period January 1, 2007 through December 31, 2009, business customers who subscribe to Centrex Service II and/or ISDN BRI service may be eligible for waiver of all nonrecurring installation and service connection charges (excluding inside wire, construction, or CPE installation) that are otherwise applicable. To receive a waiver, customers who are contacted by the Company or who contact the Company and request this promotion must subscribe to one of the qualifying services, and must commit to a minimum of a one year term. Customers subscribing to services under this promotion who discontinue service within one year of installation will be assessed all charges originally waived under the promotion. There is no limit to the number of times a customer can receive this promotion provided that the customer meets the required commitment level with each subsequent order. (C)
- AL. During the period **February 19, 2009** through December 31, 2009, business customers who subscribe to ISDN PRI, Frame Relay, ATM, Digilink, Translink, and/or Lightlink service may be eligible for waiver of all nonrecurring installation and service connection charges (excluding inside wire, construction, or CPE installation) that are otherwise applicable. To receive a waiver, customers who are contacted by the Company or who contact the Company and request this promotion must subscribe to one of the qualifying services, and must commit to a minimum of a **one** year term. Customers subscribing to services under this promotion who discontinue service within **one year** of installation will be assessed all charges originally waived under the promotion. There is no limit to the number of times a customer can receive this promotion provided that the customer meets the required commitment level with each subsequent order. (C)
- AM. Reserved For Future Use
- AN. Beginning February 1, 2007 through December 31, 2007, new business customers who are contacted by the Company or who contact the Company and request this promotion when subscribing to Complete Business Bundle or Connection Central Bundle will receive a \$75 bill credit when they also subscribe to High-speed Internet under a two year term commitment. The bill credit will appear on the third month's bill. (C)

- 9 2009

UC-Comm. Prot.

UNITED TELEPHONE COMPANY OF THE WEST - NEBRASKA
GENERAL EXCHANGE
PRICE LIST

SECTION 17

PAGE: 6.6

RELEASE: 3

ISSUED: April 20, 2007

EFFECTIVE: May 1, 2007

SPECIAL PROMOTIONS

AM. During the period February 15, 2007 through **June 15, 2007**, new and existing business customers who are contacted by the Company or who contact the Company and request this promotion may be eligible for a one-time bill credit when they subscribe to one or more of the following qualifying services: ISDN-BRI, ISDN-PRI, Frame Relay, ATM, Digilink, Translink, Lightlink, and Digital Trunking Service. To be eligible, customers must establish a new account or add to an existing account and order a qualifying service(s), with a resulting monthly spend of \$300 or more. Charges for all regulated and non-regulated services (excluding taxes, surcharges and other fees) contribute towards the monthly spend. The bill credit will be issued for the first month's charges for each qualified service added to the customer's account under this promotion. (C)

There is no limit to the number of qualifying services that a customer can subscribe to under this promotion, nor is there a limit to the number of times a customer can order additional qualifying services and qualify for the bill credit during the promotional period.

The first month's service for which credit will be issued will count as the first month of service under the minimum service period or term commitment period. If a customer discontinues service for which credit was issued prior to the end of required service period, credits issued under this promotion will not be rescinded; however, customers who discontinue service prior to the end of the minimum service or term commitment period are responsible for the termination liability charges normally applicable for that service.

The Company will also issue a bill credit for business Key Trunks and PBX Trunks when new customers who subscribe to one of the qualifying services listed above also subscribe to business Key and/or PBX trunks on the same order, provided that the total monthly spend for all of the services ordered is at least \$300 per month.

AN. During the period April 9, 2007 through December 31, 2007, new business customers may be eligible for a one-time bill credit when they subscribe to one or more of the following qualifying services: Business Flat Rate, Key Trunk, PBX Trunk, Centrex Service II, ISDN-PRI, PRI-Bundle, and Digital Trunking Service. To be eligible, customers must establish a new account and order a qualifying service(s) under a three year or more term commitment with a resulting monthly spend of \$300 or more. Charges for all qualifying services (excluding taxes, surcharges and other fees) contribute towards the monthly spend. All nonrecurring installation and service connection charges normally applicable will also be waived under this promotion (excluding inside wire, construction, or CPE installation).

The credit, as specified below, will be reflected on the customer's bill in the next full month's billing cycle.

<u>Qualifying Services Monthly Charges</u>	<u>Credit Amount</u>
\$300 - \$350	\$ 300
Over \$350 - \$400	\$ 400
Over \$400 - \$450	\$ 400
Over \$450 - \$500	\$ 500
Over \$500 - \$550	\$ 500
Over \$550 - \$600	\$ 600

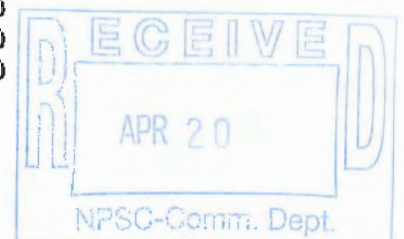

UNITED TELEPHONE COMPANY OF THE WEST - NEBRASKA
GENERAL EXCHANGE
PRICE LIST

SECTION 17

PAGE: 7

RELEASE: 1

ISSUED: March 30, 2007

EFFECTIVE: April 9, 2007

SPECIAL PROMOTIONS

AN. During the period April 9, 2007 through December 31, 2007 ... (Continued)

<u>Qualifying Services Monthly Charges</u>	<u>Credit Amount</u>
Over \$600 - \$650	\$ 600
Over \$650 - \$700	\$ 700
Over \$700 - \$750	\$ 700
Over \$750 - \$800	\$ 800
Over \$800 - \$850	\$ 800
Over \$850 - \$900	\$ 900
Over \$900 - \$950	\$ 900
Over \$950 - \$1,000	\$1,000
Over \$1,000 - \$1,050	\$1,000
Over \$1,050 - \$1,100	\$1,100
Over \$1,100 - \$1,150	\$1,100
Over \$1,150 - \$1,200	\$1,200
Over \$1,200 - \$1,250	\$1,200
Over \$1,250 - \$1,300	\$1,300
Over \$1,300 - \$1,350	\$1,300
Over \$1,350 - \$1,400	\$1,400
Over \$1,400 - \$1,450	\$1,400
Over \$1,450 - \$1,500	\$1,500
Over \$1,500 - \$1,550	\$1,500
Over \$1,550 - \$1,600	\$1,600
Over \$1,600 - \$1,650	\$1,600
Over \$1,650 - \$1,700	\$1,700
Over \$1,700 - \$1,750	\$1,700
Over \$1,750 - \$1,800	\$1,800
Over \$1,800 - \$1,850	\$1,800
Over \$1,850 - \$1,900	\$1,900
Over \$1,900 - \$1,950	\$1,900
Over \$1,950 - \$2,000	\$2,000
Over \$2,000	\$2,000

There is no limit to the number of qualifying services that a customer can subscribe to under this promotion.

The first full month's service for which credit will be issued will count as the first month of service under the term commitment period. If a customer discontinues service for which credit was issued prior to the end of required service period, credits issued under this promotion will not be rescinded; however, customers who discontinue service prior to the end of the term commitment period are responsible for the termination liability charges, where applicable, for the service(s) that are prematurely disconnected.

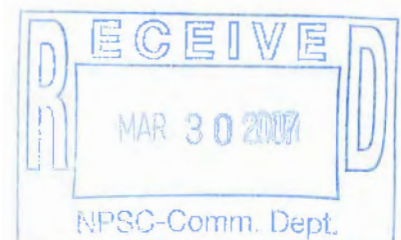

UNITED TELEPHONE COMPANY OF THE WEST - NEBRASKA
GENERAL EXCHANGE
PRICE LIST

SECTION 17

PAGE: 8

RELEASE: 2

ISSUED: June 15, 2007

EFFECTIVE: June 25, 2007

SPECIAL PROMOTIONS

- AO. During the period **June 25, 2007** through December 31, 2007, business customers who are subscribed to Key Trunks, PBX Trunks, ISDN-BRI, ISDN-PRI, Frame Relay Service, analog Private Line Services, Digilink, Translink, Lightlink, Digital Trunking Service, Centrex Service II or PRI Bundle will be eligible for **two bill credits** when they contact the Company to inform them that they have received a better priced offer for the same or comparable service(s) from a competitor. The customer's charges for the specific service(s) for which they have received the offer must equal or exceed \$50 (excluding long distance, taxes, surcharges, and other fees). The **credits**, as specified below, will be reflected on the customer's bill **for the first and third month bills following the customer's acceptance of this promotion.**

<u>Monthly Charges</u>	<u>Credit Amount</u>
\$50 - \$ 99.99	\$ 50
\$100 - \$ 199.99	\$ 100
\$200 - \$ 299.99	\$ 200
\$300 - \$ 399.99	\$ 300
\$400 - \$ 499.99	\$ 400
\$500 - \$ 599.99	\$ 500
\$600 - \$ 699.99	\$ 600
\$700 - \$ 799.99	\$ 700
\$800 - \$ 899.99	\$ 800
\$900 - \$1,000.00	\$ 900

- AP. During the period **June 25, 2007** through December 31, 2007, business customers who subscribe to Key Trunks, PBX Trunks, ISDN-BRI, ISDN-PRI, Frame Relay Service, analog Private Line Services, Digilink, Translink, Lightlink, Digital Trunking Service, Centrex Service II or PRI Bundle will be eligible for **two bill credits** when they contact the Company to disconnect service(s) and agree to retain their service(s) with the Company. The customer's charges for the specific service(s) must equal or exceed \$50 (excluding long distance, taxes, surcharges, and other fees). The **credits**, as specified below, may be up to this amount, but will not exceed the customer's monthly charges (excluding long distance, taxes, surcharges, and other fees) and will be reflected on the customer's bill **for the first and third month bills following the customer's acceptance of this promotion.**

<u>Monthly Charges</u>	<u>Credit Amount</u>
\$50 - \$ 99.99	\$ 99.99
\$100 - \$ 199.99	\$ 199.99
\$200 - \$ 299.99	\$ 299.99
\$300 - \$ 399.99	\$ 399.99
\$400 - \$ 499.99	\$ 499.99
\$500 - \$ 599.99	\$ 599.99
\$600 - \$ 699.99	\$ 699.99
\$700 - \$ 799.99	\$ 799.99
\$800 - \$ 899.99	\$ 899.99
\$900 - \$1,000.00	\$ 1,000.00

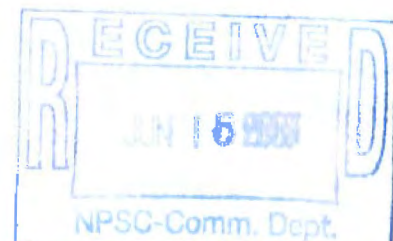

UNITED TELEPHONE COMPANY OF THE WEST - NEBRASKA
GENERAL EXCHANGE
PRICE LIST

SECTION 17

PAGE: 9

RELEASE: 3

ISSUED: December 21, 2007

EFFECTIVE: January 1, 2008

SPECIAL PROMOTIONS

AQ. During the period August 10, 2007 through November 7, 2007, residence customers who contact the Company or are contacted by the Company and who subscribe to Simple Solution plus Embarq Communications, Inc. Solutions Unlimited - Option 4, will receive a one-time credit of the monthly recurring charge for Simple Solution on their local phone bill. The credit will be on the customer's first month's billing. The customer's account must be in good standing to receive this offer.

AR. During the period September 4, 2007 through December 31, 2007, business customers who are not currently subscribed to the Company's High-speed Internet may be eligible for a waiver of the monthly recurring charge for Complete Business Bundle. To be eligible, customers must be contacted by the Company or contact the Company and request this promotion, and subscribe to Complete Business Bundle and High-speed Internet under a two year term commitment.

A waiver of the monthly recurring charge for Complete Business Bundle will apply from the date of installation through December 31, 2007. This waiver only applies to the initial bundle ordered per location.

AS. **Beginning January 1, 2008, a bill message and/or insert will be sent quarterly to all business customers with 99 lines/trunks or fewer, notifying them of their eligibility for a \$10 invoice credit when they contact the Company to discuss their service needs. Customers who contact the Company from January 1, 2008 through December 31, 2008, and notify the Company representative that they are calling in response to the promotional offer will receive a \$10 credit on their next invoice when they discuss their current services and service needs with the Company representatives to ensure they are subscribed to the most appropriate services for their business needs.**

(N)

Customers who respond to this promotion and receive the \$10 invoice credit will be eligible to participate in this promotional offer again six months after the first credit is issued, as long as the six-month period ends before December 31, 2008. To receive a second invoice credit, customers must contact the Company, notify the Company representative that they are responding to the promotional offer, and request an additional review of their services and business needs.

AT. During the period January 1, 2008 through June 30, 2008, business customers who are not currently subscribed to the Company's High-speed Internet may be eligible for a one-time waiver of the monthly recurring charge for Complete Business Bundle or Connection Central Bundle. To be eligible, customers who are contacted by the Company or contact the Company and request this promotion must subscribe to (1) Complete Business Bundle or Connection Central Bundle and (2) High-speed Internet under a two year term commitment.

The one-time waiver of the monthly recurring charge for Complete Business Bundle or Connection Central Bundle will apply for the first full month's service after the service is installed. This waiver only applies to the initial bundle ordered per location.

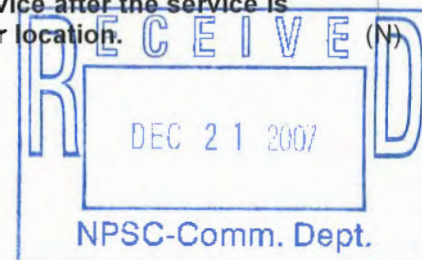

UNITED TELEPHONE COMPANY OF THE WEST - NEBRASKA
GENERAL EXCHANGE
PRICE LIST

SECTION 17
PAGE: 10
RELEASE: 5

ISSUED: December 22, 2008

EFFECTIVE: January 1, 2009

SPECIAL PROMOTIONS

AU. During the period January 1, 2008 through December 31, 2008, when business customers who are contacted by the Company or who contact the Company and request this promotion subscribe to MultiLine Bundle or any Solutions-Business Package, the Company will waive all applicable service charges.

AV. During the period January 14, 2008 through May 12, 2008, business customers may be eligible for a one-time or two-time waiver of monthly charges for Enhanced Frame Relay Service. To be eligible, customers who are contacted by the Company or contact the Company and request this promotion must subscribe to Enhanced Frame Relay Service and the Company's non-regulated Dedicated IP service offering under a three-year or five-year term commitment.

When a customer adds non-regulated Dedicated IP service to a new location under a three-year or greater term plan, the Company will waive the monthly recurring charges for the Frame Relay Access Line and Permanent Virtual Circuit (PVC) for the first month after the service installation. When a customer adds non-regulated Dedicated IP service and non-regulated Managed Network Service Services to a new location under a five-year term plan, the Company will waive the monthly recurring charges for the Frame Relay Access Line and the Permanent Virtual Circuit (PVC) for two months, with the waivers appearing on the customer's first invoice after installation and the last invoice issued under the term plan.

AW. During the period January 14, 2008 through May 12, 2008, existing business customers who currently subscribe to the Company's non-regulated Dedicated IP service may be eligible for a one-time waiver of monthly charges for Enhanced Frame Relay Service.

To be eligible, customers who are contacted by the Company or who contact the Company and request this promotion must upgrade their existing Enhanced Frame Relay Service to a higher speed under a new term commitment with the same number of months or more than remain on the existing term commitment. The Company will waive the monthly recurring charges for the Frame Relay Access Line and the Permanent Virtual Circuit (PVC) for one month, with the waiver appearing on the customer's first invoice after the upgrade. The customer is only eligible for this promotion once for the same Frame Relay Access Line.

AX. Beginning June 1, 2008 and ending **December 31, 2008**, a direct mailing will be sent to all business customers with 99 lines/trunks or fewer, notifying them of their eligibility for a \$10 anniversary invoice credit. The notice will be mailed immediately prior to the anniversary of the date on which the customer established service with the Company. A bill message reminder of this offer will also appear on the customer's invoice during the customer's anniversary month. (C)

Customers who respond to this offer within 90 days after receiving the direct mailing will receive a \$10 invoice credit. The credit will appear on the customer's bill within two billing cycles after contacting the Company. When customers respond to this offer, the Company will also discuss the customers' service needs and their satisfaction with the Company.

For customers with multiple accounts, only one \$10 invoice credit is available, with such tied to the customer's oldest account.

DEC 22 2008

NPSC-Comm. Dept.

UNITED TELEPHONE COMPANY OF THE WEST - NEBRASKA
GENERAL EXCHANGE
PRICE LIST

SECTION 17

PAGE: 11

RELEASE: 2

ISSUED: October 27, 2008

EFFECTIVE: November 6, 2008

SPECIAL PROMOTIONS

AY. During the period of November 5, 2008 through February 2, 2009, new Residential Customers who are contacted by the Company or contact the Company and request this offer and who establish an account and subscribe to any Solutions Package and High Speed Internet from the Company will receive an invoice credit for up to \$25.00 each on their first and second bills. In addition, customers will receive a monthly credit of \$10 on their third through twelfth month's bill.

New Residential Customers who establish an account and subscribe to any Solutions Package and High Speed Internet plus DISH Service from the Company will receive an invoice credit for up to \$50.00 each on their first and second bills. In addition, customers will receive a monthly credit of \$20 on their third through twelfth month's bill.

The credits will be up to the amount specified, but will not exceed the customer's monthly charges (excluding long distance, taxes, surcharges, and other fees).

Eligible customers must not have had service disconnected for non-payment and must not have any past due bills for regulated services owed to the Company. This promotion does not apply to moves, changes, or additions to an existing customer's service.

If a customer discontinues service for which credit was issued prior to the end of required service period, credits issued under this promotion will not be rescinded; however, customers who discontinue service prior to the end of the minimum service or term commitment period are responsible for the termination liability charges normally applicable for that service.

AZ. **This Market Trial Promotion will be offered from November 6, 2008 through February 3, 2009. This promotion will be offered to randomly selected Residential Customers who have had service with the Company for 60 days or less, have a first month bill of \$75.00 or more, and have subscribed to any Solutions Package and/or High Speed Internet and/or DISH Service. The Company will contact these customers and inform them they will receive an invoice credit for up to \$25.00 each on their first and second bills.**

The credits will be up to the amount specified, but will not exceed the customer's monthly charges (excluding long distance, taxes, surcharges, and other fees).

Eligible customers must not have had service disconnected for non-payment and must not have any past due bills for regulated services owed to the Company. This promotion does not apply to moves, changes, or additions to an existing customer's service. This promotion may not be combined with any other promotion.

Customers who meet the qualifications for this promotion and are not contacted by the Company will be awarded the promotion benefit upon request.

(N)

(N)

UNITED TELEPHONE COMPANY OF THE WEST - NEBRASKA
GENERAL EXCHANGE
PRICE LIST

SECTION 17

PAGE: 12

RELEASE: 2

ISSUED: December 22, 2008

EFFECTIVE: January 1, 2009

SPECIAL PROMOTIONS

- BA. During the period of November 17, 2008 through February 14, 2009, new Residential Customers who are contacted by the Company or contact the Company and request this offer and who establish an account and subscribe to any Solutions Package and High Speed Internet, from the Company under a one-year commitment, will receive a credit up to \$39.90 for the 2nd, 3rd and 4th months of their one-year commitment. New Residential Customers, who establish an account and subscribe to any Solutions Package and High Speed Internet, from the Company under a two-year commitment, will receive a credit up to \$39.90 for the 2nd through 7th months of their two-year commitment.

The credits may be up to the amount specified, but will not exceed the customer's monthly charges (excluding long distance, taxes, surcharges, and other fees). This promotion does not apply to moves, changes, or additions to an existing customer's service.

If a customer discontinues service for which credit was issued prior to the end of required service period, credits issued under this promotion will not be rescinded; however, customers who discontinue service prior to the end of the minimum service or term commitment period are responsible for the termination liability charges normally applicable for that service.

Customers who meet the qualifications for this promotion and are not contacted by the Company will be awarded the promotion benefit upon request.

- BB. **Beginning January 1, 2009 and ending December 31, 2009, a direct mailing will be sent to all business customers with 99 lines/trunks or fewer, notifying them of their eligibility for a \$10 invoice credit. The notice will be mailed immediately after the anniversary of the date on which the customer established service with the Company.**

Customers who respond to this offer within 90 days after receiving the direct mailing will receive a \$10 invoice credit. The credit will appear on the customer's bill within two billing cycles after contacting the Company. When customers respond to this offer, the Company representative will review the customer's account and offer to discuss the customer's services and service needs, as well as the customer's overall satisfaction to ensure the customer is subscribed to the most appropriate services for their business needs.

For customers with multiple accounts, only one \$10 invoice credit is available, with such tied to the customer's oldest account.

(N)

(N)

RECEIVED
DEC 23 2008
U-Connect Dept

UNITED TELEPHONE COMPANY OF THE WEST - NEBRASKA
GENERAL EXCHANGE
PRICE LIST

SECTION 17
PAGE: 13
RELEASE: 3

ISSUED: August 21, 2009

EFFECTIVE: September 1, 2009

SPECIAL PROMOTIONS

- BC. During the period **September 1, 2009** through December 31, 2009, existing business customers **may** be eligible for two bill credits when they contact the Company to inform them that they have received a better priced offer for the same or comparable service(s) from a competitor, or when they contact the Company to disconnect service(s) and agree to retain their service(s) with the Company. **To be eligible**, the customer's charges for the specific service(s) for which they have received the offer must equal or exceed \$25 (excluding long distance, taxes, surcharges, and other fees) **and the customer must agree to retain the service(s) for one year after receiving the bill credits**. The credits, as specified below, may be up to this amount, but will not exceed the customer's monthly charges (excluding long distance, taxes, surcharges, and other fees) and will be reflected on the customer's bill for the first and third month bills following the customer's acceptance of this promotion. **Customers who discontinue service(s) for which the credits were issued prior to one year after issuance of the credits will be assessed all charges originally waived under the promotion.**
- (C)
(C)
(C)
(C)
(C)
(C)
(C)
(C)

<u>Monthly Charges</u>	<u>Credit Amount (up to)</u>
\$25.00 - \$ 50.00	\$ 50
\$50.01 - \$100.00	\$ 100
\$100.01 - \$250.00	\$ 250
\$250.01 - \$500.00	\$ 500
\$500.01 - \$750.00	\$ 750
Over \$750	\$1,000

- BD. During the period January 1, 2009 through December 31, 2009, business customers who are not currently subscribed to the Company's High-speed Internet or Complete Business Bundle may be eligible for a one-time waiver of the monthly recurring charge for Complete Business Bundle. To be eligible, customers who are contacted by the Company or contact the Company and request this promotion must subscribe to (1) Complete Business Bundle under a two-year term commitment and (2) High-speed Internet (1.5 Mbps or greater) under a two year term commitment.

The one-time waiver of the monthly recurring charge for Complete Business Bundle will apply for the first full month's service after the service is installed. This waiver only applies to the initial bundle ordered per location.

- BE. During the period January 1, 2009 through December 31, 2009, business customers who are not currently subscribed to the Company's High-speed Internet or MultiLine Bundle may be eligible for a one-time waiver of the monthly recurring charge for MultiLine Bundle. To be eligible, customers who are contacted by the Company or contact the Company and request this promotion must subscribe to (1) MultiLine Bundle under a two-year or three year term commitment; (2) High-speed Internet (1.5 Mbps or greater) under a two year term commitment; and 3) one of the following Embarq Communications, Inc. long distance plans: a) Business AnyTime (per account/location), b) Small Business Unlimited Solutions II (per line), or c) Block of Time for MultiLine Bundle (per account/location).

The one-time waiver of the monthly recurring charge for MultiLine Bundle will apply for the first full month's service after the service is installed. This waiver applies to all qualifying MultiLine Bundles ordered.

UNITED TELEPHONE COMPANY OF THE WEST - NEBRASKA
GENERAL EXCHANGE
PRICE LIST

SECTION 17

PAGE: 14

RELEASE: 4

ISSUED: September 29, 2009

EFFECTIVE: October 9, 2009

SPECIAL PROMOTIONS

- BF. During the period **October 9, 2009** through December 31, 2009, business customers who order any Solutions - Business Package, **MultiLine Bundle**, or **Solutions II – Business Complete Business Bundle II** may be eligible for the waiver of all service charges (excluding inside wire, construction, or CPE installation) that are otherwise applicable. To be eligible, customers who are contacted by the Company or contact the Company and request this promotion must add any Solutions Business Package, **MultiLine Bundle**, or **Solutions II – Business Complete Business Bundle II** as a new line to their account. (C)
(C)

There is no limit to the number of times a customer can receive this promotion during the promotional period.

- BG. During the period January 1, 2009 through December 31, 2009, new and existing business customers who are contacted by the Company or contact the Company and request this promotion may be eligible for a one-time bill credit when they subscribe to ISDN-PRI and/or PRI-Bundle. To be eligible, customers must order a qualifying service(s) under a new two year or greater term commitment with a resulting monthly spend of \$300 or more. Charges for all qualifying services (excluding taxes, surcharges and other fees) contribute towards the monthly spend. All nonrecurring installation and service charges normally applicable will also be waived under this promotion (excluding inside wire, construction, or CPE installation).

The credits will range from \$300 to \$2,000, but will not exceed the customer's monthly charges (excluding taxes, surcharges, and other fees) and will be reflected on the customer's bill in the next full month's billing cycle.

There is no limit to the number of qualifying services that a customer can subscribe to under this promotion.

The first full month's service for which credit will be issued will count as the first month of service under the term commitment period. If a customer discontinues service for which credit was issued prior to the end of required service period, credits issued under this promotion will not be rescinded; however, customers who discontinue service prior to the end of the term commitment period are responsible for the termination liability charges for the service(s) that are prematurely disconnected.

- BH. During the period April 1, 2009 through September 30, 2009, business customers who receive their monthly invoices in paper format may be eligible for a one-time \$10 credit. To be eligible, customers who are contacted by the Company or who contact the Company and request this promotion must agree to begin receiving their monthly invoices electronically. The \$10 credit is limited to one credit per customer account, and will be reflected on the customer's invoice for the next full month's billing cycle.

Customers who agree to convert to electronic billing under this promotion will no longer receive copies of their invoices in paper format. This credit will not be rescinded for customers who subsequently request to convert from electronic to paper invoices.

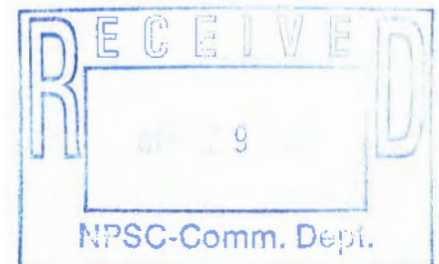

UNITED TELEPHONE COMPANY OF THE WEST - NEBRASKA
GENERAL EXCHANGE
PRICE LIST

SECTION 17

PAGE: 15

RELEASE: 4

ISSUED: July 10, 2009

EFFECTIVE: July 20, 2009

SPECIAL PROMOTIONS

- BI. From April 11, 2009 through July 4, 2009, residence customers may be eligible for a \$10 credit on their bill for three months. To be eligible, customers who are contacted by the Company or contact the Company and request this promotion must subscribe to residence flat rate service and must retain their service for at least three months.

Eligible customers must not have had service disconnected for non-payment and must not have any past due bills for regulated services owed to the Company. This promotion does not apply to moves, changes, or additions to an existing customer's service. This promotion may not be combined with any other promotion.

Customers who meet the qualifications for this promotion and are not contacted by the Company will be awarded the promotion benefit upon request.

- BJ. During the period April 23, 2009 through September 1, 2009, residence customers who are contacted by the Company or who contact the Company may be eligible to receive Caller ID with Name and/or Enhanced Call Waiting at no charge for six months. To be eligible, customers who are not already subscribed to the Caller ID with Name feature and/or the Enhanced Call Waiting feature must subscribe to one or both features. In the fifth month, the Company will contact the customer to inquire as to whether they wish to continue to receive the features at the current tariffed rate at the end of the six month period. If the customer elects not to continue, the features will be removed from the customer's account after the six month period.

Eligible customers must not have had service disconnected for non-payment and must not have any past due bills for services owed to the Company. This promotion may not be combined with any other promotion.

- BK. From July 20, 2009 through October 12, 2009, residence customers may be eligible for a \$10 credit on their bill for three months. To be eligible, customers who are contacted by the Company or contact the Company and request this promotion must subscribe to flat rate residence individual line service and must retain their service for at least three months.

Eligible customers must not have had service disconnected for non-payment and must not have any past due bills for services owed to the Company. This promotion does not apply to moves, changes, or additions to an existing customer's service. This promotion may not be combined with any other promotion.

(N)
|
(N)

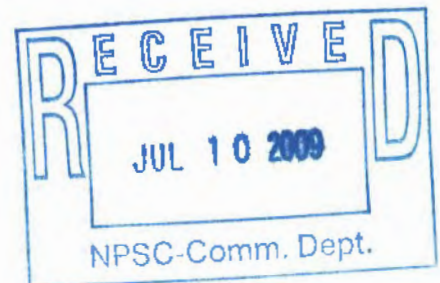

UNITED TELEPHONE COMPANY OF THE WEST - NEBRASKA
GENERAL EXCHANGE
PRICE LIST

SECTION 17

PAGE: 16

RELEASE: 2

ISSUED: March 22, 2010

EFFECTIVE: April 1, 2010

SPECIAL PROMOTIONS

- BL. During the period September 1, 2009 through **June 30, 2010**, existing business customers may be eligible for one bill credit when they contact the Company to inform them that they have received a better priced offer for the same or comparable service(s) from a competitor, or when they contact the Company to disconnect service(s) and agree to retain their service(s) with the Company. To be eligible, the customer's charges for the specific service(s) for which they have received the offer must equal or exceed \$25 (excluding long distance, taxes, surcharges, and other fees) and the customer must agree to retain the service(s) for one year after receiving the bill credit. The credit, as specified below, may be up to this amount, but will not exceed the customer's monthly charges (excluding long distance, taxes, surcharges, and other fees) and will be reflected on the customer's bill for the first month bill following the customer's acceptance of this promotion. Customers who discontinue service(s) for which the credit was issued prior to one year after issuance of the credit will be assessed all charges originally waived under the promotion. (C)

<u>Monthly Charges</u>	<u>Credit Amount (up to)</u>
\$25.00 - \$ 50.00	\$ 50
\$50.01 - \$100.00	\$ 100
\$100.01 - \$250.00	\$ 250
\$250.01 - \$500.00	\$ 500

The benefits awarded under this promotion may not be combined with the benefits of any other currently available promotion.

- BM. During the period September 1, 2009 through **June 30, 2010**, existing business customers may be eligible to receive two bill credits when they contact the Company to inform them that they have received a better priced offer for the same or comparable service(s) from a competitor, or when they contact the Company to disconnect service(s) and agree to retain their service(s) with the Company. To be eligible, the customer's charges for the specific service(s) for which they have received the offer must equal or exceed \$25 (excluding long distance, taxes, surcharges, and other fees) and the customer must agree to retain the service(s) for one year after receiving the bill credits. The credits, as specified below, may be up to this amount, but will not exceed 50% of the customer's monthly charges (excluding long distance, taxes, surcharges, and other fees) and will be reflected on the customer's first and third month bills following the customer's acceptance of this promotion. Customers who discontinue service(s) for which the credits were issued prior to one year after issuance of the credits will be assessed all charges originally waived under the promotion. (C)

<u>Monthly Charges</u>	<u>Credit Amount (up to)</u>
\$25.00 - \$ 50.00	\$ 25
\$50.01 - \$100.00	\$ 50
\$100.01 - \$250.00	\$ 125
\$250.01 - \$500.00	\$ 250

The benefits awarded under this promotion may not be combined with the benefits of any other currently available promotion.

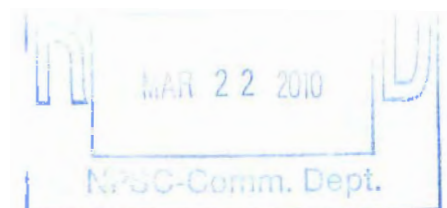

UNITED TELEPHONE COMPANY OF THE WEST - NEBRASKA d/b/a CENTURYLINK
GENERAL EXCHANGE
PRICE LIST

SECTION 17

PAGE: 17

RELEASE: 6

ISSUED: December 22, 2010

EFFECTIVE: January 1, 2011

SPECIAL PROMOTIONS

- BN. During the period October 9, 2009 through December 31, 2009, business customers who are not currently subscribed to the Company's High-speed Internet or Solutions II - Business Complete Business Bundle II may be eligible for a one-time waiver of the monthly recurring charge for Solutions II - Business Complete Business Bundle II. To be eligible, customers who are contacted by the Company or contact the Company and request this promotion must subscribe to (1) Solutions II - Business Complete Business Bundle II under a one, two, or three-year term commitment and (2) High-speed Internet (1.5 Mbps or greater) under a one, two, or three year term commitment.

The one-time waiver of the monthly recurring charge for Solutions II - Business Complete Business Bundle II will apply for the first full month's service after the service is installed. This waiver only applies to the initial bundle ordered per location.

- BO. From October 19, 2009 through **December 31, 2011**, residence customers who are contacted by the Company or who contact the Company and request this promotion may be eligible for a \$10 bill credit for twelve consecutive months. Eligible customers must not have had service disconnected for non-payment and must not have any outstanding balance owed to the Company. To be eligible, customers who are not currently subscribed to a Solutions Residence Package must subscribe to either Progressive Plan or Follow-Me Plan and must agree to retain the service for a minimum of twelve months. The initial bill credit will be reflected on the customer's first invoice issued following installation of the service. (C)

If a customer discontinues the service prior to the end of the twelve month period, no additional credits will be applied.

- BP. During the period January 2, 2010 through April 30, 2010, business customers may be eligible for a one-time waiver of the monthly recurring charge for Solutions II - Business Package Complete Business Bundle II.

To be eligible, customers who are not currently subscribed to the Company's High-speed Internet or Complete Business Bundle II who are contacted by the Company or contact the Company and request this promotion must subscribe to Complete Business Bundle II with High-speed Internet (1.5 Mbps or greater) under a two year or three year term commitment.

The one-time waiver of the monthly recurring charge for Complete Business Bundle II will apply for the first full month's service after the service is installed. This waiver only applies to the initial bundle ordered per location. This promotion may not be combined with any other promotion.

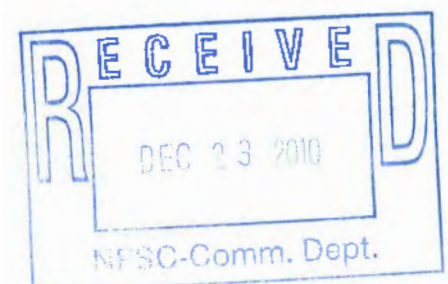

UNITED TELEPHONE COMPANY OF THE WEST - NEBRASKA d/b/a CENTURYLINK
GENERAL EXCHANGE
PRICE LIST

SECTION 17

PAGE: 18

RELEASE: 2

ISSUED: January 11, 2010

EFFECTIVE: January 21, 2010

SPECIAL PROMOTIONS

BQ. During the period January 2, 2010 through April 30, 2010, business customers may be eligible for a one-time waiver of the monthly recurring charge for MultiLine Bundle. To be eligible, customers who are not currently subscribed to the Company's High-speed Internet or MultiLine Bundle who are contacted by the Company or contact the Company and request this promotion must subscribe to all of the following services:

- (1) MultiLine Bundle under a two-year or three year term commitment;
- (2) High-speed Internet (1.5 Mbps or greater) under a two year term commitment; and
- (3) one of the following Embarq Communications, Inc. long distance plans: (a) Business AnyTime (per account/location); (b) Small Business Unlimited Solutions II (per line); (c) Block of Time for MultiLine Bundle (per account/location); or (d) Business Unlimited MultiLine (per line).

The one-time waiver of the monthly recurring charge for MultiLine Bundle will apply for the first full month's service after the service is installed. This waiver applies to all qualifying MultiLine Bundles ordered. This promotion may not be combined with any other promotion.

BR. During the period January 2, 2010 through April 30, 2010, business customers may be eligible for the waiver of all service connection charges (excluding inside wire, construction, or CPE installation) that are otherwise applicable for any Solutions II Business Package or MultiLine Bundle. To be eligible, customers who are contacted by the Company or contact the Company and request this promotion must add any Solutions II Business Package or MultiLine Bundle as a new line to their account.

There is no limit to the number of times a customer can receive this promotion during the promotional period. This promotion may not be combined with any other promotion.

BS. During the period January 21, 2010 through June 30, 2010, business customers who subscribe to Business Flat Rate, Key Trunk, and/or PBX Trunk service may be eligible for waiver of all service connection charges (excluding inside wire, construction, or CPE installation) that are otherwise applicable. To receive a waiver, customers who are contacted by the Company or who contact the Company and request this promotion must subscribe to one of the qualifying services, and commit to one year of service for the services described above. Customers subscribing to services under this promotion who discontinue service prior to meeting the one year commitment will be assessed all charges originally waived under the promotion. There is no limit to the number of times a customer can receive this promotion provided that the customer meets the required commitment level with each subsequent order.

(N)

(N)

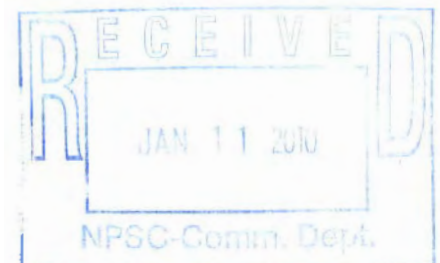

UNITED TELEPHONE COMPANY OF THE WEST - NEBRASKA d/b/a CENTURYLINK
GENERAL EXCHANGE
PRICE LIST

SECTION 17

PAGE: 19

RELEASE: 2

ISSUED: February 19, 2010

EFFECTIVE: March 1, 2010

SPECIAL PROMOTIONS

BT. During the period January 21, 2010 through June 30, 2010, business customers who subscribe to Centrex Service II may be eligible for waiver of all nonrecurring installation and service connection charges (excluding inside wire, construction, or CPE installation) that are otherwise applicable. To receive a waiver, customers who are contacted by the Company or who contact the Company and request this promotion must subscribe to one of the qualifying services, and must commit to a minimum of a one year term. Customers subscribing to services under this promotion who discontinue service within one year of installation will be assessed all charges originally waived under the promotion. There is no limit to the number of times a customer can receive this promotion provided that the customer meets the required commitment level with each subsequent order.

BU. During the period January 21, 2010 through June 30, 2010, business customers who subscribe to ISDN PRI, Frame Relay, Digilink, Translink, and/or Lightlink service may be eligible for waiver of all nonrecurring installation and service connection charges (excluding inside wire, construction, or CPE installation) that are otherwise applicable. To receive a waiver, customers who are contacted by the Company or who contact the Company and request this promotion must subscribe to one of the qualifying services, and must commit to a minimum of a one year term. Customers subscribing to services under this promotion who discontinue service within one year of installation will be assessed all charges originally waived under the promotion. There is no limit to the number of times a customer can receive this promotion provided that the customer meets the required commitment level with each subsequent order.

BV. **During the period March 1, 2010 through June 30, 2010, existing business customers may be eligible for two bill credits when they contact the Company to disconnect service(s) and instead agree to retain their service(s) with the Company. To be eligible, the customer's charges for the specific service(s) for which they were requesting disconnection must equal or exceed \$25 (excluding long distance, taxes, surcharges, and other fees) and the customer must agree to retain the service(s) for one year after receiving the bill credits.**

(N)

The customer will receive a bill credit on the first and third month's bills following the customer's acceptance of these promotion terms. The bill credits for the retained services will be equal to the monthly charges for the services that were retained after the disconnect request (excluding long distance, taxes, surcharges, and other fees), not to exceed \$1,000 per bill credit.

A customer with multiple locations is eligible for this promotion at each location for which disconnection is requested, either all at the same time or separately, with the further caveat that the maximum credit available under this offer is \$2,000 per customer, regardless of the number of service locations, accounts or billing telephone numbers the customer has in service.

Customers who discontinue service(s) for which the credits were issued prior to one year after issuance of the credits will be assessed all charges originally waived under the promotion.

This promotion may not be combined with any additional new promotions at the time the customer calls to disconnect service.

(N)

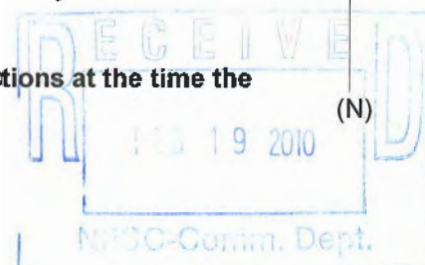

UNITED TELEPHONE COMPANY OF THE WEST - NEBRASKA d/b/a CENTURYLINK
GENERAL EXCHANGE
PRICE LIST

SECTION 17

PAGE: 20

RELEASE: 7

ISSUED: December 19, 2014

EFFECTIVE: December 29, 2014

SPECIAL PROMOTIONS

- BW. During the period April 19, 2010 through December 31, 2011, existing residence customers may be eligible for a \$5 bill credit for 12 months when they contact the Company to disconnect access line service and agree to retain service with the Company. To be eligible, the customer must agree to subscribe to Solutions - Residence Package Essential Home Phone Plan.

The initial bill credit will be reflected on the customer's first or second invoice following the customer's acceptance of this offer and will continue for 11 consecutive months thereafter. If a customer discontinues Essential Home Phone Plan prior to the end of the 12 month period, no additional credits will be applied.

This promotion may not be combined with any other promotion.

- BX. During the period April 19, 2010 through **December 31, 2015**, existing residence customers may be eligible for a \$5 bill credit for six months when they contact the Company to disconnect access line service and agree to retain service with the Company. To be eligible, a customer's account must have and maintain a B or C Credit Class rating with the Company and the customer must agree to retain flat rated one-party access line service with the Company. (C)

The initial bill credit will be reflected on the customer's first or second invoice following the customer's acceptance of this offer and will continue for five consecutive months thereafter. If a customer discontinues service being promoted prior to the end of the six month period, no additional credits will be applied.

In no event will the application of this discount be used in conjunction with any other credits to take the customer's billed amount below zero.

- BY. During the period April 19, 2010 through December 31, 2011, new residence customers who order Solutions - Residence Package, Progressive Plan, Follow Me Plan, or Essential Home Phone Plan may be eligible for the waiver of all service connection charges (excluding inside wire, construction, or CPE installation) that are otherwise applicable. To be eligible, customers who are contacted by the Company or contact the Company and request this promotion must agree to establish a new account with the Company that includes (1) Progressive Plan, Follow Me Plan, or Essential Home Phone Plan; (2) Embarq Communication, Inc. long distance plan Solutions Unlimited - Option 4; and (3) the Company's High-speed internet (at any data speed).

- BZ. During the period April 19, 2010 through September 30, 2010, the Company will waive all service connection charges (excluding charges applicable for inside wiring, construction, or CPE installation) that are otherwise applicable when business customers who are contacted by the Company or who contact the Company and request this promotion order any Solutions or Solutions II Business Package and/or MultiLine Bundle as a new line to their account. There is no limit on the number of times a customer may place orders for new lines and receive this promotional benefit during the promotional period.

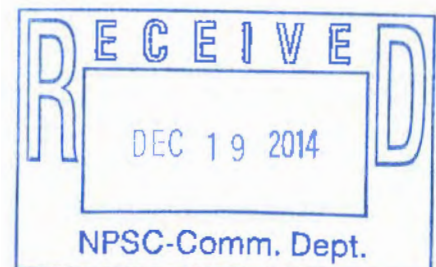

UNITED TELEPHONE COMPANY OF THE WEST - NEBRASKA d/b/a CENTURYLINK
GENERAL EXCHANGE
PRICE LIST

SECTION 17
PAGE: 21
RELEASE: 10

ISSUED: December 19, 2014

EFFECTIVE: December 29, 2014

SPECIAL PROMOTIONS

- CA. From May 1, 2010 through December 31, 2010, a direct mailing will be sent to all business customers with nine lines/trunks or fewer, notifying them of their eligibility for a \$10 invoice credit. The notice will be mailed immediately after the anniversary of the date on which the customer established service with the Company.

Customers who respond to this offer within 90 days after receiving the direct mailing will receive a \$10 invoice credit. The credit will appear on the customer's bill within two billing cycles after contacting the Company. When customers respond to this offer, the Company representative will review the customer's account and offer to discuss the customer's services and service needs, as well as the customer's overall satisfaction to ensure the customer is subscribed to the most appropriate services for their business needs.

For customers with multiple accounts, only one \$10 invoice credit is available, with such tied to the customer's oldest account.

- CB. From May 28, 2010 through **December 31, 2015**, when new residence customers who are contacted by the Company or who contact the Company and request this promotion establish a new account that includes an access line, the Company will waive the service connection charges that are otherwise applicable (excluding inside wire, construction, or CPE installation) when the customer agrees to retain service for 12 months. This waiver will only apply to the primary access line. The benefits awarded under this promotion will not be rescinded if the customer disconnects the qualifying service prior to the 12-month commitment period. (C)

- CC. From June 4, 2010 through January 31, 2011, existing business customers who are contacted by the Company or who contact the Company and request this promotion may be eligible for a credit of the monthly recurring charges for Business Individual Line Service. To be eligible, customers who have existing Business Individual Line Service must install an additional Business Individual Line and must agree to retain their service for a minimum of six months. Customers will receive three bill credits equal to the monthly recurring charge for that service. Credits will be issued for only one line when multiple lines are installed under the same order. The bill credits will be reflected on the first, second and third months following installation of the service.

Key Trunks, PBX Trunks and Rotary Hunt Service are not eligible for this promotion. Customers subscribing to services under this promotion who discontinue service within six months of installation will be assessed all charges originally credited under the promotion. There is no limit on the number of times a customer may place orders for new lines and receive this promotional benefit during the promotional period. This promotion may not be combined with any other promotional benefits.

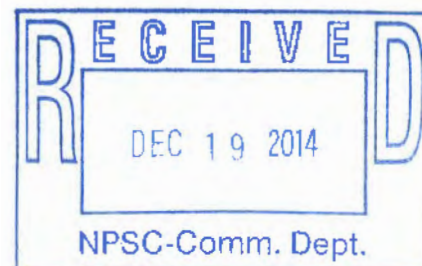

UNITED TELEPHONE COMPANY OF THE WEST - NEBRASKA d/b/a CENTURYLINK
GENERAL EXCHANGE
PRICE LIST

SECTION 17

PAGE: 22

RELEASE: 1

ISSUED: June 24, 2010

EFFECTIVE: July 6, 2010

SPECIAL PROMOTIONS

- CD. During the period July 6, 2010 through September 30, 2010, business customers who subscribe to Business Flat Rate, Key Trunk, and/or PBX Trunk service may be eligible for waiver of all service connection charges (excluding inside wire, construction, or CPE installation) that are otherwise applicable. To receive a waiver, customers who are contacted by the Company or who contact the Company and request this promotion must subscribe to one of the qualifying services, and commit to one year of service for the services described above. Customers subscribing to services under this promotion who discontinue service prior to meeting the one year commitment will be assessed all charges originally waived under the promotion. There is no limit to the number of times a customer can receive this promotion provided that the customer meets the required commitment level with each subsequent order.
- CE. During the period July 6, 2010 through September 30, 2010, business customers who subscribe to Centrex Service II may be eligible for waiver of all nonrecurring installation and service connection charges (excluding inside wire, construction, or CPE installation) that are otherwise applicable. To receive a waiver, customers who are contacted by the Company or who contact the Company and request this promotion must subscribe to one of the qualifying services, and must commit to a minimum of a one year term. Customers subscribing to services under this promotion who discontinue service within one year of installation will be assessed all charges originally waived under the promotion. There is no limit to the number of times a customer can receive this promotion provided that the customer meets the required commitment level with each subsequent order.
- CF. During the period July 6, 2010 through September 30, 2010, business customers who subscribe to ISDN PRI, Frame Relay, Digilink, Translink, and/or Lightlink service may be eligible for waiver of all nonrecurring installation and service connection charges (excluding inside wire, construction, or CPE installation) that are otherwise applicable. To receive a waiver, customers who are contacted by the Company or who contact the Company and request this promotion must subscribe to one of the qualifying services, and must commit to a minimum of a one year term. Customers subscribing to services under this promotion who discontinue service within one year of installation will be assessed all charges originally waived under the promotion. There is no limit to the number of times a customer can receive this promotion provided that the customer meets the required commitment level with each subsequent order.

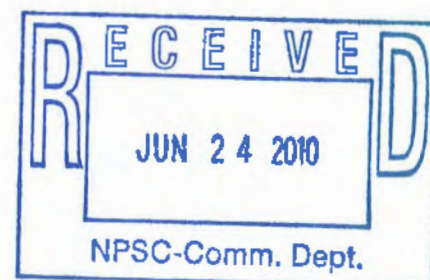

UNITED TELEPHONE COMPANY OF THE WEST - NEBRASKA d/b/a CENTURYLINK
GENERAL EXCHANGE
PRICE LIST

SECTION 17

PAGE: 23

RELEASE: 3

ISSUED: January 21, 2011

EFFECTIVE: February 1, 2011

SPECIAL PROMOTIONS

- CG. During the period July 6, 2010 through **May 31, 2011**, existing business customers may be eligible for two bill credits when they contact the Company to disconnect service(s) and instead agree to retain their service(s) with the Company. To be eligible, the customer's charges for the specific service(s) for which they were requesting disconnection must equal or exceed \$25 (excluding long distance, taxes, surcharges, and other fees) and the customer must agree to retain the service(s) for one year after receiving the bill credits. (C)

The customer will receive a bill credit on the first and third month's bills following the customer's acceptance of these promotion terms. The bill credits for the retained services will be equal to the monthly charges for the services that were retained after the disconnect request (excluding long distance, taxes, surcharges, and other fees), not to exceed \$1,000 per bill credit.

A customer with multiple locations is eligible for this promotion at each location for which disconnection is requested, either all at the same time or separately, with the further caveat that the maximum credit available under this offer is \$2,000 per customer, regardless of the number of service locations, accounts or billing telephone numbers the customer has in service.

Customers who discontinue service(s) for which the credits were issued prior to one year after issuance of the credits will be assessed all charges originally waived under the promotion.

This promotion may not be combined with any additional new promotions at the time the customer calls to disconnect service.

- CH. During the period July 6, 2010 through **May 31, 2011**, existing business customers may be eligible for one bill credit when they contact the Company to inform them that they have received a better priced offer for the same or comparable service(s) from a competitor, or when they contact the Company to disconnect service(s) and agree to retain their service(s) with the Company. (C)

To be eligible, the customer's charges for the specific service(s) for which they have received the offer must equal or exceed \$25 (excluding long distance, taxes, surcharges, and other fees) and the customer must agree to retain the service(s) for one year after receiving the bill credit.

The credit will be reflected on the customer's bill for the first month bill following the customer's acceptance of this promotion. The bill credit will be equal to the monthly charges for the services that were retained after the customer notified the company of the competitive offer or made a disconnect request (excluding long distance, taxes, surcharges, and other fees), not to exceed \$500.00 per bill credit.

A customer with multiple locations is eligible for this promotion at each location for which disconnection is requested, either all at the same time or separately, with the further caveat that the maximum credit available under this offer is \$500 per customer, regardless of the number of service locations, accounts or billing telephone numbers the customer has in service.

Customers who discontinue service(s) for which the credit was issued prior to one year after issuance of the credit will be assessed all charges originally waived under the promotion.

The benefits awarded under this promotion may not be combined with the benefits of any other currently available promotion.

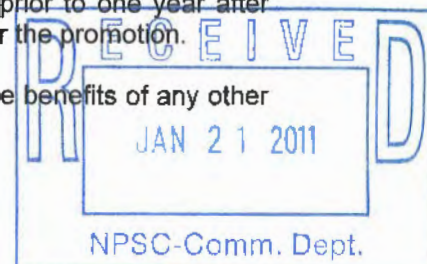

UNITED TELEPHONE COMPANY OF THE WEST - NEBRASKA d/b/a CENTURYLINK
GENERAL EXCHANGE
PRICE LIST

SECTION 17
PAGE: 24
RELEASE: 19

ISSUED: December 19, 2014

EFFECTIVE: December 29, 2014

SPECIAL PROMOTIONS

- CI. During the period July 6, 2010 through May 31, 2011, existing business customers will be eligible to receive two bill credits when they contact the Company to inform them that they have received a better priced offer for the same or comparable service(s) from a competitor, or when they contact the Company to disconnect service(s) and agree to retain their service(s) with the Company. To be eligible, the customer's charges for the specific service(s) for which they have received the offer must equal or exceed \$25 (excluding long distance, taxes, surcharges, and other fees).

The credits will be equal to 50% of the monthly charges for the services that were retained after the customer notified the company of the competitive offer or made a disconnect request (excluding long distance, taxes, surcharges, and other fees), not to exceed \$250 per bill credit. The credits will be reflected on the customer's first and third month bills following the customer's acceptance of this promotion.

A customer with multiple locations is eligible for this promotion at each location for which disconnection is requested, either all at the same time or separately, with the further caveat that the maximum credit available under this offer is \$500 per customer, regardless of the number of service locations, accounts or billing telephone numbers the customer has in service.

The benefits awarded under this promotion may not be combined with the benefits of any other currently available promotion.

- CJ. During the period August 20, 2010 through **December 31, 2015**, a 30-day satisfaction guarantee is available to residence customers who order Solutions - Residence Package, Pure Bundle with High-Speed Internet (HSI) at speeds up to and including 10 Mbps. Under this satisfaction guarantee, customers who disconnect these services within thirty days after installation will receive a credit for the monthly recurring charges that were billed through the date of disconnection when at the time of the requested disconnection they inform the Company of their subscription under this guarantee and cite their dissatisfaction with the services as the reason for the requested disconnection. When the expiration of the 30-day period falls on a weekend or legal holiday, the customer must request disconnection no later than the first business day following the weekend or legal holiday to be eligible for a credit. (C)

- CK. During the period October 15, 2010 through May 31, 2014, business customers may be eligible for a waiver of all nonrecurring charges (excluding charges applicable for inside wiring, construction, or CPE installation) that are otherwise applicable for installation of a new business line or trunk.

To be eligible, business customers who are contacted by the Company or who contact the Company and request this promotion must subscribe to High Speed Internet (1.5 Mbps or greater) with installation of a new business line or trunk. Packaged services (bundles) that include a business line or trunk are eligible for this promotion. There is no limit on the number of times a customer may place orders for new lines or trunks and receive this promotional benefit during the promotional period.

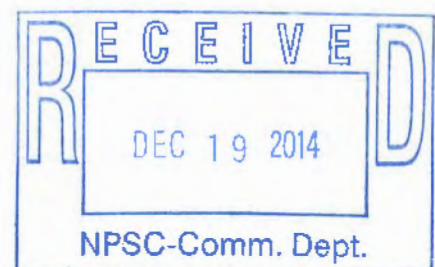

UNITED TELEPHONE COMPANY OF THE WEST d/b/a CenturyLink
NEBRASKA
GENERAL EXCHANGE PRICE LIST

SECTION 17
PAGE: 25
RELEASE: 8

ISSUED: January 27, 2015

EFFECTIVE: February 6, 2015

SPECIAL PROMOTIONS

- CL. During the period December 2, 2010 through March 31, 2011, existing business customers may be eligible for consecutive bill credits when they contact the Company to inform them that they have received a better priced offer for the same or comparable service(s) from a competitor, or when they contact the Company to disconnect service(s) and agree to retain their service(s) with the Company.

To be eligible, the customer must be subscribed to any business local exchange service and must agree to retain the service(s) for one year after receiving the bill credit. Eligible customers who are subscribed to any local exchange service will receive a \$5.00 per line bill credit for six months when they agree to retain their service(s) for a minimum of twelve additional months, or will receive a \$5.00 per line bill credit for twelve months when they agree to retain their service(s) for a minimum of twenty-four additional months. Customers may receive the credits for a maximum of ten lines during the promotional period.

Eligible customers who are subscribed to any bundled service will receive a \$10.00 bill credit per bundle for six months when they agree to retain their bundled service(s) for a minimum of twelve additional months, or will receive a \$10.00 bill credit per bundle for twelve months when they agree to retain their service(s) for a minimum of twenty-four additional months. Customers may receive the credits for a maximum of ten bundles during the promotional period.

The credits will begin appearing on customer bills the first month bill following the customer's acceptance of this promotion. The benefits awarded under this promotion may be combined with the benefits of other currently available promotions.

If the customer discontinues service(s) prior to the twelve or twenty-four month commitment period, the credits issued under this promotion will be rescinded and charges for the credit amounts will be reflected on the customer's final bill. Customers are also liable for 50% of the remaining monthly recurring charges for the service(s) disconnected.

- CM. During the period July 15, 2011 through December 31, 2015, existing **Simple Choice Unlimited** customers may be eligible for a \$10 bill credit for 12 months when they contact the Company to disconnect service and agree to retain service with the Company. To be eligible, the customer must agree to **retain** the Company's Simple Choice Unlimited for a minimum of 12 months. The initial bill credit will be reflected on the customer's first or second invoice following the customer's acceptance of this offer and will continue for 11 consecutive months thereafter. If a customer discontinues Simple Choice Unlimited prior to the end of the 12 month period, no additional credits will be applied. In no event will the application of this discount be used in conjunction with any other credits to take the customer's billed amount below zero. (T)
(T)
(T)

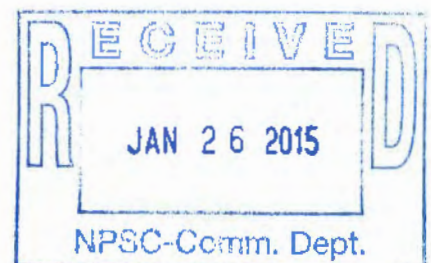

UNITED TELEPHONE COMPANY OF THE WEST d/b/a CenturyLink
NEBRASKA
GENERAL EXCHANGE PRICE LIST

SECTION 17
PAGE: 28
RELEASE: 5

ISSUED: December 20, 2013

EFFECTIVE: January 1, 2014

SPECIAL PROMOTIONS

- CN. During the period July 21, 2011 through **December 31, 2014**, new residence customers who order Simple Choice Unlimited Bundle may be eligible for the waiver of all service charges (excluding inside wire, construction, or CPE installation) that are otherwise applicable. To be eligible, customers who are contacted by the Company or contact the Company and request this promotion must agree to establish a new account with the Company that includes (1) Simple Choice Unlimited Bundle; and (2) the Company's High-speed internet (at any data speed). (C)
- CO. From February 10, 2011 through December 31, 2011, business customers with 99 lines/trunks or fewer who are not currently subscribed to the Company's High Speed Internet Service and have retained local regulated service with the Company for one year or for two years are eligible for a one-time invoice credit of up to \$10. Eligible customers who are contacted by the Company or contact the Company to request this promotion, will receive the invoice credit when they respond to this promotion during their service anniversary month (the month during which service was initially established and retained without a break in service) and discuss their account with a Company representative. The representative will review the customer's account and offer to discuss the customer's services and service needs, as well as the customer's overall satisfaction to ensure the customer is subscribed to the most appropriate services for their business needs.

Business customers who have retained service for three years, four years, or five years, are eligible to receive an upgrade to 1.544 Mbps High Speed Internet at no additional charge for three months, when they respond to the promotion during their service anniversary month. If 1.544 Mbps High Speed Internet is not available, customers with three years of continued service will receive a one-time invoice credit of up to \$25, and customers with four or five years of continued service will receive a one-time invoice credit of up to \$30.

Customers with six years or longer of continued service with the Company will receive a one-time invoice credit of up to \$35 when they respond to this promotion during their service anniversary month.

The actual amounts of the invoice credits issued will be the sum of the customer's monthly recurring charges (excluding long distance, taxes, surcharges, and other fees) or the credit amounts stated herein, whichever is less.

For customers with multiple accounts, the invoice credit is available in conjunction with the service anniversary date associated with a given account. The invoice credit will be applied to the customer's invoice within two billing cycles after the date on which customers discuss their account with a Company representative.

NE 12-PC01b

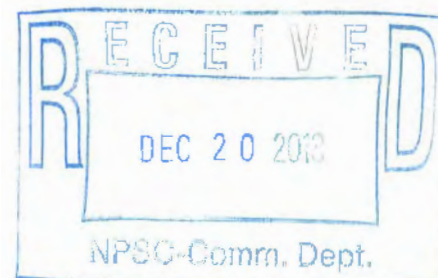

UNITED TELEPHONE COMPANY OF THE WEST d/b/a CenturyLink
NEBRASKA
GENERAL EXCHANGE PRICE LIST

SECTION 17
PAGE: 27
RELEASE: 16
EFFECTIVE: January 1, 2023

ISSUED: December 20, 2022

SPECIAL PROMOTIONS

CP. During the period October 19, 2012 through **January 31, 2024**, new business customers who subscribe to Unlimited Business Assist Advantage Plan may be eligible for a waiver of the nonrecurring charges otherwise applicable for installation of that service and a credit(s) of the monthly recurring charges. To be eligible, customers who are contacted by the Company or who contact the Company and request this promotion must not have had service disconnected with the Company for non-payment in the past, must not have any past due bills for services owed to the Company, and must have a satisfactory credit rating. (C)

Nonrecurring charges otherwise applicable for installation of a new service will be waived when eligible customers subscribe to Unlimited Business Assist Advantage Plan under a one, two or three-year term commitment. Additionally, customers subscribing under a one-year term will receive a credit for their first month's charge. Customers subscribing under a two-year term will receive a credit for the monthly recurring charge on their first and second months' invoices, and three-year term customers will receive a credit for the monthly charges on their first, second and third months' invoices. The initial bill credit will be reflected on the customer's first invoice issued following installation of the service. Credit amounts will not be applied for taxes and surcharges or for other services to which the customer subscribes.

If a customer discontinues service prior to the end of required service period, credits issued under this promotion will be rescinded. This promotion does not apply to moves, changes, or additions to an existing customer's service and may not be combined with any other promotion.

UNITED TELEPHONE COMPANY OF THE WEST d/b/a CenturyLink
NEBRASKA
GENERAL EXCHANGE PRICE LIST

SECTION 17
PAGE: 28
RELEASE: 17

ISSUED: December 20, 2022

EFFECTIVE: January 1, 2023

SPECIAL PROMOTIONS

- CQ. During the period April 29, 2014 through **January 31, 2024**, business Core Connect 2 and Core Connect 2 LITE customers may be eligible for a waiver of all nonrecurring charges (excluding charges applicable for inside wiring, construction, or CPE installation) that are otherwise applicable when they order additional Core Connect packages. (C)

To be eligible, customers who are contacted by the Company or who contact the Company and request this promotion must subscribe to an additional Core Connect package under a term discount plan. The additional line(s), up to a maximum of nine, may be at the same or different locations but must be billed under the same account. This promotional offer may not be combined with other discounts unless otherwise specified.

- CR. From June 1, 2014 through **January 31, 2024**, business customers who are contacted by the Company or who contact the Company and request this promotion may be eligible for a discount on the nonrecurring charges that are applicable for installation of a new business line or trunk. (C)

To be eligible, customers must subscribe to High Speed (HSI) Internet concurrent with installation of a new line(s) or trunk(s). Packaged services (bundles) that include a business line or trunk are eligible for this promotion. Customers will receive a discount of up to \$80 per business line or trunk installed for each location at which HSI is installed under the same order. There is no limit on the number of times a customer may place orders for new lines or trunks and receive this promotional benefit during the promotional period.

The benefits awarded under this promotion may not be combined with the benefits of other currently available promotions that waive or credit nonrecurring charges.

UNITED TELEPHONE COMPANY OF THE WEST d/b/a CenturyLink
NEBRASKA
GENERAL EXCHANGE PRICE LIST

SECTION 17
PAGE: 29
RELEASE: 1

ISSUED: January 27, 2015

EFFECTIVE: February 6, 2015

SPECIAL PROMOTIONS

CS. During the period February 6, 2015 through December 31, 2015, new and existing residence customers who are contacted by the Company or who contact the Company and request this promotion and subscribe to the Company's Pure Bundle package and the Company's non-regulated High-Speed Internet may be eligible for a \$5 bill credit for 12 or 24 months.

To be eligible, the customer must agree to subscribe to the Company's Pure Bundle and the Company's non-regulated High-Speed Internet for either a 12 or 24 month term commitment. The customer must also agree to subscribe to one of the following qualifying services for either a 12 or 24 month term commitment: 1) a Company affiliated Verizon Wireless calling plan; 2) a Company affiliated DIRECTV programming package; 3) the Company's non-regulated PRISM video service; and/or 4) the Company's non-regulated home security Smart Home protection plan.

The initial bill credit will be reflected on the customer's first or second invoice following the customer's acceptance of this offer and will continue for the remainder of the term commitment thereafter. If a customer discontinues Pure Bundle, the Company's High Speed Internet, or any of the four qualifying optional services prior to the end of the 12 or 24 month period, no additional credits will be applied.

In no event will the application of this discount be used in conjunction with any other credits to take the customer's billed amount below zero.

(N)

(N)

NE 15-PC01

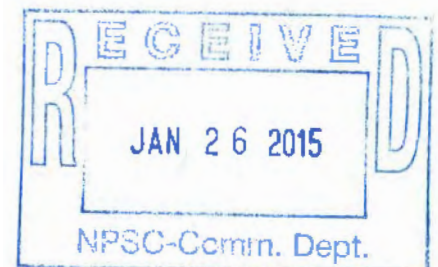

UNITED TELEPHONE COMPANY OF THE WEST d/b/a CenturyLink
NEBRASKA
GENERAL EXCHANGE PRICE LIST

SECTION 17

PAGE: 30

RELEASE: 9

ISSUED: December 17, 2020

EFFECTIVE: January 1, 2021

SPECIAL PROMOTIONS

- CT. Reserved for future use
- CU. During the period February 8, 2016 through **December 31, 2021**, when new residence customers who are contacted by the Company or who contact the Company and request this promotion establish a new account that includes an access line, the Company will waive the service connection charges that are otherwise applicable (excluding inside wire, construction, or CPE installation) when the customer agrees to retain service for 12 months. This waiver will only apply to the primary access line. The benefits awarded under this promotion will not be rescinded if the customer disconnects the qualifying service prior to the 12-month commitment period. (16-PC02) (C)
- CV. During the period February 8, 2016 through December 31, 2017, a 30-day satisfaction guarantee is available to residence customers who order Solutions - Residence Package, Pure Bundle with High-Speed Internet (HSI) at speeds up to and including 10 Mbps. Under this satisfaction guarantee, customers who disconnect these services within thirty days after installation will receive a credit for the monthly recurring charges that were billed through the date of disconnection when at the time of the requested disconnection they inform the Company of their subscription under this guarantee and cite their dissatisfaction with the services as the reason for the requested disconnection. When the expiration of the 30-day period falls on a weekend or legal holiday, the customer must request disconnection no later than the first business day following the weekend or legal holiday to be eligible for a credit. (16-PC03)

UNITED TELEPHONE COMPANY OF THE WEST d/b/a CenturyLink
NEBRASKA
GENERAL EXCHANGE PRICE LIST

SECTION 17

PAGE: 31

RELEASE: 9

ISSUED: December 17, 2020

EFFECTIVE: January 1, 2021

SPECIAL PROMOTIONS

- CW. During the period February 8, 2016 through **December 31, 2021**, existing residence customers may be eligible for a \$10 bill credit for 12 months when they contact the Company to disconnect service and agree to retain service with the Company. To be eligible, the customer must agree to extend their subscription to the Company's Simple Choice Unlimited bundle for a minimum of 12 months. The initial bill credit will be reflected on the customer's first or second invoice following the customer's acceptance of this offer and will continue for 11 consecutive months thereafter. If a customer discontinues Simple Choice Unlimited prior to the end of the 12-month period, no additional credits will be applied. In no event will the application of this discount be used in conjunction with any other credits to take the customer's billed amount below zero. (16-PC04) (C)
- CX. During the period February 8, 2016 through June 10, 2017, new and existing residence customers who are contacted by the Company or who contact the Company and request this promotion and subscribe to the Company's Pure Bundle package and the Company's non-regulated High-Speed Internet may be eligible for a \$5 bill credit for 12 or 24 months.

To be eligible, the customer must agree to subscribe to the Company's Pure Bundle and the Company's non-regulated High-Speed Internet for either a 12 or 24-month term commitment. The customer must also agree to subscribe to one of the following qualifying services for either a 12 or 24-month term commitment: 1) a Company affiliated Verizon Wireless calling plan; 2) a Company affiliated DIRECTV programming package; 3) the Company's non-regulated PRISM video service; and/or 4) the Company's non-regulated home security Smart Home protection plan.

The initial bill credit will be reflected on the customer's first or second invoice following the customer's acceptance of this offer and will continue for the remainder of the term commitment thereafter. If a customer discontinues Pure Bundle, the Company's High-Speed Internet, or any of the four qualifying optional services prior to the end of the 12 or 24 month period, no additional credits will be applied.

In no event will the application of this discount be used in conjunction with any other credits to take the customer's billed amount below zero. (15-PC01)

UNITED TELEPHONE COMPANY OF THE WEST d/b/a CenturyLink
NEBRASKA
GENERAL EXCHANGE PRICE LIST

SECTION 17
PAGE: 32
RELEASE: 4

ISSUED: December 20, 2017

EFFECTIVE: January 1, 2018

SPECIAL PROMOTIONS

- CY. During the period March 1, 2016 through April 30, 2016, business customers who are not currently subscribed to the Company's local voice, long distance or high-speed internet service may be eligible for a one-time waiver of the monthly recurring charge for Centurylink Business Bundle.

To be eligible, customers who are contacted by the Company or contact the Company and request this promotion must subscribe to CenturyLink Business Bundle under a two-year term commitment. The one-time waiver of the monthly recurring charge for CenturyLink Business Bundle will apply for the first full month's service after the service is installed. This waiver only applies to the initial bundle ordered per location.

The benefits awarded under this promotion may not be combined with the benefits of other currently available promotions that waive or credit nonrecurring charges. (16-PB01)

- CZ. During the period of July 29, 2016 through **June 10, 2017**, new and existing residence customers who are contacted by the Company or who contact the Company and request this promotion may be eligible for a \$5 bill credit for 12 months. (Z)

To be eligible, the customer must agree to subscribe to the Company's Pure Bundle (a.k.a. Pure Broadband Bundle) and the Company's non-regulated High-Speed Internet for a 12-month term commitment.

The initial bill credit will be reflected on the customer's first or second invoice following the customer's acceptance of this offer and will continue for the remainder of the term commitment thereafter. If a customer discontinues this service prior to the end of the 12-month period, no additional credits will be applied.

In no event will the application of this discount be used in conjunction with any other credits to take the customer's billed amount below zero. Additionally, the benefits awarded under this promotion may not be combined with the benefits of other currently available promotions. (16-PC05)

Received

DEC 2 2017

NPSC Comm. Dept.

UNITED TELEPHONE COMPANY OF THE WEST D/B/A CENTURYLINK
NEBRASKA
GENERAL EXCHANGE PRICE LIST

SECTION 17

PAGE: 33

RELEASE: 7

ISSUED: December 20, 2022

EFFECTIVE: January 1, 2023

SPECIAL PROMOTIONS

- DA. Beginning September 1, 2017 through **January 31, 2024**, business customers who are not currently subscribed to the Company's local voice, long distance or high-speed internet service may be eligible for a one-time waiver of the monthly recurring charge for CenturyLink Business Bundle. (C)

To be eligible, customers who are contacted by the Company or contact the Company and request this promotion must subscribe to CenturyLink Business Bundle under a two-year term commitment. The one-time waiver of the monthly recurring charge for CenturyLink Business Bundle will apply for the first full month's service after the service is installed. This waiver only applies to the initial bundle ordered per location.

The benefits awarded under this promotion may not be combined with the benefits of other currently available promotions that waive or credit nonrecurring charges. (17-PB01)

- DB. Beginning September 1, 2017 through **January 31, 2024**, business customers who are not currently subscribed to the Company's local voice or high-speed internet service may be eligible for a one-time waiver of the monthly recurring charge for Pure Bundle. (C)

To be eligible, customers who are contacted by the Company or contact the Company and request this promotion must subscribe to Pure Bundle under a two-year term commitment. The one-time waiver of the monthly recurring charge for Pure Bundle will apply for the first full month's service after the service is installed. This waiver only applies to the initial bundle ordered per location.

The benefits awarded under this promotion may not be combined with the benefits of other currently available promotions that waive or credit nonrecurring charges. (17-PB02)

UNITED TELEPHONE COMPANY OF THE WEST D/B/A CENTURYLINK
NEBRASKA
GENERAL EXCHANGE PRICE LIST

SECTION 17
PAGE: 34
RELEASE: 8

ISSUED: December 17, 2021

EFFECTIVE: January 1, 2022

SPECIAL PROMOTIONS

- DC. During the period January 1, 2018 through **December 31, 2022**, existing residence customers may be eligible for a \$5 bill credit for six months when they contact the Company to disconnect access line service and agree to retain service with the Company. To be eligible, a customer's account must have and maintain a B or C Credit Class rating with the Company and the customer must agree to retain flat rated one-party access line service with the Company. (C)

The initial bill credit will be reflected on the customer's first or second invoice following the customer's acceptance of this offer and will continue for five consecutive months thereafter. If a customer discontinues service being promoted prior to the end of the six-month period, no additional credits will be applied.

In no event will the application of this discount be used in conjunction with any other credits to take the customer's billed amount below zero. (16-PC01)

- DD. From February 20, 2021 through December 31, 2021, existing business customers who do not qualify for a term discount plan for local exchange service may be eligible for a bill credit when they agree to retain their basic local exchange service(s) for at least one year. To be eligible, customers must not have had service disconnected with the Company for non-payment in the past, must not have any past due bills for services owed to the Company, and must have a satisfactory credit rating. Customers must also be subscribed to business local exchange service or a bundle that includes local exchange service. Eligible customers who agree to retain service for one year will receive a bill credit equal to the monthly charge for the local exchange or bundled services retained. Customers who agree to retain service for two years will receive two consecutive bill credits equal to the monthly charge associated with the eligible services. Taxes and surcharges applied against the regular monthly charges will not be credited.

If a customer discontinues service prior to the end of agreed upon service period, credits issued under this promotion will be rescinded, and charges for credits issued will be reflected on the customer's final invoice. This promotion does not apply to moves, changes, or additions to an existing customer's service and may not be combined with any other promotion. (21-PB01)

UNITED TELEPHONE COMPANY OF THE WEST - NEBRASKA
GENERAL EXCHANGE
PRICE LIST

SECTION 18
PAGE: 1
RELEASE: 1

ISSUED: December 29, 1994

EFFECTIVE: January 9, 1995

RESERVED FOR FUTURE USE

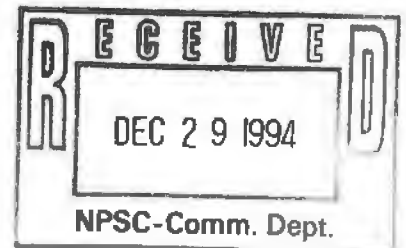

GENERAL EXCHANGE TARIFF

UNITED TELEPHONE COMPANY
OF THE WEST
NEBRASKA

Section 19
Fourth Revised Sheet 1
Cancels Third Revised Sheet 1

FCC DESIGNATED N11 SERVICE

(T)

A. 911 Service

(N)

1. GENERAL

(T)

- a) Emergency Number Service, also referred to as 911 Service, is a telephone exchange communication service whereby a Public Safety Answering Point (PSAP), designated by the customer, receives and answers telephone calls placed by dialing number 911. Emergency Number Service also includes the service provided by the lines and equipment associated with the service arrangement for the answering, transferring, and dispatching of public emergency telephone calls dialed to 911.
- b) 911 Services are offered subject to availability of facilities.
- c) The customer for Emergency Number Service may be a municipality or other state or local governmental units, or an authorized agent of one or more municipalities or other state or local governmental units to whom authority has been lawfully delegated. The customer must be legally authorized to subscribe to the service and have public safety responsibility by law to respond to telephone calls from the public for emergency police, fire fighting or other emergency services within the telephone central office areas arranged for 911 calling.
- d) Four types of 911 Service are offered: B911, C911, D911, and E911.

2. RULES AND REGULATIONS

(T)

- a) This service is limited to the use of central office telephone number 911 as the universal telephone number and only one 911 service will be provided within any government agency's locality.
- b) Emergency Number Service will be provided to only one PSAP for calling from any telephone number within a central office serving area if the Selective Routing feature is furnished. If E911 Service is furnished to a customer with the Selective Routing feature for a part of a central office serving area, and a request is received from a governmental unit with police and fire public safety responsibility for other parts of the central office serving area, service will be offered under the terms and at the rates specified in this tariff.

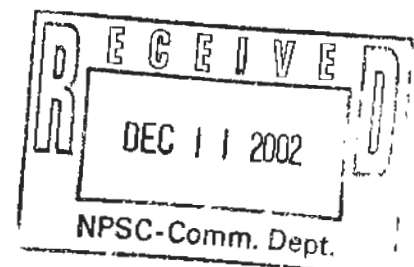

ISSUED:
December 11, 2002

BY: Warren D. Hannah
Director, Tariffs

EFFECTIVE:
December 23, 2002

GENERAL EXCHANGE TARIFF

UNITED TELEPHONE COMPANY
OF THE WEST
NEBRASKA

Section 19
Second Revised Sheet 2
Cancels First Revised Sheet 2

FCC DESIGNATED N11 SERVICE

(T)

A. 911 Service (Cont'd)

(N)

2. RULES AND REGULATIONS (Cont'd)

(T)

- c) The 911 emergency telephone number is not intended to be a total replacement of the telephone service of the various public safety agencies which may participate in the use of this number and the public safety agencies will subscribe to other telephone service as provided in II.G.5. of this section.
- d) The service is furnished to the customer only for the purpose of receiving reports of emergencies by the public.
- e) 911 exchange lines are classified as Business Exchange Service and are arranged for one-way incoming service to the appropriate PSAP.
- f) Application for 911 Service must be executed in writing by each customer. If application for service is made by an agent, the Telephone company must be provided in writing with satisfactory proof of appointment of the agent by the customer.
- g) In addition to all other terms and conditions, the following applies:
 - 1. That all 911 calls will be answered on a 24-hour, seven-day -per-week basis.
 - 2. That the customer has the responsibility for dispatching public safety police, fire and ambulance emergency service within the 911 service area, or will undertake to transfer all 911 calls received to the governmental agency with responsibility for dispatching such public safety emergency services, to the extent that such services are reasonably available.
 - 3. That the customer will also develop an appropriate method for responding to calls for nonparticipating agencies which may be directed to the 911 PSAP by calling parties.
 - 4. That the customer will subscribe to a sufficient number of interoffice facilities and 911 exchange lines, as determined by the Telephone Company to adequately handle incoming calls. In all cases, a minimum of two facilities or lines are required at

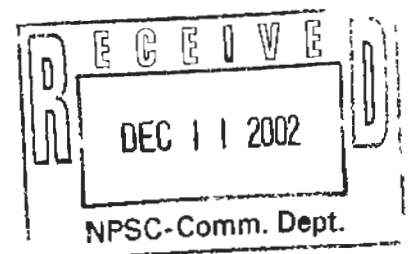

ISSUED:
December 11, 2002

BY: Warren D. Hannah
Director, Tariffs

EFFECTIVE:
December 23, 2002

GENERAL EXCHANGE TARIFF

UNITED TELEPHONE COMPANY
OF THE WEST
NEBRASKA

Section 19
Second Revised Sheet 3
Cancels First Revised Sheet 3

FCC DESIGNATED N11 SERVICE

(T)

A. 911 Service (Cont'd)

(N)

2. RULES AND REGULATIONS (Cont'd)

(T)

g) In addition to all other terms and conditions, the following applies: (Cont'd)

(T)

any point in the 911 network including the 911 exchange lines terminating at the PSAP. For 911 exchange line groups from an E911 control office to a secondary answering location used for central office transfer purposes only, the line quantity may be determined by the customer and could result in only one line being provided.

5. That the customer will subscribe for additional local exchange service at the PSAP location for administrative purposes, for placing of outgoing calls and for receiving other emergency calls including any which may be relayed by Telephone Company operators.

6. That when the Selective Routing feature is furnished the customer subscribing to E911 Service will furnish designation of the primary and secondary PSAP for receipt of police, fire, and ambulance calls by street address as provided in II.R. of this section.

h) Compatible Customer provided equipment may be used with 911 Service in accordance with the provisions of Section 23 of this tariff.

i) Temporary suspension of service at the request of the customer, either partial or complete, is not applicable to any part of 911 Service.

j) The Telephone Company's entire liability to any person for interruption or failure of any emergency numbers services shall be limited to the terms set forth in this section and other sections of this tariff.

k) Because the Telephone Company serving boundaries and political subdivision boundaries may not coincide, the customer must make arrangements to handle all calls received on its 911 service lines that originate from all telephones served by central offices to be answered by the customer, whether or not the calling telephone is situated on property within the geographical boundaries of the customer's public safety jurisdiction.

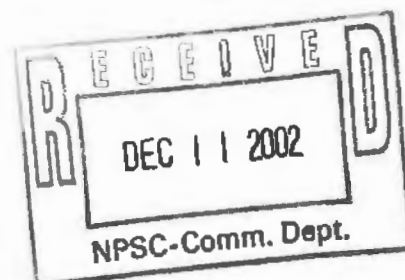

ISSUED:
December 11, 2002

BY: Warren D. Hannah
Director, Tariffs

EFFECTIVE:
December 23, 2002

GENERAL EXCHANGE TARIFF

UNITED TELEPHONE COMPANY
OF THE WEST
NEBRASKA

Section 19
Fourth Revised Sheet 4
Cancels Third Revised Sheet 4

N11 SERVICE

A. 911 Service (Cont'd)

2. RULES AND REGULATIONS (Cont'd)

l) 911 Services are furnished subject to all operating failures and interruptions including, but not limited to, equipment breakdowns, errors, defects, malfunctions and interruptions of service experienced in the regular telephone exchange system. 911 Services are furnished subject to any additional forms of service failures and service degradations resulting from the complexity of the service arrangement, program errors and failures, delays and errors in the input and processing of data used by the Data Base Management System (DBMS) associated with the E911 Service arrangement. The rates provided for this service are subject to the limitations which appear in this section and in other applicable sections of this and other tariffs. The Telephone Company does not undertake to provide a higher level of service reliability and quality than the telephone exchange service being provided in the exchange that 911 is offered.

(T)

1. 911 Service is provided solely for the benefit of the municipal subscriber; and the provision of such service shall not be interpreted, construed or regarded as being for the benefit of, or creating any Telephone Company obligation toward or any right of action on behalf of, any third person or other legal entity.
2. The Telephone Company does not undertake to answer and forward 911 calls, but furnishes the use of its facilities to enable the customer to respond to such calls with the customer's personnel on the customer's premises.
3. The rates charged for 911 Service do not contemplate and the Telephone Company does not undertake inspection or constant monitoring to discover errors, defects and malfunctions in the service. The customer shall have the responsibility of discovering all errors, defects and malfunctions, and assumes the duty of, and will make such tests as, in the judgment of the customer, are required to determine whether the system is functioning properly for its use. The customer shall promptly notify the Telephone Company in the event the system is not functioning properly.
4. The Telephone Company shall not be liable for any loss or damages arising out of errors, interruptions, defects, failures, or malfunctions of 911 Service, including any and all equipment and data processing systems associated therewith. Damages arising out of such interruptions, defects, failures, or mal-



ISSUED:
October 13, 2006

BY: Darlene N. Terry
Manager - State Tariffs

EFFECTIVE:
October 23, 2006

GENERAL EXCHANGE TARIFF

UNITED TELEPHONE COMPANY
OF THE WEST
NEBRASKA

Section 19
Fourth Revised Sheet 5
Cancels Third Revised Sheet 5

N11 SERVICE

A. 911 Service (Cont'd)

2. RULES AND REGULATIONS (Cont'd)

l) 911 Services are furnished ... (Cont'd)

functions of the system after the Telephone Company has been so notified and has had a reasonable time for repair shall in no event exceed an amount equivalent to the charges made for the service affected for the period following notice from the customer until service is restored.

- m) E911 data information, respecting the name, address and telephone number of nonpublished telephone customers, is confidential and the customer agrees to use such information only for the purpose of responding to emergency calls.
- n) The calling party dialing 911 forfeits the privacy afforded by nonpublished service to the extent that the calling party's number, address and name are furnished to the public safety answering point.
- o) Central offices that are not currently equipped to transmit ANI will not be modified to provide ANI just for 911 Services. When the Selective Routing feature is provided, in such circumstances, Default Routing and central office identification will be provided in lieu of Selective Routing and/or ANI Display.
- p) ANI may not be displayed on calls placed from two or four party lines. Central office identification is provided in lieu of ANI.
- q) A minimum of two E911 Interoffice Facilities between the end office and the E911 Control Office and two E911 Exchange Lines to each primary PSAP must be provided. On B911, C911, and D911, a minimum of two 911 exchange lines to each PSAP is required.
- r) When the Selective Routing feature is provided (E911), the customer is responsible for identifying the unique combinations of police, fire and ambulance, or any other appropriate agencies jurisdiction in the E911 serving area. An Emergency Service Number (ESN) will be provided for each unique combination by the Telephone Company. The customer will associate these ESNs with street address ranges in the E911 serving area. These ESNs will be carried in the Data Base Management System (DBMS) to route E911 calls to the primary and secondary

(T)
(T)

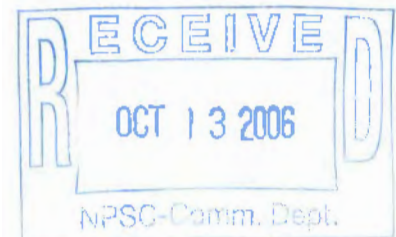

ISSUED:
October 13, 2006

BY: Darlene N. Terry
Manager - State Tariffs

EFFECTIVE:
October 23, 2006

GENERAL EXCHANGE TARIFF

UNITED TELEPHONE COMPANY
OF THE WEST
NEBRASKA

Section 19
Second Revised Sheet 6
Cancels First Revised Sheet 6

FCC DESIGNATED N11 SERVICE

A. 911 Service (Cont'd)

2. RULES AND REGULATIONS (Cont'd)

r) When the Selective Routing feature is provided (E911)... (Cont'd)

PSAPs with responsibility to handle the emergency telephone calls originating for each telephone in the E911 serving area.

The customer's responsibility for providing this information is as follows:

1. The customer will provide street address and PSAP routing information for each central office area included in the E911 service area prior to establishment of service.
2. Initial and subsequent ESN assignments by street name, address range and area or other mutually agreed upon routing criteria, shall be furnished by the customer to the Telephone Company on forms supplied by the Telephone Company for that purpose at a mutually agreed upon time prior to the effective date of the service.
3. After establishment of service, it is the customer's responsibility to continue to verify the accuracy of the routing information contained in the master address file and to advise the Telephone Company of any changes that need to be made in the routing information by reason of changes in street names, establishment of new streets, changes in address numbers used on existing streets, closing and abandonment of streets, changes in police, fire, ambulance or other appropriate agencies' jurisdiction over any address, annexations and other changes in municipal and county boundaries, incorporation of new cities and any other matters that will affect the routing of E911 calls to the proper PSAP.
 - a) Changes, deletions and additions which the customer desires to have made in the master address file should be submitted on an "as occurred" basis.
 - b) The Telephone Company will furnish a written copy to the customer for verification showing each change, deletion and addition to master address file.
4. The Telephone Company will provide at the request of the customer, a complete written copy of the master address file for the purpose of the customer verifying the accuracy of the police, fire and ambulance PSAP routing designations.

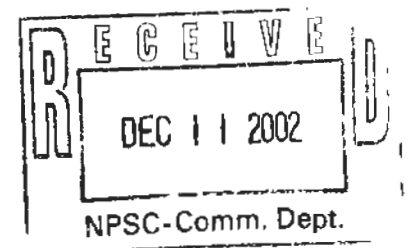

ISSUED:
December 11, 2002

BY: Warren D. Hannah
Director, Tariffs

EFFECTIVE:
December 23, 2002

GENERAL EXCHANGE TARIFF

UNITED TELEPHONE COMPANY
OF THE WEST
NEBRASKA

Section 19
Second Revised Sheet 7
Cancels First Revised Sheet 7

FCC DESIGNATED N11 SERVICE

(T)

A. 911 Service (Cont'd)

(N)

2. RULES AND REGULATIONS (Cont'd)

(T)

- s) Cancellation of the service in whole or part by the customer prior to establishment thereof will require payment of an amount equal to the cost of engineering, manufacturers' billings resulting from equipment orders, installation, assembly, labor, cost of removal and any other costs incurred up to the time of cancellation resulting from the customer's order for service, but not to exceed the total nonrecurring charges.
- t) Where not otherwise precluded by law, each customer agrees to release, indemnify, defend and hold harmless the Company from any and all loss, claims, demands, suits or other action, or any liability whatsoever, whether suffered, made, instituted or asserted by the customer or by any other party or person, for any personal injury to or death of any person or persons, or for any loss, damage or destruction of any property, whether owned by the customer or others.
- u) Where not otherwise precluded by law, the customer also agrees to release, indemnify and hold harmless the Company for any infringement or invasion of the right of privacy of any person or persons caused or claimed to have been caused, directly or indirectly, by the installation, operation, failure to operate, maintenance, removal presence, condition, occasion or use of 911 Service features and the equipment associated therewith, or by any services furnished by the Company in connection therewith, including but not limited to, the identification of the telephone used by the party or parties accessing 911 Service hereunder, and which arise out of the negligence or other wrongful act of the Company, the customer, its user, agencies or municipalities, or the employees or agents of any one of them.

3. EXPLANATION OF TERMS

(T)

Additional E911 Service Exchange Line:

An additional line terminating at a PSAP that may be ordered by the customer as an optional feature.

Alternate Routing (AR):

This feature is provided to allow 911 calls to be routed to a designated alternate location if (1) all E911 exchange lines to the primary PSAP are busy, or (2) the primary PSAP closes down for a period (night service).

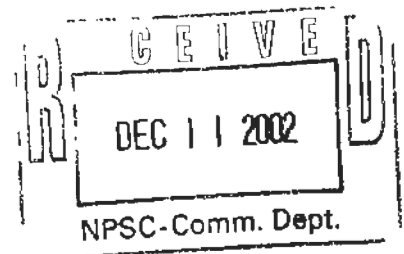

GENERAL EXCHANGE TARIFF

UNITED TELEPHONE COMPANY
OF THE WEST
NEBRASKA

Section 19
Fourth Revised Sheet 8
Cancels Third Revised Sheet 8

N11 SERVICE

A. 911 Service (Cont'd)

3. EXPLANATION OF TERMS (Cont'd)

Automatic Number Identification (ANI):

Telephone number associated with the access line from which a call originates.

(T)

Automatic Location Identification (ALI)

The automatic display at the PSAP of the caller's telephone number, the address/location of the telephone and supplementary emergency services information.

(N)

(N)

B911:

A service that provides for routing all 911 calls originated from telephones with given central office prefix codes to a single PSAP.

Called Party Hold (CPH):

A feature of C911 Service that enables a PSAP attendant to retain control of an incoming 911 call connection, even if the calling party hangs up.

C911:

A service that provides the B911 feature as well as Called Party Hold, Switchhook Status, Forced Disconnect, Idle Tone Application and Emergency Ringback.

Data Base Management System (DBMS):

A System of manual procedures and computer programs used to create, store, and update the data required to provide Selective Routing and/or Automatic Location Identification for E9-1-1 systems. DBMS also provides for an initial information load for the data base stored in customer provided equipment, as well as the equipment of other 911 Service Providers and for periodic updates to this information.

(T)

(T)

Default Routing (DR):

This feature is activated when an incoming 911 call cannot be selectively routed due to an ANI failure, garbled digits or other causes which may prevent selective routing. Such incoming calls to the E911 Control Office are routed to a default PSAP. Each incoming 911 facility group to the Control Office is assigned to a designated default PSAP.

Display and Transfer Unit:

A selector console and associated common equipment that displays ANI numbers at the PSAP attendant position and is used by the attendant to activate Fixed and/or Selective Transfer functions.

D911:

A service which provides the B911 feature plus Automatic number Identification (ANI) and is primarily for use in single wire center exchanges.

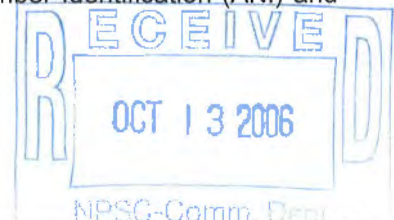

ISSUED:
October 13, 2006

BY: Darlene N. Terry
Manager - State Tariffs

EFFECTIVE:
October 23, 2006

GENERAL EXCHANGE TARIFF

UNITED TELEPHONE COMPANY
OF THE WEST
NEBRASKA

Section 19
Second Revised Sheet 9
Cancels First Revised Sheet 9

FCC DESIGNATED N11 SERVICE

(T)

A. 911 Service (Cont'd)

(N)

3. EXPLANATION OF TERMS (Cont'd)

(T)

End Office:

This is the Central Office(s) in the 911 System from where the 911 calls originate.

E911:

An expanded service that provides features such as Selective Routing of 911 calls to a specific PSAP selected from among those within the 911 Service Area. E911 has other standard and optional features which may or may not be available with B911, C911 or D911.

Expanded 911 (E911) Control Office:

The Control Office provides tandem switching capability for E911 calls. It controls switching of ANI and SR information to the PSAP.

Fixed Transfer:

This feature enables a PSAP attendant to transfer incoming 911 calls to secondary PSAPs by use of a single button on the Display and Transfer Unit. The PSAP equipment automatically flashes and sends out the Speed Calling code associated with the desired agency. ANI will also be transferred with the call to a secondary PSAP that is equipped to receive and display ANI data. This is done by using the Central Office Call Transfer feature of the E911 Control Office. This feature is associated with the E911 trunk unit and may not be available from all central offices. This is an optional feature of E911 Service.

Forced Disconnect:

This feature, a function of the E911 Central Office trunk circuit enables the PSAP attendant to release a 911 connection even though the 911 calling party has not hung up. This feature prevents the jamming of the E911 exchange lines. This is a standard feature of the C911 and E911 Service.

Idle Tone Application:

This feature allows the PSAP attendant to distinguish between calls that have been abandoned before they are answered and calls where the calling party is unable to speak for some reason. If the caller abandoned the line before the PSAP attendant answered, a distinct tone is heard by the attendant. If the caller is still on the line but unable to speak, no tone will be heard. This feature is available with C911 and E911 Service.

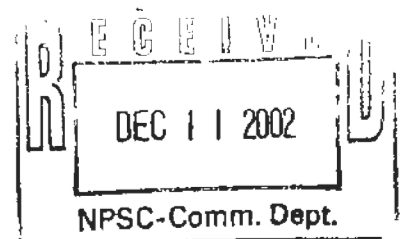

ISSUED:
December 11, 2002

BY: Warren D. Hannah
Director, Tariffs

EFFECTIVE:
December 23, 2002

GENERAL EXCHANGE TARIFF

UNITED TELEPHONE COMPANY
OF THE WEST
NEBRASKA

Section 19
Fourth Revised Sheet 10
Cancels Third Revised Sheet 10

N11 SERVICE

A. 911 Service (Cont'd)

3. EXPLANATION OF TERMS (Cont'd)

Public Safety Answering Point (PSAP):

A PSAP is an answering location for 911 calls originating in a given area. A PSAP may be designated as primary or secondary, which refers to the order in which calls are directed for answering. Primary PSAP's respond first, Secondary PSAP's receive calls on a transfer basis only. PSAP's are public service agencies such as police, fire, emergency medical, etc., or a common bureau serving a group of such entities.

Selective Routing (SR):

This feature routes a 911 call from a central office to the designated PSAP. This is an optional feature of the E911 Service.

Selective Transfer:

This feature transfers an incoming call to another agency by depressing a single button (e.g., "Fire" on the Display and Transfer Unit). This type of transfer is only available when the SR feature is provided. This is an optional feature of the E911 Service and may not be available from all central offices.

Service Area:

The geographical area in which the customer will respond to all 911 calls and dispatch appropriate emergency assistance.

Service Provider

An entity providing one or more of the following 9-1-1 elements: network, CPE, or data base service.

(N)
:
(N)

Serving Central Office:

This is the Central Office(s) in which a PSAP, either a primary or secondary, is located.

Switchhook Status:

A feature that provides the PSAP attendant with visual indication of the calling party's switchhook status (on or off hook).

4. RATES

Rates for 911 Service shall be determined on a case by case basis as provided for under Sheets 5 and 6 of the "General Rules and Regulations Applying to Telephone Service" section of this tariff. Other charges outlined in the Local and General Exchange Tariffs may also apply.



ISSUED:
October 13, 2006

BY: Darlene N. Terry
Manager - State Tariffs

EFFECTIVE:
October 23, 2006

GENERAL EXCHANGE TARIFF

UNITED TELEPHONE COMPANY
OF THE WEST
NEBRASKA

Section 19
Second Revised Sheet 10.1
Cancels First Revised Sheet 10.1

N11 SERVICE

A. 911 Service (Cont'd)

5. WIRELESS E911 PHASE 2

a) Description of Service

Wireless E911 Phase 2 is only available in combination with E911 as specified in this section of the tariff and is subject to the regulations specified herein.

In accordance with the FCC's Report and Order 94-102, Wireless E911 Phase 2 provides PSAPs with the wireless E911 caller's location and callback number (CBN) information, as specified by the FCC. The FCC has adopted specific handset-based and network-based location accuracy and reliability solutions standards for the Wireless Service Providers (WSPs).

b) General Regulations

1. The Telephone Company is not responsible for the location determination technology, the accuracy of the location determination technology, or the investigation or maintenance of said technologies. Only the data required and specified by the FCC in its Report and Order 94-102 will be delivered by the Telephone Company to the PSAP. This required data includes the cell site or sector location, the callback number, and the latitude/longitude of the caller. Each customer agrees that delivery, or lack of delivery, of additional data elements which may be provided by the WSP will not be the responsibility of the Telephone Company and the Telephone Company assumes no responsibility or liability for such information.

2. PSAPs must have all required elements of Wireless E911 Phase 1, utilizing p-ANI routing and cell site/sector location based information, in place before implementing Phase 2. This is necessary to accommodate loading of the respective p-ANIs also known as Emergency Service Routing Key/Emergency Service Routing Digit into the Telephone Company's **Data Base Management System**. In addition, the following requirements must be met for Phase 2 implementation:

a) PSAPs must order both the Telephone Company's Extended ALI Display Format and the ALI Database Upgrade for Wireless Phase 2 to accommodate the x/y data provided by Wireless E911 Phase 2 Service. See rates in Section 19.A.5.f. following.

b) WSPs must have Position Determining Entity (PDE) and a Mobile Position Center (MPC)/Gateway Mobile Location Center (GMLC) in their network.

c) WSPs or their designated database provider must have obtained an interface to the Telephone Company's ALI database that complies with the Telephone Company's existing operating standard. This interface will be used by the WSP to provide the Phase 2 data.

(T)

ISSUED:
October 13, 2006

BY: Darlene N. Terry
Manager - State Tariffs

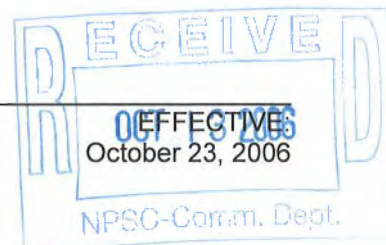

GENERAL EXCHANGE TARIFF

UNITED TELEPHONE COMPANY
OF THE WEST d/b/a CenturyLink
NEBRASKA

Section 19
Third Revised Sheet 10.5
Cancels Second Revised Sheet 10.5

N11 SERVICE

A. 911 Service (Cont'd)

5. WIRELESS E911 PHASE 2 (Cont'd)

f) Rates and Charges

	<u>Nonrecurring Charge</u>	<u>Monthly Rate</u>	<u>SAE Code</u>	
1. Enhanced MF signaling, per PSAP	\$0.00	\$0.00	-	
2. Extended ALI Display Format and ALI Database Upgrade for Wireless Phase 2, per 100 Wireless Subscriber Lines ⁽¹⁾	\$0.00	\$2.30	AEMDATA (WLS)	(C) (I)

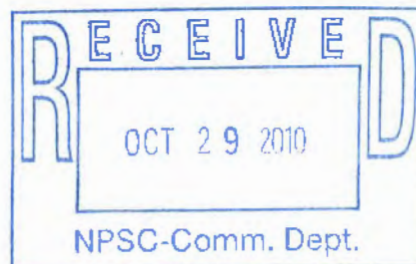

⁽¹⁾ The number of wireless subscriber lines will be based on the counts reported to the Commission in wireless quarterly reports.

GENERAL EXCHANGE TARIFF

UNITED TELEPHONE COMPANY
OF THE WEST
NEBRASKA

Section 19
Original Sheet 10.6

N11 SERVICES

A. 911 Service (Cont'd)

6. Private Switch Database Service

a) Description of Service

1. Private Switch Database Service is available to companies that use a Private Branch Exchange (PBX) or Centrex to manage their individual telephones and want to provide specific location information for each of these telephones to the Public Safety Answering Point (PSAP) responsible for responding to an emergency.
2. Private Switch Database Service allows a customer with a multi-line private switch to facilitate reception of either (1) Automatic Number Identification (ANI) or (2) a combination of ANI and Automatic Location Identification (ALI) information by a PSAP for emergency "9-1-1" calls originating from the location served by the customer's multi-line private switch. A private switch is customer premises equipment (CPE) at the end user customer's location.

b) General Regulations

1. The customer is responsible for validating address information through Master Street Access Guide (MSAG) and for coordinating with the Company to provide the National Emergency Number Association (NENA) standard format of telephone numbers and address data. The Company will allow the customer to update records no more frequently than on a daily basis. The data may originate from the customer's private switch, when technically feasible, or from a manually created list.
2. The Company will:
 - (a) Be responsible for uploading a NENA formatted data file to its ALI database;
 - (b) Hold the information in confidence and protect it in accordance with state and federal rules applicable to emergency 911 services; and
 - (c) Use the information only in connection with providing emergency services to PSAPs.
3. The Company may immediately terminate a customer's use of Private Switch Database Service if, in the Company's sole judgment, the customer falsifies the information provided or fails to comply with any other provisions of this tariff.

ISSUED:
October 29, 2007

BY: Darlene Terry
Manager, Tariffs

EFFECTIVE:
November 8, 2007

GENERAL EXCHANGE TARIFF

UNITED TELEPHONE COMPANY
OF THE WEST
NEBRASKA

Section 19
Original Sheet 10.7

N11 SERVICES

A. 911 Service (Cont'd)

6. Private Switch Database Service (Cont'd)

b) General Regulations (Cont'd)

4. The Company will only provide Private Switch Database Service where the Company is the primary 911 database provider for the PSAP serving the customer's location.
5. The Company will provide a software package that will allow the customer to load the database information in the appropriate NENA format for transmission to the Company's data center.
6. The Company will charge the private switch customer a monthly recurring charge for maintenance of the data in the national ALI database for delivery upon a 911 call to the PSAP.

c) Limitations

1. The Company offers no warranty or representation with respect to the accuracy or completeness of the Private Switch Database Service. The Company relies on its customers for all private switch information placed in the Company's database management system.
2. The Company does not warrant or represent that its database management system will be compatible with every type of private switch equipment. Customers who wish to provide automated updates to the Company's database management system are responsible for acquiring their own private switch equipment and for testing the compatibility of that equipment with the Company's database management system.

d) Obligations of the Customer

1. When implementing Private Switch Database Service, the customer must contact the Telephone Company's E-911 representative to negotiate trunking, hardware and software requirements associated with the Private Switch Database Service.
2. The customer will be responsible for loading address information into the Private Switch Database Service software package and transmitting that information to the Company.

ISSUED:
October 29, 2007

BY: Darlene Terry
Manager, Tariffs

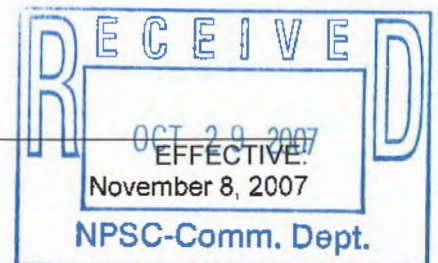

GENERAL EXCHANGE TARIFF

UNITED TELEPHONE COMPANY
OF THE WEST
NEBRASKA

Section 19
Original Sheet 10.8

N11 SERVICES

A. 911 Service (Cont'd)

6. Private Switch Database Service (Cont'd)

e) Rates and Charges

1. Private Switch Database Service rates

		<u>Nonrecurring Charge</u>
(a)	Installation	
	(1) Initial Installation	\$900.00
	(2) Subsequent addition of Station Records	0.00
		<u>Monthly Recurring Charge</u>
(b)	Monthly Rate ⁽¹⁾	
	(1) Up to 1000, per 1000 Station Records	\$100.00
	(2) 1001 - 4000, per 1000 Station Records	70.00
	(3) Over 4000, per 1000 Station Records	60.00

2. Separate charges, not specified in this section of the tariff, are applicable for network connectivity from the customer's private switch to the Company's central office facilities.
3. Each Private Switch Database Service customer's Installation Charge and monthly rate is calculated at the time Private Switch Database Service is established and is based on the number of station records in service for the customer. The total number of station records are audited annually by the Telephone Company and applied to the account.

⁽¹⁾ The monthly rate is calculated based on the total number of station records submitted by the customer at installation or at the time of the annual audit. For example, 900 station records = \$100 MRC; 3900 station records = \$70 X 4 = \$280 MRC; 4500 station records = \$60 X 5 = \$300 MRC.

ISSUED:
October 29, 2007

BY: Darlene Terry
Manager, Tariffs

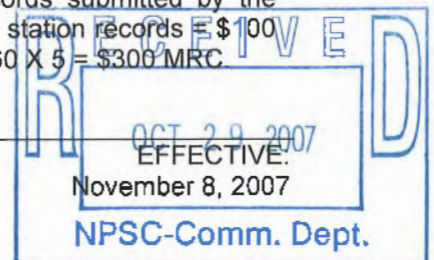

GENERAL EXCHANGE TARIFF

UNITED TELEPHONE COMPANY
OF THE WEST
NEBRASKA

Section 19
Original Sheet 10.9

N11 SERVICES

A. 911 Service (Cont'd)

7. Reverse Notification Telephone Number Database Service

a) Description of Service

1. The Company offers Reverse Notification Telephone Number Database Service (Reverse Database Service) to support the ability of Public Safety Answering Points (PSAPs) to make broadcast notification calls to areas under their jurisdiction in the event of emergencies.

b) General Regulations

1. Reverse Database Service is offered solely for the purpose of permitting PSAPs to make broadcast notifications to particular geographic areas and associated local telephone numbers in the event of emergencies. PSAPs ordering Reverse Database Service must provide the Company with written certification of their authority to make public emergency notifications.
2. PSAPs may not use Reverse Database Service information in connection with E911 Emergency Reporting Services.
3. PSAPs subscribing to Reverse Database Service will receive CD-ROM downloads of information from the Company's Automatic Location Indicator (ALI) database. The Company will provide ten-digit telephone numbers and associated addresses, to the extent that information is present in the Company's ALI database.
4. Reverse Database Service will include ALI information obtained by the Company from other local exchange carriers serving a PSAP's jurisdiction, when there are multiple local exchange carriers in a PSAP's jurisdiction. Reverse Database Service will include ALI information obtained from customers who operate private switches and have requested that carriers maintain appropriate information in the carrier's ALI database.
5. The Company will provide Reverse Database Service only for the jurisdictional area where a PSAP is authorized to provide emergency services. PSAPs will not be able to obtain foreign listings, foreign exchange cross-listings, foreign central office subscriptions and multiple listings through Reverse Database Service.

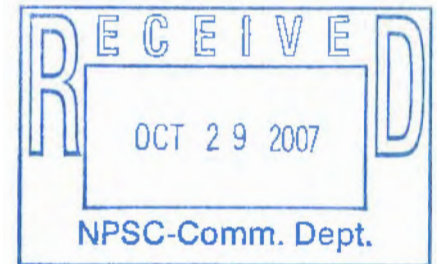

ISSUED:
October 29, 2007

BY: Darlene Terry
Manager, Tariffs

EFFECTIVE:
November 8, 2007

GENERAL EXCHANGE TARIFF

UNITED TELEPHONE COMPANY
OF THE WEST
NEBRASKA

Section 19
Original Sheet 10.10

N11 SERVICES

A. 911 Service (Cont'd)

7. Reverse Notification Telephone Number Database Service (Cont'd)

a) General Regulations (Cont'd)

6. The Company considers all information provided to a PSAP under Reverse Database Service to be confidential and proprietary. Information received through Reverse Database Service may contain the addresses and telephone numbers of individuals whose listings are not published in directories and/or are not listed in directory assistance databases. The PSAP must:
 - (a) Hold all Reverse Database Service information in confidence and protect it in accordance with the security regulations by which it protects its own proprietary or confidential information;
 - (b) Restrict disclosure of the information solely to those PSAP employees and/or agents with a need to know and not disclose or resell such information to any other parties;
 - (c) Use the information only when delivering broadcast notifications of emergencies; and
 - (d) Notify the Company immediately of any confirmed or suspected misuse of Reverse Database Service information.
7. The PSAP represents and warrants that it will use information received through Reverse Database Service only in emergency situations. A PSAP may not access, use, import, export, copy, print, distribute or release information for any purpose other than what is necessary to make outbound telephone emergency notifications.
8. The Company may immediately terminate a PSAP's use of Reverse Database Service and demand the return of all Reverse Database Service information furnished to the PSAP if, in the Company's judgment, the PSAP misuses the information provided or fails to comply with any other provision of this tariff.
9. A PSAP's modification, merger or enhancement of information received through the Reverse Database Service will not relieve the PSAP from any provision of this tariff.

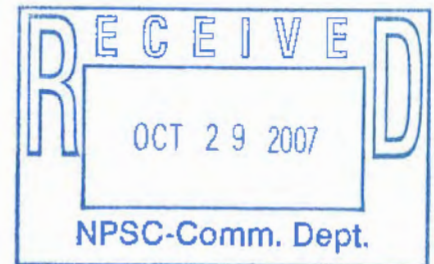

ISSUED:
October 29, 2007

BY: Darlene Terry
Manager, Tariffs

EFFECTIVE:
November 8, 2007

GENERAL EXCHANGE TARIFF

UNITED TELEPHONE COMPANY
OF THE WEST
NEBRASKA

Section 19
Original Sheet 10.11

N11 SERVICES

A. 911 Service (Cont'd)

7. Reverse Notification Telephone Number Database Service (Cont'd)

c) Limitations

1. The Company offers no warranty or representation with respect to the accuracy or completeness of the Reverse Database Service. The Company may rely on other local exchange carriers or private switch customers for certain information used in the Reverse Database Service.
2. The Company does not warrant or represent that the Reverse Database Service will be compatible with every type of reverse notification equipment. PSAPs are responsible for acquiring their own broadcast notification equipment and for testing the compatibility of that equipment with the Reverse Database Service.
3. By offering Reverse Database Service, the Company makes no warranties or representations for the operation of a customer's broadcast notification equipment or for the availability or performance of any telephone network facilities, including the Company's facilities, during a broadcast notification.

d) Liability of the Company

1. By subscribing to Reverse Database Service, a PSAP agrees to hold harmless and indemnify the Company, along with its employees, directors, officers, agents and subcontractors, from and against all claims or suits arising out of or resulting from the provision of Reverse Database Service, specifically including, but not limited to, all claims or suits resulting from or allegedly resulting from errors or omissions in the file or the use of such information by the PSAP or its agents.
2. To the extent that the PSAP claims sovereign immunity or other statutory limitations against third party claims, the PSAP will extend that same protection to the Company in connection with the PSAP's use of the Reverse Database Service.

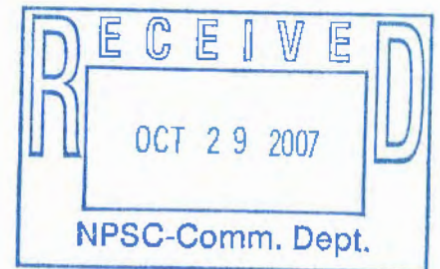

ISSUED:
October 29, 2007

BY: Darlene Terry
Manager, Tariffs

EFFECTIVE:
November 8, 2007

GENERAL EXCHANGE TARIFF

UNITED TELEPHONE COMPANY
OF THE WEST
NEBRASKA

Section 19
Original Sheet 10.12

N11 SERVICES

A. 911 Service (Cont'd)

7. Reverse Notification Telephone Number Database Service (Cont'd)

e) Limitations

1. PSAPs can purchase Reverse Database Service in the following formats:
 - (a) One-time update – a nonrecurring charge is applicable per occasion.
 - (b) Monthly update – A recurring charge per month is applicable. The service is only offered on a 12 month minimum basis. If service is terminated prior to the 12 months, the monthly charge is applicable for the full 12 months.

	<u>Nonrecurring Charge</u>	<u>Monthly Rate</u>
2. Reverse Database Service,		
(a) One-time update (CD-ROM)	\$500.00	\$ 0.00
(b) Monthly update (CD-ROM) 12 Month Term	0.00	125.00

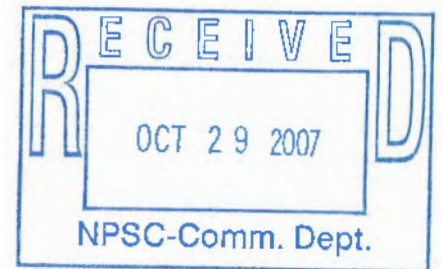

ISSUED:
October 29, 2007

BY: Darlene Terry
Manager, Tariffs

EFFECTIVE:
November 8, 2007

GENERAL EXCHANGE TARIFF

UNITED TELEPHONE COMPANY
OF THE WEST
NEBRASKA

Section 19
Original Sheet 11

FCC DESIGNATED N11 SERVICE

B. 711 Service For Telecommunications Relay Services (TRS)

1. General

- a) 711 Dialing Code ("711") is a three digit local dialing arrangement for telephone voice transmission access to all certified Telecommunications Relay Services entities as a toll free call. Pursuant to Order 00-257, issued by the Federal Communications Commissions (FCC) in CC Docket 92-105, the FCC assigned 711 dialing code for nationwide access to Telecommunications Relay Services (TRS) entities, to be implemented not later than October 1, 2001.
- b) 711 is available from the Company within the Company's service area only. To provide access to 711 to end users in another company service area or to a Competitive Local Exchange Carrier (CLECs) end users within the local calling area, the TRS entity must make appropriate arrangements with the other company or CLEC serving that territory. The TRS entity should work separately with competing local providers to ascertain that its end user customers will be able to reach relay services provided by dialing 711.
- c) This service is subject to the availability of the 711 dialing code.
- d) 711 can be delivered via regular exchange access lines (by individual business lines, PBX trunks, etc.).
- e) Limitations and use of service are as stated in the General Rules and Regulations of this Tariff.
- f) Directory Listings may be provided for 711 at rates and regulations as specified in Section 4 of this Tariff.
- g) Access to 711 is not available to the following classes of service:
 - Hotel/Motel/Hospital Service (toll call only)
 - 1+
 - 0+, 0- (Credit Card, Third-Party Billing, Collect Calls)
 - Inmate Service
 - 101XXXX
 - Cellular - Type 2AIn addition, operator assisted calls to 711 will not be completed

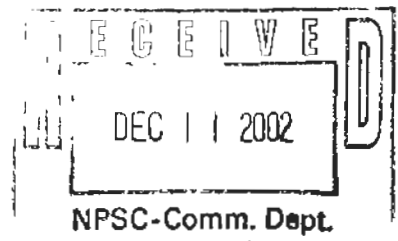

ISSUED:
December 11, 2002

BY: Warren D. Hannah
Director, Tariffs

EFFECTIVE:
December 23, 2002

GENERAL EXCHANGE TARIFF

UNITED TELEPHONE COMPANY
OF THE WEST
NEBRASKA

Section 19
Original Sheet 12

FCC DESIGNATED N11 SERVICE

B. 711 Service For Telecommunications Relay Services (TRS) (Cont'd)

2. Obligations of the TRS Entity

- a) The TRS entity must, prior to provisioning of the service, sign a written acknowledgement of possible recall of the 711 dialing code by the FCC and an agreement to return the code upon receipt of 6 months written notice of such a recall from the Company or regulating entity and abide by all terms and conditions which may be identified by the FCC in CC Docket 92-105 regarding the use and return of the 711 dialing code. If a recall is effected, the Company will work with the TRS entity affected by such recall to transfer their service arrangements, to a 7 or 10-digit dialing arrangement within the 6-month notice period. The TRS entity will be required to migrate to any access arrangement the telecommunications relay services subsequently agreed to by the industry and approved by the FCC. The TRS entity will be charged the appropriate tariff rates for the establishment of the new access arrangement.
 - b) The TRS entity should work separately with wireless companies to ascertain their end user customers will be able to reach telephone relay services provided by dialing 711.
 - c) The TRS entity should work separately with competitive local exchange companies to ascertain their end user customers will be able to reach telephone relay services provided by dialing 711.
 - d) The TRS entity is restricted from selling or transferring the 711 dialing code to an unaffiliated entity, either directly or indirectly.
1. An "affiliate" of a TRS entity is any entity that directly, or indirectly through one or more intermediaries, controls, is controlled by, or is under common control with the TRS entity. The term "control" (including the terms "controlling," "controlled by," and "under common control with") means the possession, direct or indirect, of the power to direct or cause the direction of the management and policies of an entity, whether through the ownership of voting securities, by contract, or otherwise.

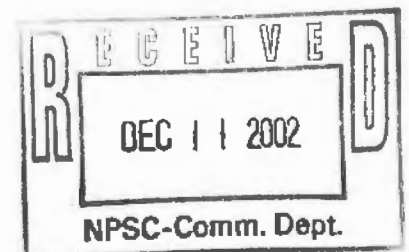

ISSUED:
December 11, 2002

BY: Warren D. Hannah
Director, Tariffs

EFFECTIVE:
December 23, 2002

GENERAL EXCHANGE TARIFF

UNITED TELEPHONE COMPANY
OF THE WEST
NEBRASKA

Section 19
Original Sheet 13

FCC DESIGNATED N11 SERVICE

B. 711 Service For Telecommunications Relay Services (TRS) (Cont'd)

2. Obligations of the TRS Entity (Cont'd)

- e) The 711 Dialing Code will be provided by the Company to the TRS entity under the following conditions:
1. For network sizing and protection, the TRS entity must provide an estimate of annual call volumes, the expected busy hour and the expected holding time for each call to the 711 dialing code.
 2. The TRS entity will subscribe to adequate telephone facilities initially and subsequently as may be required, in the judgment of the Company, to adequately handle calls to 711 without impairing the Company's general telephone service or telephone facilities.
 3. The TRS entity is responsible for obtaining all necessary permission, licenses, written consents, waivers, releases and all other rights from all persons whose work, statements or performance are used in connection with the 711 dialing code, and from all holders of copyrights, trademarks, and patents used in connection with said service.
- f) If a pre-recorded announcement is provided by the TRS entity, the following conditions apply:
1. The TRS entity will provide announcements. The company will provide only the delivery of the call.
 2. The provision of access to the 711 network by the Company for the transmission of announcement is subject to availability of such facilities and the requirements of the local exchange network.
 3. The TRS entity assumes all financial responsibility for all costs involved in providing announcement including, but not limited to, the recorder-announcement equipment located on the TRS entity's premises.
 4. The TRS entity assumes, according to other specific rates and charges under tariff, all financial responsibility for all facilities required, to connect the recorder-announcement equipment located on the TRS entity's premises.

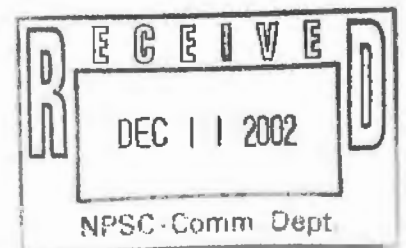

ISSUED:
December 11, 2002

BY: Warren D. Hannah
Director, Tariffs

EFFECTIVE:
December 23, 2002

GENERAL EXCHANGE TARIFF

UNITED TELEPHONE COMPANY
OF THE WEST
NEBRASKA

Section 19
Original Sheet 14

FCC DESIGNATED N11 SERVICE

B. 711 Service For Telecommunications Relay Services (TRS) (Cont'd)

3. Obligations of the Company

- a) Once the 711 Dialing Code has been assigned and the subscriber has provided the Company the appropriate toll free number, implementation of the 711 Dialing Code will begin. The Company will implement the TRS entity's request within a reasonable time, given the complexity of the order.

If, during or at the end of the provisioning period, the TRS entity has failed to establish service or decides to discontinue service establishment, the 711 code will be recalled and the number will be considered available for reassignment.

- b) When a 711 Service call is placed by the calling party via interconnection with an interexchange carrier, the Company cannot guarantee the completion of said 711 Service call, the quality of the call or any features that otherwise may be provided with 711 dialing service.

4. Obligations of the Competitive Local Exchange Carrier (CLEC)

- a) In those instances where a CLEC provides the 711 dialing code to its end user within the local calling area, terms and conditions for 711 dialing code are as defined in the appropriate Interconnection Agreement.

1. For purposes of providing a CLEC end user access to the TRS entity within the local calling area, appropriate arrangements must be made by the CLEC with the TRS entity serving the local calling area.
2. A CLEC may negotiate the provision of directory listing as defined in the Interconnection Agreement.

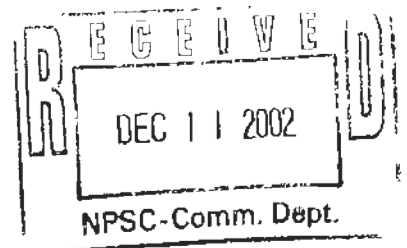

ISSUED:
December 11, 2002

BY: Warren D. Hannah
Director, Tariffs

EFFECTIVE:
December 23, 2002

GENERAL EXCHANGE TARIFF

UNITED TELEPHONE COMPANY
OF THE WEST
NEBRASKA

Section 19
Original Sheet 15

FCC DESIGNATED N11 SERVICE

B. 711 Service For Telecommunications Relay Services (TRS) (Cont'd)

5. Liability

- a) The TRS entity is responsible for, and shall indemnify, protect, defend and save harmless the Company against all suits, actions, claims, demands and judgments, and of all costs, expenses and counsel fees incurred on account thereof, arising out of and resulting directly or indirectly from the service or in connection therewith, including, but not limited to, any loss, damage, expense or liability resulting from any infringement or claim of infringement, of any patent, trademark, copyright, or resulting from any claim of libel and slander. Unless otherwise specifically provided in this Tariff, the Company shall be authorized to disconnect any tariffed service provided to the TRS entity utilized, directly or indirectly, with the 711 dialing code, which fails to comply with regulations and conditions set forth herein, upon five (5) days of notice to the subscriber. Disconnection may be suspended at the discretion of the Company if it receives written certification that the TRS entity is in compliance with regulations and conditions of the tariffs. Continual noncompliance shall be cause for disconnection without notice at the discretion of the Company.
- b) The TRS entity shall respond promptly to any and all complaints lodged with any regulatory authority against any service provided via the 711 dialing code. If requested by the Company, the TRS entity shall assist the Company in responding to complaints made to the Company concerning the 711 dialing code.
- c) A written notice will be sent to any TRS entity following oral notification when their service unreasonably interferes with or impairs other services rendered to the public by the Company. If after notification the TRS entity makes no modification in method of operation or in the service arrangements that are deemed service-protective by the Company, or if the TRS entity is unwilling to accept the modifications, or if the TRS entity continues to cause service impairment, the Company reserves the right, at any time, without further notice, to institute protective measures, up to and including termination of service. In an emergency situation as defined by the Company, the Company reserves the right, at any time, without notice, to institute protective measures up to and including termination of service.
- d) The Company may take all legal and practical steps to disassociate itself from the TRS entity providing services whose business and/or public conduct (whether demonstrated or proposed) is of a type that in the Company's discretion generates unacceptable levels of complaints by end users.

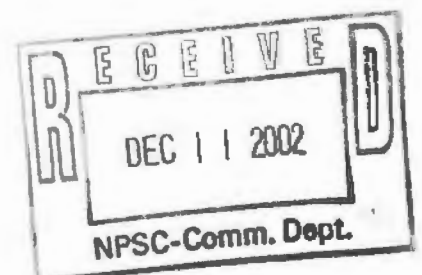

ISSUED:
December 11, 2002

BY: Warren D. Hannah
Director, Tariffs

EFFECTIVE:
December 23, 2002

GENERAL EXCHANGE TARIFF

UNITED TELEPHONE COMPANY
OF THE WEST
NEBRASKA

Section 19
Original Sheet 16

FCC DESIGNATED N11 SERVICE

B. 711 Service For Telecommunications Relay Services (TRS) (Cont'd)

5. Liability (Cont'd)

- e) In no event shall the Company be liable for any losses or damages of any kind resulting from the unavailability of its equipment or facilities or for any act, omission or failure of performance by the Company, or its employees, or agents, in connection with this Tariff. The Company shall not be responsible for calls that cannot be completed as a result of repair or maintenance difficulties on Company facilities and equipment nor on equipment owned or leased by the TRS entity.

6. Other Terms and Conditions

- a) Only one 10-digit toll free number may be used as the lead number per basic local calling area.
- b) The 711 Dialing Code is provided where facilities permit.
- c) The 711 Service will not provide calling number information in real time to the TRS entity. If this type of information is required, the TRS entity must subscribe to compatible Caller ID Service as described in Section 12 of the Price List.
- d) The 711 Service is provided solely for the benefit of the TRS entity. The provision of the 711 Service by the Company shall not be interpreted, constructed, or regarded, either expressly or implied, as being for the benefit of or creating any Company obligation toward any third person or legal entity other than the TRS entity.

7. Rates and Charges

- a) The 711 Service is ordered by the F.C.C. to be provided without charge. Therefore, there are no rates or charges for the 711 Service.

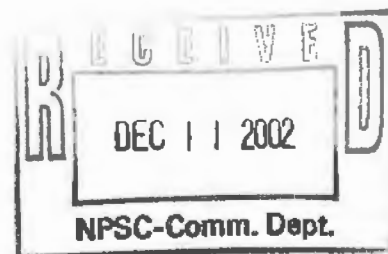

ISSUED:
December 11, 2002

BY: Warren D. Hannah
Director, Tariffs

EFFECTIVE:
December 23, 2002

GENERAL EXCHANGE TARIFF

UNITED TELEPHONE COMPANY
OF THE WEST
NEBRASKA

Section 19
Second Revised Sheet 32
Cancels First Revised Sheet 32

N11 SERVICES

E. 511 Service for Travel Information Services

1. General

- a) 511 Dialing Code ("511") is a three digit local dialing arrangement for telephone voice transmission access to all certified Travel Information Service entities as a toll free call. The Federal Communications Commission (FCC) assigned the 511 dialing code for nationwide access to Travel Information Services.
- b) The three digit 511 abbreviated dialing code is assigned to the Approved Travel Information Service Provider ("511 Provider") for use in providing community Travel Information services to the public by way of voice grade facilities.
- c) 511 is available from United Telephone Company of the West Nebraska within the Company's service area only. To provide access to 511 to end users in another company service area or to a Competitive Local Exchange Carrier (CLEC) end users within the local calling area, the 511 Provider must make appropriate arrangements with the other company or CLEC serving that territory. The 511 Provider should work separately with competing local providers to ascertain that its end user customers will be able to **Travel Information Services** provided by dialing 511.
- d) All 511 abbreviated dialing code calls must be local in nature and will not result in any intraLATA toll, interLATA long distance or pay-per-call charges to Company subscribers. However, 511 Service calls may result in measured service charges where Company subscribers' service plans include such charges as part of local measured service or home exchange service calling plans.
- e) The 511 Service is not available for the following classes of service: inmate service, 1+ and 0+ calling, 0- operator assisted calling and 101XXXX calling. 511 Service is otherwise available wherever local service is accessible.
- f) 511 Service is offered subject to the availability of facilities.

(Z)

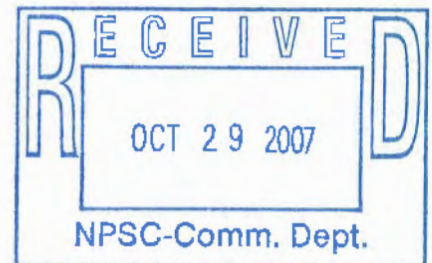

ISSUED:
October 29, 2007

BY: Darlene Terry
Manager, Tariffs

EFFECTIVE:
November 8, 2007

UNITED TELEPHONE COMPANY OF THE WEST - NEBRASKA
GENERAL EXCHANGE
PRICE LIST

SECTION 20
PAGE: 1
RELEASE: 1

ISSUED: December 29, 1994

EFFECTIVE: January 9, 1995

RESERVED FOR FUTURE USE

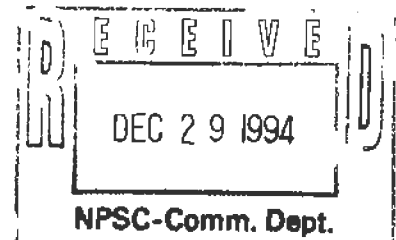

UNITED TELEPHONE COMPANY OF THE WEST - NEBRASKA
GENERAL EXCHANGE
PRICE LIST

SECTION 21
PAGE: 1
RELEASE: 1

ISSUED: December 29, 1994

EFFECTIVE: January 9, 1995

RESERVED FOR FUTURE USE

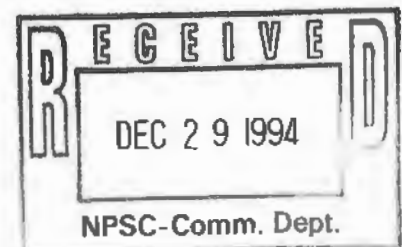

UNITED TELEPHONE COMPANY OF THE WEST - NEBRASKA
GENERAL EXCHANGE
PRICE LIST

SECTION 22

PAGE: 1

RELEASE: 2

ISSUED: May 29, 2001

EFFECTIVE: June 8, 2001

SIMPLIFIED MESSAGE DESK INTERFACE (SMDI)

I. **General**

(T)

- A. Simplified Message Desk Interface (SMDI) is a feature that provides an integrated, automated interface to customers who provide an answering bureau service or voice messaging service for their clients, and to PBX/Centrex customers that provide their own voice messaging service.
- B. SMDI furnishes the following call related information to an Enhanced Service Provider's Uniform Call Distribution (UCD) group. Enhanced Service Provider refers to any entity that furnishes answering and/or voice messaging service to clients.
1. Identification of the called station number.
 2. Identification of the calling station number when the call originates in the same central office that serves the customer.
 3. Identification of the type of Call Forwarding feature used by the called station number (Call Forwarding, Call Forwarding - Busy or No Answer).
 4. Identification of the UCD line receiving the call forwarded call.

This call related information is passed to the Enhanced Service Provider's message system via a data link from the central office to the Provider's premises.

- C. SMDI allows the Enhanced Service Provider to activate the Message Waiting Indicator feature on the called station number.
- D. Message Waiting Indicator (MWI) is an additional feature included with SMDI to lines located in the same central office in which the SMDI is provided. This feature provides for an audible interrupted (stuttered) dial tone, which allows an Enhanced Service Provider to supply their client's lines with a stuttered dial tone on a predesignated telephone number, to alert clients when a message is waiting.

II. **Rules and Regulations**

(T)

- A. The provider must have a hunt group arrangement in the same central office where the data channel terminates.
- B. A full duplex RS232 format data channel connected via modems is required to provide signaling between the central office and the Enhanced Service Provider's messaging equipment.

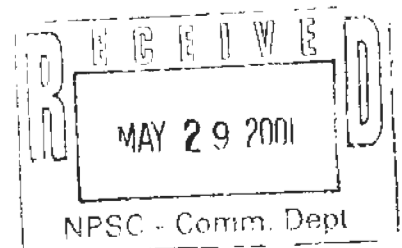

UNITED TELEPHONE COMPANY OF THE WEST - NEBRASKA
GENERAL EXCHANGE
PRICE LIST

SECTION 22

PAGE: 2

RELEASE: 2

ISSUED: May 29, 2001

EFFECTIVE: June 8, 2001

SIMPLIFIED MESSAGE DESK INTERFACE (SMDI)

II. **Rules and Regulations** (Cont'd)

(T)

- C. SMDI service requires the Enhanced Service Provider to have a UCD Group in the same central office where the data channel originates.
- D. SMDI is furnished only from central offices that have been arranged to provide this feature. The feature is provided subject to availability of facilities.
- E. In addition to the rates and charges associated with SMDI service, each line must be equipped with at least one of the following Call Forwarding features:
 - 1. Call Forwarding
 - 2. Call Forwarding - Busy
 - 3. Call Forwarding - No Answer

Rates, charges and regulations for these services are listed in the General Exchange Price List.

III. **Rates and Charges**

(T)

- A. The following rates and charges apply in addition to the applicable nonrecurring charges and monthly rates for the services with which these features are associated.

	<u>Monthly Rate</u>	<u>Non-recurring Charge</u>
SMDI Feature - per data link (FCEVFMI)	\$300.00	\$5,325.00

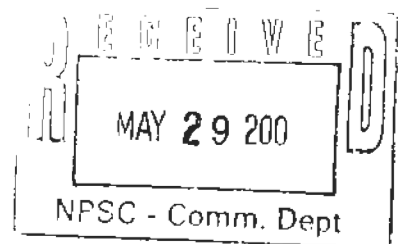

GENERAL EXCHANGE TARIFF
PRICE LIST

UNITED TELEPHONE COMPANY
OF THE WEST - NEBRASKA

Section 28
Original Page 1

INFO-LINK

I. SERVICE DESCRIPTION

INFO-LINK is a toll free, one-way service that allows end users to receive non-voice connection to an Internet Service Provider (ISP) located in a United Telephone Company specified foreign exchange. This service offering will allow end users to dial a seven digit number and receive connection to an Internet Service Provider located in a Telephone Company specified foreign exchange.

II. GENERAL REGULATIONS

- A. ISPs are defined as an Enhanced Service Provider whose service must include access to the Internet.
- B. INFO-LINK is designed and intended for the exclusive use for end user customers of United Telephone Company. INFO-LINK is not to be shared, resold or used in any configuration of customer-provided equipment with the intent of reselling this service. This service is available to interexchange carriers or other telecommunications service providers for administrative trunks only.
- C. It is the responsibility of the Telephone Company to determine what services meet the criteria of an Internet Service Provider. The sole purpose of the service offering is to allow affordable connection to the Internet. Enhanced Service Providers who provide services that do not include electronic data transfer to and from the Internet will not be considered ISPs.
- D. INFO-LINK is designed only to provide local one-way dialing to the Internet. This service is restricted to the transfer of electronic data. Voice traffic in conjunction with this service is prohibited.
- E. Unless otherwise specified, INFO-LINK is subject to the Rules and Regulations applying to all customer contracts as specified in the General Exchange Tariff of United Telephone Company.
- F. This service will be offered to end users only where technically available.
- G. The minimum service period for subscription to INFO-LINK is one month and is billed one month in advance.

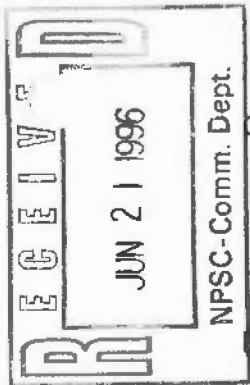

ISSUED:
June 21, 1996

BY: John L. Roe
Vice President
5454 West 110th Street
Overland Park, Kansas 66211

EFFECTIVE:
July 1, 1996

UNITED TELEPHONE COMPANY OF THE WEST - NEBRASKA
GENERAL EXCHANGE
PRICE LIST

SECTION 28

PAGE: 2

RELEASE: 5

ISSUED: June 16, 2009

EFFECTIVE: June 26, 2009

INFO-LINK

II. GENERAL REGULATIONS (Cont'd)

- H. INFO-LINK rates are incremental to charges paid by the customer for other services of the Telephone Company. Rates are on a per-line basis. This service can be used only in conjunction with Touch Tone Service and **Individual Line** or Trunk Local Exchange Service. (T)
- I. INFO-LINK will not be offered in conjunction with any Local Measured Service.

III. AVAILABILITY

- A. INFO-LINK service can only be provided in specially equipped telephone company central offices. The customers served by a specially equipped central office will have the ability to receive connection to an Internet service provider in a specific foreign exchange designated by the Telephone Company.
- B. When an ISP serves a given exchange and can be reached from that exchange without incurring toll charges, INFO-LINK will no longer be offered in that exchange.

IV. MONTHLY RATES:

Charge

	<u>S&E Code</u>	<u>Monthly Rate</u>	(T)
INFO-LINK service:			
Residential, per line	ASBEASC(INT)	\$10.00	
Business, per line	ASBEASC(INT)	\$10.00	
Centrex, per PAL ⁽¹⁾	ASBEASC(ICX)	\$10.00	(T)

⁽¹⁾ Info-Link access must be purchased on all PALs within a Centrex customer group.

(T)

GENERAL EXCHANGE TARIFF
PRICE LIST

UNITED TELEPHONE COMPANY
OF THE WEST - NEBRASKA

Section 28
Original Page 3

INFO-LINK

V. LIMITATION OF THE TELEPHONE COMPANY

- A. Liability for damages arising from the inability of this service to support services of an Internet Service Provider are limited to the cost of subscribing to INFO-LINK.
- B. The Telephone Company is in no way responsible for the content of data retrieved through the Internet Service Provider. INFO-LINK only provides one-way dialing to ISPs in foreign exchanges. The Telephone Company does not have the ability to monitor or restrict data provided through the connection to Internet Service Providers.

VI. OBLIGATION OF THE CUSTOMER

- A. The customer is responsible for purchasing any hardware or software necessary to access or utilize services of an Internet Service Provider.
- B. Any hardware or software purchased to access or utilize the services of an Internet Service Provider should be purchased after the customer has verified that the service can be technically supported from their customer premise.
- C. The end user is responsible for monitoring data received from the Internet Service Provider.
- D. At time of order, the customer will be asked to identify their ISP to assure service functionality.

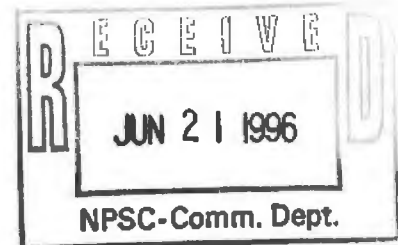

ISSUED:
June 21, 1996

BY: John L. Roe
Vice President
5454 West 110th Street
Overland Park, Kansas 66211

EFFECTIVE:
July 1, 1996

GENERAL EXCHANGE TARIFF

UNITED TELEPHONE COMPANY
OF THE WEST d/b/a CenturyLink
NEBRASKA

Section 1 (Z)
Second Revised Sheet 2
Cancels First Revised Sheet 2

ADVANCE PAYMENTS AND DEPOSITS

(D)

(D)

ISSUED:
November 18, 2015

BY: Darlene N. Terry
Manager, Tariffs

EFFECTIVE:
November 30, 2015

NE15-10