

Qwest Corporation
Access Service
Catalog

PREFACE PAGE

Page 1

Release 2

Effective: 4-1-2007

State of Nebraska
Notified: 3-21-2007

On January 13, 1999, the Nebraska Public Service Commission authorized the implementation of the Nebraska Universal Service Fund to ensure that all customers in Nebraska have access to affordable basic telephone service in a competitive market.

The Nebraska Public Service Commission established a new surcharge to fund the Nebraska Universal Service Fund. All customers of retail services in Nebraska will pay the monthly surcharge, which will be based on a percentage of their Access retail services. The surcharge is not assessed to customers of wholesale services.

The surcharge may be changed by order of the Nebraska Public Service Commission. See the Exchange and Network Services Catalog, Preface Page 1, for the effective surcharge rate.

(C)
|
(C)

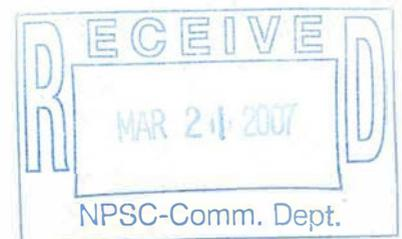

Qwest Corporation d/b/a CenturyLink QC
Access Service
Catalog

State of Nebraska
Notified: 03-20-2017

TITLE PAGE
Release 3
Effective: 03-31-2017

TERMS, CONDITIONS, RATES AND CHARGES

Applying to the provision of intrastate

ACCESS SERVICE

within the operating territory of

Qwest Corporation d/b/a CenturyLink QC

Whether offered under the name, or the trade or brand name CenturyLink (T)

in the State of

NEBRASKA

(Company Code 5143)

ADOPTION NOTICE

Effective April 1, 2011, Qwest Corporation registered the fictitious name CenturyLink QC. Effective August 8, 2011, Qwest Corporation began operating under the name CenturyLink QC. As such, Qwest Corporation d/b/a CenturyLink QC hereby adopts, ratifies and makes its own, in every respect as if the same had been originally filed by it, all schedules, rules, notices, concurrences, schedule agreements, divisions, authorities or other instruments whatsoever, filed with the Nebraska Public Service Commission, State of Nebraska, by or adopted by Qwest Corporation.

By this notice, Qwest Corporation d/b/a CenturyLink QC also adopts and ratifies all supplements or amendments to any of the above schedules, etc., which Qwest Corporation has heretofore filed with said Commission.

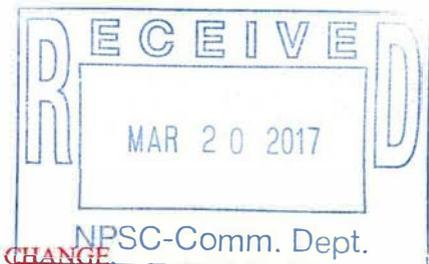

Qwest Corporation
Access Service
Catalog

SECTION 1
Index Page 1
Release 1

State of Nebraska
Notified: 9-29-2000

Effective: 9-29-2000

1. APPLICATION AND REFERENCE

SUBJECT	PAGE
Application of Catalog.....	1
Catalog Format.....	22
Explanation of Abbreviations	25
Explanation of Change Symbols.....	24
Reference to Other Publications	34
Reference to Other Catalogs	29
Reference to Technical Publications.....	30
Subject Index	14
Table of Contents.....	2
Trademarks, Service Marks and Trade Names	29

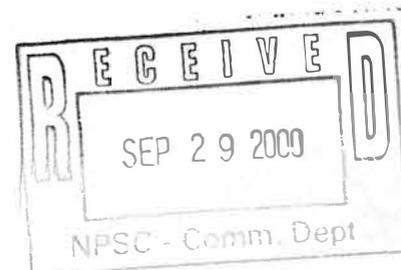

Qwest Corporation d/b/a CenturyLink QC

Access Service
Catalog

SECTION 1

Page 1

Release 2

Effective: 8-8-2011

(C)

State of Nebraska
Notified: 7-28-2011

1. APPLICATION AND REFERENCE

1.1 APPLICATION OF CATALOG

This Catalog contains regulations, terms, conditions, rates and charges applicable to the provision of Carrier Common Line, Switched Access Service, Expanded Interconnection Service and other miscellaneous services, hereinafter referred to collectively as service(s), provided by Qwest Corporation d/b/a CenturyLink QC, hereinafter referred to as the Company. The regulated services offered herein by Qwest Corporation d/b/a CenturyLink QC, whether under that name or the trade or brand name CenturyLink, are subject to the terms and conditions of this Catalog.

(T)

(C)

(C)

The provision of such service by the Company as set forth in this Catalog is specifically intended to provide exchange network access to customers as follows:

- Providers of interexchange service, that furnish service between Local Calling Areas, must purchase services from this Catalog for their use in furnishing their authorized intrastate telecommunications services to end user customers, and for operational purposes directly related to the furnishing of such services.
- Any customer, including but not limited to, Telecommunications Companies and/or Interexchange Carriers, may purchase certain services from this Catalog for their own or administrative use, as specified in other sections of this Catalog. Services provided for a customer's own or administrative use may be subject to the rates and charges of other catalogs or tariffs of the Company.

The provision of such services by the Company as set forth in this Catalog does not constitute a joint undertaking with the customer for the furnishing of any service.

The terms, conditions, rates and charges contained herein are in addition to the applicable terms, conditions, rates and charges specified in other catalogs of the Company which are referenced herein.

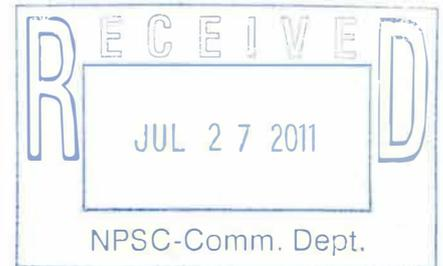

Qwest Corporation d/b/a CenturyLink QC

**Access Service
Catalog**

SECTION 1
Page 2
Release 2
Effective: 03-31-2017

(C)

State of Nebraska
Notified: 03-20-2017

1. APPLICATION AND REFERENCE

1.2 TABLE OF CONTENTS

PAGE

SECTION 1. APPLICATION AND REFERENCE

1.1	APPLICATION OF CATALOG	1
1.2	TABLE OF CONTENTS	2
1.3	SUBJECT INDEX.....	14
1.4	CATALOG FORMAT	22
1.4.1	LOCATION OF MATERIAL	22
1.4.2	OUTLINE STRUCTURE.....	22
1.4.3	RATE TABLES.....	23
1.4.4	RESERVED FOR FUTURE USE	23
1.5	EXPLANATION OF CHANGE SYMBOLS.....	24
1.6	EXPLANATION OF ABBREVIATIONS	25
1.7	TRADEMARKS, SERVICE MARKS AND TRADE NAMES	29
1.8	REFERENCE TO OTHER CATALOGS	29
1.9	REFERENCE TO TECHNICAL PUBLICATIONS	30
1.10	REFERENCE TO OTHER PUBLICATIONS	34

(T)

SECTION 2. GENERAL REGULATIONS

2.1	UNDERTAKING OF THE COMPANY	1
2.1.1	SCOPE	1
2.1.2	LIMITATIONS	1
2.1.3	LIABILITY	3
2.1.4	PROVISION OF SERVICES.....	4
2.1.5	INSTALLATION AND TERMINATION OF SERVICES	5
2.1.6	MAINTAINING SERVICES	5
2.1.7	CHANGES AND SUBSTITUTIONS	5
2.1.8	REFUSAL AND DISCONTINUANCE OF SERVICES	6
2.1.9	LIMITATION OF USE OF METALLIC FACILITIES	7
2.1.10	NOTIFICATION OF SERVICE-AFFECTING ACTIVITIES.....	8
2.1.11	COORDINATION WITH RESPECT TO NETWORK CONTINGENCIES.....	8
2.1.12	PROVISION AND OWNERSHIP OF TELEPHONE NUMBERS.....	8

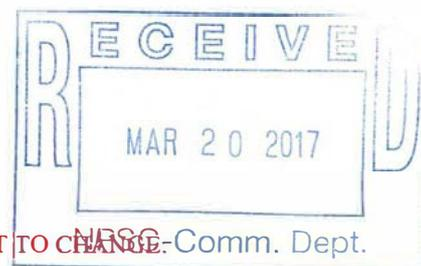

Qwest Corporation
Access Service
Catalog

SECTION 1

Page 3

Release 1

State of Nebraska
Notified: 9-29-2000

Effective: 9-29-2000

1. APPLICATION AND REFERENCE

1.2 TABLE OF CONTENTS (Cont'd)

	PAGE
2.2 USE.....	9
2.2.1 INTERFERENCE OR IMPAIRMENT AND UNLAWFUL USE	9
2.3 OBLIGATIONS OF THE CUSTOMER.....	10
2.3.1 DAMAGES	10
2.3.2 OWNERSHIP OF FACILITIES.....	10
2.3.3 EQUIPMENT SPACE AND POWER.....	10
2.3.4 AVAILABILITY FOR TESTING.....	11
2.3.5 BALANCE.....	11
2.3.6 DESIGN OF CUSTOMER SERVICES.....	11
2.3.7 REFERENCES TO THE COMPANY.....	11
2.3.8 CLAIMS AND DEMANDS FOR DAMAGES.....	12
2.3.9 COORDINATION WITH RESPECT TO NETWORK CONTINGENCIES.....	13
2.3.10 JURISDICTIONAL REPORT REQUIREMENTS	13
2.3.11 DETERMINATION OF JURISDICTION FOR MIXED INTERSTATE AND INTRASTATE ACCESS SERVICE BILLING.....	29
2.3.12 DETERMINATION OF INTRASTATE CHARGES FOR MIXED INTERSTATE AND INTRASTATE ACCESS SERVICE.....	30
2.3.13 DETERMINATION OF THE CUSTOMER OF RECORD WHEN SWITCHED ACCESS SERVICE CONNECTS TO EXPANDED INTERCONNECTION SERVICE.....	31

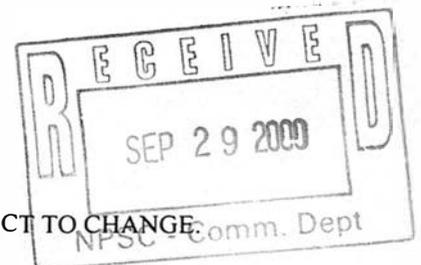

Qwest Corporation
Access Service
Catalog

SECTION 1

Page 4

Release 1

Effective 9-29-2000

State of Nebraska
Notified: 9-29-2000

1. APPLICATION AND REFERENCE

1.2 TABLE OF CONTENTS (Cont'd)

	PAGE
2.4 PAYMENT ARRANGEMENTS AND CREDIT ALLOWANCES	32
2.4.1 PAYMENT OF RATES, CHARGES AND DEPOSITS	32
2.4.2 MINIMUM PERIODS	36
2.4.3 CANCELLATION OF AN ORDER FOR SERVICE	36
2.4.4 CREDIT ALLOWANCE FOR SERVICE INTERRUPTIONS	36
2.4.5 REESTABLISHMENT OF SERVICE FOLLOWING FIRE, FLOOD OR OTHER OCCURRENCE	39
2.4.6 TITLE OR OWNERSHIP RIGHTS	39
2.4.7 ORDERING, RATING AND BILLING OF ACCESS SERVICES WHERE MORE THAN ONE EXCHANGE TELEPHONE COMPANY IS INVOLVED	40
2.4.8 ORDERING, RATING AND BILLING OF SWITCHED ACCESS PROVIDED IN CONJUNCTION WITH A COMMERCIAL MOBILE RADIO SERVICE PROVIDER	50
2.5 CONNECTIONS	51
2.5.1 GENERAL	51
2.6 DEFINITIONS	52
2.7 SHARED USE REGULATIONS	80
2.7.1 DS1 AND DS3 PLTS WITH SWITCHED ACCESS SERVICE	81
2.7.2 EXPANDED INTERCONNECTION CHANNEL TERMINATION	83
2.7.3 SWITCHED DS3 FACILITY WITH CCSAC SERVICE	83

SECTION 3. CARRIER COMMON LINE ACCESS SERVICE

3.1 GENERAL DESCRIPTION	1
3.2 LIMITATIONS	1
3.2.1 EXCLUSIONS	1
3.2.2 ACCESS GROUPS	1
3.2.3 WATS ACCESS LINES	1
3.3 UNDERTAKING OF THE COMPANY	2
3.3.1 PROVISION OF SERVICE	2
3.3.2 INTERSTATE AND INTRASTATE USE	2

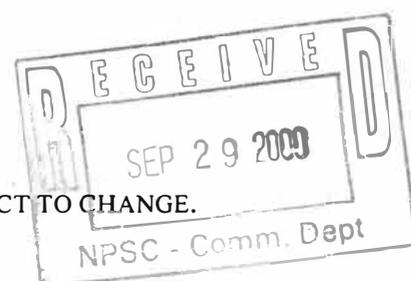

State of Nebraska
Notified: 5-9-2013

1. APPLICATION AND REFERENCE

1.2 TABLE OF CONTENTS (Cont'd)

	PAGE
3.4 OBLIGATIONS OF THE CUSTOMER	2
3.4.1 SWITCHED ACCESS SERVICE REQUIREMENT	2
3.4.2 SUPERVISION	2
3.5 DETERMINATION OF USAGE SUBJECT TO CARRIER COMMON LINE ACCESS CHARGES	2
3.5.1 DETERMINATION OF JURISDICTION	2
3.5.3 LOCAL EXCHANGE ACCESS AND ENHANCED SERVICES EXEMPTION	3
3.5.4 SWITCHED ACCESS SERVICE PROVIDED IN CONJUNCTION WITH A COMMERCIAL MOBILE RADIO SERVICE PROVIDER	3
3.5.5 COMMON CHANNEL SIGNALING ACCESS CAPABILITY EXEMPTION	3
3.6 RESOLD SERVICES	4
3.6.1 SCOPE	4
3.6.2 CUSTOMER OBLIGATIONS CONCERNING THE RESALE OF MTS AND MTS-TYPE SERVICES	5
3.6.3 RESALE DOCUMENTATION PROVIDED BY THE CUSTOMER	5
3.6.4 RATE TERMS AND CONDITIONS CONCERNING THE RESALE OF MTS AND MTS-TYPE SERVICES	6
3.7 RATE TERMS AND CONDITIONS	10
3.7.1 BILLING OF CHARGES	10
3.7.2 DENSITY ZONE PRICING PLAN	10
3.7.3 PAYMENT OPTIONS	10
3.7.5 UNMEASURED FEATURE GROUP A AND B USAGE	11
3.7.6 PERCENT INTERSTATE USE (PIU)	11
3.7.7 DETERMINATION OF RATES	11
3.8 RATES	12

Qwest Corporation
Access Service
Catalog

SECTION 1
Page 6
Release 1
Effective: 9-29-2000

State of Nebraska
Notified: 9-29-2000

1. APPLICATION AND REFERENCE

1.2 TABLE OF CONTENTS (Cont'd)

	PAGE
SECTION 4. RESERVED FOR FUTURE USE	
SECTION 5. ORDERING OPTIONS FOR ACCESS SERVICES	
5.1 GENERAL	1
5.1.1 ORDERING CONDITIONS	1
5.1.2 PROVISION OF OTHER SERVICES	2
5.1.3 SPECIAL CONSTRUCTION	2
5.2 ACCESS ORDER	3
5.2.1 ACCESS ORDER SERVICE DATE INTERVALS	12
5.2.2 ACCESS ORDER MODIFICATIONS	13
5.2.3 CANCELLATION OF AN ACCESS ORDER.....	18
5.2.4 SELECTION OF FACILITIES FOR ACCESS ORDERS.....	21
5.2.5 MINIMUM PERIOD	21
5.2.6 MINIMUM PERIOD CHARGES	23
5.2.7 SHARED USE FACILITIES.....	23
5.2.8 DISCONTINUANCE OF ACCESS SERVICE.....	23

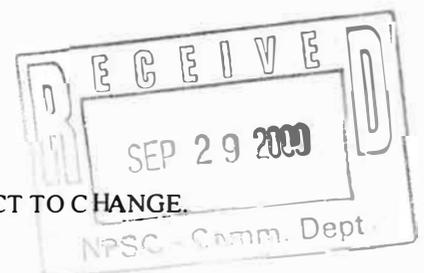

1. APPLICATION AND REFERENCE

1.2 TABLE OF CONTENTS (Cont'd)

	PAGE
SECTION 6. SWITCHED ACCESS SERVICE	
6.1	GENERAL 1
6.1.1	SWITCHED ACCESS SERVICE ARRANGEMENTS AND MANNER OF PROVISION 1
6.1.2	RATE CATEGORIES..... 3
6.1.3	SPECIAL FACILITIES ROUTING..... 34
6.1.4	DESIGN LAYOUT REPORT..... 34
6.1.5	ACCEPTANCE TESTING..... 35
6.1.6	ORDERING OPTIONS AND CONDITIONS 35
6.1.7	SPECIAL HIGH VOLTAGE PROTECTIVE APPARATUS 35
6.2	PROVISION AND DESCRIPTION OF SWITCHED ACCESS SERVICE 35
6.2.1	FEATURE GROUP A (FGA) 37
6.2.2	FEATURE GROUP B (FGB)..... 44
6.2.3	FEATURE GROUP C (FGC) 48
6.2.4	FEATURE GROUP D (FGD) 54
6.2.5	800 DATA BASE ACCESS SERVICE..... 61
6.2.6	900 ACCESS SERVICE..... 65
6.3	COMMON SWITCHING, TRANSPORT TERMINATION AND LINE TERMINATION OPTIONAL FEATURES 67
6.3.1	COMMON SWITCHING OPTIONAL FEATURES 67
6.3.2	TRANSPORT TERMINATION OPTIONAL FEATURES 81
6.4	TRANSMISSION SPECIFICATIONS 84



Qwest Corporation
Access Service
Catalog

SECTION 1
Page 8
Release 2
Effective: 02-15-2001

State of Nebraska
Notified: 02-05-2001

1. APPLICATION AND REFERENCE

1.2 TABLE OF CONTENTS (Cont'd)

	PAGE
6.5 OBLIGATIONS OF THE COMPANY	85
6.5.1 NETWORK MANAGEMENT	85
6.5.2 DESIGN AND TRAFFIC ROUTING OF SWITCHED ACCESS SERVICE	86
6.5.3 DS1 RECORDS ASSIGNMENT	86
6.5.4 MULTIPLEXING	86
6.5.5 PROVISION OF SERVICE PERFORMANCE DATA	87
6.5.6 TRUNK GROUP MEASUREMENT REPORTS	87
6.5.7 DETERMINATION OF NUMBER OF TRANSMISSION PATHS	87
6.5.8 DETERMINATION OF NUMBER OF END OFFICE TRANSPORT TERMINATIONS	88
6.5.9 DESIGN BLOCKING PROBABILITY	88
6.5.10 END USER LINE AND USAGE INFORMATION DATA	91
6.6 OBLIGATIONS OF THE CUSTOMER	92
6.6.1 ORDERING REQUIREMENTS	92
6.6.2 REPORT REQUIREMENTS	92
6.6.3 SUPERVISORY SIGNALING	93
6.6.4 TRUNK GROUP MEASUREMENTS REPORTS	93
6.6.5 DESIGN OF SWITCHED ACCESS SERVICE	93
6.7 RATE TERMS AND CONDITIONS	94
6.7.1 DESCRIPTION AND APPLICATION OF RATES AND CHARGES	94
6.7.2 MINIMUM PERIODS	112
6.7.3 MINIMUM MONTHLY CHARGE	112
6.7.4 CHANGE OF SWITCHED ACCESS INTERFACE GROUP CATEGORY	112
6.7.5 CHANGE OF SWITCHED ACCESS SERVICE TYPE	114
6.7.6 MOVES	115
6.7.7 MEASURING ACCESS MINUTES	121
6.7.8 APPLICATION OF RATES FOR EXTENSION SERVICE	128
6.7.9 MESSAGE UNIT CREDIT	128
6.7.10 LOCAL INFORMATION DELIVERY SERVICES	128
6.7.11 MILEAGE MEASUREMENT	129
6.7.12 SHARED USE	132
6.7.14 PERCENT DIRECT ROUTED FACTOR	133

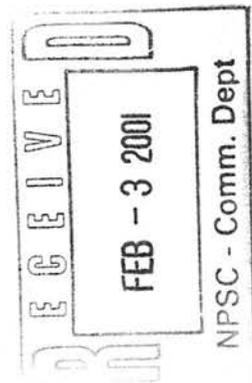

(D)

Qwest Corporation
Access Service
Catalog

State of Nebraska
Notified: 7-26-2006

SECTION 1
Page 9
Release 5
Effective: 8-7-2006

1. APPLICATION AND REFERENCE

1.2 TABLE OF CONTENTS (Cont'd)

	PAGE
6.8 RATES AND CHARGES	134
6.8.1 SWITCHED TRANSPORT	134
6.8.2 LOCAL SWITCHING	145
6.8.3 MESSAGE UNIT CREDIT.....	152

SECTION 7. RESERVED FOR FUTURE USE

SECTION 8. RESERVED FOR FUTURE USE

(C)

(D)

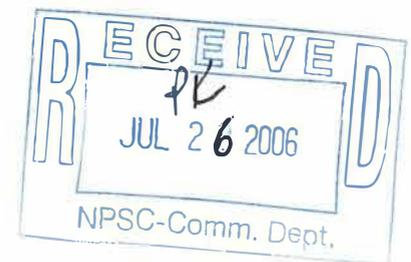

Qwest Corporation
Access Service
Catalog

SECTION 1
Page 10
Release 2
Effective: 11-01-2002

State of Nebraska
Notified: 10-22-2002

1. APPLICATION AND REFERENCE

1.2 TABLE OF CONTENTS (Cont'd)

	PAGE	
SECTION 9. DIRECTORY ASSISTANCE SERVICE		
9.1	GENERAL DESCRIPTION.....	1
9.2	UNDERTAKING OF THE COMPANY.....	1 (T)
9.3	OBLIGATIONS OF THE CUSTOMER.....	6 (D)
9.4	RATE TERMS AND CONDITIONS.....	7 (T)
9.5	RATES AND CHARGES	10 (D)

SECTION 10. RESERVED FOR FUTURE USE

**SECTION 11. SPECIAL FACILITIES ROUTING
OF ACCESS SERVICE**

11.1	DESCRIPTION	1
11.2	RATES AND CHARGES	2

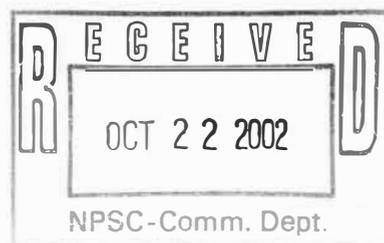

Qwest Corporation
Access Service
Catalog

SECTION 1
Page 11
Release 3
Effective: 10-14-2002

State of Nebraska
Notified: 10-02-2002

1. APPLICATION AND REFERENCE

1.2 TABLE OF CONTENTS (Cont'd)

	PAGE	
SECTION 12. SPECIALIZED SERVICE OR ARRANGEMENTS		
12.1	GENERAL	1
12.2	MOVE CHARGES	1
12.3	RATES AND CHARGES	2
SECTION 13. ADDITIONAL ENGINEERING, ADDITIONAL LABOR AND MISCELLANEOUS SERVICES		
13.1	ADDITIONAL ENGINEERING	1
13.2	ADDITIONAL LABOR	1
13.2.1	OVERTIME INSTALLATION	1
13.2.2	OTHER LABOR	1
13.3	MISCELLANEOUS SERVICES	2
13.3.1	MAINTENANCE OF SERVICE	2
13.3.2	TELECOMMUNICATIONS SERVICE PRIORITY (TSP)	3
13.3.3	INTEREXCHANGE CARRIER SUBSCRIPTION	4
13.3.4	STANDARD JACKS - REGISTRATION PROGRAM	10
13.3.5	TESTING SERVICES	11
13.3.6	PROVISION OF ACCESS SERVICE BILLING INFORMATION	15
13.3.7	SPECIAL HIGH VOLTAGE PROTECTIVE APPARATUS	15
13.3.8	MANAGED LONG DISTANCE (MLD)	16.1 (N)
13.4	RATES AND CHARGES	17
13.4.1	CHARGES FOR ADDITIONAL ENGINEERING	17
13.4.2	CHARGES FOR ADDITIONAL LABOR	18
13.4.3	CHARGES FOR MISCELLANEOUS SERVICE	20

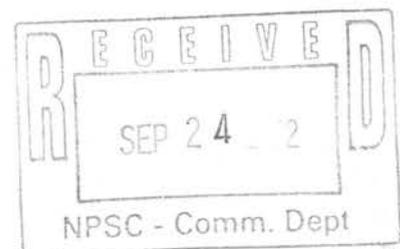

Qwest Corporation
Access Service
Catalog

SECTION 1
Page 12
Release 2

State of Nebraska
Notified: 05-25-2001

Effective: 06-06-2001

1. APPLICATION AND REFERENCE

1.2 TABLE OF CONTENTS (Cont'd)

	PAGE	
SECTION 14. RESERVED FOR FUTURE USE		
SECTION 15. COMMON CHANNEL SIGNALING NETWORK (CCSN)		
15.1	GENERAL DESCRIPTION	1 (T)
15.2	SERVICE DESCRIPTION.....	2
15.2.1	COMMON CHANNEL SIGNALING ACCESS CAPABILITY (CCSAC).....	2 (T)
15.3	RATE CATEGORIES	4
15.3.1	CCSAC RATE CATEGORIES.....	4
15.4	REPORT REQUIREMENTS.....	6 (T)
15.4.1	CCSAC NETWORK MANAGEMENT.....	6
15.5	ORDERING, SERVICE PROVISIONING AND PERFORMANCE REQUIREMENTS	6
15.5.1	CCSAC ORDERING REQUIREMENTS.....	6
15.5.2	CCSAC SERVICE PROVISIONING.....	7
15.5.3	CCSAC PERFORMANCE REQUIREMENTS.....	8
15.6	TESTING REQUIREMENTS.....	8
15.6.1	CCSAC ACCEPTANCE TESTING REQUIREMENTS.....	8
15.6.2	CCSAC ADDITIONAL COOPERATIVE ACCEPTANCE TESTING REQUIREMENT	9
15.7	CCSAC SERVICE APPLICATIONS.....	9
15.7.1	CALL SET-UP.....	9
15.7.2	FOREIGN DATABASE QUERIES	9
15.8	RATES AND CHARGES	10 (T)

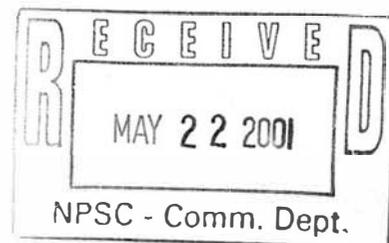

Qwest Corporation
Access Service
Catalog

State of Nebraska
Notified: 9-29-2000

SECTION 1
Page 13
Release 1
Effective: 9-29-2000

1. APPLICATION AND REFERENCE

1.2 TABLE OF CONTENTS (Cont'd)

	PAGE
SECTION 21. EXPANDED INTERCONNECTION (EI) SERVICE	
21.1 GENERAL.....	1
21.2 SERVICE DESCRIPTION.....	3
21.2.1 EXPANDED INTERCONNECTION CHANNEL TERMINATION	3
21.3 RATE TERMS AND CONDITIONS.....	4
21.3.1 TYPES OF RATES AND CHARGES	4
21.4 RATES AND CHARGES	6
21.4.1 SWITCHED ACCESS SERVICE VIRTUAL EI	6

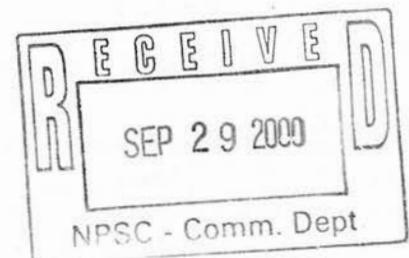

Qwest Corporation
Access Service
Catalog

State of Nebraska
Notified: 09-18-2002

SECTION 1
Page 14
Release 2
Effective: 09-30-2002

1. APPLICATION AND REFERENCE

1.3 SUBJECT INDEX

SUBJECT	SECTION	
800 Data Base Access Service	6	
900 Access Service	6	
Acceptance Testing.....	6	
Access Groups	3	
Access Order.....	5	
Access Order Modifications	5	
Access Order Service Date Intervals	5	
Access Order Standard Intervals.....	5	
Additional Engineering.....	13	
Additional Engineering, Additional Labor and Miscellaneous Services.....	13	
Additional Labor.....	13	
Application and Reference.....	1	(D)
Application of Catalog.....	1	
Application of Rates for Extension Service.....	6	
Audit Provisions	4	
Availability for Testing.....	2	
Avoidance	11	
Balance.....	2	
Billing of Charges.....	3	(D)

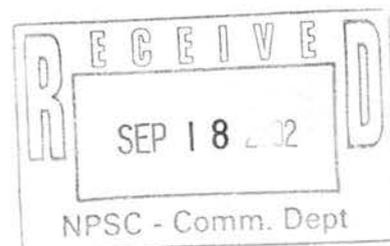

Qwest Corporation
Access Service
Catalog

State of Nebraska
 Notified: 09-18-2002

SECTION 1
 Page 15
 Release 2
 Effective: 09-30-2002

1. APPLICATION AND REFERENCE

1.3 SUBJECT INDEX (Cont'd)

SUBJECT	SECTION	
Cable-Only Facilities	11	
Cancellation of an Access Order	5	
Cancellation of an Order for Service	2	
Carrier Common Line Access Service.....	3	
Catalog Format.....	1	
CCSAC Acceptance Testing Requirements.....	15	
CCSAC Additional Cooperative Acceptance Testing Requirements.....	15	
CCSAC Ordering Requirements.....	15	
CCSAC Rate Categories	15	
Change of Switched Access Interface Group Category.....	6	
Change of Switched Access Service Type	6	
Changes and Substitutions	2	
Claims and Demands for Damages.....	2	
Common Channel Signaling Access Capability (CCSAC)	15	
Common Channel Signaling Access Capability Exemption	3	
Common Channel Signaling Network (CCSN).....	15	
Common Switching Optional Features.....	6	
Common Switching, Transport Termination and Line Termination Optional Features.....	6	
Connections	2	
Coordination with Respect to Network Contingencies.....	2	(D)
Credit Allowance for Service Interruptions.....	2	(D)
Customer Obligations Concerning the Resale of MTS and MTS-Type Services	3	

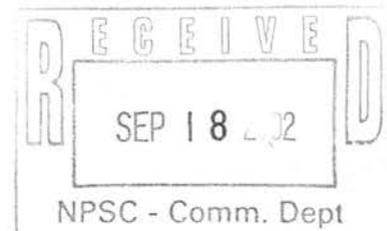

State of Nebraska

Notified: 5-9-2013

1. APPLICATION AND REFERENCE

1.3 SUBJECT INDEX (Cont'd)

SUBJECT	SECTION
Damages	2
Data Transmission Parameters	6
Definitions	2
Density Zone Pricing Plan	3
Design and Traffic Routing of Switched Access Service.....	6
Design Blocking Probability	6
Design Change Charge	5
Design Layout Report.....	6
Design of Customer Service.....	2
Design of Switched Access Services	6
Determination of Interstate Charges for Mixed Interstate and Intrastate Access Service	2
Determination of Jurisdiction.....	3
Determination of Number of End Office Transport Terminations.....	6
Determination of Number of Transmission Paths	6
Determination of Rates.....	3
Determination of Usage Subject to Carrier Common Line Access Charges	3
Directory Assistance Service.....	9
Discontinuance of Access Service.....	5
Diversity	11
End User Line and Usage Information Data.....	6
Equipment Space and Power.....	2
Exclusions	3
Expanded Interconnection Service.....	21
Expedited Order Charge.....	5
Explanation of Abbreviations.....	1
Explanation of Change Symbols	1
Feature Group A (FGA)	6
Feature Group B (FGB).....	6
Feature Group C (FGC).....	6
Feature Group D (FGD)	6
General Regulations	2

(C-M)

(M) Material moved from Page 21.

NOTICE

THE INFORMATION CONTAINED IN THIS DOCUMENT IS SUBJECT TO CHANGE.
NE2013-002

Qwest Corporation
Access Service
Catalog

SECTION 1
Page 17
Release 5
Effective: 1-11-2012

State of Nebraska
Notified: 12-30-2011

1. APPLICATION AND REFERENCE

1.3 SUBJECT INDEX (Cont'd)

SUBJECT	SECTION	
Identification and Rating of VoIP-PSTN Traffic	2	(N)
Installation and Termination of Services.....	2	
Interexchange Carrier Subscription	13	
Interference or Impairment.....	2	
Interstate and Intrastate Use	3	
Jurisdictional Report Requirements	2	
Late Payment Penalty	2	
Liability	2	
Limitation of Use of Metallic Facilities	2	
Limitations		
Carrier Common Line Access Service	3	
General Regulations	2	
Local Exchange Access and Enhanced Services Exemption	3	
Local Information Delivery Services.....	6	
Local Switching.....	6	
Local Transport	6	
Maintaining Services.....	2	
Maintenance of Service	13	
Managed Long Distance (MLD)	13	
Measuring Access Minutes	6	
Message Unit Credit.....	6	
Mileage Measurement	6	
Minimum Monthly Charge.....	6	
Minimum Period Charges	5	
Minimum Periods.....	2	
Common Channel Signaling Network (CCSN)	15	
General Regulations	2	
Ordering Options for Access Services	5	
Switched Access Service.....	6	
Miscellaneous Services	13	
Moves.....	6	

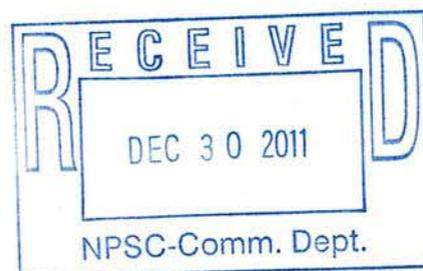

Qwest Corporation
Access Service
Catalog

SECTION 1
Page 18
Release 3

State of Nebraska
Notified: 09-18-2002

Effective: 09-30-2002

1. APPLICATION AND REFERENCE

1.3 SUBJECT INDEX (Cont'd)

SUBJECT	SECTION	
Network Management		
Common Channel Signaling Network (CCSN).....	15	
Switched Access Service	6	
Notification of Service-Affecting Activities.....	2	(D)
Obligations of the Company		
Carrier Common Line Access Service.....	3	
Directory Assistance Service	9	
General Regulations.....	2	
Switched Access Service	6	
Optional Calling Plan Usage Credit.....	6	
Ordering Conditions	5	
Ordering Options and Conditions		
Common Channel Signaling Network (CCSN).....	15	
Switched Access Service	6	
Ordering Options for Access Services.....	5	
Ordering, Rating and Billing of Access Services Where More Than One Exchange Company is Involved.....	2	
Ordering, Rating and Billing of Switched Access Provided in Conjunction with a Commercial Mobile Radio Service Provider.....	2	
Other Labor.....	13	
Overtime Installation	13	
Ownership of Facilities.....	2	
Payment Arrangements.....	9	
Payment Arrangements and Credit Allowances	2	
Payment Due Date	2	
Payment of Rates, Charges and Deposits	2	
Payment Options.....	3	
Percent Interstate Use (PIU)	2	

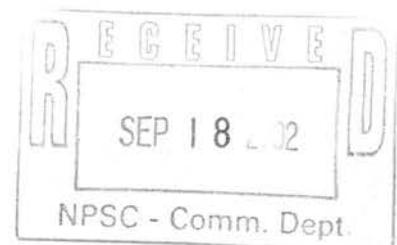

Qwest Corporation
Access Service
Catalog

SECTION 1
Page 19
Release 2

State of Nebraska
Notified: 09-18-2002

Effective: 09-30-2002

1. APPLICATION AND REFERENCE

1.3 SUBJECT INDEX (Cont'd)

SUBJECT	SECTION
Provision and Description of Switched Access Service	6
Provision and Ownership of Telephone Numbers	2
Provision of Access Service Billing Information	13
Provision of Other Services	5
Provision of Service	3
Provision of Service Performance Data	6
Provision of Services	2
Rate Categories	
Common Channel Signaling Network (CCSN)	15
Switched Access Service	6
Rate Terms and Conditions	
Carrier Common Line Access Service	3
Common Channel Signaling Network (CCSN)	15
Directory Assistance Service	9
Switched Access Service	6
Rate Terms and Conditions Concerning the Resale of MTS and MTS-Type Services	3
Rates and Charges	
Carrier Common Line Access Service	3
Common Channel Signaling Network (CCSN)	15
Directory Assistance Service	9
Switched Access Service	6
Reestablishment of Service Following Fire, Flood or Other Occurrence	2
Reference to Other Catalogs	1
Reference to Other Publications	1
Reference to Technical Publications	1
References to the Company	2
Refusal and Discontinuance of Services	2
Report Requirements	
Common Channel Signaling Network (CCSN)	15
Switched Access Service	6
Resale Documentation Provided by the Customer	3
Resold Services	3

(D)

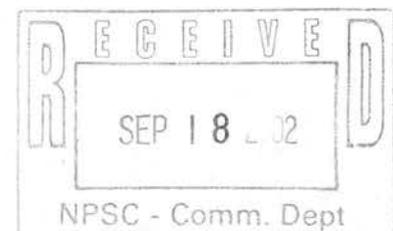

Qwest Corporation
Access Service
Catalog

SECTION 1
Page 20
Release 1
Effective: 9-29-2000

State of Nebraska
Notified: 9-29-2000

1. APPLICATION AND REFERENCE

1.3 SUBJECT INDEX (Cont'd)

SUBJECT	SECTION
Scope	2
Selection of Facilities for Access Orders	5
Service Date Change.....	5
Shared Use	2
Shared Use Facilities	5
Special Construction	5
Special Facilities Routing	6
Special Facilities Routing of Access Services.....	11
Special High Voltage Protective Apparatus	
Switched Access Service	6
Miscellaneous Services.....	13
Specialized Service or Arrangement.....	12
Standard Jacks - Registration Program	13
Standard Transmission Specifications	6
Subject Index	1
Supervision	3
Supervisory Signaling	6
Switched Access Service	6
Switched Access Service Arrangements and Manner of Provision	6
Switched Access Service Provided in Conjunction with a Commercial Mobile Radio Service Provider.....	3
Switched Access Service Requirement.....	3
Switched Transport.....	6
Table of Contents.....	1
Telecommunications Service Priority (TSP)	13
Testing Requirements	15
Testing Services	13
Title or Ownership Rights	2
Trademarks, Service Marks and Trade Names	1
Transmission Specifications	6
Transport Termination Optional Features	6
Trunk Group Measurement Reports	6

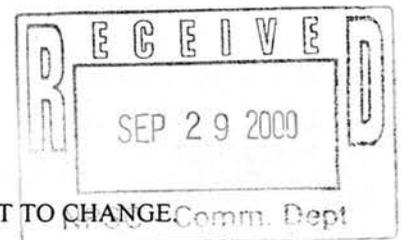

State of Nebraska
Notified: 5-9-2013

1. APPLICATION AND REFERENCE

1.3 SUBJECT INDEX (Cont'd)

SUBJECT	SECTION
Undertaking of the Company	
Carrier Common Line Access Service	3
Directory Assistance Service.....	9
General Regulations	2
Unlawful Use.....	2
Unmeasured Feature Group A and B Usage	3
Use.....	2
Voice Directory Assistance (Voice DA) Service	9
WATS Access Lines	3

(M) Material moved to Page 16.

1. APPLICATION AND REFERENCE

1.4 CATALOG FORMAT

1.4.1 LOCATION OF MATERIAL

- A. Section 1 provides the following for all of the sections in this Catalog:
- Subject Index - an alphabetical listing to find the desired section.
 - Table of Contents - A numerical listing to find the desired section and page.
- B. Each individual section in the Catalog provides a Subject Index for the material located within that section.
- C. Obsolete Service Offerings

Obsolete service offerings are identified in the Catalog by adding 100 to the current section number, i.e., obsolete items from Section 4, Coin Services, would be found in Section 104, Obsolete Coin Services. This section is then filed behind Section 4.

1.4.2 OUTLINE STRUCTURE

This document uses nine levels of indentations referred to as Tariff Information Management (TIM) Codes, as outlined below:

LEVEL	APPLICATION	EXAMPLE
1	Section Heading	1. APPLICATION AND REFERENCE
2	Sub Heading	1.4 CATALOG FORMAT
3	Sub Heading	1.4.1 LOCATION OF MATERIAL
4	Sub Heading/Text	A. Text
5	Sub Heading/Text	1. Text
6	Sub Heading/Text	a. Text
7	Sub Heading/Text	(1) Text
8	Sub Heading/Text	(a) Text
9	Footnotes	[1] Text

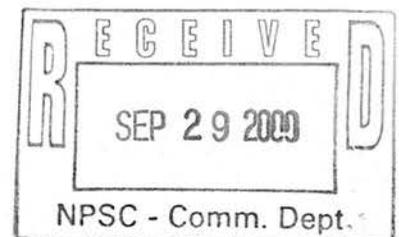

Qwest Corporation d/b/a CenturyLink QC
Access Service
Catalog

(C)

SECTION 1
Page 23
Release 2
Effective: 03-31-2017

State of Nebraska
Notified: 03-20-2017

1. APPLICATION AND REFERENCE

1.4 CATALOG FORMAT (Cont'd)

1.4.3 RATE TABLES

Within rate tables, four types of entries are allowed:

- Rate Amount

The rate amount indicates the dollar value associated with the service.

- A dash "-"

The dash indicates that there is no rate for the service or that a rate amount is not applicable under the specific column header.

- A footnote designator "[1]"

The footnote designator indicates that further information is contained in a footnote.

- ICB

The acronym "ICB" indicates that the product/service is rated on an individual case basis.

1.4.4 RESERVED FOR FUTURE USE

(T)

(D)

(D)

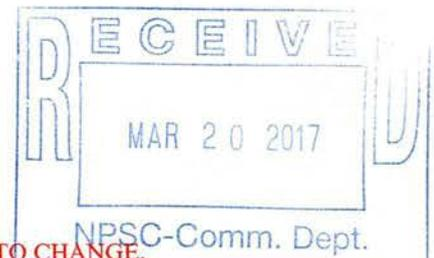

Qwest Corporation
Access Service
Catalog

SECTION 1

Page 24

Release 1

State of Nebraska
Notified: 9-29-2000

Effective: 9-29-2000

1. APPLICATION AND REFERENCE

1.5 EXPLANATION OF CHANGE SYMBOLS

SYMBOL	EXPLANATION
(C)	To signify changed term or condition
(D)	To signify discontinued material
(I)	To signify rate increase
(M)	To signify material moved from or to another part of the Catalog with no change, unless there is another change symbol present
(N)	To signify new material
(R)	To signify rate reduction
(T)	To signify a change in text but no change in term or condition

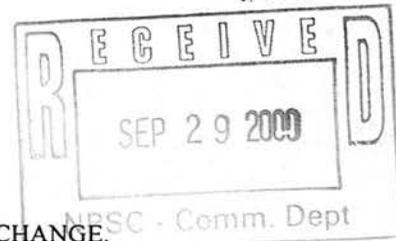

Qwest Corporation
Access Service
Catalog

SECTION 1
Page 25
Release 1

State of Nebraska
Notified: 9-29-2000

Effective: 9-29-2000

1. APPLICATION AND REFERENCE

1.6 EXPLANATION OF ABBREVIATIONS

800 DB	- 800 Data Base
ABD	- Average Business Day
ac	- Alternating current
ACAT	- Additional Cooperative Acceptance Testing
A/M	- Attempts per Message Ratio
AML	- Actual Measured Loss
ANI	- Automatic Number Identification
APP	- Application Date
AT	- Access Tandem
ATP	- Access Transport Parameter
AT&T	- American Telephone and Telegraph Company
ATTP	- Access Tandem Trunk Port
B8ZS	- Bipolar Eight Zero Substitution
BD	- Business Day
BHMC	- Busy Hour Minutes of Capacity
BP	- Billing Percentage
CAROT	- Centralized Automatic Reporting on Trunks
CCC	- Clear Channel Capability
CCSAC	- Common Channel Signaling Access Capability
CCSN	- Common Channel Signaling Network
CFA	- Circuit Facility Assignment
CI	- Channel Interface
CIC	- Carrier Identification Code
CMRS	- Commercial Mobile Radio Service
CN	- Charge Number
CO	- Central Office
CP	- Customer's Premises
CPE	- Customer Provided Equipment
CPN	- Calling Party Number
CSACC	- Customer Service Administration Control Center
CSP	- Carrier Selection Parameter
CST	- Cooperative Scheduled Testing
DA	- Directory Assistance
dB	- Decibel
dBm	- Decibel Milliwatt
dBm0	- Decibel Reference to One Milliwatt Relative to Zero Level
dBm	- Decibel Reference Noise
dBnc	- Decibel Reference Noise C-Message Weighting
dBnc0	- Decibel Reference Noise C-Message Weighted 0

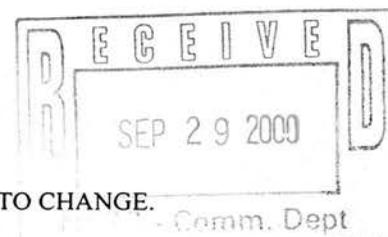

Qwest Corporation d/b/a CenturyLink QC
Access Service
Catalog

(C)

SECTION 1
Page 26
Release 5
Effective: 03-31-2017

State of Nebraska
Notified: 03-20-2017

1. APPLICATION AND REFERENCE

1.6 EXPLANATION OF ABBREVIATIONS (Cont'd)

- dBv - Decibel(s) relative to 1 volt (reference)
- dBvL - Decibel(s) relating to 1 volt (reference)
- dc - Direct current
- DD - Service Date
- DLR - Design Layout Report
- DLRD - Design Layout Report Date
- DLT - Direct Link Transport
- DTMF - Dual Tone Multifrequency
- DTT - Direct-Trunked Transport

- EDD - Envelope Delay Distortion
- EF - Entrance Facility
- EI - Expanded Interconnection
- EICT - Expanded Interconnection Channel Termination
- ELEPL - Equal Level Echo Path Loss
- EML - Expected Measured Loss
- EO - End Office
- EOSP - End Office Shared Port
- EPL - Echo Path Loss
- ERL - Echo Return Loss
- ESS - Electronic Switching System
- EXM - Exit Message
- f - Frequency
- F.C.C. - Federal Communications Commission

- FX - Foreign Exchange
- Hz - Hertz
- IAM - Initial Address Message
- IC - Interexchange Carrier
- ICB - Individual Case Basis
- ICL - Inserted Connection Loss
- ISUP - Integrated Services Digital Network User Part
- kbps - Kilobits per second
- kHz - Kilohertz
- LATA - Local Access and Transport Area
- LOF - Letter on File
- LPIC - Local Primary Interexchange Carrier
- LS - Local Switching

(D)

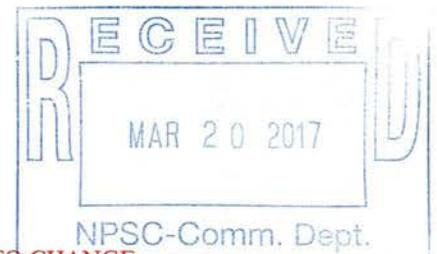

Qwest Corporation
Access Service
Catalog

SECTION 1

Page 27

Release 4

State of Nebraska
Notified: 12-30-2011

Effective: 1-11-2012

1. APPLICATION AND REFERENCE

1.6 EXPLANATION OF ABBREVIATIONS (Cont'd)

Ma	-	Milliamperes	
Mbps	-	Megabits per second	
MECAB	-	Multiple Exchange Carrier Access Billing	
MECOD	-	Multiple Exchange Carrier Ordering and Design	
MF	-	Multifrequency	
MHz	-	Megahertz	
MLD	-	Managed Long Distance	
MOU	-	Minutes of Use	
MPTS	-	Multiple POTS Tandem Sectorization	
MTS	-	Message Telecommunications Service(s)	
MTSO	-	Mobile Telephone Switching Office	
MTS/WATS	-	Message Telecommunications Service and/or Wide Area Telecommunications Service	
MUX	-	Multiplexing	
NANP	-	North American Numbering Plan	
NPA	-	Numbering Plan Area	
NTS	-	Non-Traffic Sensitive	
NXX	-	Three-Digit Central Office Code	
ONAL	-	Off Network Access Line	
OTPL	-	Zero Transmission Level Point	
PAL	-	Public Access Line	
PBX	-	Private Branch Exchange	
PCM	-	Pulse Code Modulation	
PDR	-	Percent Direct Routed	
PIC	-	Primary Interexchange Carrier	
PIU	-	Percent Interstate Use	
PLTS	-	Private Line Transport Service	
POM	-	Percent Other Messages	
POT	-	Point of Termination	
POTS	-	Plain Old Telephone Service	
PSP	-	Payphone Service Provider	
PSTN	-	Public Switched Telephone Network	(N)
PTD	-	Plant Test Date	
PVU	-	Percent VoIP Usage	(N)
RESP ORG	-	Responsible Organization	
Rms	-	Root-mean-square	
RSM	-	Remote Switching Modules	
RSS	-	Remote Switching Systems	

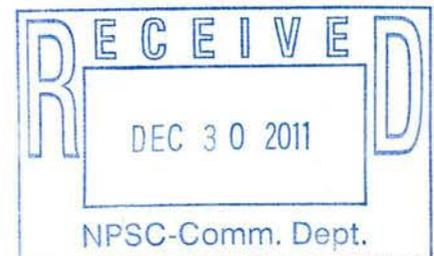

Qwest Corporation d/b/a CenturyLink QC
Access Service
Catalog

(C)

SECTION 1
Page 28
Release 4

State of Nebraska
Notified: 03-20-2017

Effective: 03-31-2017

1. APPLICATION AND REFERENCE

1.6 EXPLANATION OF ABBREVIATIONS (Cont'd)

- SCP - Service Control Point
- SMS/800 - Service Management System/800
- SP - Signal Point
- SPOI - Signaling Point of Interface
- SRL - Singing Return Loss
- SSN - Switched Service Network
- SSP - Service Switching Point
- SS7 - Signaling System 7
- STP - Signal Transfer Point
- SWC - Serving Wire Center
- TCAP - Transaction Capabilities Application Part
- TES - Telephone Exchange Service(s)
- TLP - Transmission Level Point
- TSP - Telecommunications Service Priority
- TSPS - Traffic Service Position System
- TST - Tandem-Switched Transport

- VG - Voice Grade
- V & H - Vertical & Horizontal
- VoIP - Voice over Internet Protocol
- WATS - Wide Area Telecommunications Service(s)

(D)



NOTICE

THE INFORMATION CONTAINED IN THIS DOCUMENT IS SUBJECT TO CHANGE.

1. APPLICATION AND REFERENCE

1.7 TRADEMARKS, SERVICE MARKS AND TRADE NAMES

Trade names, trademarks and/or service marks which may be used for services offered in this Catalog are owned by CenturyLink, Inc. or a subsidiary of CenturyLink, Inc. and are used by the Company with express permission. Trademark and service mark designations will not be listed hereafter in the Catalog. However, the laws regarding trademarks and service marks are applicable.

Trade names, trademarks and service marks that are owned by CenturyLink, Inc. or subsidiary of CenturyLink, Inc. cannot be used by another party without authorization.

CENTURYLINK
CENTURYLINKTM
CENTURYLINKSM

(D)
(N)

(N)

1.8 REFERENCE TO OTHER CATALOGS

Whenever reference is made in this Catalog to other catalogs of the Company, the reference is to the documents in force as of the effective date of this Catalog, and to amendments thereto and successive issues thereof.

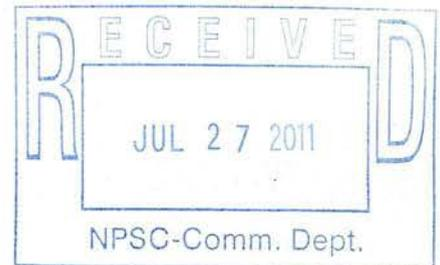

NOTICE

THE INFORMATION CONTAINED IN THIS DOCUMENT IS SUBJECT TO CHANGE.
NE2011-018

Qwest Corporation
Access Service
Catalog

SECTION 1

Page 30

Release 1

State of Nebraska
Notified: 9-29-2000

Effective: 9-29-2000

1. APPLICATION AND REFERENCE

1.9 REFERENCE TO TECHNICAL PUBLICATIONS

- A. All service(s) offered in this document must conform to the transmission specification standards contained in this document or in the following Technical References.
- B. The following publications may be obtained from Telcordia, Customer Service, 8 Corporate Place, PYA-3A184, Piscataway, NJ 08854-4196:

TITLE	PUBLICATION NUMBER
LATA Switching Systems Generic Requirements (LSSGR)	FR-64
Operator Services Systems Generic Requirements (OSSGR)	FR-271
Transport Systems Generic Requirements (TSGR)	FR-NWT-000440
Ordering and Billing Forum-Multiple Exchange Carrier Access Billing (MECAB)	SR-ILB-000983
Industry Support Interface (ISI): General Overview	SR-STS-000284
Ordering and Billing Forum-Multiple Exchange Carrier Ordering and Design Guidelines (MECOD)	SR-TAP-000984
Trunk Traffic Engineering Concepts And Applications	SR-TAP-000191
Telecommunications Transmission Engineering Textbook-Volume 3: Network and Services, Third Edition	ST-TEC-000053

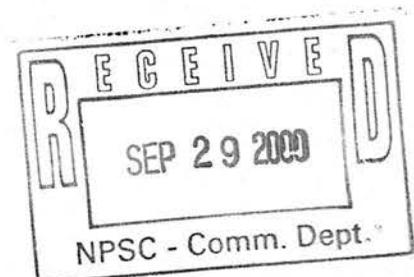

NOTICE

THE INFORMATION CONTAINED IN THIS DOCUMENT IS SUBJECT TO CHANGE.
NE2000-054

Qwest Corporation
Access Service
Catalog

SECTION 1
Page 31
Release 1

State of Nebraska
Notified: 9-29-2000

Effective: 9-29-2000

1. APPLICATION AND REFERENCE

1.9 REFERENCE TO TECHNICAL PUBLICATIONS

B. (Cont'd)

TITLE	PUBLICATION NUMBER
Estimated Transmission Performance of Switched Access Service Feature Group-D	TR-NPL-000002
Compatibility Information for Feature Group B Switched Access Service	TR-NPL-000175
Compatibility Information for Feature Group D Switched Access Service	TR-NPL-000258
Voice Grade Switched Access Service - Transmission Parameter Limits and Interface Combinations	GR-334-CORE
Switching System Requirements for Interexchange Carrier Interconnection Using the Integrated Services Digital Network User Part (ISDNUP)	GR-394-CORE
Network Transmission Interface and Performance Specification Supporting Integrated Services Digital Network (ISDN)	TR-NWT-000938
Common Channel Signaling (CCS) Network Interface Specification	GR-905-CORE
Common Channel Signaling (CCS) Network Interface Specification Supporting Alternate Billing Services (ABS)	GR-954-CORE

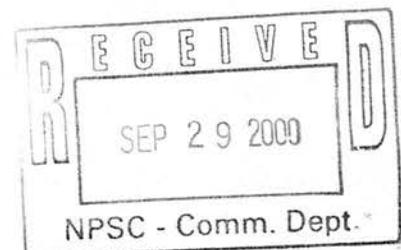

Qwest Corporation
Access Service
Catalog

SECTION 1
Page 32
Release 1

State of Nebraska
Notified: 9-29-2000

Effective: 9-29-2000

1. APPLICATION AND REFERENCE

1.9 REFERENCE TO TECHNICAL PUBLICATIONS

B. (Cont'd)

TITLE	PUBLICATION NUMBER
Dual-Tone Multifrequency Receiver Generic Requirements for End-to-End Signaling Over Tandem-Switched Voice Links	TR-TSY-000181
Network Interface Description for ISDN Customer Access	TR-TSY-000776
SONET Digital Switch Trunk Interface Criteria	TR-TSY-000782

C. The following Company technical publications may be obtained from Faison Office Products Company, Customer Services, 3251 Revere Street, Suite 200, Aurora, CO 80011:

TITLE	PUBLICATION NUMBER
Qwest Corporation DS3 Service	77324
SWITCHNET 56 Switched 56 kbit/s Digital Service	77329
Qwest Corporation Common Channel Signaling Interconnections	77342
1.544 Mbit/s Channel Interfaces Technical Specifications for Network Channel Interface Codes Describing Electrical Interfaces at Customer Premises and at Qwest Corporation, Central Offices	77375, Issue D
Physical and Virtual Collocation and Associated DS1 and DS3 Expanded Interconnection Channel Terminations	77201, Issue D

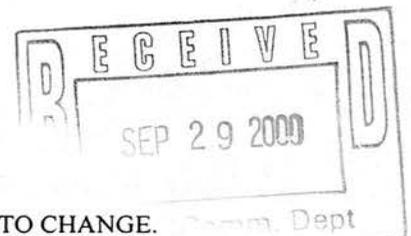

Qwest Corporation
Access Service
Catalog

SECTION 1
Page 33
Release 1

State of Nebraska
Notified: 9-29-2000

Effective: 9-29-2000

1. APPLICATION AND REFERENCE

1.9 REFERENCE TO TECHNICAL PUBLICATIONS (Cont'd)

- D. The following publication may be obtained from the Telcordia Number Administration Service Center (NASC), 920 West Mount Pleasant Avenue, Livingston, NJ 07039-0486:

TITLE

Guidelines for 800 Data Base

- E. The following publication may be obtained from Telcordia, Customer Service, 8 Corporate Place, PYA-3A184, Piscataway, NJ 08854-4196:

TITLE

SMS/800 User Guide: 800 Service Management

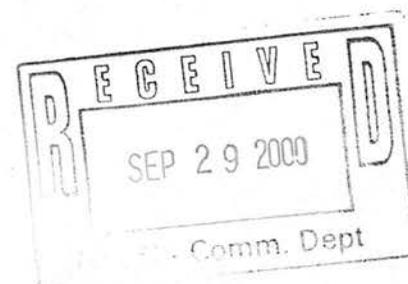

NOTICE

THE INFORMATION CONTAINED IN THIS DOCUMENT IS SUBJECT TO CHANGE.
NE2000-054

Qwest Corporation
Access Service
Catalog

State of Nebraska
Notified: 6-1-2016

SECTION 1
Page 34
Release 2
Effective: 7-1-2016

1. APPLICATION AND REFERENCE

1.10 REFERENCE TO OTHER PUBLICATIONS

- A. The following publications are available for inspection in the Public Reference room of the Tariff Division at the main building of the Federal Communications Commission located at 1919 M Street N.W., Washington, D.C., and may be obtained from the Federal Communications Commission's commercial contractor:

TITLE

CC Docket No. 83-1145, Phase I
Memorandum Opinion and Order
(Including Appendices A, B, and C)
Adopted: May 31, 1985
Released: June 12, 1985

CC Docket No. 85-145
Memorandum Opinion and Order
Adopted: April 16, 1985

National Exchange Carrier Association, Inc.
Tariff F.C.C. No. 4

CenturyLink Operating Companies
Tariff F.C.C. No. 11

CenturyLink Operating Compaies
Tariff F.C.C. No. 12

(T)
—
(T)

- B. The following publication may be obtained by contacting the Company Account Representative:

TITLE

Qwest Corporation Service Interval Guide
Issued: November, 1988

Qwest Corporation Tandem Sectorization Guide
Issued: September, 1990

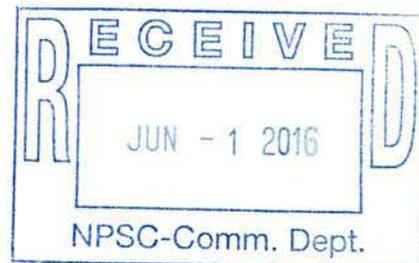

NOTICE

THE INFORMATION CONTAINED IN THIS DOCUMENT IS SUBJECT TO CHANGE.
NE2016-001

1. APPLICATION AND REFERENCE

1.10 REFERENCE TO OTHER PUBLICATIONS (Cont'd)

- C. The following publications may be obtained through the Government Printing Office, Superintendent of Documents, Document Control Branch, 941 N. Capitol St. N.E., Washington, D.C. 20401:

TITLE

Telecommunications Service Priority (TSP) System for National Security Emergency Preparedness (NSEP) Service Vendor Handbook, National Communications System (NCS) H 3-1-2
Issued: July, 1990

Telecommunications Service Priority (TSP) System for National Security Emergency Preparedness (NSEP) Service User Manual, National Communications System (NCS) M 3-1-1
Issued: July, 1990

Code of Federal Regulations, Title 47

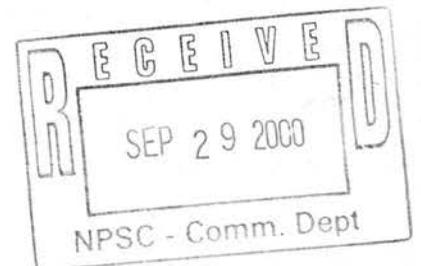

Qwest Corporation
Access Service
Catalog

SECTION 2
Index Page 1
Release 2
Effective: 1-11-2012

State of Nebraska
Notified: 12-30-2011

2. GENERAL REGULATIONS

SUBJECT	PAGE	
Availability for Testing	11	
Balance	11	
Cancellation of an Order for Service.....	36	
Changes and Substitutions	5	
Claims and Demands for Damages	12	
Connections.....	51	
Coordination With Respect to Network Contingencies		
Obligations of the Customer.....	13	
Undertaking of the Company	8	
Credit Allowance for Service Interruptions	36	
Damages	10	
Definitions.....	52	
Design of Customer Service.....	11	
Determination of Interstate Charges for Mixed Interstate and Intrastate Access Service	30	
Equipment Space and Power	10	
General	51	
Identification and Rating of VoIP-PSTN Traffic	28.1	(N)
Installation and Termination of Services	5	
Interference or Impairment.....	9	
Jurisdictional Report Requirements	13	
Late Payment Penalty	33	
Liability	3	
Limitation of Use of Metallic Facilities	7	
Limitations.....	1	
Maintaining Services.....	5	
Minimum Periods.....	36	
Notification of Service-Affecting Activities	8	

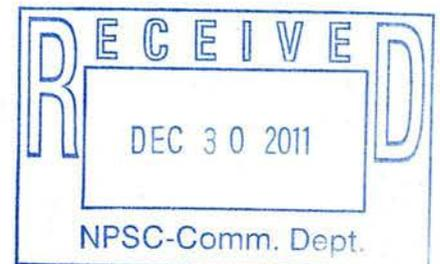

Qwest Corporation
Access Service
Catalog

SECTION 2
Index Page 2
Release 1

State of Nebraska
Notified: 9-29-2000

Effective: 9-29-2000

2. GENERAL REGULATIONS

SUBJECT	PAGE
Obligations of the Customer	10
Ordering, Rating and Billing of Access Services Where More Than One Exchange Company is Involved	40
Ordering, Rating and Billing of Switched Access Provided in Conjunction with a Commercial Mobile Radio Service Provider.....	50
Ownership of Facilities and Theft.....	10
Payment Arrangements and Credit Allowances	32
Payment Due Date	33
Payment of Rates, Charges and Deposits	32
Provision and Ownership of Telephone Numbers	8
Provision of Services	4
Reestablishment of Service Following Fire, Flood or Other Occurrence	39
References to the Company	11
Refusal and Discontinuance of Services	6
Scope	1
Shared Use	80
Title or Ownership Rights	39
Undertaking of the Company.....	1
Unlawful Use	9
Use	9

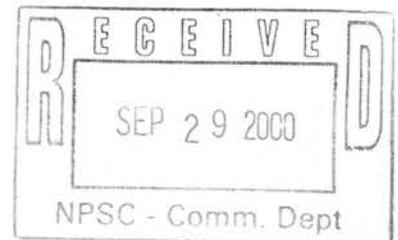

Qwest Corporation
Access Service
Catalog

SECTION 2

Page 1

Release 1

Effective: 9-29-2000

State of Nebraska
Notified: 9-29-2000

2. GENERAL REGULATIONS

2.1 UNDERTAKING OF THE COMPANY

2.1.1 SCOPE

- A. The Company does not undertake to transmit messages under this Catalog.
- B. The Company shall be responsible only for the installation, operation and maintenance of the services which it provides.
- C. The Company will, for maintenance purposes, test its services only to the extent necessary to detect and/or clear troubles.
- D. Services are provided 24 hours daily, 7 days per week, except as set forth in other applicable sections of this Catalog.
- E. The Company does not warrant that its facilities and services meet standards other than those set forth in this Catalog.

2.1.2 LIMITATIONS

- A. The customer may not assign or transfer the use of services provided under this Catalog; however, where there is no interruption of use or relocation of the services, such assignment or transfer may be made to:
 - 1. Another customer, whether an individual, partnership, association or corporation, provided the assignee or transferee assumes all outstanding indebtedness for such services, and the unexpired portion of the minimum period and the termination liability applicable to such services, if any; or
 - 2. A court appointed receiver, trustee or other person acting pursuant to law in bankruptcy, receivership, reorganization, insolvency, liquidation or other similar proceedings, provided the assignee or transferee assumes the unexpired portion of the minimum period and the termination liability applicable to such services, if any.

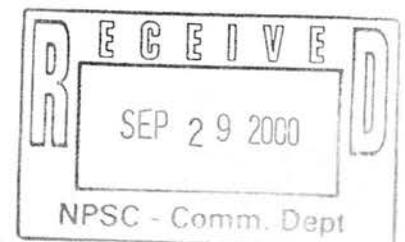

NOTICE

THE INFORMATION CONTAINED IN THIS DOCUMENT IS SUBJECT TO CHANGE.
NE2000-054

Qwest Corporation
Access Service
Catalog

SECTION 2

Page 2

Release 1

Effective: 9-29-2000

State of Nebraska
Notified: 9-29-2000

2. GENERAL REGULATIONS

2.1 UNDERTAKING OF THE COMPANY

2.1.2 LIMITATIONS

A. (Cont'd)

In all cases of assignment or transfer, the written acknowledgment of the Company is required prior to such assignment or transfer which acknowledgment shall be made within 15 days from the receipt of notification. All regulations and conditions contained in this Catalog shall apply to such assignee or transferee.

The assignment or transfer of services does not relieve or discharge the assignor or transferor from remaining jointly or severally liable with the assignee or transferee for any obligations existing at the time of the assignment or transfer.

The assignor or transferor and the assignee or transferee will be required to sign a Transfer of Use Agreement assuming all outstanding indebtedness as set forth in 2.1.2.A.1., preceding. In all cases where there is no interruption of use or relocation of the services (i.e., change in Carrier Identification Code (CIC) or any other technical and or physical change to the service), administrative changes will be made without charge(s).

- B. The installation and restoration of services shall be subject to the terms and conditions set forth in Section 4 of the Private Line Transport Services Catalog concerning the Telecommunications Service Priority (TSP) System.
- C. Subject to compliance with the rules mentioned in B., preceding, the services offered herein will be provided to customers on a first-come, first-served basis.

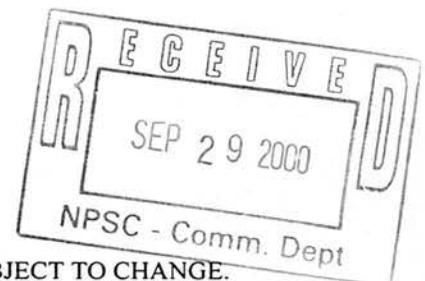

NOTICE

THE INFORMATION CONTAINED IN THIS DOCUMENT IS SUBJECT TO CHANGE.
NE2000-054

Qwest Corporation
Access Service
Catalog

SECTION 2

Page 3

Release 1

State of Nebraska
Notified: 9-29-2000

Effective: 9-29-2000

2. GENERAL REGULATIONS

2.1 UNDERTAKING OF THE COMPANY (Cont'd)

2.1.3 LIABILITY

A. General

1. The Company shall not be liable for any act or omission of any other carrier or customer providing a portion of a service, nor shall the Company for its own act or omission hold liable any other carrier or customer providing a portion of a service.
2. The Company shall be indemnified, defended and held harmless by the end user or IC against any claim, loss or damage arising from the end user's or IC's use of services offered under this Catalog, involving:
 - a. Claims for libel, slander, invasion of privacy, or infringement of copyright arising from the end user's or IC's own communications;
 - b. Claims for patent infringement arising from the end user's acts combining or using the service furnished by the Company in connection with facilities or equipment furnished by the end user or IC or;
 - c. All other claims arising out of any act or omission of the end user in the course of using services provided pursuant to this Catalog.
3. No license under patents (other than the limited license to use) is granted by the Company or shall be implied or arise by estoppel, with respect to any service offered under this Catalog. The Company will defend the customer against claims of patent infringement arising solely from the use by the customer of services offered under this Catalog and will indemnify such customer for any damages awarded based solely on such claims.
4. The Company's failure to provide or maintain services under this Catalog shall be excused by labor difficulties, governmental orders, civil commotions, criminal actions taken against the Company, acts of God and other circumstances beyond the Company's reasonable control, subject to the Credit Allowance for a Service Interruption as set forth in 2.4.4, following.

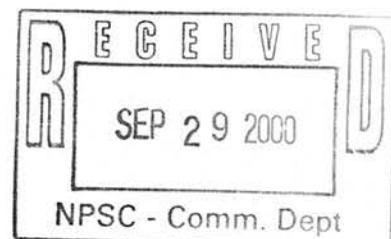

NOTICE

THE INFORMATION CONTAINED IN THIS DOCUMENT IS SUBJECT TO CHANGE.
NE2000-054

Qwest Corporation
Access Service
Catalog

SECTION 2

Page 4

Release 1

Effective: 9-29-2000

State of Nebraska
Notified: 9-29-2000

2. GENERAL REGULATIONS

2.1 UNDERTAKING OF THE COMPANY

2.1.3 LIABILITY

A. General (Cont'd)

5. The Company does not guarantee or make any warranty with respect to its services when used in an explosive atmosphere. The Company shall be indemnified, defended and held harmless by the customer from any and all claims by any person relating to such customer's use of services so provided.

B. Liability

1. The Company's liability, if any, for its willful misconduct is not limited by this Catalog. With respect to any other claim or suit, by a customer or by any others, for damages associated with the installation, provision, preemption, termination, maintenance, repair or restoration of service, including presubscription, and subject to the provisions of A., preceding, the Company's liability, shall not exceed an amount equal to the proportionate charge for the service for the period during which the service was affected.

This liability for damages shall be in addition to any amounts that may otherwise be due the customer under this Catalog as a Credit Allowance for a Service Interruption.

2. The Company is not liable for damages to the customer's premises resulting from the furnishing of a service, including the installation and removal of equipment and associated wiring, unless the damage is caused by the Company's negligence.

2.1.4 PROVISION OF SERVICES

The Company, to the extent that such services are or can be made available with reasonable effort, and after provision has been made for the Company's telephone exchange services, will provide to the customer upon reasonable notice services offered in other applicable sections of this Catalog at rates and charges specified therein.

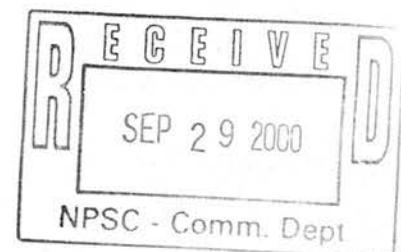

NOTICE

THE INFORMATION CONTAINED IN THIS DOCUMENT IS SUBJECT TO CHANGE.
NE2000-054

Qwest Corporation
Access Service
Catalog

SECTION 2

Page 5

Release 1

State of Nebraska
Notified: 9-29-2000

Effective: 9-29-2000

2. GENERAL REGULATIONS

2.1 UNDERTAKING OF THE COMPANY (Cont'd)

2.1.5 INSTALLATION AND TERMINATION OF SERVICES

A. All Services Except Expanded Interconnection Service

The services provided under this Catalog (a) will include any entrance cable or drop wiring to that point where provision is made for termination of the Company's outside distribution network facilities at a suitable location at a customer-designated premises and (b) will be installed by the Company to such Point of Termination (POT). Access Service has only one POT per customer premises. Any additional terminations beyond such POT are the sole responsibility of the customer.

B. Expanded Interconnection (EI) Service

The Expanded Interconnection Service provided for under this Catalog will include the appropriation, installation and termination of equipment in accordance with the regulations as set forth in Section 21, following.

2.1.6 MAINTAINING SERVICES

The services provided under this Catalog shall be maintained by the Company except for interconnector provided and owned fiber optic facilities at the point of interconnection for EI Service. The customer or others may not rearrange, move, disconnect, remove or attempt to repair any facilities provided by the Company or contained in a Company-owned facility housing (e.g., above ground cabinets, underground utility vaults, utility hole, hand hole, etc.), except with prior written consent and presence of a Company-designated inspector.

2.1.7 CHANGES AND SUBSTITUTIONS

Except as provided for equipment and systems subject to F.C.C. Part 68 regulations at 47 C.F.R. Section 68.110 (b), the Company may, where such action is reasonably required in the operation of its business, (a) substitute, change or rearrange any facilities used in providing service pursuant to the rules and regulations governing this Catalog, including but not limited to, (1) substitution of different metallic facilities, (2) substitution of carrier or derived facilities for metallic facilities used to provide other than metallic facilities and (3) substitution of metallic facilities for carrier or derived facilities used to provide other than metallic facilities, (b) change minimum protection criteria, (c) change operating or maintenance characteristics of facilities or (d) change operations or procedures of the Company.

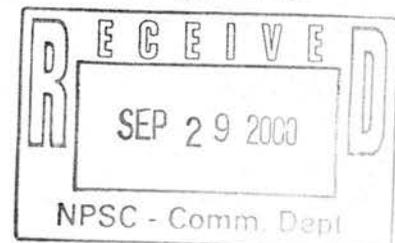

NOTICE

THE INFORMATION CONTAINED IN THIS DOCUMENT IS SUBJECT TO CHANGE.
NE2000-054

Qwest Corporation
Access Service
Catalog

SECTION 2
Page 6
Release 2
Effective: 4-12-2019

State of Nebraska
Notified: 4-02-2019

2. GENERAL REGULATIONS

2.1 UNDERTAKING OF THE COMPANY
2.1.7 CHANGES AND SUBSTITUTIONS (Cont'd)

In case of any such substitution, change or rearrangement, the transmission parameters will be within the range as set forth in Section 6, following. The Company shall not be responsible if any such substitution, change or rearrangement renders any customer furnished services obsolete or requires modification or alteration thereof or otherwise affects their use or performance. If such substitution, change or rearrangement materially affects the operating characteristics of the facility, the Company will provide reasonable notification to the customer in writing. Reasonable time will be allowed for any redesign and implementation required by the change in operating characteristics. The Company will work cooperatively with the customer to determine reasonable notification requirements.

It is expressly declared that metallic facilities are in continually decreasing supply and the Company is not obligated to continue to provide such facilities. Due to facility rearrangements, continued use of metallic facilities may be denied to existing customers with no obligation on the Company's part to pay customer equipment rearrangement costs. The Company will give the customer 90 days notification of this type of facility rearrangements. Metallic facilities are provided only where existing facilities and operating conditions permit.

2.1.8 REFUSAL AND DISCONTINUANCE OF SERVICES

- A. Unless the provisions of 2.2.1.B. or 2.5, following, apply, if a customer fails to comply with 2.1.6, preceding, or 2.2.2, 2.3.1, 2.3.4, 2.3.5, 2.4 or 13.3.7, following, including any payments to be made by it on the dates and times herein specified, the Company may, on thirty (30) days written notice (by mail or by email if the customer is billed electronically or consents to receiving electronic notification) to the person designated by that customer to receive such notices of noncompliance, refuse additional applications for service and/or refuse to complete any pending orders for service by the non-complying customer at any time thereafter.

(C)
(C)

If the Company does not refuse additional applications for service on the date specified in the thirty (30) days notice, and the customer's noncompliance continues, nothing contained herein shall preclude the Company's right to refuse additional applications for service to the non-complying customer without further notice.

Received

APR - 2 2019

NPSC Comm. Dept.

NOTICE

THE INFORMATION CONTAINED IN THIS DOCUMENT IS SUBJECT TO CHANGE.

NE2019-003

Qwest Corporation
Access Service
Catalog

SECTION 2
Page 7
Release 2
Effective: 4-12-2019

State of Nebraska
Notified: 4-02-2019

2. GENERAL REGULATIONS

2.1 UNDERTAKING OF THE COMPANY

2.1.8 REFUSAL AND DISCONTINUANCE OF SERVICES (Cont'd)

- B. Unless the provisions of 2.2.1.B. or 2.5, following, apply, if a customer fails to comply with 2.1.6, preceding, or 2.2.2, 2.3.1, 2.3.4, 2.3.5, 2.4 or 13.3.7, following, including any payments to be made by it on the dates and times herein specified, the Company may, on thirty (30) days written notice (by mail or by email if the customer is billed electronically or consents to receiving electronic notification) to the person designated by that customer to receive such notices of noncompliance, refuse additional applications for service and/or refuse to complete any pending orders for service by the noncomplying customer at any time thereafter. (C)

If the Company does not discontinue the provision of the services involved on the date specified in the thirty (30) days notice, and the customer's noncompliance continues, nothing contained herein shall preclude the Company's right to refuse additional applications for service to the noncomplying customer without further notice.

- C. When Access Service is provided by more than one Company, the Companies involved in providing the joint service may individually or collectively deny service, if technically feasible, to a customer for nonpayment. When the Company affected by the nonpayment is incapable of instituting a service denial without cooperation from the other joint provider(s), such other Company may request assistance in denying the jointly provided service. Service denial for such joint service will only include calls which originate or terminate within, or transit, the operating territory of the Company (Companies) initiating the service denial for nonpayment. The Company assisting in the service denial will notify the customer, with thirty (30) days written notice (by mail or by email if the customer is billed electronically or consents to receiving electronic notification), after receiving a written request from the affected Company. The tariff regulations of the end office Company shall apply for instituting service denial for a jointly provided service. (C)

2.1.9 LIMITATION OF USE OF METALLIC FACILITIES

Signals applied to a metallic facility shall conform to the limitations set forth in Technical Reference Publication AS No. 1. In the case of application of dc telegraph signaling systems, the customer shall be responsible, at its expense, for the provision of current limiting devices to protect the Company facilities from excessive current due to abnormal conditions and for the provision of noise mitigation networks when required to reduce excessive noise.

Received

APR - 2 2019

KPSC Comm. Dept.

NOTICE

THE INFORMATION CONTAINED IN THIS DOCUMENT IS SUBJECT TO CHANGE.

2. GENERAL REGULATIONS

2.1 UNDERTAKING OF THE COMPANY (Cont'd)

2.1.10 NOTIFICATION OF SERVICE-AFFECTING ACTIVITIES

The Company will provide the customer reasonable notification of service-affecting activities that may occur in normal operation of its business. Such activities may include, but are not limited to, equipment or facilities additions, removals or rearrangements, routine preventative maintenance and major switching machine change-out. Generally, such activities are not individual customer service specific, they affect many customer services. No specific advance notification period is applicable to all service activities. The Company will work cooperatively with the customer to determine reasonable notification requirements.

2.1.11 COORDINATION WITH RESPECT TO NETWORK CONTINGENCIES

The Company intends to work cooperatively with the customer to develop network contingency plans in order to maintain maximum network capability following natural or man-made disasters which affect telecommunications services.

2.1.12 PROVISION AND OWNERSHIP OF TELEPHONE NUMBERS

The Company reserves the reasonable right to assign, designate or change telephone numbers, any other call number designations associated with Access Services, or the Company serving central office prefixes associated with such numbers, when necessary in the conduct of its business. Should it become necessary to make a change in such number(s), the Company will furnish to the customer six (6) months notice, by Certified U.S. Mail, of the effective date and an explanation of the reason(s) for such change(s), beyond the nonexclusive limited right-to-use described in this Catalog.

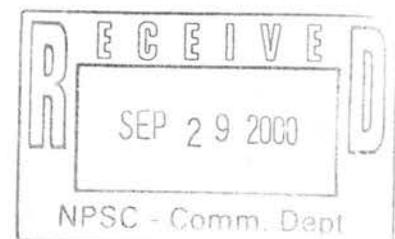

NOTICE

THE INFORMATION CONTAINED IN THIS DOCUMENT IS SUBJECT TO CHANGE.
NE2000-054

Qwest Corporation
Access Service
Catalog

SECTION 2

Page 9

Release 1

State of Nebraska
Notified: 9-29-2000

Effective: 9-29-2000

2. GENERAL REGULATIONS

2.2 USE

2.2.1 INTERFERENCE OR IMPAIRMENT AND UNLAWFUL USE

- A. The characteristics and methods of operation of any circuits, facilities or equipment provided by other than the Company and associated with the facilities utilized to provide services pursuant to the rules and regulations governing this Catalog shall not interfere with or impair service over any facilities of the Company, its affiliated companies, or its connecting and concurring carriers involved in its services, cause damage to their plant, impair the privacy of any communications carried over their facilities or create hazards to the employees of any of them or the public.
- B. Except as provided for equipment or systems subject to the F.C.C. Part 68 rules in 47 C.F.R. Section 68.108, if such characteristics or methods of operation are not in accordance with A., preceding, the Company will, where practicable, notify the customer that temporary discontinuance of the use of a service may be required; however, where prior notice is not practicable, nothing contained herein shall be deemed to preclude the Company's right to discontinue temporarily the use of a service if such action is reasonable under the circumstances. In case of such temporary discontinuance, the customer will be promptly notified and afforded the opportunity to correct the condition which gave rise to the temporary discontinuance. During such period of temporary discontinuance, Credit Allowance for Service Interruptions as set forth in 2.4.4.A. and B., following, is not applicable.
- C. The service provided under this Catalog shall not be used for an unlawful purpose.

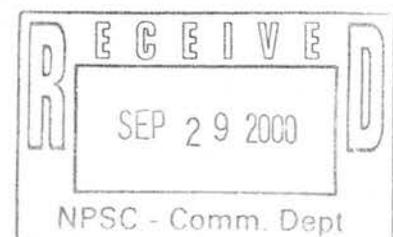

NOTICE

THE INFORMATION CONTAINED IN THIS DOCUMENT IS SUBJECT TO CHANGE.
NE2000-054

Qwest Corporation
Access Service
Catalog

SECTION 2

Page 10

Release 1

Effective: 9-29-2000

State of Nebraska
Notified: 9-29-2000

2. GENERAL REGULATIONS

2.3 OBLIGATIONS OF THE CUSTOMER

2.3.1 DAMAGES

The customer shall reimburse the Company for damages to the Company facilities for all services utilized to provide services under this Catalog caused by the negligence or willful act of the customer or resulting from the customer's improper use of the Company facilities, or due to malfunction of any facilities or equipment provided by other than the Company. Nothing in the foregoing provision shall be interpreted to hold one customer liable for another customer's actions. The Company will, upon reimbursement for damages, cooperate with the customer in prosecuting a claim against the person causing such damage, and the customer shall be subrogated to the right of recovery by the Company for the damages to the extent of such payment.

2.3.2 OWNERSHIP OF FACILITIES

Facilities utilized by the Company to provide service under the provisions of this Catalog shall remain the property of the Company. Such facilities shall be returned to the Company by the customer whenever requested, within a reasonable period following the request, in as good condition as reasonable wear will permit.

2.3.3 EQUIPMENT SPACE AND POWER

The customer shall furnish or arrange to have furnished to the Company, at no charge, equipment space and electrical power required by the Company to provide services under this Catalog at the points of termination of such services. The selection of ac or dc power shall be mutually agreed to by the customer and the Company. The customer shall also make necessary arrangements in order that the Company will have access to such spaces at reasonable times for installing, testing, inspecting, repairing or removing Company services.

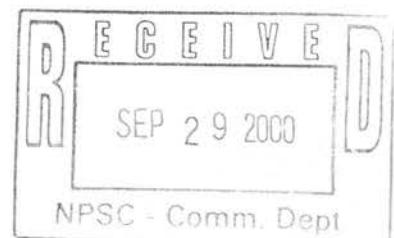

NOTICE

THE INFORMATION CONTAINED IN THIS DOCUMENT IS SUBJECT TO CHANGE.
NE2000-054

2. GENERAL REGULATIONS

2.3 OBLIGATIONS OF THE CUSTOMER (Cont'd)

2.3.4 AVAILABILITY FOR TESTING

The services provided pursuant to this Catalog shall be available to the Company at times mutually agreed upon in order to permit the Company to make tests and adjustments appropriate for maintaining the services in satisfactory operating condition. Such tests and adjustments shall be completed within a reasonable time. No credit will be allowed for any interruptions involved during such tests and adjustment.

2.3.5 BALANCE

All signals for transmission over the services provided under this Catalog shall be delivered by the customer balanced to ground except for ground start.

2.3.6 DESIGN OF CUSTOMER SERVICES

Subject to the provisions of 2.1.7, preceding, the customer shall be solely responsible, at its own expense, for the overall design of its services and for any redesigning or rearrangement of its services which may be required because of changes in facilities, operations or procedures of the Company, minimum protection criteria or operating or maintenance characteristics of the facilities.

2.3.7 REFERENCES TO THE COMPANY

The customer may advise end users that certain services are provided by the Company in connection with the service the customer furnishes to end users; however, the customer shall not represent that the Company jointly participates in the customer's services.

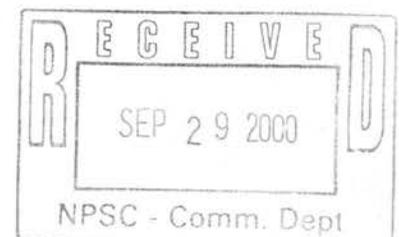

NOTICE

THE INFORMATION CONTAINED IN THIS DOCUMENT IS SUBJECT TO CHANGE.
NE2000-054

Qwest Corporation
Access Service
Catalog

SECTION 2

Page 12

Release 1

Effective: 9-29-2000

State of Nebraska
Notified: 9-29-2000

2. GENERAL REGULATIONS

2.3 OBLIGATIONS OF THE CUSTOMER (Cont'd)

2.3.8 CLAIMS AND DEMANDS FOR DAMAGES

- A. With respect to claims of patent infringement made by third persons, the customer shall defend, indemnify, protect and save harmless the Company from and against all claims arising out of the combining with, or use in connection with, the services provided under this Catalog, any circuit, apparatus, system or method provided by the customer.
- B. The customer shall defend, indemnify and save harmless the Company from and against any suits, claims, losses, damages, including punitive damages, attorney fees and court costs by third persons arising out of the construction, installation, operation, maintenance, or removal of the customer's circuits, facilities, or equipment connected to the Company's services provided under this Catalog. Included, without limitation, are Workmen's Compensation claims, actions for infringement of copyright and/or unauthorized use of program material. Also included without limitation are libel and slander actions based on the content of communications transmitted over the customer's circuits, facilities or equipment. In addition, proceedings to recover taxes, fines, or penalties for failure of the customer to obtain or maintain in effect any necessary certificates, permits, licenses, or other authority to acquire or operate the services provided under this Catalog shall be included in the indemnification. However, the foregoing indemnification shall not apply to suits, claims, and demands to recover damages for damage to property, death, or personal injury unless such suits, claims or demands are based on the tortious conduct of the customer, its officers, agents or employees.
- C. The customer shall defend, indemnify, and save harmless the Company from and against any suits, claims, losses or damages, including punitive damages, attorney fees and court costs by the customer or third parties arising out of any act or omission of the customer in the course of using services provided under this Catalog.

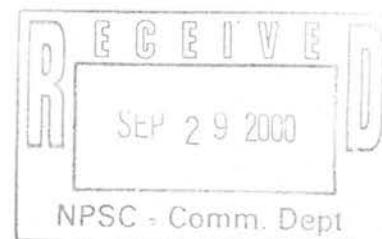

NOTICE

THE INFORMATION CONTAINED IN THIS DOCUMENT IS SUBJECT TO CHANGE.
NE2000-054

2. GENERAL REGULATIONS

2.3 OBLIGATIONS OF THE CUSTOMER (Cont'd)

2.3.9 COORDINATION WITH RESPECT TO NETWORK CONTINGENCIES

The customer shall, in cooperation with the Company, coordinate in planning the actions to be taken to maintain maximum network capability following natural or man-made disasters which affect telecommunications services.

2.3.10 JURISDICTIONAL REPORT REQUIREMENTS

A. Jurisdictional Determinant

Pursuant to Federal Communications Commission order FCC 85-145 adopted April 16, 1985, interstate usage is to be developed as though every call that enters a customer network at a point within the same state as that in which the called station (as designated by the called station number) is situated is an intrastate communication and every call for which the point of entry is in a state other than that where the called station (as designated by the called station number) is situated is an interstate communication.

To determine the jurisdiction of a call, the Company compares the originating number information with the terminating number information. Traffic without sufficient call detail shall be that traffic for which the originating number information lacks a valid Charge Party Number (ChPN) or Calling Party Number (CPN).

(N)
|
(N)

For purposes of CCSAC ISUP Call Set-up requests, Percent Other Messages (POM) shall be established by dividing the customer CCSAC ISUP Call Set-up requests (originating and terminating) associated with local, EAS, intraMTA, the Local Exchange Company portion of jointly provided Switched Access and Company originated toll by the total number of CCSAC ISUP Call Set-up requests (originating and terminating) and expressing the result as a percentage in a whole number.

When mixed interstate and intrastate Access Service is provided on the same Access Service transmission path, all charges between interstate and intrastate are prorated as set forth in 2.3.12, following.

(M) Material moved to Page 13.1.

NOTICE

THE INFORMATION CONTAINED IN THIS DOCUMENT IS SUBJECT TO CHANGE.
NE2008-015 Replacement 1



2. GENERAL REGULATIONS

2.3 OBLIGATIONS OF THE CUSTOMER
2.3.10 JURISDICTIONAL REPORT REQUIREMENTS

A. Jurisdictional Determinant(Cont'd)

A floor of 7% will be set for a switched access customer's Feature Group D terminating access minutes when they are lacking originating number information needed to determine jurisdiction. The 7% floor will be applied as follows:

- When the percentage of terminating traffic without sufficient call detail to determine jurisdiction does not exceed the 7% floor, the Company will apply the PIU factor as set forth in B.2.c, following or
- When the percentage of terminating traffic without sufficient call detail to determine jurisdiction exceeds the 7% floor, the Company will assess rates from the state jurisdiction on all minutes exceeding the 7% floor.

B. Jurisdictional Requirements

The customer must indicate a projected Percent of Interstate Use (PIU) factor in a whole number (i.e., a number 0 - 100) when ordering Switched Access Service in a LATA, including EF and DTT Facilities. When a customer-provided PIU factor is required and the customer has previously submitted a jurisdictional report (i.e., Letter on File [LOF]) as set forth in C., following, the LOF PIU factor is required on each Access Service Request (ASR).

For CCSAC, customers who are third party signaling providers must develop their jurisdictional factors based upon the weighted average of the jurisdictional factors of their customers.

(N)

(N)

(M)

(M)

(M) Material moved from Page 13.

NOTICE

THE INFORMATION CONTAINED IN THIS DOCUMENT IS SUBJECT TO CHANGE.
NE2008-015 Replacement 1



Qwest Corporation
Access Service
Catalog

SECTION 2
Page 14
Release 2
Effective: 7-1-2016

State of Nebraska
Notified: 6-1-2016

2. GENERAL REGULATIONS

2.3 OBLIGATIONS OF THE CUSTOMER

2.3.10 JURISDICTIONAL REPORT REQUIREMENTS

B. Jurisdictional Requirements (Cont'd)

1. Feature Group A or Feature Group B

a. Feature Group A (FGA) to be Resold

Upon ordering FGA Service to be resold, the customer shall state in its initial order a projected PIU factor as set forth in B., preceding. The PIU factor is reported by State. When the customer reports a State-level PIU factor, the specified percentage applies to all end offices within the State.

(C)
(C)

The projected PIU factor is used by the Company to apportion the originating and terminating usage between interstate and intrastate until a revised report is received as set forth in C., following. The number of access minutes (either the measured minutes or the assumed minutes) is multiplied by the projected PIU factor to develop the interstate access minutes. The number of access minutes minus the developed interstate access minutes is the developed intrastate access minutes. This PIU factor is in addition to the PIU factor as set forth in 3., following.

b. Feature Group A (FGA) Not to be Resold

For FGA Service not to be resold, the customer shall state in its initial order a projected PIU factor of zero percent (0%) by lineside termination or access service group.

c. Feature Group B (FGB) Service

Upon ordering FGB Service, the customer shall state in its initial order a projected PIU factor as set forth in B., preceding. The PIU factor is reported by State. When the customer reports a State-level PIU factor, the specified percentage applies to all end offices within the State.

(C)
(C)

The projected PIU factor for FGB Service used by the Company to apportion the originating and terminating usage between interstate and intrastate is developed in the same manner as in a., preceding. This PIU factor is in addition to the PIU factor as set forth in 3., following.

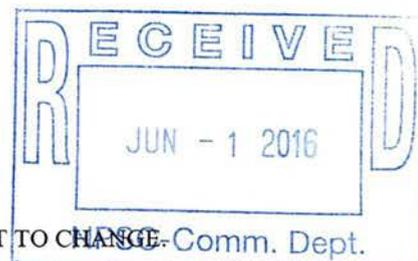

NOTICE

THE INFORMATION CONTAINED IN THIS DOCUMENT IS SUBJECT TO CHANGE-Comm. Dept.
NE2016-001

Qwest Corporation
Access Service
Catalog

SECTION 2
Page 15
Release 2
Effective: 7-1-2016

State of Nebraska
Notified: 6-1-2016

2. GENERAL REGULATIONS

2.3 OBLIGATIONS OF THE CUSTOMER

2.3.10 JURISDICTIONAL REPORT REQUIREMENTS

B. Jurisdictional Requirements (Cont'd)

2. Feature Group C (FGC) or Feature Group D (FGD) Service

a. Originating FGC or FGD Service

When a customer orders FGC or FGD Switched Access Service(s), where the jurisdiction is determined from the call detail, the Company will develop the projected PIU factor according to such jurisdiction. The projected interstate percentage is developed on a monthly basis, by end office, when the originating FGC or FGD access minutes are measured, by dividing the measured interstate originating access minutes by the total originating access minutes.

b. Terminating FGC Service

When a customer orders terminating FGC Switched Access Service, the data used by the Company to develop the projected PIU factor for originating FGC access minutes is used to develop the projected PIU factor for such terminating access minutes. When originating call details are insufficient to determine the jurisdiction for the call, the customer may supply the projected PIU factor by State[1] or authorize the Company to use the Company developed percentage for such call detail. The Company will designate the number obtained by subtracting the projected PIU factor for originating and terminating access minutes calculated by the Company from 100 (100 - Company calculated projected interstate percentage = intrastate percentage) as the intrastate percentage of use.

(C)

[1] When the customer reports a State-level PIU factor, the specified percentage applies to all end offices within the State.

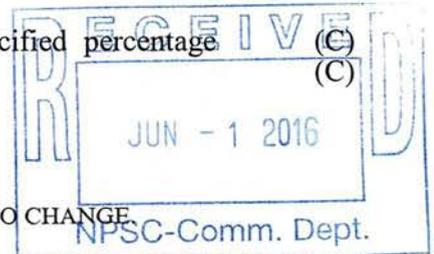

Qwest Corporation
Access Service
Catalog

SECTION 2
Page 16
Release 4
Effective: 7-1-2016

State of Nebraska
Notified: 6-1-2016

2. GENERAL REGULATIONS

2.3 OBLIGATIONS OF THE CUSTOMER

2.3.10 JURISDICTIONAL REPORT REQUIREMENTS

B.2. (Cont'd)

c. Terminating FGD Service

When a customer orders terminating FGD, if the Company has sufficient call details to determine the jurisdiction for the call, the Company will bill the call minutes of use according to that jurisdiction, unless the parties agree on a more accurate methodology.

When terminating call details are insufficient to determine the jurisdiction for the call, see A, preceding, the customer may supply the projected PIU factor for a portion of the indeterminate jurisdiction by State[1]. The projected PIU factor will be used to apportion the terminating traffic which does not exceed the 7% floor. (C)

When terminating call details are insufficient to determine the jurisdiction, and the customer does not supply a projected PIU factor by State, calls will be billed using a PIU of 50 (50% interstate – 50% intrastate). The PIU of 50 will be used to apportion the terminating traffic which does not exceed the 7% floor. (C)

In the event that the Company applies the intrastate terminating access rate to calls without sufficient call detail as provided in this tariff, the customer will have the opportunity to request backup documentation regarding the Company's basis for such application, and further request that the Company change the application of the intrastate access rate upon a showing of why the intrastate rate should not be applied. (See also Section 2.4.1.B.2.c, billing disputes.)

[1] When the customer reports a State-level PIU factor, the specified percentage applies to all end offices within the State. (C)

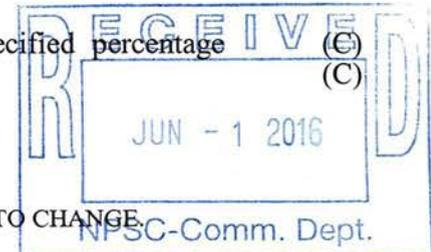

Qwest Corporation
Access Service
Catalog

SECTION 2

Page 17

Release 2

Effective: 7-1-2016

State of Nebraska
Notified: 6-1-2016

2. GENERAL REGULATIONS

2.3 OBLIGATIONS OF THE CUSTOMER

2.3.10 JURISDICTIONAL REPORT REQUIREMENTS

B. Jurisdictional Requirements (Cont'd)

3. Entrance Facility (EF) and Direct-Trunked Transport (DTT) Facility (Excludes Voice Grade (VG) EF and DTT for Feature Group A)

For EF and DTT facilities, the customer has the following jurisdiction options; 1) allow the Company to develop the projected State-level PIU factor using a mechanized program as set forth in a., following, or 2) provide the Company with a projected State-level PIU factor via a quarterly jurisdictional report as set forth in b., following. (C)

Customers initially ordering Switched Access Services in the LATA for the first time, shall provide on the access order a State-level PIU factor for new EF and DTT facilities based on all the originating and terminating traffic using such facilities. The Company will use the State-level PIU factor from the customer's initial order for service as the State-level PIU factor for the Company's mechanized program for the first quarter of new service only. After the first quarter of new service, the Company will develop the State-level PIU factor as described in a., following, until the Company receives a certified letter from the customer authorizing the Company to develop the projected PIU factor from a customer-provided report as set forth in b., following. (C)

a. Company-Developed EF and DTT PIU Factor

The Company-developed State-level PIU factors for EF and DTT facilities are updated on a quarterly basis by calculating the customer's average billed Interstate usage (excluding VG EF and DTT facilities for FGA) for the last three months. The Company will perform the calculation for the revised State-level PIU factor no later than the last business day in January, April, July and October, respectively. The Company-developed State-level PIU factor will serve as the basis for the customer's next three months' advance billing beginning in February, May, August and November, respectively. (C)

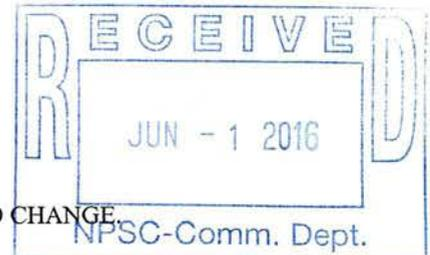

NOTICE

THE INFORMATION CONTAINED IN THIS DOCUMENT IS SUBJECT TO CHANGE
NE2016-001

Qwest Corporation
Access Service
Catalog

SECTION 2
Page 18
Release 2
Effective: 7-1-2016

State of Nebraska
Notified: 6-1-2016

2. GENERAL REGULATIONS

2.3 OBLIGATIONS OF THE CUSTOMER
2.3.10 JURISDICTIONAL REPORT REQUIREMENTS
B.3.a. (Cont'd)

When existing customers order additional EF and DTT facilities for Switched Access Service, the Company will determine the State-level PIU factor where jurisdiction can be determined from previously billed usage. The PIU factor is based on the average billed Switched Access Interstate usage (excluding VG EF and DTT facilities for FGA) per State, per customer on a quarterly basis. When the Company is unable to determine the State-level PIU factor for EF and DTT facilities for an existing customer because usage data is not being billed to that customer, the Company will apply a default PIU factor of fifty percent (50%).

The PIU factor is expressed as a whole number (i.e., a number 0 - 100). The PIU factor is used by the Company to determine interstate and intrastate rates and charges. The PIU factor is applied to all rate elements associated with EF and DTT facilities. This PIU factor is in addition to the PIU factors as set forth in 1. and 2., preceding, and 5., following.

b. Customer-Provided EF and DTT PIU Factor

Customers who choose to provide a projected State-level PIU factor for EF and DTT facilities, shall notify the Company by letter (certified U S Mail, return receipt requested) authorizing the Company to develop the projected State-level PIU factor from a customer-provided quarterly report. Customer's choosing to provide a projected State-level PIU factor shall base the PIU factor on all the originating and terminating traffic using the EF and DTT facilities in the State. The customer-provided jurisdictional report must be received by the Company no later than fourteen (14) days after the first of January, April, July and October in order for the customer-provided PIU factor to serve as the basis for the next three month's advance billing beginning in February, May, August and November, respectively. The Company will program the customer-provided revised PIU factor into the Company's billing data base no later than the last business day in January, April, July and October, respectively. If the customer does not provide the jurisdictional report in time for the Company to program the billing data base, the Company will continue to develop a State-level PIU factor for the quarter as the Company's billing data base can only be programmed with one PIU process at a time in the same quarter.

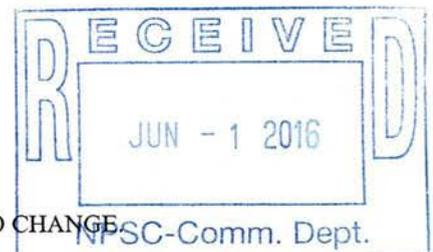

Qwest Corporation
Access Service
Catalog

SECTION 2
Page 19
Release 2
Effective: 7-1-2016

State of Nebraska
Notified: 6-1-2016

2. GENERAL REGULATIONS

2.3 OBLIGATIONS OF THE CUSTOMER

2.3.10 JURISDICTIONAL REPORT REQUIREMENTS

B.3.b. (Cont'd)

For existing customers who provide a quarterly report and the report is not received by the Company in time for the Company to program the revised State-level PIU factor for EF and DTT facilities in the State, the Company will assume the EF and DTT PIU factors to be the same as those provided in the last quarterly report and follow the steps as set forth in C., following. (C)

Customers who choose to provide a projected State-level PIU factor for EF and DTT facilities shall supply a percentage in a whole number (i.e., a number 0-100) by State. The PIU factor is used by the Company to determine interstate and intrastate rates and charges. The PIU factor is applied to all rate elements associated with EF and DTT facilities. This PIU factor is in addition to the PIU factors as set forth in 1. and 2., preceding, and 5., following. (C)

Customers may request to change from a quarterly customer-provided State-level PIU factor to a Company-developed State-level PIU factor for their EF and DTT facilities in the State. The customer must notify the Company (by certified U. S. Mail, return receipt requested) no later than fourteen (14) days after the first of January, April, July and October in order for the Company-developed State-level PIU factor as set forth in a., preceding to serve as the basis for the next three months' advance billing beginning in February, May, August and November, respectively. The Company will program the PIU factor into the Company's billing data base no later than the last business day of January, April, July and October for the advance quarterly billing beginning in February, May, August and November, respectively. If the customer does not notify the Company in time for the Company to program the billing data base with the Company-developed State-level PIU factor, the customer must continue to provide a quarterly jurisdictional report for the quarter as the Company's billing data base can only be programmed with one PIU process at a time in the same quarter. (C)

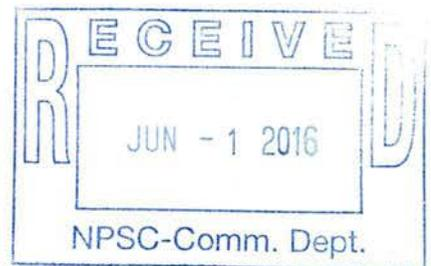

NOTICE

THE INFORMATION CONTAINED IN THIS DOCUMENT IS SUBJECT TO CHANGE.

NE2016-001

Qwest Corporation
Access Service
Catalog

SECTION 2
Page 20
Release 2
Effective: 7-1-2016

State of Nebraska
Notified: 6-1-2016

2. GENERAL REGULATIONS

2.3 OBLIGATIONS OF THE CUSTOMER
2.3.10 JURISDICTIONAL REPORT REQUIREMENTS
B.3. (Cont'd)

- c. Voice Grade (VG) EF and DTT facilities for Feature Group A (FGA) to be Resold

Customers initially ordering a VG EF and a DTT facility for FGA to be resold shall provide a projected PIU factor for each new facility. These PIU factors shall reflect all originating and terminating traffic using these facilities and are in addition to the PIU factors as set forth in 1.a., preceding.

The PIU factor for the VG EF and DTT facility will be applied to all rate elements associated with the EF and DTT facility.

The PIU factor is expressed as a whole number (i.e., a number 0 - 100). The PIU factor will be used by the Company to determine interstate and intrastate rates and charges. If the customer does not provide the Company a Switched Access PIU factor for an EF or DTT facility, the Company will apply a default PIU factor of fifty percent (50%).

The PIU factor will be used by the Company until a revised PIU factor is reported as set forth in C., following. A Switched Access State-level PIU factor shall be provided for all VG EF and for all DTT facilities provided within a State for Feature Group A for the revised reports. These PIU factors will account for both the originating and terminating traffic of all services using these facilities within the State.

(C)
(C)
(C)

- d. Voice Grade (VG) EF and DTT facilities for Feature Group A (FGA) not to be Resold

Customers initially ordering a VG EF and a DTT facility for FGA not to be resold shall state a projected PIU factor of zero percent (0%) for each facility. This PIU factor is in addition to the PIU factor as set forth in 1.c., preceding.

4. Tandem-Switched Transport

For Tandem-Switched Transport, rates and charges will be apportioned by the Company between interstate and intrastate based upon the PIU factor for the serving arrangement (Feature Group), as set forth in 1. and 2., preceding, and 5., following.

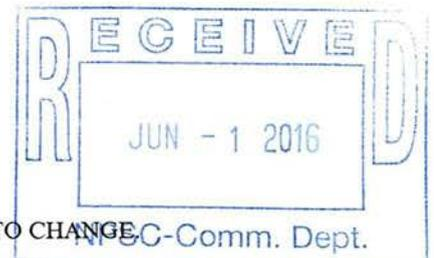

Qwest Corporation
Access Service
Catalog

SECTION 2
Page 21.1
Release 2
Effective: 7-1-2016

State of Nebraska
Notified: 6-1-2016

2. GENERAL REGULATIONS

2.3 OBLIGATIONS OF THE CUSTOMER

2.3.10 JURISDICTIONAL REPORT REQUIREMENTS

B. Jurisdictional Requirements

6. CCSAC(Cont'd)

The total of the PIU and POM shall not exceed 100. If the total of PIU and POM exceeds 100, then the PIU takes priority and the balance (100 - PIU) will be defaulted to POM. The Company will designate the number obtained by subtracting the projected PIU and POM factors furnished by the customer from 100 as the projected intrastate percentage of use. The projected PIU factor is used by the Company to apportion the message, monthly and nonrecurring charges associated with the CCS Link, STP Port, CCSAC Entrance Facility and Direct Link Transport between interstate and intrastate.

The projected PIU and POM are used to apportion the ISUP Call Set-up requests as interstate, intrastate and other for charging purposes. ISUP Call Set-up requests reported as POM will not be charged, provided that if the customer charges the Company for ISUP Call Set-up requests for Company originated traffic, the Company may charge the customer for ISUP Call Set-up requests associated with customer originated traffic in the same categories of traffic billed by the customer (i.e., local, EAS, intraMTA, Local Exchange Company portion of jointly provided switched access or Company originated toll traffic).

If a customer does not provide a PIU factor, the Company will apply a default PIU factor of fifty percent (50%). If a customer does not provide a POM factor, the Company will apply a default POM factor of zero percent (0%) except in those instances where the Company fails to provide the requested data described above with respect to the initial submission of the POM in a State, in which case the Company will apply a default CCSAC POM equal to the number obtained by subtracting the declared CCSAC PIU from 100. (C)

The PIU and POM factors will be used by the Company until a revised PIU or POM factor is reported as set forth in C., following. A State-level PIU and POM factor shall be provided for CCSAC Service provided within a State for the revised reports. (C)

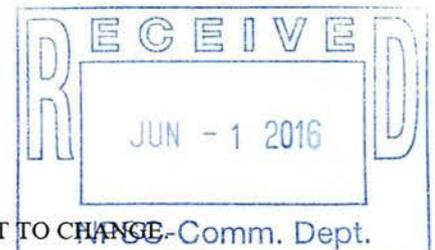

2. GENERAL REGULATIONS

2.3 OBLIGATIONS OF THE CUSTOMER

2.3.10 JURISDICTIONAL REPORT REQUIREMENTS

B. Jurisdictional Requirements (Cont'd)

7. Switched Access Service Expanded Interconnection Channel Termination

When a customer orders a Switched Access Service Expanded Interconnection Channel Termination (as set forth in Section 21), the customer shall state in its order the PIU factor in a whole number (i.e., a number 0 - 100). The Company will designate the number obtained by subtracting the projected interstate percentage furnished by the customer from 100 as the projected intrastate percentage of use.

The customer shall update the EICT PIU factor via a jurisdictional report as set forth in C., following. If the customer does not supply the reports, the Company will assume the PIU factors to be the same as those provided in the last quarterly report and follow the steps as set forth in C., following. For those cases in which a quarterly report has never been received from the customer, the Company will assume the PIU factors to be fifty percent (50%) until a revised PIU factor is provided via a jurisdictional report. Upon receipt of the customer's report, the Company will begin using the interstate percentage as set forth in C., following.

C. Jurisdictional Reports

1. Percent Interstate Use (PIU) Factor

Except where Company measured access minutes are used as set forth in B.2., preceding, the customer-provided PIU factor will be used until the customer reports a different projected PIU factor based on the following guidelines:

- a. The customer may update the PIU factor via jurisdictional report on a quarterly basis. The customer shall report the PIU factor by traffic and service type for each State. The customer shall forward to the Company a revised report, to be received no later than fourteen (14) days after the first of January, April, July and October. The revised report shall show the PIU factor for the most current data available, for each service arranged for interstate use. This data shall consist of at least three (3) and no more than twelve (12) consecutive months of data, ending no more than seventy-five (75) days earlier than the date the report is due (e.g., for the report due January 15th, the last month of data should be no earlier than October 31). The updated PIU factor shall be based on call detail records. The PIU factor can be based on a statistically valid sample. The PIU factor reported in January, April, July and October will be effective on the bill date of each such month and will serve as the basis for subsequent monthly billing pending the receipt of a revised PIU report.

(C)

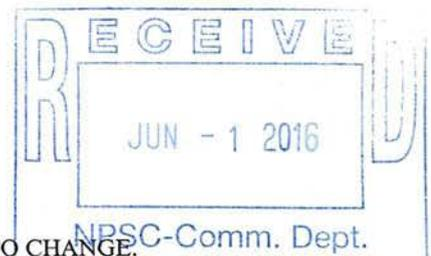

NOTICE

THE INFORMATION CONTAINED IN THIS DOCUMENT IS SUBJECT TO CHANGE.
NE2016-001

Qwest Corporation
Access Service
Catalog

SECTION 2
Page 23
Release 4
Effective: 09-19-2003

State of Nebraska
Notified: 09-08-2003

2. GENERAL REGULATIONS

2.3 OBLIGATIONS OF THE CUSTOMER

2.3.10 JURISDICTIONAL REPORT REQUIREMENTS

C.1. (Cont'd)

- b. No prorating or back billing will be done based on the jurisdictional report. However, usage will be billed utilizing the interstate percentage that was in effect at the time the usage was generated. (T)
- c. The customer shall maintain and retain the work papers that show how the interstate percentage was determined and a summary derived from the actual call detail records for a minimum twelve (12) month period which statistically substantiates each interstate percentage provided to the Company. This summary at a minimum shall include month, year, state, traffic type (e.g., originating, terminating, 700, 8XX, 900, etc.) and service type. (T)
- d. The Company may request the actual call detail records or a statistically valid sample of such records, on a prospective basis, not to exceed a consecutive three-month period. The actual call detail records will be used to statistically substantiate the interstate percentage provided to the Company and the process by which it is developed. Such call detail records shall consist of call information, including call terminating address (i.e., called number), call duration, the trunk group number(s), or access line number(s) over which the call is routed and the point at which the call enters the customer's network. The Company will not request such data more than once a year. (T)
- e. If quarterly reports are not supplied by the customer, the following steps will be taken by the Company: (T)
 - (1) If the customer does not supply the reports, the Company will assume the PIU factors to be the same as those provided in the last quarterly report. For those cases in which a quarterly report has never been received from the customer, the Company will assume the PIU factors to be the same as those provided in the order for service as set forth in B., preceding. In any case, the Company reserves the right to request actual call detail supporting the customer's reported PIU, as specified preceding. (T)
 - (2) If a quarterly report has never been received from the customer, and the customer failed to report a PIU in the order for service, the Company will designate a fifty percent (50%) interstate percentage beginning with the next billing period. This interstate percentage will be applied until a quarterly PIU report is submitted. (T)

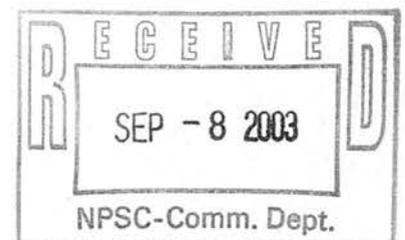

NOTICE

THE INFORMATION CONTAINED IN THIS DOCUMENT IS SUBJECT TO CHANGE.
NE2003-046

2. GENERAL REGULATIONS

2.3 OBLIGATIONS OF THE CUSTOMER

2.3.10 JURISDICTIONAL REPORT REQUIREMENTS

C. Jurisdictional Reports (Cont'd)

2. Percent Other Message (POM) Factor

The customer-provided POM factor will apply to CCSAC ISUP Call Set-up requests only, and will be used until the customer reports a different projected POM factor based on the following guidelines:

- a. The customer may update the POM factor via jurisdictional report on a quarterly basis. The customer shall report the POM factor for each State. The customer shall forward to the Company a revised report, to be received no later than fourteen (14) days after the first of January, April, July and October. The revised report shall show the POM factor for the most current data available. This data shall consist of at least three (3) and no more than twelve (12) consecutive months of data, ending no more than seventy-five (75) days earlier than the date the report is due (e.g., for the report due January 15th, the last month of data should be no earlier than October 31). The updated POM factor shall be based on actual records, defined as either call detail records, call message counts (including incomplete attempts) or signaling message records. The POM factor may be based on a statistically valid sample. The POM factor reported in January, April, July and October will be effective on the bill date of each such month and will serve as the basis for subsequent monthly billing pending the receipt of a revised POM report. If the customer requests the Company to provide data, per the terms of Section 2.3.10.B.6, preceding, the data provided by the Company will comply with the terms of this section. (C)
- b. No prorating or back billing will be done based on the jurisdictional report. However, usage will be billed utilizing the POM percentage that was in effect at the time the usage was generated.
- c. The customer shall maintain and retain the work papers that show how the POM was determined and a summary derived from the actual records for a minimum twelve (12) month period which statistically substantiates each POM provided to the Company. This summary at a minimum shall include month, year and state. If the customer requests the Company to provide data, per the terms of Section 2.3.10.B.6, preceding, the Company will comply with the terms of this Section with respect to the data it provides.

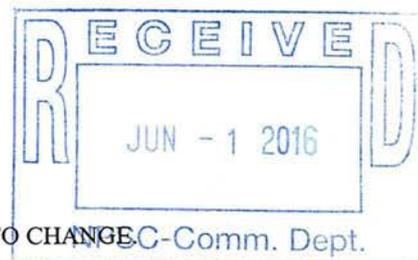

NOTICE

THE INFORMATION CONTAINED IN THIS DOCUMENT IS SUBJECT TO CHANGE. C-Comm. Dept.
NE2016-001

Qwest Corporation
Access Service
Catalog

SECTION 2
Page 24.1
Release 1

State of Nebraska
Notified: March 3, 2005

Effective: March 14, 2005

2. GENERAL REGULATIONS

2.3 Obligations Of The Customer

2.3.10 JURISDICTIONAL REPORT REQUIREMENTS

C. Jurisdictional Reports

2. Percent Other Message (POM) Factor(Cont'd)

- d. The Company may request the data used to develop the POM, or a statistically valid sample of such data, on a prospective basis, not to exceed a consecutive three-month period. The data will be used to statistically substantiate the POM provided to the Company and the process by which it is developed. Such data shall consist of call or message information of sufficient detail to substantiate the jurisdictional factors provided by the customer. If the Company has provided data, as requested by the customer per the terms of Section 2.3.20.B.6, preceding, this data will not be part of the request and is not the responsibility of the customer. In addition, the customer may request more detailed data used to develop the summary data provided by the Company or a statistically valid sample of such data, on a prospective basis, not to exceed a consecutive three month period. In response to this request the Company will provide data by trunk group. (T-M)
(T-M)
(M)
(C-M)
(C-M)
- e. Except as provided in Section 2.3.10.B.6 where the Company fails to provide requested data, if a quarterly report has never been received from the customer, and the customer failed to report a POM in the order for service, the Company will designate a zero percent (0%) POM beginning with the next billing period. This POM will be applied until a quarterly POM report is submitted. (C-M)
(C-M)
(M)
(C-M)
(M)

(M) Material moved from Page 24.



NOTICE

THE INFORMATION CONTAINED IN THIS DOCUMENT IS SUBJECT TO CHANGE.
NE2005-006

Qwest Corporation
Access Service
Catalog

SECTION 2
Page 25
Release 2
Effective: 07-21-2003

State of Nebraska
Notified: 07-09-2003

2. GENERAL REGULATIONS

2.3 OBLIGATIONS OF THE CUSTOMER

2.3.10 JURISDICTIONAL REPORT REQUIREMENTS (Cont'd)

D. The Company will provide annual reports to the Commission on March 1st showing the interstate percentage reported to the Company over the previous calendar year by Switched Access Service customers. (M)

E. Jurisdictional Report Dispute and Auditing Procedures (M)

If a billing dispute arises concerning the projected interstate percentage, the Company will ask the customer to provide the data the customer uses to determine the projected interstate percentage as described in 1. and 2., following.

1. Switched Access Services

a. If the Company questions the information provided by the customer in C., preceding, the Company will send a letter to the customer (by certified U.S. Mail, return receipt requested) requesting that the customer contact the Company to discuss and explain their report within thirty (30) days of the Company's request.

b. If no response is received from the customer, the Company will send a letter to the customer (by certified U.S. Mail, return receipt requested) requesting the work papers and summary as described in C., preceding, used by the customer to substantiate the most recent interstate percentage. The requested information must be submitted by the customer to the Company within thirty (30) days after receipt of the certified letter.

c. If the customer submits the work papers and summary as requested in b., preceding, the Company will review this information within thirty (30) days after receipt of the customer's information.

d. If after review of the documentation, the Company and the customer establish a revised interstate percentage, the Company will begin using the percentage with the next billing period.

e. If the Company and the customer do not establish a revised interstate percentage, the Company will begin the procedures as set forth in g., following.

f. If no response is received from the customer, the Company will begin the auditing procedures as set forth in g., following, and notify the Commission. (M1)

g. When jurisdictional reports are not provided by the customer or a billing dispute arises, the Company may request an audit. The audit procedures and responsible party(ies) for payment of audit expenses will be determined as follows:

(M) Material moved from Page 23. (M2)

(M1) Material moved from Page 24.

(M2) Material moved to Page 26.

NOTICE

THE INFORMATION CONTAINED IN THIS DOCUMENT IS SUBJECT TO CHANGE.
NE2003-003

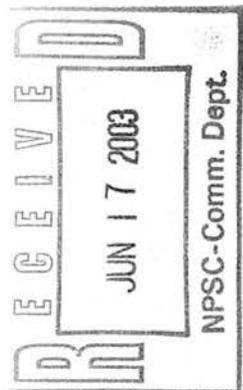

Qwest Corporation
Access Service
Catalog

SECTION 2

Page 26

Release 3

Effective: 07-21-2003

State of Nebraska
Notified: 07-09-2003

2. GENERAL REGULATIONS

2.3 OBLIGATIONS OF THE CUSTOMER

2.3.10 JURISDICTIONAL REPORT REQUIREMENTS

E.1.g. (Cont'd)

- If the Company and the customer mutually agree upon an independent Certified Public Accountant (CPA) auditing firm and the party(ies) agree to equally share in the payment of audit expenses, both the Company and the customer will be bound by such agreement; or
 - The customer may select an independent CPA auditing firm and pay all audit expenses.
 - If the audit is not conducted as set forth preceding, the Company may select an independent CPA auditing firm and pay all expenses.
- h. The Company will adjust the customer's PIU based upon the audit results. The PIU resulting from the audit shall be applied to the usage for the quarter the audit is completed, the usage for the quarter prior to completion of the audit and the usage for the two (2) quarters following the completion of the audit. After that time, the customer may report a revised PIU pursuant to C., preceding. The Company will implement the revised interstate percentage to the next billing period or quarterly report date, whichever is first.

(T)

(M)

(M)

2. Access Service Billing

For Access Service Billing (as described in 13.3.6), the Company will ask the customer to provide the data the customer uses to determine the projected interstate percentage if a billing dispute arises or the commission questions the customer-provided interstate percentage. The customer shall supply the data within thirty (30) days of the Company request. The Company will not request such data more than once a year. The customer shall keep records of system design and functions from which the percentage of interstate and intrastate use can be ascertained and, upon request of the Company, make the records available for inspection as reasonably necessary for purposes of verification of the percentages.

3. Jurisdictional Report Proprietary Information

The data the customer provides to the Company to support their interstate percentage is considered proprietary to the customer. The Company agrees to use and protect such information by exercising the same degree of care normally used to protect its own proprietary information.

(M) Material moved from Page 25.

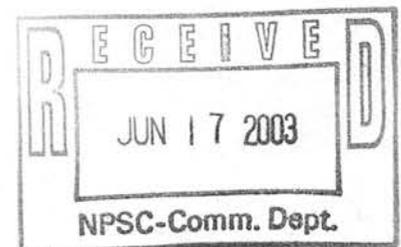

NOTICE

THE INFORMATION CONTAINED IN THIS DOCUMENT IS SUBJECT TO CHANGE.
NE2003-003

2. GENERAL REGULATIONS

2.3 OBLIGATIONS OF THE CUSTOMER

2.3.10 JURISDICTIONAL REPORT REQUIREMENTS

E. Jurisdictional Report Dispute and Auditing Procedures (Cont'd)

4. Contested Audits

When a jurisdictional audit is conducted by the Company or an independent Certified Public Accountant (CPA) auditing firm selected by the Company, the audit results will be furnished to the customer by certified U.S. Mail (return receipt requested). The customer may contest the audit results by providing written notification (by certified U.S. Mail, return receipt requested), to the Company within fifteen (15) calendar days from the date the audit report is furnished to the customer by certified U.S. Mail (return receipt requested). When a jurisdictional audit is conducted by an independent Certified Public Accountant (CPA) auditing firm selected by the customer, the audit results will be furnished to the Company by certified U.S. Mail (return receipt requested). The Company may contest the audit results by providing written notification (by certified U.S. Mail, return receipt requested) to the customer within fifteen (15) calendar days from the date the audit report is furnished to the Company by certified U.S. Mail (return receipt requested).

Contested audits will be resolved by the Company and the customer within thirty (30) days of written notification, or a neutral arbitrator will be mutually agreed upon by the Company and the customer. During the initial thirty (30) day resolution period, the Company and the customer will review the audit process and the data used to calculate the PIU factor, in an attempt to resolve the dispute. Should the Company and the customer resolve the dispute on the PIU factor, a neutral arbitrator would not be warranted.

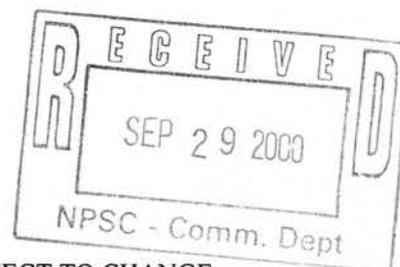

2. GENERAL REGULATIONS

2.3 OBLIGATIONS OF THE CUSTOMER
2.3.10 JURISDICTIONAL REPORT REQUIREMENTS

E.4. (Cont'd)

Contested audits will be resolved by a neutral arbitrator mutually agreed upon by the Company and the customer. The arbitration hearing will be conducted in Denver, Colorado or a state and location within the Company operating territory that is mutually agreed upon by both parties. The arbitration proceeding, including the decision rendered, shall be governed by the law (both statutory and case) of the state in which the arbitration hearing is held, including, but not limited to the Uniform Arbitration Act, as adopted in that state.

Prior to the arbitration hearing, each party shall notify the arbitrator of the PIU factor which that party believes to be correct. The arbitrator, in deciding, may adopt the PIU factor of either party or may adopt a PIU factor different from those proposed by the parties.

If the arbitrator adopts a PIU factor proposed by one of the parties, the other party (whose PIU factor was not adopted) shall pay all costs of the arbitration. If the arbitrator adopts a PIU factor higher than the PIU factors proposed by both parties, then the party proposing the lower PIU factor shall pay all costs of the arbitration. If the arbitrator adopts a PIU factor lower than the PIU factor proposed by both parties, then the party proposing the higher PIU factor shall pay all costs of the arbitration. If the arbitrator adopts a PIU factor which falls between the two factors proposed by the parties, then the parties shall each pay one-half of the arbitration costs.

Absent written notification, within the time frame as set forth preceding, audit results cannot be contested and the Company will adjust the customer's PIU factor based upon the audit results as set forth in C., preceding.

F. Application of PIU

When the Access Service is not available in the interstate jurisdiction, the PIU factor must be zero percent (0%).

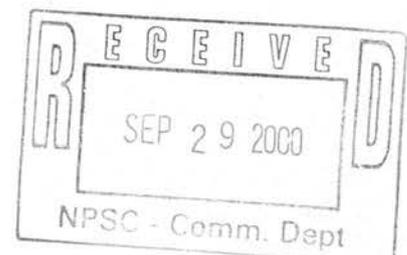

Qwest Corporation
Access Service
Catalog

SECTION 2
Page 28.1
Release 2
Effective: 7-13-2012

State of Nebraska
Notified: 7-2-2012

2. GENERAL REGULATIONS

2.3 OBLIGATIONS OF THE CUSTOMER

2.3.10 JURISDICTIONAL REPORT REQUIREMENTS (Cont'd)

G. Identification and Rating of VoIP-PSTN Traffic

VoIP-PSTN Traffic is defined as traffic exchanged between a Company end user and the customer in Time Division Multiplexing (TDM) format that originates and/or terminates in Internet Protocol (IP) format. This section governs the identification and compensation of VoIP-PSTN Traffic that is required to be compensated at access rates unless the parties have agreed otherwise by the F.C.C. in its Report and Order in WC Dockets Nos. 10-90, etc., F.C.C. Release No. 11-161 (November 18, 2011) (F.C.C. Order). Specifically, this section establishes the method of separating VoIP-PSTN Traffic from the customer's traditional intrastate access traffic, so that VoIP-PSTN Traffic can be billed in accordance with the F.C.C. Order.

(C)
(C)

The FCC released its Second Order of Reconsideration in WC Docket No. 10-90, etc., FCC Release No. 12-47 (April 25, 2012) which temporarily modified the compensation of originating VoIP-PSTN Traffic on a prospective basis. Upon receipt, validation and acceptance of the Percent VoIP Usage factor, originating VoIP-PSTN Traffic will be compensated as follows:

(N)

- Between the Initial Implementation date described in 2.3.10.G.2 and July 12, 2012, the applicable rate elements used in providing originating access for VoIP-PSTN Traffic and associated facilities will be billed according to interstate access rates.
- Effective July 13, 2012 the applicable rate elements used in providing originating access for intrastate VoIP-PSTN Traffic and associated facilities will be billed according to intrastate access rates. The applicable rate elements used in providing originating access for interstate VoIP-PSTN Traffic and associated facilities will be billed according to interstate access rates.
- Effective July 1, 2014 the applicable rate elements used in providing originating access for intrastate VoIP-PSTN Traffic and associated facilities will be billed according to interstate access rates.
- After the Initial Implementation date described in 2.3.10.G.2, terminating VoIP-PSTN Traffic and associated facilities will be billed according to interstate access rates.

(N)

(M)

(M) Material moved to Page 28.2.

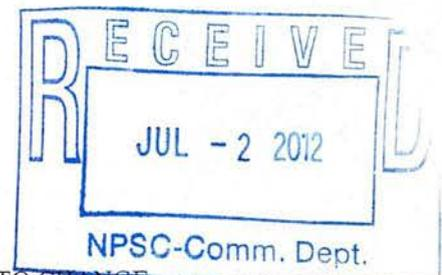

NOTICE

THE INFORMATION CONTAINED IN THIS DOCUMENT IS SUBJECT TO CHANGE.
NE2012-010

Qwest Corporation
Access Service
Catalog

SECTION 2
Page 28.2
Release 3

State of Nebraska
Notified: 6-1-2016

Effective: 7-1-2016

2. GENERAL REGULATIONS

2.3 OBLIGATIONS OF THE CUSTOMER

2.3.10 JURISDICTIONAL REPORT REQUIREMENTS

G. Identification and Rating of VoIP-PSTN Traffic (Cont'd)

VoIP-PSTN Traffic and associated facilities identified in accordance with this tariff section will be billed at rates equal to the Company's applicable tariffed interstate switched access rates as set forth in CenturyLink Operating Companies F.C.C. No. 11 Tariff when applicable based on the schedule shown above.

(T)
(T)

1. Calculation and Application of Percent-VoIP- Usage Factors

- a. The Company will determine the number of VoIP-PSTN Traffic minutes of use (MOU) to which interstate rates will be applied under B, preceding, by applying an originating Percent VoIP Usage (PVU) factor to the total intrastate access MOU originated by a Company end user and delivered to the customer and by applying a terminating PVU factor to the total intrastate access MOU terminated by a customer to the Company's end user.
- b. The Company will use state average data and the customer provided Facility PVU to determine the monthly recurring credit for terminating VoIP-PSTN Traffic.
- c. The customer will calculate and furnish to the Company an originating PVU factor representing the whole number percentage of the customer's total originating intrastate access MOU that the customer exchanges with the Company in the State that is received from the Company and that is terminated in IP format and that would be billed by the Company as intrastate access MOU.
- d. The customer will calculate and furnish to the Company a terminating PVU factor representing the whole number percentage of the customer's total terminating intrastate access MOU that the customer exchanges with the Company in the State that is sent to Company and which originated in IP format and that would be billed by the Company as intrastate access MOU.
- e. The customer shall not modify their reported PIU factor to account for VoIP-PSTN Traffic.
- f. The customer will calculate and furnish to the Company a Facility PVU factor representing the whole number percentage of the customer's total monthly recurring switched transport charges that are associated with the intrastate access MOU included in the PVU factor.

(C)

(C)



2. GENERAL REGULATIONS

2.3 OBLIGATIONS OF THE CUSTOMER

2.3.10 JURISDICTIONAL REPORT REQUIREMENTS

G. Identification and Rating of VoIP-PSTN Traffic

1. Calculation and Application of Percent-VoIP- Usage Factors (Cont'd)

- g. Both the customer provided originating PVU and the terminating PVU and the Facility PVU shall be based on information such as the number of the customer's retail VoIP subscriptions in the state (e.g. as reported on F.C.C. Form 477), traffic studies, actual call detail or other relevant and verifiable information which will be provided to the Company upon request. (T)(M)(C)
- h. The customer shall retain the call detail, work papers, and information used to develop the PVU factors for a minimum of one year. (T)
- i. If the Customer does not furnish the Company with a PVU factor, the Company will utilize a PVU equal to zero. (T)

2. Initial Implementation of PVU Factors

- a. If the PVU factors cannot be implemented in the Company's billing systems by December 29, 2011, once the factors can be implemented the Company will adjust the customer's bills to reflect the PVU factors prospectively in the next bill period if the PVU factors are provided by the customer to the Company prior to April 15, 2012.
- b. The Company may choose to provide credits based on the reported PVU factors on a quarterly basis until such time as the billing system modifications can be implemented.

3. PVU Factor Updates

The customer may update the PVU factors quarterly using the method set forth in 1.c, preceding. If the customer chooses to submit such updates, it shall forward to the Company, no later than 15 days after the first day of January, April, July and/or October of each year, revised PVU factors based on data for the prior three months, ending the last day of December, March, June and September, respectively. The revised PVU factors will serve as the basis for future billing and will be effective on the bill date of each such month and shall serve as the basis for subsequent monthly billing until superseded by new PVU factors. No prorating or back billing will be done based on the updated PVU factors. (M)(M1)

(M) Material moved from Page 28.2.

(M1) Material moved to Page 28.4.



Qwest Corporation
Access Service
Catalog

SECTION 2
Page 28.4
Release 2
Effective: 7-13-2012

State of Nebraska
Notified: 7-2-2012

2. GENERAL REGULATIONS

2.3 OBLIGATIONS OF THE CUSTOMER

2.3.10 JURISDICTIONAL REPORT REQUIREMENTS

G. Identification and Rating of VoIP-PSTN Traffic (Cont'd)

4. PVU Factor Verification

- a. Not more than twice in any year, the Company may request from the customer an overview of the process used to determine the PVU factors, the call detail records, description of the method for determining how the end user originates and terminates calls in IP format, and other information used to determine the customer's PVU factors furnished to the Company in order to validate the PVU factors supplied. The customer shall comply, and shall reasonably supply the requested data and information within 15 days of the Company's request.
- b. The Company may dispute the Customer's PVU factor based upon:
 - A review of the requested data and information provided by the customer, or customer's refusal to provide the data and information to support the PVU factors.
 - The Company's reasonable review of other market information, F.C.C. reports on VoIP lines, such as F.C.C. Form 477 or state level results based on the F.C.C. Local Competition Report or other relevant data.
 - A change in the reported PVU factor by more than five percentage points from the preceding quarter.
- c. If after review of the data and information, the customer and the Company establishes revised PVU factors, the Company will begin using those revised PVU factors with the next bill period.

(M)

(T)
(C)
(C)

(M)

(M1)

(M) Material moved from Page 28.3.

(M1) Material moved to Page 28.5.

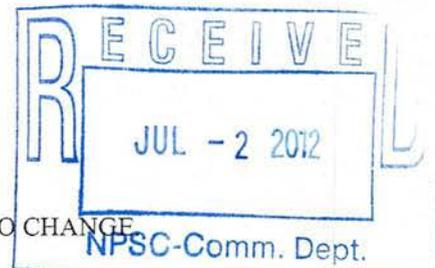

2. GENERAL REGULATIONS

2.3 OBLIGATIONS OF THE CUSTOMER

2.3.10 JURISDICTIONAL REPORT REQUIREMENTS

G. Identification and Rating of VoIP-PSTN Traffic

4. PVU Factor Verification (Cont'd)

d. If the dispute is unresolved, the Company may initiate an audit. The Company shall limit audits of the customer's PVU factor to no more than twice per year. The customer may request that the audit be conducted by an independent auditor. In such cases the associated auditing expenses will be paid by the customer.

(M)

- In the event that the customer fails to provide adequate records to enable the Company or an independent auditor to conduct an audit verifying the customer's PVU factors, the Company will bill the usage and associated facilities for all contested periods using the most recent undisputed PVU factors reported by the customer. If no undisputed PVU factors exist, then PVU factors of zero percent will be used for all contested periods. These PVU factors will remain in effect until the audit can be completed.

(C)

(C)

- During the audit, the most recent undisputed PVU factors from the previous reporting period will be used by the Company.

- The Company will adjust the customer's PVU factors based on the results of the audit and implement the revised PVU in the next billing period or quarterly report date, whichever is first. The revised PVU factors will apply for the next two quarters before new factors can be submitted by the customer.

- If the audit supports the customer's PVU factors, the usage for the contested periods will be adjusted to reflect the customer's audited PVU factors.

(M)

(M) Material moved from Page 28.4.

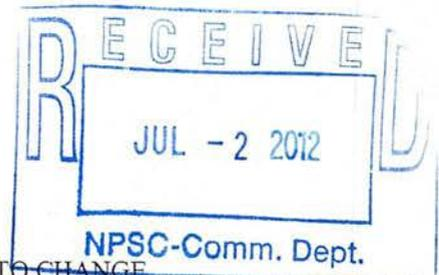

NOTICE

THE INFORMATION CONTAINED IN THIS DOCUMENT IS SUBJECT TO CHANGE.
NE2012-010

Qwest Corporation
Access Service
Catalog

SECTION 2
Page 29
Release 2
Effective: 7-1-2016

State of Nebraska
Notified: 6-1-2016

2. GENERAL REGULATIONS

2.3 OBLIGATIONS OF THE CUSTOMER (Cont'd)

2.3.11 DETERMINATION OF JURISDICTION FOR MIXED INTERSTATE AND INTRASTATE ACCESS SERVICE BILLING

- A. When an Access Service Bill (as described in 13.3.6) contains both interstate and intrastate billing, the jurisdiction will be determined as follows:
1. If the customer's estimate of the interstate charges on the bill constitutes more than ten percent of the total charges on that bill, the bill will be provided in accordance with the applicable rules and regulations of F.C.C. No. 11. (T)
 2. If the customer's estimate of the interstate charges on the bill constitutes ten percent or less of the total charges on that bill, the bill will be provided in accordance with the appropriate terms and conditions of this Catalog.

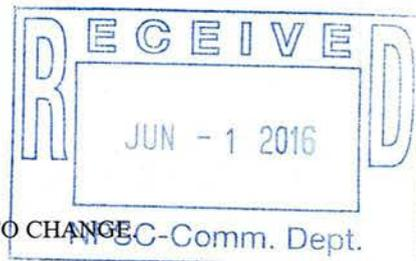

Qwest Corporation
Access Service
Catalog

SECTION 2

Page 30

Release 2

State of Nebraska
Notified: 09-08-2003

Effective: 09-19-2003

2. GENERAL REGULATIONS

2.3 OBLIGATIONS OF THE CUSTOMER (Cont'd)

2.3.12 DETERMINATION OF INTRASTATE CHARGES FOR MIXED INTERSTATE AND INTRASTATE ACCESS SERVICE

A. PIU

(N)

For all Access Service except those services as set forth in 2.3.11, preceding, where mixed interstate and intrastate Access Service is provided, all charges (i.e., nonrecurring, monthly and/or usage) including optional features charges, will be prorated between interstate and intrastate. The PIU factors provided in the jurisdictional reports as set forth in 2.3.10, preceding, will serve as the basis for prorating the charges. The percentage of an Access Service to be charged as interstate is applied in the following manner:

(T)

1. For monthly and nonrecurring chargeable rate elements, multiply the percent intrastate use times the quantity of chargeable elements, times the stated catalog rate per element. In the event that the customer has provided a separate percent intrastate use for terminating access for FGD, the projected PIU factor for originating access minutes of use will be used to determine the apportionment of charges.
2. For usage-sensitive (i.e., access minutes and calls) chargeable rate elements, multiply the percent interstate use times actual use (i.e., measured or Company assumed average use), times the stated catalog rate.

The PIU factor will change as revised usage reports are submitted as set forth in 2.3.10, preceding.

B. CCSAC PIU and POM

(N)

The CCSAC PIU and POM reports as set forth in 2.3.10, preceding, will serve as the basis for prorating the charges. The percentage of a CCSAC rate element to be charged as intrastate is applied in the following manner:

1. For the following chargeable rate elements: CCSAC Entrance Facility, Direct Link Transport, CCS Links, STP Port, Multiplexing, TCAP message charges, and all nonrecurring charges; multiply one hundred percent minus the CCSAC PIU times the quantity of chargeable elements times the stated Tariff rate per element.
2. For chargeable rate elements associated with ISUP Call Set-up requests, multiply the percent intrastate use (100 minus the sum of the CCSAC PIU plus the CCSAC POM) times the actual use times the stated Tariff rate.

The CCSAC PIU and POM factors will change as revised declarations are submitted as set forth in 2.3.10, preceding.

(N)

(M) Material moved to Page 31.

(M)

NOTICE

THE INFORMATION CONTAINED IN THIS DOCUMENT IS SUBJECT TO CHANGE.
NE2003-046

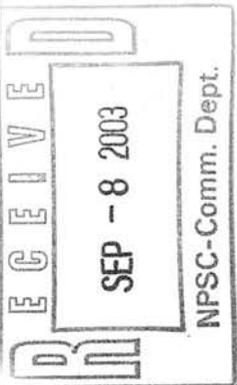

Qwest Corporation
Access Service
Catalog

SECTION 2

Page 31

Release 1

Effective: 09-19-2003

State of Nebraska
Notified: 09-08-2003

2. GENERAL REGULATIONS

2.3 OBLIGATIONS OF THE CUSTOMER

2.3.12 DETERMINATION OF INTRASTATE CHARGES FOR MIXED INTERSTATE AND INTRASTATE ACCESS SERVICE (Cont'd)

- C. When mixed interstate and intrastate Access Service is provided on those services set forth in 2.3.11, preceding, and the jurisdiction of the service is determined in accordance with 2.3.11 to be an interstate service, one-hundred percent (100%) of all recurring rates (i.e., daily and monthly) and all nonrecurring charges of this Tariff will apply. If the jurisdiction of the service is determined to be an intrastate service, one-hundred percent (100%) of the intrastate charges of this catalog will apply.

(T-M)

(M)

2.3.13 DETERMINATION OF THE CUSTOMER OF RECORD WHEN SWITCHED ACCESS SERVICE CONNECTS TO EXPANDED INTERCONNECTION SERVICE

The customer of record for Switched Access Service and the customer of record for Expanded Interconnection Service may be different. The customer of record is determined as set forth following:

- If the interexchange carrier uses an interconnector's services, the interconnector may order Switched Access Service and Expanded Interconnection Service in its own name in which case the interconnector will be the customer of record for both services.
- If the interconnector orders Switched Access Service as an agent for the interexchange carrier, the interexchange carrier will be the Switched Access Service customer of record and the interconnector will be the Expanded Interconnection Service customer of record.
- If the interexchange carrier orders the Switched Access Service directly, the interexchange carrier will be the Switched Access Service customer of record and the interconnector will be the Expanded Interconnection Service customer of record.

(M) Material moved from Page 30.

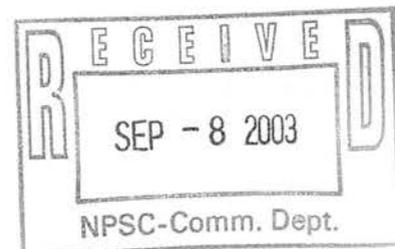

NOTICE

THE INFORMATION CONTAINED IN THIS DOCUMENT IS SUBJECT TO CHANGE.
NE2003-046

Qwest Corporation
Access Service
Catalog

SECTION 2

Page 32

Release 1

Effective: 9-29-2000

State of Nebraska
Notified: 9-29-2000

2. GENERAL REGULATIONS

2.4 PAYMENT ARRANGEMENTS AND CREDIT ALLOWANCES

2.4.1 PAYMENT OF RATES, CHARGES AND DEPOSITS

- A. The Company will, in order to safeguard its interests, only require a customer who has a proven history of late payments to the Company or does not have established credit to make a deposit prior to or at any time after the provision of service to the customer to be held by the Company as a guarantee of the payment of rates and charges. No such deposit will be required of a customer which is a successor of a company which has established credit and has no history of late payments to the Company. Such deposit may not exceed the actual or estimated rates and charges for the service for a two month period. The fact that a deposit has been made in no way relieves the customer from complying with the Company's regulations as to the prompt payment of bills. At such time as the provision of the service to the customer is terminated, the amount of the deposit will be credited to the customer's account, and any credit balance which may remain will be refunded. Such a deposit will be refunded or credited to the customer's account, and any credit balance which may remain will be refunded. Such a deposit will be refunded or credited to the account when the customer has established a one year promote payment record at any time prior to the termination of the provision of the service to the customer. In case of a cash deposit, for the period the deposit is held by the Company, the customer will receive interest at the same percentage rate as that set forth in B.2.b.(1) or in B.2.b.(2), following, whichever is lower.

The rate will be compounded daily for the number of days from the date the customer deposit is received by the Company to and including the date such deposit is credited to the customer's account or the date the deposit is refunded by the Company. Should a deposit be credited to the customer's account, as indicated above, no interest will accrue on the deposit from the date such deposit is credit to the customer's account.

- B. The Company shall bill on a current basis all charges incurred by and credits due to the customer under this Catalog attributable to services, including, but not limited to, Maintenance of Service as set forth in 13.3.1, following, established or discontinued during the preceding billing period. In addition, the Company shall bill in advance charges for all services to be provided during the ensuing billing period except for charges associated with service usage and for the Federal Government, which will be billed in arrears. The bill day (i.e., the billing date of a bill for a customer for Access Service under this Catalog), the period of service each bill covers, and the payment date will be as follows:

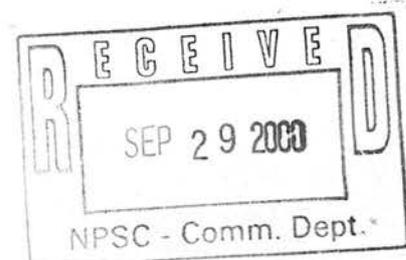

NOTICE

THE INFORMATION CONTAINED IN THIS DOCUMENT IS SUBJECT TO CHANGE.
NE2000-054

Qwest Corporation
Access Service
Catalog

SECTION 2

Page 33

Release 1

State of Nebraska
Notified: 9-29-2000

Effective: 9-29-2000

2. GENERAL REGULATIONS

2.4 PAYMENT ARRANGEMENTS AND CREDIT ALLOWANCES

2.4.1 PAYMENT OF RATES, CHARGES AND DEPOSITS

B. (Cont'd)

1. For Miscellaneous Services and non-usage-sensitive Switched Access Service charges, the Company will establish a bill day each month for each customer account. The bill will cover non-usage-sensitive service charges for the ensuing billing period and any known unbilled non-usage-sensitive charges. Any known unbilled usage charges for prior periods and any known unbilled adjustments will also be applied to this bill. Payment for such bills is due as set forth in 2., following. If payment is not received by the payment date, as set forth in 2., following, in immediately available funds, a late payment penalty will apply as set forth in 2., following.

2. Payment Due Date and Late Payment Penalty

- a. All bills dated as set forth in 1., preceding, provided to the customer by the Company, are due (payment date) by the next bill date (i.e., same date in the following month as the bill date), except as provided herein, and are payable in immediately available funds. If such payment date would cause payment to be due on a Saturday, Sunday or holiday (i.e., New Year's Day, Independence Day, Labor Day, Thanksgiving Day, Veteran's Day, Christmas Day and a day when Washington's Birthday or Memorial Day or Columbus Day is legally observed) payment for such bills will be due from the customer as follows:

If such payment date falls on a Sunday or on a holiday which is observed on a Monday, the payment date shall be the first non-holiday day following such Sunday or holiday. If such payment date falls on a Saturday or on a holiday which is observed on Tuesday, Wednesday, Thursday or Friday, the payment date shall be the last non-holiday day preceding such Saturday or holiday.

- b. Further, if any portion of the payment is received by the Company after the payment date as set forth in a., preceding, or if any portion of the payment is received by the Company in funds which are not immediately available to the Company, then a late payment penalty shall be due to the Company. The late payment penalty shall be the portion of the payment not received by the payment date times a late factor. The late factor shall be the lesser of:

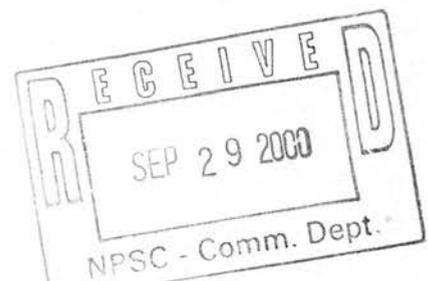

NOTICE

THE INFORMATION CONTAINED IN THIS DOCUMENT IS SUBJECT TO CHANGE.
NE2000-054

2. GENERAL REGULATIONS

2.4 PAYMENT ARRANGEMENTS AND CREDIT ALLOWANCES

2.4.1 PAYMENT OF RATES, CHARGES AND DEPOSITS

B.2.b. (Cont'd)

- (1) The highest interest rate (in decimal value) which may be levied by law for commercial transactions, compounded daily for the number of days from the payment date to and including the date that the customer actually makes the payment to the Company, or
 - (2) 0.000407 per day, compounded daily for the number of days from the payment date to and including the date that the customer actually makes the payment to the Company.
- c. In the event of a billing dispute, the customer must submit a documented claim for the disputed amount. If the claim is submitted within ninety (90) days of the payment due date, any interest credits due the customer upon resolution of the dispute shall be calculated from the bill payment date. If the customer submits a claim for the disputed amount more than ninety (90) days from the payment due date, any interest credits due the customer upon resolution of the dispute shall be calculated from the later of the date the claim was submitted, or the bill payment due. Any undisputed amounts withheld by the customer in conjunction with disputed amounts withheld, shall be subject to the late payment penalty, as set forth in b., preceding. The Company will resolve the dispute and assess interest credits or penalties to the customer as follows:
- If the dispute is resolved in favor of the Company and the customer has paid the disputed amount on or before the payment due date, no interest credits or penalties will apply.
 - If the dispute is resolved in favor of the Company and the customer has withheld the disputed amount, any payments withheld pending settlement of the dispute shall be subject to the late payment penalty as set forth in b., preceding.
 - If the dispute is resolved in favor of the customer and the customer has withheld the disputed amount, no interest credits or penalties will apply.

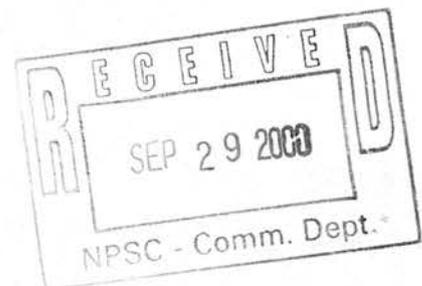

Qwest Corporation
Access Service
Catalog

SECTION 2

Page 35

Release 1

Effective: 9-29-2000

State of Nebraska
Notified: 9-29-2000

2. GENERAL REGULATIONS

2.4 PAYMENT ARRANGEMENTS AND CREDIT ALLOWANCES

2.4.1 PAYMENT OF RATES, CHARGES AND DEPOSITS

B.2.c. (Cont'd)

- If the dispute is resolved in favor of the customer and the customer has paid the disputed amount, the customer will receive an interest credit from the Company for the disputed amount times a late factor. The late factor shall be the lesser of:
 - (1) The highest interest rate (in decimal value, which may be levied by law for commercial transactions, compounded daily for the number of days from the date when payment was made or credit claimed in accordance with c., preceding, to and including the payment due date (as set forth in 2.a., preceding), of the bill that reflects the credit for the disputed amount. In the event that the Company agrees to refund a credit by check or wire transfer, interest will be applied up to and including the date of issuance for either the check or wire transfer.
 - (2) 0.000407 per day, compounded daily for the number of days from the date when payment was made or credit claimed in accordance with c., preceding, to and including the payment due date (as set forth in 2.a., preceding), of the bill that reflects the credit for the disputed amount. In the event that the Company agrees to refund a credit by check or wire transfer, interest will be applied up to and including the date of issuance for either the check or wire transfer.
- C. Adjustments for the quantities of services established or discontinued in any billing period beyond the minimum period set forth for services in other sections of this Catalog will be prorated to the number of days or major fraction of days based on a thirty (30) day month. The Company will, upon request and if available, furnish such detailed information as may reasonably be required for verification of any bill.
- D. When a rate as set forth in this Catalog is shown to more than two decimal places, the charges will be determined using the rate shown. The resulting amount will then be rounded to the nearest penny (i.e., rounded to two decimal places).
- E. When more than one copy of a customer bill for services provided under the provisions of this Catalog is furnished to the customer, an additional charge applies for each additional copy of the bill as set forth in 13.3.6, following.

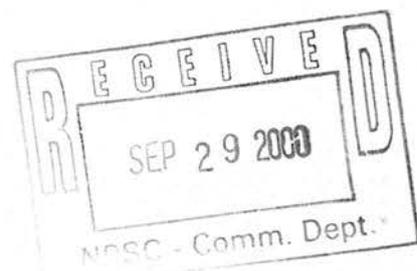

NOTICE

THE INFORMATION CONTAINED IN THIS DOCUMENT IS SUBJECT TO CHANGE.
NE2000-054

2. GENERAL REGULATIONS

2.4 PAYMENT ARRANGEMENTS AND CREDIT ALLOWANCES (Cont'd)

2.4.2 MINIMUM PERIODS

The minimum period for which services are provided and for which rates and charges are applicable is one month unless otherwise specified.

When a service is discontinued prior to the expiration of the minimum period, charges are applicable, whether the service is used or not, as follows:

- A. When a service with a one month minimum period is discontinued prior to the expiration of the minimum period, a one month charge will apply at the rate level in effect at the time service is discontinued.
- B. When a service with a minimum period greater than one month is discontinued prior to the expiration of the minimum period, the applicable charge will be the lesser of (1) the Company's total nonrecoverable costs less the net salvage value for the discontinued service or (2) the total monthly charges, at the rate level in effect at the time service is discontinued, for the remainder of the minimum period.

2.4.3 CANCELLATION OF AN ORDER FOR SERVICE

Provisions for the cancellation of an order for Switched Access are set forth in Section 5, following.

2.4.4 CREDIT ALLOWANCE FOR SERVICE INTERRUPTIONS

A. General

A service is interrupted when it becomes unusable to the customer because of a failure of facility component used to furnish service under this Catalog or in the event that the protective controls applied by the Company result in the complete loss of service by the customer as set forth in 6.5.1, following. An interruption period starts when an inoperative service is reported to the Company, and ends when the service is operative.

Reports of an inoperative service will be taken only from the customer of record for that particular service.

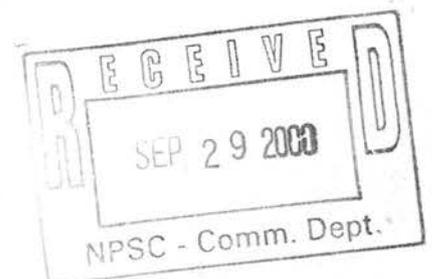

2. GENERAL REGULATIONS

2.4 PAYMENT ARRANGEMENTS AND CREDIT ALLOWANCES

2.4.4 CREDIT ALLOWANCE FOR SERVICE INTERRUPTIONS (Cont'd)

B. When a Credit Allowance Applies

1. For Switched Access Service (including CCSAC) and Directory Assistance Service other than Entrance Facilities and Direct-Trunked Transport Facilities, no credit shall be allowed for an interruption of less than 24 hours. The customer shall be credited for an interruption of 24 hours or more at the rate of 1/30 of (a) any applicable monthly rates or (b) the assumed minutes of use charge for each period of 24 hours or major fraction thereof that the interruption continues.
2. For Switched Access Entrance Facilities, Direct-Trunked Transport Facilities and any optional multiplexing arrangements associated with such facilities, no credit shall be allowed for an interruption of less than 30 minutes. The customer shall be credited for an interruption of 30 minutes or more at the rate of 1/1440 of the monthly charges for each period of 30 minutes or major fraction thereof that the interruption continues. The monthly charge shall be the total of all the monthly rate element charges associated with that portion of the service (i.e., Entrance Facility, Direct-Trunked Transport Facility and Multiplexer) that is inoperative.
3. The credit allowance(s) for an interruption or for a series of interruptions shall not exceed (a) any applicable monthly rates or (b) the assumed minutes of use charge for the service interrupted in any one monthly billing period.
4. Service interruptions for Specialized Service or Arrangements provided under the provisions of Section 12, following, shall be administered in the same manner as those set forth in this 2.4.4, unless other regulations are specified with the individual case filing.
5. For Expanded Interconnection Service, no credit shall be allowed for an interruption of the EICT of less than four hours. The customer shall be credited for an interruption of four hours or more at the rate of 1/180 of the monthly charges for only the Expanded Interconnection Channel Terminations for each period of four hours or major fraction thereof that the interruption continues.

C. When Credit Allowances Does Not Apply

No credit allowance will be made for:

1. Interruptions caused by the negligence of the customer.
2. Interruptions of a service due to the failure of equipment or systems provided by the customer or others.
3. Interruptions of a service during any period in which the Company is not afforded access to the premises where the service is terminated.

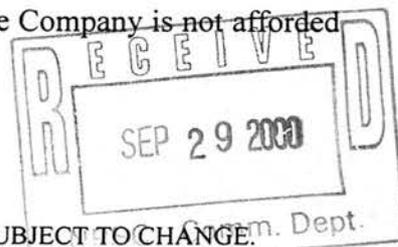

NOTICE

2. GENERAL REGULATIONS

2.4 PAYMENT ARRANGEMENTS AND CREDIT ALLOWANCES

2.4.4 CREDIT ALLOWANCE FOR SERVICE INTERRUPTIONS

C. When Credit Allowances Does Not Apply (Cont'd)

4. Interruptions of a service when the customer has released that service to the Company for maintenance purposes, to make rearrangements, or for the implementation of an order for a change in the service during the time that was negotiated with the customer prior to the release of that service. Thereafter, a credit allowance as set forth in B., preceding, applies.
5. Interruptions of a service which continue because of the failure of the customer to authorize replacement of any element of special construction, as set forth in the 5.1.3, following. The period for which no credit allowance is made begins on the seventh day after the customer receives the Company's written notification of the need for such replacement and ends on the day after receipt by the Company of the customer's written authorization for such replacement.
6. Periods when the customer elects not to release the service for testing and/or repair and continues to use it on an impaired basis.
7. Periods of temporary discontinuance as set forth in 2.2.1.B., preceding.
8. Periods of interruption as set forth in 13.3.1, following.
9. An interruption or a group of interruptions, resulting from a common cause, for amounts less than one dollar.

D. Use of an Alternative Service Provided by the Company

Should the customer elect to use an alternative service provided by the Company during the period that a service is interrupted, the customer must pay the rates and charges for the alternative service used.

E. Temporary Surrender of a Service

In certain instances, the customer may be requested by the Company to surrender a service for purposes other than maintenance, testing or activity relating to a service order. If the customer consents, a credit allowance will be granted. The credit allowance will be 1/1440 of the monthly rate for each period of 30 minutes or fraction thereof that the service is surrendered. In no case will the credit allowance exceed the monthly rate for the service surrendered in any one monthly billing period.

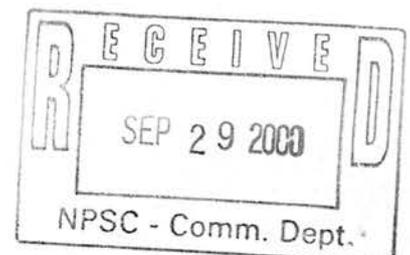

2. GENERAL REGULATIONS

2.4 PAYMENT ARRANGEMENTS AND CREDIT ALLOWANCES (Cont'd)

2.4.5 REESTABLISHMENT OF SERVICE FOLLOWING FIRE, FLOOD OR OTHER OCCURRENCE

A. Nonrecurring Charges Do Not Apply

Charges do not apply for reestablishment of service following a fire, flood or other occurrences attributed to an Act of God provided that:

1. The service is of the same type as was provided prior to the fire, flood or other occurrence.
2. The service is for the same customer.
3. The service is at the location on the same premises.
4. The reestablishment of service begins within 60 days after Company service is available. (The 60 day period may be extended a reasonable period if the renovation of the original location on the premises affected is not practical within the allotted time period.)

B. Nonrecurring Charges Apply

Nonrecurring charges apply for establishing service at a different location on the same premises or at a different premises pending reestablishment of service at the original location.

2.4.6 TITLE OR OWNERSHIP RIGHTS

The payment of rates and charges by customers for the services offered under the provisions of this Catalog does not assign, confer or transfer title or ownership rights to proposals or facilities developed or utilized, respectively, by the Company in the provision of such services.

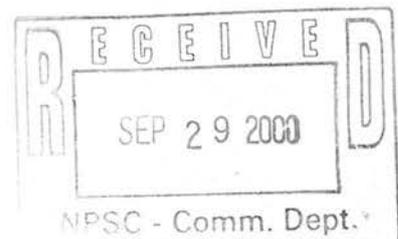

Qwest Corporation
Access Service
Catalog

SECTION 2

Page 40

Release 1

State of Nebraska
Notified: 9-29-2000

Effective: 9-29-2000

2. GENERAL REGULATIONS

2.4 PAYMENT ARRANGEMENTS AND CREDIT ALLOWANCES (Cont'd)

2.4.7 ORDERING, RATING AND BILLING OF ACCESS SERVICES WHERE MORE THAN ONE EXCHANGE TELEPHONE COMPANY IS INVOLVED

The Multiple Exchange Carriers Access Billing Guidelines (MECAB) and the Multiple Exchange Carriers Ordering and Design Guidelines (MECOD) are the standards on which the regulations in the following paragraphs are based. These standards determine the ordering, rating and billing for Access Services when the service is provided by more than one Exchange Telephone Company.

All information necessary for billing, ordering and design coordination will be provided based on the standards in the MECAB and MECOD guidelines to ensure that jointly provided Access Services are installed, tested and turned up in a timely manner.

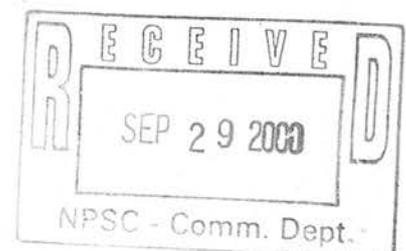

Qwest Corporation
Access Service
Catalog

SECTION 2
Page 41
Release 2

State of Nebraska
Notified: 05-30-2003

Effective: 06-10-2003

2. GENERAL REGULATIONS

2.4 PAYMENT ARRANGEMENTS AND CREDIT ALLOWANCES

2.4.7 ORDERING, RATING AND BILLING OF ACCESS SERVICES WHERE MORE THAN ONE EXCHANGE TELEPHONE COMPANY IS INVOLVED (Cont'd)

A. Feature Group A Switched Access Service

1. The ordering, rating, and billing of Feature Group A Switched Access Service will be based on revenue-sharing agreements between the Exchange Carriers jointly providing the service. (T)
2. For Feature Group A Switched Access Service, the Exchange Telephone Company in whose territory the first point of switching is located will accept the order. In addition, the Exchange Telephone Company in whose territory the customer's POT is located must also receive a copy of the order from the customer. (T)
3. The Exchange Telephone Company that accepts the order will then determine the charges involved, arrange to provide the Access Service ordered and bill the charges in accordance with its Access Service tariff/catalog.

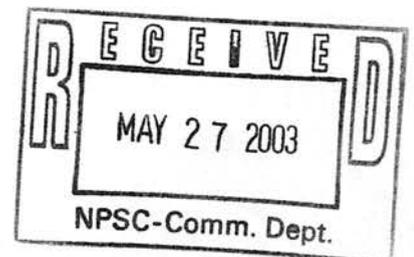

Qwest Corporation
Access Service
Catalog

SECTION 2

Page 42

Release 2

State of Nebraska
Notified: 05-30-2003

Effective: 06-10-2003

2. GENERAL REGULATIONS

2.4 PAYMENT ARRANGEMENTS AND CREDIT ALLOWANCES

2.4.7 ORDERING, RATING AND BILLING OF ACCESS SERVICES WHERE MORE THAN ONE EXCHANGE TELEPHONE COMPANY IS INVOLVED (Cont'd)

- B. Feature Groups B, C and D Switched Access Service, and Directory Assistance Access Service

When more than one Exchange Telephone Company is involved in the provision of Access Service, the customer requesting initial service will be notified in writing at least 30 days prior to the initial billing date which Exchange Telephone Company's set of terms and conditions apply, and of the billing arrangement for any jointly provided Access Service ordered. Customers requesting additional service will not be notified unless a change in the existing billing arrangement is made. In the event of a change in the existing billing arrangement, the customer will be notified in writing at least 30 days prior to the date when the Exchange Telephone Companies involved in the provision of Access Service agree to change from one billing arrangement to another. Notification will also include the customer's method of payment.

(T)

(T)

1. Each Exchange Telephone Company involved shall receive a copy of the order. The Exchange Telephone Company that accepts the order and/or bills the customer is determined as follows:

(T)

- a. FGB, FGC and FGD Ordered to an End Office

The Exchange Telephone Company where the end office is located and will accept the order and bill the customer.

(T)

- b. FGB, FGC and FGD Ordered to an Access Tandem

The Exchange Telephone Company that owns the access tandem will accept the order. The Exchange Telephone Company that owns the end office(s) that subtend the access tandem will bill the customer.

(T)

- c. Voice DA

The Exchange Telephone Company where the Directory Assistance bureau is located will accept the order and bill the customer.

(T)

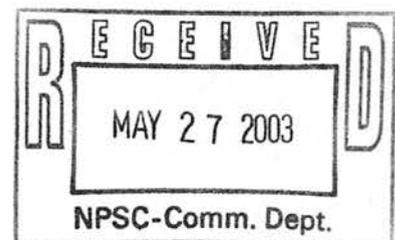

NOTICE

THE INFORMATION CONTAINED IN THIS DOCUMENT IS SUBJECT TO CHANGE.
NE2003-025

Qwest Corporation
Access Service
Catalog

SECTION 2
Page 43
Release 2

State of Nebraska
Notified: 05-30-2003

Effective: 06-10-2003

2. GENERAL REGULATIONS

2.4 PAYMENT ARRANGEMENTS AND CREDIT ALLOWANCES

2.4.7 ORDERING, RATING AND BILLING OF ACCESS SERVICES WHERE MORE THAN ONE EXCHANGE TELEPHONE COMPANY IS INVOLVED

B. Feature Groups B, C and D Switched Access Service, and Directory Assistance Access Service (Cont'd)

2. Upon agreement between the Exchange Telephone Companies involved, a single bill will be rendered to the customer. The Exchange Telephone Company rendering the bill is the Exchange Telephone Company as determined in 1., preceding. There are three single bill alternatives that the Exchange Telephone Companies may agree to provide and are described following:

(C)

There are payment options with Alternatives No. 1 and 2. In the first payment option, the Exchange Telephone Companies can require the customer to remit payment via a single check to the bill rendering Exchange Telephone Company. In the second payment option, the Exchange Telephone Companies can require the customer to remit payment via multiple checks to all of the Exchange Telephone Companies jointly provisioning the Access Service to the customer.

(N)

(N)

a. Alternative No. 1[1]

The Exchange Telephone Company that will render the single bill will separately identify the rates and charges for each Exchange Telephone Company involved. The billing Exchange Telephone Company will maintain and administer in its billing system the applicable rate and charges for all of the involved Exchange Telephone Companies. The Exchange Telephone Companies not rendering the single bill will provide the interpretation and application of their tariffs to the Billing Exchange Telephone Company.

b. Alternative No. 2[2]

The Exchange Telephone Company that will render the single bill will receive a prepared bill from each involved Exchange Telephone Company. For Switched Access and/or Voice DA Services, the billing Exchange Telephone Company will receive prepared bills without usage data. The billing Exchange Telephone Company will then apply usage data to the bills, calculate the charges and combine all of the bills into one bill. For usage rated services, the billing Exchange Telephone Company and the non-billing Exchange Telephone Company will use the same amount of usage on the bill.

[1] Also termed Single Bill - Multiple Tariff

[2] Also termed Single Bill - Pass Through

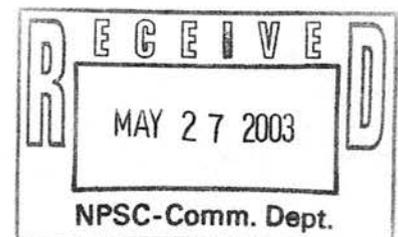

NOTICE

THE INFORMATION CONTAINED IN THIS DOCUMENT IS SUBJECT TO CHANGE.
NE2003-025

Qwest Corporation
Access Service
Catalog

SECTION 2

Page 44

Release 2

State of Nebraska
Notified: 05-30-2003

Effective: 06-10-2003

2. GENERAL REGULATIONS

2.4 PAYMENT ARRANGEMENTS AND CREDIT ALLOWANCES

2.4.7 ORDERING, RATING AND BILLING OF ACCESS SERVICES WHERE MORE THAN ONE EXCHANGE TELEPHONE COMPANY IS INVOLVED

B.2. (Cont'd)

c. Alternative No. 3[1]

The Exchange Telephone Company that will render the single bill will include in its rates and charges the costs of each Exchange Telephone Company involved and will bill for the entire Access Service(s) ordered. For usage-rated services, the billing Exchange Telephone Company and the non-billing Exchange Telephone Company will use the same amount of usage on the bill.

The rates and charges for each Exchange Telephone Company are based upon billing percentages. These billing percentages are agreed upon by each Exchange Telephone Company.

(T)

The customer will receive from the non-billing Exchange Telephone Company a written agency agreement authorizing payment to the billing Exchange Telephone Company.

3. If the Exchange Telephone Companies involved cannot agree upon a single bill alternative, then each Exchange Telephone Company will render a separate bill to the customer. This billing arrangement is described in 4., following.

[1] Also termed Single Bill - Single Tariff

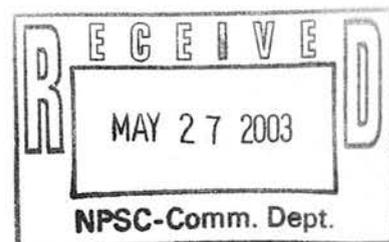

NOTICE

THE INFORMATION CONTAINED IN THIS DOCUMENT IS SUBJECT TO CHANGE.
NE2003-025

Qwest Corporation
Access Service
Catalog

SECTION 2

Page 45

Release 2

State of Nebraska
Notified: 05-30-2003

Effective: 06-10-2003

2. GENERAL REGULATIONS

2.4 PAYMENT ARRANGEMENTS AND CREDIT ALLOWANCES

2.4.7 ORDERING, RATING AND BILLING OF ACCESS SERVICES WHERE MORE THAN ONE EXCHANGE TELEPHONE COMPANY IS INVOLVED

B. Feature Groups B, C and D Switched Access Service, and Directory Assistance Access Service (Cont'd)

4. When the Exchange Telephone Companies involved agree to render separate bills the following regulations apply:
 - a. Each Exchange Telephone Company involved will accept the order from the customer.
 - b. Each Exchange Telephone Company will provide the portion of the Transport element in its operating territory and will bill the charges in accordance with its Access Service tariff. All other appropriate charges in each Exchange Telephone Company's tariff are applicable.
 - c. Each Exchange Telephone Company will render bills for nonrecurring charges as they are incurred. Bills for recurring charges will not be rendered until the service ordered can be provided by all of the Exchange Telephone Companies involved.
 - d. Each Exchange Telephone Company will determine the appropriate Transport charges by computing the airline mileage between the two ends of the Transport element using the V and H method as set forth in 6.7.11, following.
 - e. Each Exchange Telephone Company will determine the rate for the airline mileage determined in d., preceding, using the Company's Catalog. Multiply such rate by the Company's billing percentage factor and divide by 100 to obtain the Transport element charges.

(T)

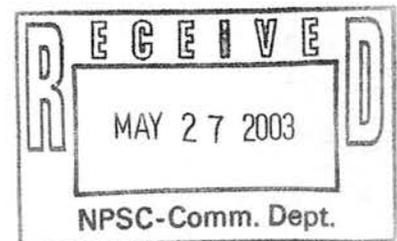

NOTICE

THE INFORMATION CONTAINED IN THIS DOCUMENT IS SUBJECT TO CHANGE.
NE2003-025

Qwest Corporation d/b/a CenturyLink QC
Access Service
Catalog

SECTION 2
Page 46
Release 2
Effective: 07-01-2017

(C)

State of Nebraska
Notified: 06-07-2017

2. GENERAL REGULATIONS

2.4 PAYMENT ARRANGEMENTS AND CREDIT ALLOWANCES

2.4.7 ORDERING, RATING AND BILLING OF ACCESS SERVICES WHERE MORE THAN ONE EXCHANGE TELEPHONE COMPANY IS INVOLVED (Cont'd)

C. The billing percentages will be agreed upon by the Exchange Telephone Companies involved.

D. When jointly provisioned Switched Access Service is provided between the Company and another Exchange Telephone Company, the appropriate Switched Access recurring rates will be applied based on the type of Switched Transport provided, Tandem-Switched Transport (TST) or Direct-Trunked Transport (DTT). Tandem 3rd Party rates apply to Terminating Traffic Types between the Company and another Exchange Telephone Company that is not a CenturyLink Operating Company (CLOC) ILEC

(C)

(C)

(C)

For Switched Access Service provisioned as TST, the appropriate Switched Access recurring rates for Terminating – Tandem 3rd Party or Originating will be applied as follows: 1) multiply the Tandem Transmission fixed rate by the minutes of use (MOU) by the billing percentage (BP), 2) multiply the Tandem Transmission per-mile rate by the number of miles, by the MOU by the BP, and 3) all other appropriate Switched Access recurring rate elements at 100 percent, if applicable.

(C)

For Switched Access Service provisioned as DTT, the recurring rates will be applied as follows: 1) multiply the monthly Transport Channel fixed rate by the BP, 2) multiply the monthly Transport Channel per-mile rate by the number of miles, by the BP, and 3) all other appropriate Switched Access recurring rate elements at 100 percent, if applicable.

The Exchange Telephone Company that owns the access tandem will assess the appropriate access tandem Terminating – Tandem 3rd Party or Originating recurring rates at 100 percent. The Exchange Telephone Company that owns the end office will assess the appropriate end office recurring rates at 100 percent.

(C)

NOTICE

THE INFORMATION CONTAINED IN THIS DOCUMENT IS SUBJECT TO CHANGE.

NE2017-006

Qwest Corporation d/b/a CenturyLink QC

**Access Service
Catalog**

SECTION 2
Page 47
Release 2
Effective: 07-01-2017

(C)

State of Nebraska
Notified: 06-07-2017

2. GENERAL REGULATIONS

2.4 PAYMENT ARRANGEMENTS AND CREDIT ALLOWANCES

2.4.7 ORDERING, RATING AND BILLING OF ACCESS SERVICES WHERE MORE THAN ONE EXCHANGE TELEPHONE COMPANY IS INVOLVED (Cont'd)

- E. When jointly provisioned Switched Access Service is provided and the Company is the intermediate non-terminating carrier, only the recurring Tandem Transmission per-mile rate for Terminating – Tandem 3rd Party or Originating or DTT per-mile rate for Switched Access Service or the recurring CMV rate for Private Line Transport service will apply. The Tandem Transmission Originating per-mile rate or Tandem Transmission Terminating– Tandem 3rd Party per-mile rate or DTT per-mile rate will be determined by multiplying the appropriate rate by the MOU by the number of miles, by the BP. The DTT per-mile rate will be determined by multiplying the appropriate DTT per-mile monthly rate by the number of miles by the BP. If the Company provides the access tandem, all appropriate access tandem 3rd Party recurring rates will apply at 100 percent.
- F. When jointly provisioned Access Service is provided between the Company and another Exchange Telephone Company, or when the Company is the intermediate non-terminating carrier, the appropriate nonrecurring charges shall apply. The BP is not applied to nonrecurring charges.

(C)

(C)

(C)

NOTICE

THE INFORMATION CONTAINED IN THIS DOCUMENT IS SUBJECT TO CHANGE.

NE2017-006

2. GENERAL REGULATIONS

2.4 PAYMENT ARRANGEMENTS AND CREDIT ALLOWANCES

2.4.7 ORDERING, RATING AND BILLING OF ACCESS SERVICES WHERE MORE THAN ONE EXCHANGE TELEPHONE COMPANY IS INVOLVED (Cont'd)

G. Examples - Switched Access provisioned by Direct-Trunked Transport and Tandem-Switched Transport (T)

Feature Group D Access Service Ordered

Example 1

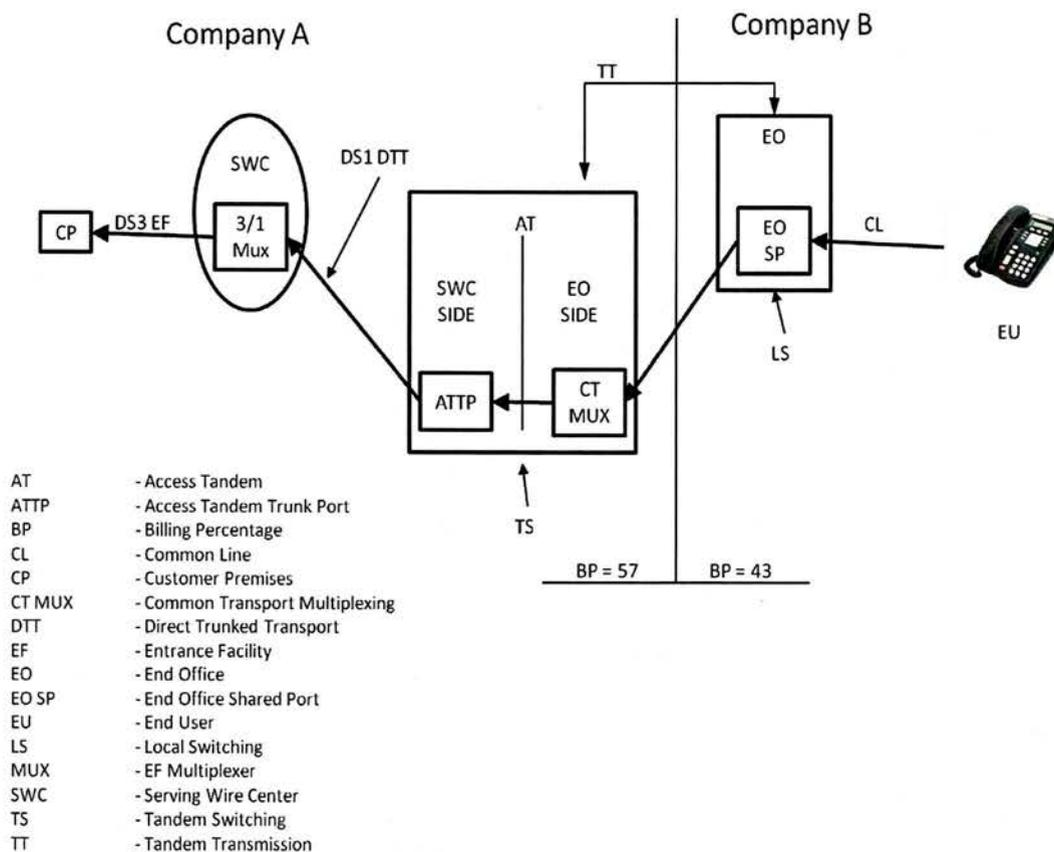

Qwest Corporation d/b/a CenturyLink QC

**Access Service
Catalog**

SECTION 2
Page 49
Release 2
Effective: 07-01-2017

(C)

State of Nebraska
Notified: 06-07-2017

2. GENERAL REGULATIONS

2.4 PAYMENT ARRANGEMENTS AND CREDIT ALLOWANCES

2.4.7 ORDERING, RATING AND BILLING OF ACCESS SERVICES WHERE MORE THAN ONE EXCHANGE TELEPHONE COMPANY IS INVOLVED

G. Examples - Switched Access provisioned by Direct-Trunked Transport and Tandem-Switched Transport (Cont'd) (T)

1. Example 1 Layout (C)

a. Originating Feature Group D Switched Access is ordered to an end office via DTT and TST. Originating rates would apply. (C)

b. The premises of ordering customer, the serving wire center (SWC) of that premises, and the access tandem are in operating territory of Company A. (C)

c. The customer orders a DS3 Entrance Facility from the customer's premises to the SWC with a 3/1 MUX in the SWC.

d. The customer orders a DS1 DTT to the AT.

e. The BP for TT is 57 for Company A.

f. The end office is in the operating territory of Company B.

g. The BP for transport is 43 for Company B.

2. Rate elements assessed per Company

a. Company A (C)

Entrance Facility - 100% of DS3 monthly Entrance Facility rate and 3/1 MUX

DS1 DTT - 100% of DS1 monthly DTT rate

ATTP - 100% of ATTP monthly rate

Tandem Switching - MOU rate X MOU

Common Transport MUX - MOU rate X MOU

Tandem Transmission - Fixed rate X MOU X BP

Tandem Transmission - Per-mile rate X number of miles X MOU X BP

(C)
|
(C)

NOTICE

THE INFORMATION CONTAINED IN THIS DOCUMENT IS SUBJECT TO CHANGE.

Qwest Corporation d/b/a CenturyLink QC
Access Service
Catalog

SECTION 2
 Page 49.1
 Release 1
 Effective: 07-01-2017

State of Nebraska
 Notified: 06-07-2017

2. GENERAL REGULATIONS

2.4 PAYMENT ARRANGEMENTS AND CREDIT ALLOWANCES

2.4.7 ORDERING, RATING AND BILLING OF ACCESS SERVICES WHERE MORE THAN ONE EXCHANGE TELEPHONE COMPANY IS INVOLVED

G. Examples - Switched Access provisioned by Direct-Trunked Transport and Tandem-Switched Transport

2. Rate elements assessed per Company (Cont'd)

b. Company B

- Tandem Transport - Transport rate X MOU X BP
- Local Switching - MOU rate X MOU
- End Office Shared Port - MOU rate X MOU
- Carrier Common Line - MOU rate X MOU

(C)
 (C-M)
 (M)
 (N)

Feature Group D Access Service Ordered

Example 2

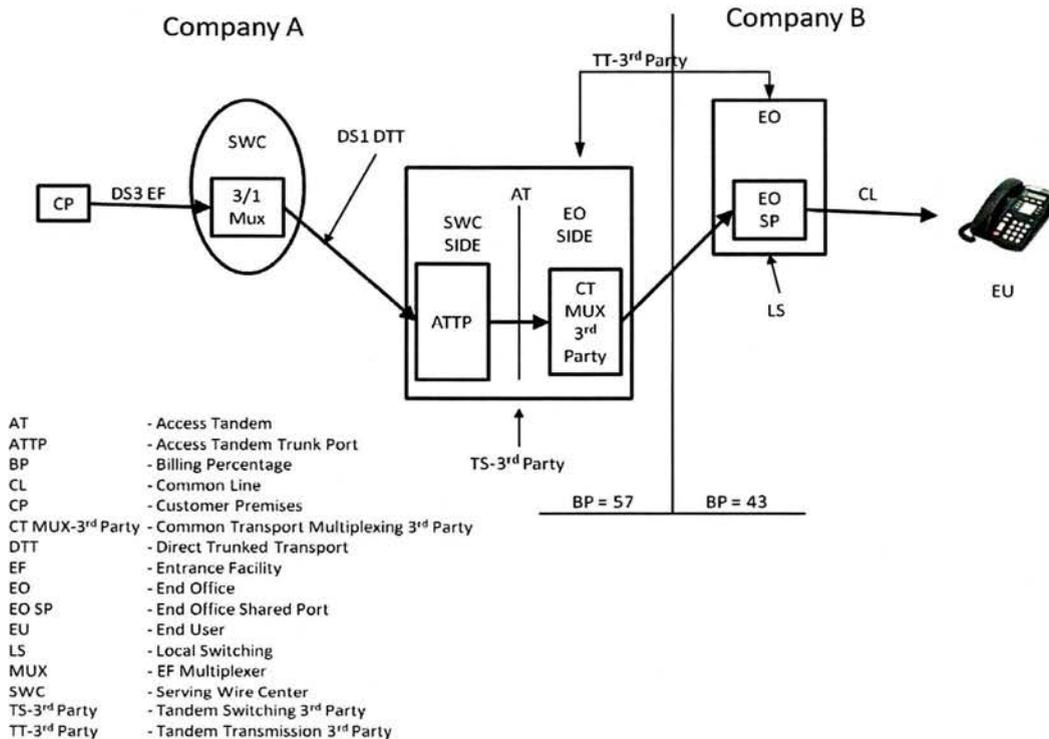

(M) Material moved from Page 50.

Qwest Corporation d/b/a CenturyLink QC

**Access Service
Catalog**

SECTION 2

Page 49.2

Release 2

Effective: 3-12-2018

State of Nebraska
Notified: 3-2-2018

2. GENERAL REGULATIONS

2.4 PAYMENT ARRANGEMENTS AND CREDIT ALLOWANCES

2.4.7 ORDERING, RATING AND BILLING OF ACCESS SERVICES WHERE MORE THAN ONE EXCHANGE TELEPHONE COMPANY IS INVOLVED

G. Examples - Switched Access provisioned by Direct-Trunked Transport and Tandem-Switched Transport (Cont'd)

3. Example 2 Layout

- a. Terminating Feature Group D Switched Access is ordered to an end office via DTT & TST. Terminating – Tandem 3rd Party rates would apply.
- b. The premises of ordering customer, the serving wire center (SWC) of that premises, and the access tandem are in operating territory of Company A.
- c. The customer orders a DS3 Entrance Facility from the customer's premises to the SWC with a 3/1 Mux in the SWC.
- d. The customer orders a DS1 DTT to the AT.
- e. The BP for TT is 57 for Company A.
- f. Company B is not a CLOC ILEC.
- g. The end office is in the operating territory of Company B.
- h. The BP for transport is 43 for Company B.

(T)

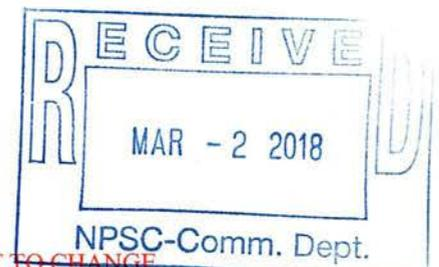

NOTICE

THE INFORMATION CONTAINED IN THIS DOCUMENT IS SUBJECT TO CHANGE.

Qwest Corporation d/b/a CenturyLink QC
Access Service
Catalog

SECTION 2
 Page 49.3
 Release 1
 Effective: 07-01-2017

State of Nebraska
 Notified: 06-07-2017

2. GENERAL REGULATIONS

2.4 PAYMENT ARRANGEMENTS AND CREDIT ALLOWANCES

2.4.7 ORDERING, RATING AND BILLING OF ACCESS SERVICES WHERE MORE THAN ONE EXCHANGE TELEPHONE COMPANY IS INVOLVED

G. Examples - Switched Access provisioned by Direct-Trunked Transport and Tandem-Switched Transport (Cont'd)

Feature Group D Access Service Ordered

Example 3

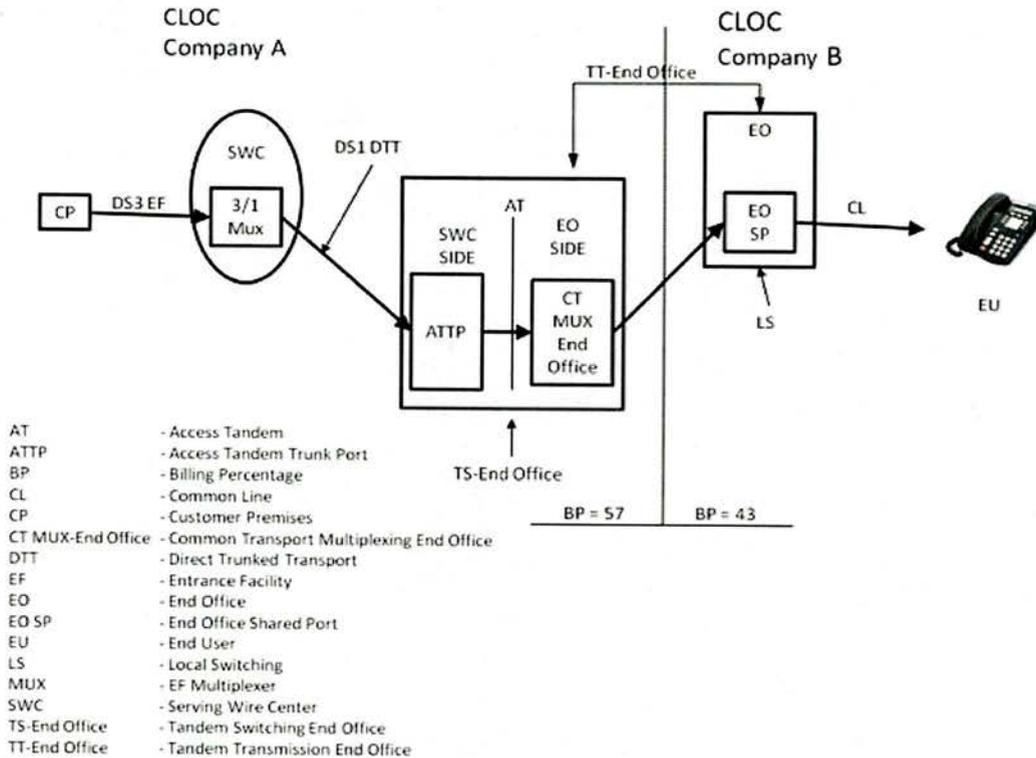

(N)

(N)

Qwest Corporation d/b/a CenturyLink QC

**Access Service
Catalog**

**SECTION 2
Page 49.4
Release 1**

State of Nebraska
Notified: 06-07-2017

Effective: 07-01-2017

2. GENERAL REGULATIONS

2.4 PAYMENT ARRANGEMENTS AND CREDIT ALLOWANCES

2.4.7 ORDERING, RATING AND BILLING OF ACCESS SERVICES WHERE MORE THAN ONE EXCHANGE TELEPHONE COMPANY IS INVOLVED

G. Examples - Switched Access provisioned by Direct-Trunked Transport and Tandem-Switched Transport (Cont'd)

4. Example 3 Layout

- a. Terminating Feature Group D Switched Access is ordered to an end office via DTT & TST. Terminating – Tandem End Office rates would apply
- b. The premises of ordering customer, the serving wire center (SWC) of that premises, and the access tandem are in operating territory of Company A.
- c. The customer orders a DS3 Entrance Facility from the customer's premises to the SWC with a 3/1 Mux in the SWC.
- d. The customer orders a DS1 DTT to the AT.
- e. The BP for TT is 57 for Company A.
- f. Company B is a CLOC ILEC.
- g. The end office is in the operating territory of Company B.
- h. The BP for transport is 43 for Company B.

(N)

(N)

NOTICE

THE INFORMATION CONTAINED IN THIS DOCUMENT IS SUBJECT TO CHANGE.

2. GENERAL REGULATIONS

2.4 PAYMENT ARRANGEMENTS AND CREDIT ALLOWANCES

2.4.7 ORDERING, RATING AND BILLING OF SWITCHED ACCESS SERVICES WHERE MORE THAN ONE EXCHANGE TELEPHONE COMPANY IS INVOLVED (Cont'd)

(M)

2.4.8 ORDERING, RATING AND BILLING OF SWITCHED ACCESS PROVIDED IN CONJUNCTION WITH A COMMERCIAL MOBILE RADIO SERVICE PROVIDER

When Switched Access Service is ordered by a customer in conjunction with a Commercial Mobile Radio Service provider, the Company will provide its portion of the Switched Access Service based on the regulations, rates and charges contained in its Access Service Catalog, subject to the following rules.

If the Company and the Commercial Mobile Radio Service provider have agreed to jointly provide the Switched Access Service, the Meet Point Billing provisions as set forth in 2.4.7, preceding, shall determine the ordering, rating and billing for access services.

If the Company and the Commercial Mobile Radio Service provider have not agreed to jointly provide the Switched Access Service under the provisions of Meet Point Billing, the Company shall provide the Switched Access Service to the carrier subject to the following rules.

- If the Company provides the Switched Transport and provides end office local switching functions, the customer will be assessed all applicable Switched Access Service rates (i.e., Switched Transport and Local Switching). Carrier Common Line rates will not be assessed.
- If the Company provides the Switched Transport and does not provide end office local switching functions, the Company will assess all applicable Switched Access charges, including the Switched Transport Tandem 3rd Party charges.

(C)
(C)

The mileage to be used to determine the Switched Transport rate is calculated as set forth in 6.7.11, following.

(M) Material moved to Page 49.1.

Qwest Corporation
Access Service
Catalog

SECTION 2

Page 51

Release 1

State of Nebraska
Notified: 9-29-2000

Effective: 9-29-2000

2. GENERAL REGULATIONS

2.5 CONNECTIONS

2.5.1 GENERAL

Equipment and Systems (i.e., terminal equipment, multiline terminating systems and communications systems) may be connected with Switched Access Service furnished by the Company where such connection is made in accordance with the provisions specified in Technical Reference Publication AS No. 1 and in 2.1, preceding.

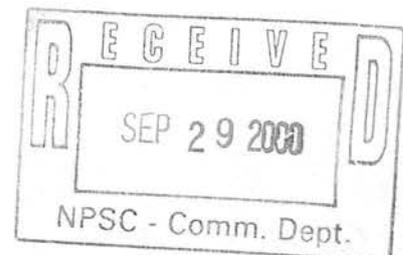

2. GENERAL REGULATIONS

2.6 DEFINITIONS

Certain terms used herein are defined as follows:

Access Code

A uniform seven digit code assigned by the Company to an individual customer. The seven digit code has the form 950-XXXX or 101XXXX.

Access Minutes

That usage of exchange facilities in intrastate or foreign service for the purpose of calculating chargeable usage. On the originating end of an intrastate or foreign call, usage is measured from the time the originating end user's call is delivered by the Company to and acknowledged as received by the customer's facilities connected with the originating exchange. On the terminating end of an intrastate or foreign call, usage is measured from the time the call is received by the end user in the terminating exchange. Timing of usage at both originating and terminating ends of an intrastate or foreign call shall terminate when the calling or called party disconnects, whichever event is recognized first in the originating and terminating exchanges, as applicable.

Access Service Group (ASG)

A group of like access services ordered to an end office or access tandem switch (for Feature Groups B, C or D) or to a dial tone office.

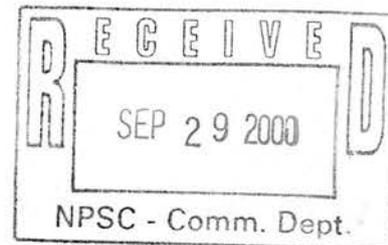

2. GENERAL REGULATIONS

2.6 DEFINITIONS (Cont'd)

Access Tandem (AT)

A Company switching system that provides a concentration and distribution function for originating or terminating traffic between end offices and the customer's point of termination.

Access Transport Parameter (ATP)

The SS7 Out of Band Signaling parameter which provides the automatic transmission of information from the originating calling location through the Common Channel Signaling Network. Information supplied using ATP may consist of one or more of the following: Called Party Subaddress; Calling Party Subaddress; High and Low Layer Compatibility and Compatibility Checking by the called party's equipment.

Agent

Any individual, corporation, or other entity who an end user or location provider designates to act on its behalf before the Company whether in conjunction with the selection of a primary IC or in conjunction with other matters pertaining to the end user's or location provider's service.

Answer/Disconnect Supervision

The transmission of the switch trunk equipment supervisory signal (off-hook or on-hook) to the customer's point of termination as an indication that the called party has answered or disconnected.

Attenuation Distortion

The difference in loss at specified frequencies relative to the loss at 1004 Hz, unless otherwise specified.

Automatic Number Identification (ANI)

The automatic transmission of information digits and a seven or ten digit number to the customer's premises for calls originating in the LATA, to identify the calling station.

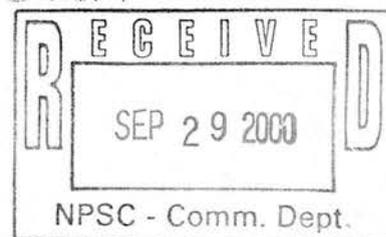

2. GENERAL REGULATIONS

2.6 DEFINITIONS (Cont'd)

Balance (100 Type) Test Line

An arrangement in an end office which provides for balance and noise testing.

Bit

The smallest unit of information in the binary system of notation.

Business Day

The times of day that a company is open for business. Generally, in the business community, these are 8:00 or 9:00 A.M. to 5:00 or 6:00 P.M., respectively, with an hour for lunch, Monday through Friday, resulting in a standard forty (40) hour work week. However, Business Day hours for the Company may vary based on company policy, union contract and location. To determine such hours for an individual company, or company location, that company should be contacted at the address shown under the Issuing Carrier's name listed on Title Page preceding or shown under the Concurring Carrier's name listed subsequent to the Table of Contents.

Busy Hour Minutes of Capacity (BHMC)

The customer specified maximum amount of Switched Access Service and/or Voice DA Service access minutes the customer expects to be handled in an end office switch during any hour in an 8:00 A.M. to 11:00 P.M. period for the Switched Access Service and/or Voice DA Service ordered.

Calendar Day

The days of the year from January 1 through December 31. When utilized in conjunction with determination of Standard Intervals, it denotes any day between January 1 through December 31 including Holidays.

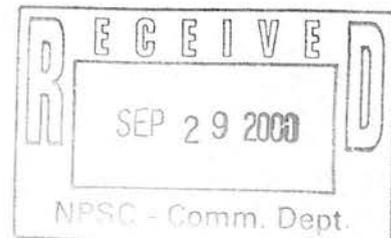

2. GENERAL REGULATIONS

2.6 DEFINITIONS (Cont'd)

Call

A customer attempt for which the complete address code (e.g., 0-, 911, or 10 digits) is provided to the serving dial tone office.

Calling Party Number (CPN)

The SS7 Out of Band Signaling parameter which automatically transmits the calling party's ten digit telephone number to the customer's premises for calls originating in the LATA.

Carrier or Common Carrier

See "Interexchange Carrier".

Carrier Selection Parameter (CSP)

The SS7 Out of Band Signaling parameter which identifies whether the dialing end user accessed the customer's network through a presubscribed line or by dialing the customer's 101XXXX code.

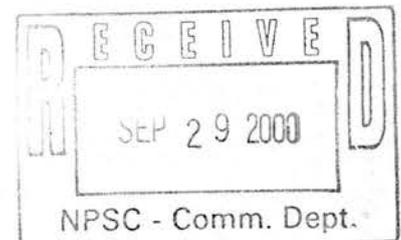

2. GENERAL REGULATIONS

2.6 DEFINITIONS (Cont'd)

CCS

A hundred call seconds, which is a standard unit of traffic load that is equal to 100 seconds of usage or capacity of a group of servers (e.g., trunks).

Central Office (CO)

A local Company switching system located at a wire center where Telephone Exchange Service customer station loops are terminated for purposes of interconnection to each other and to trunks.

Central Office Prefix

The first three digits (NXX) of the seven digit telephone number assigned to a customer's telephone exchange service when dialed on a local basis.

Centralized Automatic Reporting on Trunks (CAROT) Testing

A type of testing which includes the capacity for measuring operational and transmission parameters.

Channel(s)

An electrical or photonic, in the case of fiber optic-based transmission systems, communications path between two or more points of termination.

Channelize

The process of multiplexing wider bandwidth or higher speed channels into narrower bandwidth or lower speed channels or vice versa.

Charge Number (CN)

The SS7 Out of Band Signaling parameter which is equivalent to the ten digit ANI telephone number.

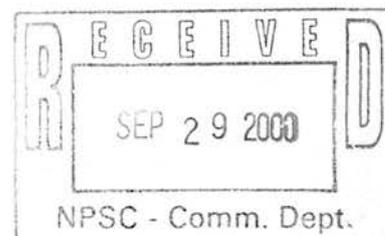

2. GENERAL REGULATIONS

2.6 DEFINITIONS (Cont'd)

C-Message Noise

The frequency weighted short term average noise within an idle voice channel. The frequency weighting, called C-message, is used to account for the variations in 500-type telephone set transducer efficiency and user annoyance, to tones as a function of frequency.

C-Notched Noise

The C-message frequency weighted noise on a voice channel with a holding tone, which is removed at the measuring end through a notch (very narrow band) filter.

Commercial Mobile Radio Service (CMRS) Provider

A common carrier as defined by the Federal Communications Commission subject to the Rules set forth in Section 332 of the Communications Act.

Common Channel Signaling Access Capability (CCSAC)

The interconnection between the Company's CCSN and a customer's CCSN.

Common Channel Signaling Network (CCSN)

A specialized digital signaling network separate from the regular message (voice) network which interconnects computerized switching systems and has access to special data bases.

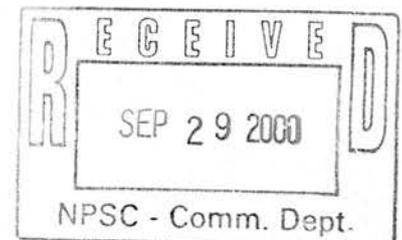

2. GENERAL REGULATIONS

2.6 DEFINITIONS (Cont'd)

Common Line

A line, trunk or other facility provided under Exchange and Network Services catalogs of the Company, terminated on a central office switch. A common line-residence is a line or trunk provided under the residence regulations of the Exchange and Network Services catalogs. A common line-business is a line provided under the business regulations of Exchange and Network Services catalogs.

Communications Systems

Channels and other facilities which are capable of communications between terminal equipment provided by other than the Company.

Customer(s)

Any individual, partnership, association, joint-stock company, trust, corporation, governmental entity or any other entity which subscribes to the services offered under this Catalog, including both Interexchange Carriers (ICs) and end users.

Data Transmission (107 Type) Test Line

An arrangement which provides for a connection to a signal source which provides test signals for one-way testing of data and voice transmission parameters.

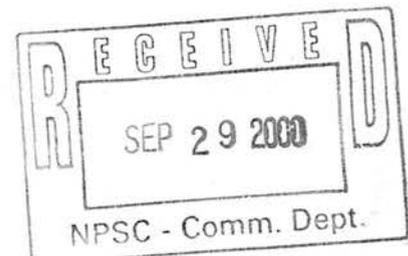

2. GENERAL REGULATIONS

2.6 DEFINITIONS (Cont'd)

Decibel (dB)

A unit of signal power used to express the relationship between two signal powers usually between acoustic, electric or optical signals, equal to ten (10) times the common logarithm of the ratio of two signal powers.

Decibel milliwatt (dBm)

A unit for expression of power level in decibels relative to one milliwatt.

Decibel Reference noise (dBm)

A unit used to express noise power relative to one picowatt (-90 dBm).

Decibel Reference Noise C-Message Referenced to 0 (dBmnc0)

Noise power in dBmnc referred to or measured at a zero transmission level point (OTLP).

Decibel Reference Noise C-Message Weighting (dBmnc)

Noise power in dBmnc measured with C-Message weighting.

Detail Billing

The listing of each message and/or rate element for which charges to a customer are due on a bill prepared by the Company.

Direct-Trunked Transport (DTT)

The transport between the SWC of the customer's premises and a Company end office, Company Hub or Company access tandem or between a Company Hub and a Company end office or Company access tandem on circuits dedicated to the use of a single customer, without switching at the Company access tandem.

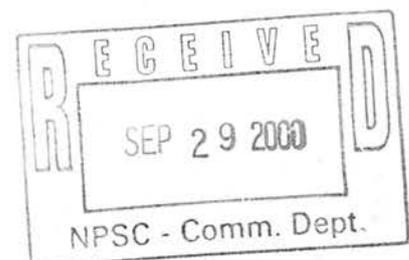

2. GENERAL REGULATIONS

2.6 DEFINITIONS (Cont'd)

Directory Assistance (DA)

See "Voice Directory Assistance" Access Service".

(C)

Directory Assistance Location

See "Voice Directory Assistance Location".

Dual Tone Multifrequency (DTMF) Address Signaling

A type of signaling that is an optional feature of Switched Access Feature Group A. It may be utilized when Feature Group A is being used in the terminating direction (from the point of termination with the customer to the local exchange end office). An office arranged for Dual Tone Multifrequency Signaling would expect to receive address signals from the customer in the form of Dual Tone Multifrequency signals.

Echo Control

The control of reflected signals in a telephone transmission path.

Echo Path Loss (EPL)

The measure of reflected signal at a 4-wire point of termination without regard to the send and receive Transmission Level Point.

Echo Return Loss (ERL)

A frequency weighted measure of return loss over the middle of the voiceband (approximately 500 to 2500 Hz), where talker echo is most annoying.

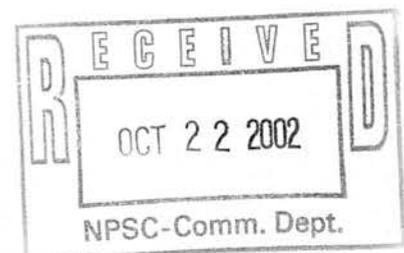

2. GENERAL REGULATIONS

2.6 DEFINITIONS (Cont'd)

Effective 2-Wire

A condition which permits the simultaneous transmission in both directions over a channel, but it is not possible to insure independent information transmission in both directions. Effective 2-wire channels may be terminated with 2-wire or 4-wire interfaces.

Effective 4-Wire

A condition which permits the simultaneous independent transmission of information in both directions over a channel. The method of implementing effective 4-wire transmission is at the discretion of the Company (physical, time domain, frequency-domain separation or echo cancellation techniques). Effective 4-wire channels may be terminated with a 2-wire interface at the customer's premises. However, when terminated 2-wire, simultaneous independent transmission cannot be supported because the two wire interface combines the transmission paths into a single path.

800 Data Base Access Service

Denotes a toll-free originating Trunkside Access Service when the 8XX Service Access Code (i.e., 800, 822, 833, 844, 855, 866, 877 or 888 as available) is used. The **terms 8XX and 8YY are** used interchangeably with 800 Data Base Access Service throughout this Catalog to describe this service.

(C)

8XX Service Provider

A telecommunications company, including Exchange and Interexchange Carriers, that offers 8XX Service to subscribers.

End Office Switch

A local Company switching system where telephone exchange service customer station loops are terminated for purposes of interconnection to trunks. Included are Remote Switching Modules and Remote Switching Systems served by a host office in a different wire center.

2. GENERAL REGULATIONS

2.6 DEFINITIONS (Cont'd)

End User (EU)

Any customer of an interstate, intrastate, or foreign telecommunications service that is not a carrier, except that a carrier (other than a telephone company) shall be deemed to be an "end user" when such carrier uses a telecommunications service for administrative purposes and a person or entity that offers telecommunications services exclusively as a reseller shall be deemed to be an "end user" if all resale transmission offered by such reseller originates or terminates on the premises of such reseller.

Entrance Facility (EF)

The dedicated Switched Access transport facility from the customer's premises or point of demarcation to the Company SWC.

Entry Switch

See "First Point of Switching".

Envelope Delay Distortion (EDD)

A measure of the linearity of the phase versus frequency of a channel.

Equal Level Echo Path Loss (ELEPL)

The measure of Echo Path Loss (EPL) at a 4-wire interface which is corrected by the difference between the send and receive Transmission Level Point (TLP). [ELEPL = EPL - TLP (send) + TLP (receive)].

Exchange

A unit generally smaller than a Local Access and Transport Area, established by the Company for the administration of communications service in a specified area which usually embraces a city, town or village and its environs. It consists of one or more central offices together with the associated facilities used in furnishing communications service within that area. The exchange includes any Extended Area Service (EAS) area that is an enlargement of a Company's exchange area to include nearby exchanges. One or more designated exchanges comprise a given Local Access and Transport Area.

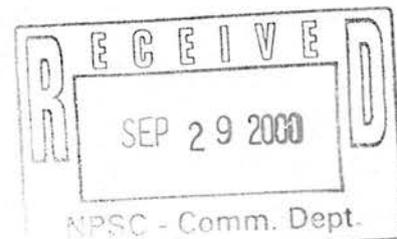

NOTICE

THE INFORMATION CONTAINED IN THIS DOCUMENT IS SUBJECT TO CHANGE.
NE2000-054

State of Nebraska
Notified: 03-20-2017

2. GENERAL REGULATIONS

2.6 DEFINITIONS (Cont'd)

Exit Message (EXM)

A SS7 message sent to an end office by the Company's access tandem switch to mark the carrier connect time when the Company's access tandem switch sends an Initial Address Message to the IC.

Expected Measured Loss (EML)

A calculated loss which specifies the end-to-end 1004 Hz loss on a terminated test connection between two readily accessible manual or remote test points. It is the sum of the inserted connection loss and test access loss including any test pads.

Extended Area Service (EAS)

See definition of "Exchange".

(D)

(D)

First Come, First Served

A procedure followed when the first Access Service Request (ASR) received will be the first service order processed.

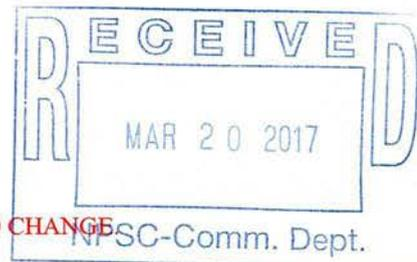

2. GENERAL REGULATIONS

2.6 DEFINITIONS (Cont'd)

First Point of Switching

The first Company location at which switching occurs on the terminating path of a call proceeding from the customer's premises to the terminating end office and, at the same time, the last Company location at which switching occurs on the originating path of a call proceeding from the originating end office to the customer's premises.

Frequency Shift

The change in the frequency of a tone as it is transmitted over a channel.

Grandfathered

Terminal equipment, multiline terminating systems and protective circuitry directly connected to the facilities utilized to provide services under the provisions of this Catalog, and which are considered grandfathered under Part 68 of the F.C.C.'s Rules and Regulations.

Host Office

An electronic switching system which provides call processing capabilities for one or more Remote Switching Modules or Remote Switching Systems.

Hub

A Company designated wire center at which bridging, multiplexing or connections to other services are performed (e.g., WATS Access Service, connections of two like services installed as two separate services).

(D)

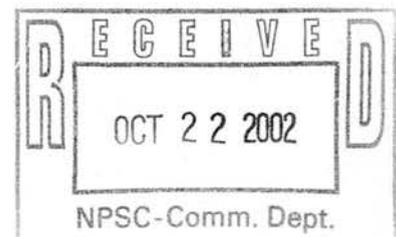

2. GENERAL REGULATIONS

2.6 DEFINITIONS (Cont'd)

Immediately Available Funds

A corporate or personal check drawn on a bank account and funds which are available for use by the receiving party on the same day on which they are received and include U.S. Federal Reserve bank wire transfers, U.S. Federal Reserve notes (paper cash), U.S. coins, U.S. Postal Money Orders and New York Certificates of Deposit.

Impedance Balance

The method of expressing Echo Return Loss and Singing Return Loss at a 4-wire interface whereby the gains and/or loss of the 4-wire portion of the transmission path, including the hybrid, are not included in the specification.

Impulse Noise

Any momentary occurrence of the noise on a channel over a specified level threshold. It is evaluated by counting the number of occurrences which exceed the threshold.

Individual Case Basis

A condition in which the regulations, if applicable, rate and charges for an offering under the provisions of this Catalog are developed based on the circumstances in each case.

Initial Address Message (IAM)

A SS7 signaling message that contains the address and routing information required to establish a point-to-point telephone connection.

Inserted Connection Loss

The 1004 Hz power difference (in dB) between the maximum power available at the originating end and the actual power reaching the terminating end through the inserted connection.

Integrated Service Digital Network User Part (ISUP)

A protocol that provides the mechanism for establishing the connections from the originating exchange to the destination exchange, without using the bearer circuit itself.

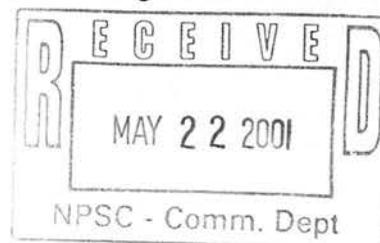

(N)

(N)

NOTICE

THE INFORMATION CONTAINED IN THIS DOCUMENT IS SUBJECT TO CHANGE.
NE2001-041

2. GENERAL REGULATIONS

2.6 DEFINITIONS (Cont'd)

Interexchange Carrier (IC) or Interexchange Common Carrier

Any individual, partnership, association, joint-stock company, trust, governmental entity or corporation engaged for hire in interstate, intrastate or foreign communication by wire or radio between two or more exchanges.

Intermodulation Distortion

A measure of the nonlinearity of a channel. It is measured using four tones, and evaluating the ratios (in dBs) of the transmitted composite four-tone signal power to the second-order products of the tones (R2), and the third-order products of the tones (R3).

Intrastate Communications

Any communications within a state subject to oversight by a state regulatory commission as provided by the laws of the state involved.

IntraMTA

The term "IntraMTA" refers to traffic that originates and terminates within a Major Trading Area (MTA) and only applies to wireless providers. MTAs are centered on a major city and generally cover an area the size of a state.

(N)
—
(N)

Kilosegment

One thousand segments.

Letter of Authorization (LOA)

The signed authorization form from a customer or agent of Public or Semipublic Pay Telephones designating the primary IC (PIC) for interLATA access.

Lineside Connection

A connection of a transmission path to the lineside of a local exchange switching system.

Local Access and Transport Area (LATA)

A geographic area established for the provision and administration of communications service. It encompasses one or more designated exchanges, which are grouped to serve common social, economic and other purposes.



NOTICE

2. GENERAL REGULATIONS

2.6 DEFINITIONS (Cont'd)

Local Calling Area

A geographical area, as defined in the Company's Local and/or General Exchange Service Catalog, in which an end user (telephone exchange service subscriber) may complete a call without incurring MTS charges. It includes EAS points.

Local Tandem Switch

A local Company switching unit by which local or access telephonic communications are switched to and from an End Office Switch.

Location Provider

The individual, corporation, municipality or other entity who controls the location at which Pay Telephones are placed. For the purposes of Pay Telephones, it is the location provider who designates the primary IC for Pay Telephones located on its premises.

Logical Channel

A communications channel through the network that allows simultaneous transmission of sequenced data packets through the network. No circuit capacity is preassigned to a logical channel; capacity is made available as data is transmitted.

Loop Around Test Line

An arrangement utilizing a telephone company central office to provide a means to make certain two-way transmission tests on a manual basis. This arrangement has two central office terminations, each reached by means of separate telephone numbers and does not require any specific customer premises equipment. Equipment subject to this test arrangement is at the discretion of the customer.

Loss Deviation

The variation of the actual loss from the designed value.

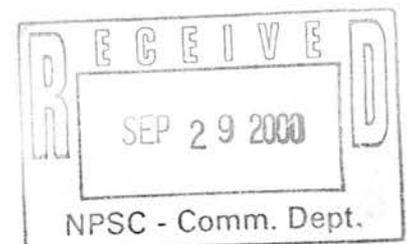

2. GENERAL REGULATIONS

2.6 DEFINITIONS (Cont'd)

Major Fraction Thereof

Any period of time in excess of 1/2 of the stated amount of time. As an example, in considering a Switched Access Service period of four (4) hours, a major fraction thereof would be any period of time in excess of 2 hours exactly. Therefore, if a given service is interrupted for a period of six hours and one minute, the customer would be given a credit allowance for two four-hour periods.

Message

A "call" as defined preceding.

Milliwatt (102 Type) Test Line

An arrangement in an end office which provides a 1004 Hz tone at 0 dBm0 for one-way transmission measurements towards the customer's premises from the Company end office.

Mobile Telephone Switching Office (MTSO)

The switching facility used by a Commercial Mobile Radio Service in performing originating and terminating switching functions for calls exchanged between their customers, the Company customers, Interexchange Carriers and Independent Telephone Company customers.

Modification of Final Judgement (MFJ)

The consent decree approved by the U.S. District Court in United States versus Western Electric 552 F. Supp. 171 (To D.C. 1982).

MTS/WATS - Type

Execunet/Sprint-type services which MCI Telecommunications Corporation presently markets as Execunet and Network Service and which GTE Sprint (formerly Southern Pacific Communications Company) markets as Sprint IV or V or any other like service which may be offered by those two carriers or any other Other Common Carrier.

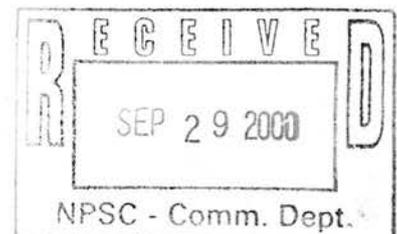

2. GENERAL REGULATIONS

2.6 DEFINITIONS (Cont'd)

Multifrequency (MF) Address Signaling

A signaling method in which a combination of two out of six Voiceband frequencies are used to represent a digit or a control signal.

Multiplexing

A method of concentrating information via signal processing techniques (i.e., frequency division, multiplexing, time division multiplexing, etc.)

Network Address

A numeric character string used to identify the customer network location of the DTE and the destination of each virtual call made within the network to that location.

Network Control Signaling

The transmission of signals used in the telecommunications system which perform functions such as supervision (control, status, and charge signals), address signaling (e.g., dialing), calling and called number identifications, rate of flow, service selection error control and audible tone signals (call progress signals indicating re-order or busy conditions, alerting, coin denominations, coin collect and coin return tones) to control the operation of the telecommunications system.

Non-8YY

All calls that are not toll free (8YY) as established by the FCC's 8YY Access Charge Reform Order (FCC 20-143) released on October 9, 2020.

(N)

(N)

Non-Inverting Digital Loopback (108 Type) Test Line

Termination in a digital Company switch location to conduct digital testing of digital services (i.e., 56 kbps, 64 kbps and 64 kbps clear channel).

Nonsynchronous Test Line

An arrangement in step-by-step end offices which provides operational tests which are not as complete as those provided by the synchronous test lines, but can be made more rapidly.

North American Numbering Plan (NANP)

A three-digit area (Numbering Plan Area) code and a seven-digit telephone number made up of a three-digit central office code plus a four-digit station number.

2. GENERAL REGULATIONS

2.6 DEFINITIONS (Cont'd)

Octet

A continuous sequence of eight binary bits of information.

Off-Hook

The active condition of Switched Access or a Telephone Exchange Service line.

Office Replacement

A situation where the hardware and software in a Company switching office is replaced with different hardware and software for the establishment and maintenance of a given switching office.

On-Hook

The idle condition of Switched Access or a Telephone Exchange Service line.

Open Circuit Test Line

An arrangement in an end office which provides an ac open circuit termination of a trunk or line by means of an inductor of several Henries.

Originating Direction

The use of Access Service for the origination of calls from an end user's premises to a customer's premises.

Packet

A continuous sequence of binary bits of information which is switched through the network as an integral unit. Consists of up to 2048 bits (256 octets) of customer data plus additional transmission and error control information.

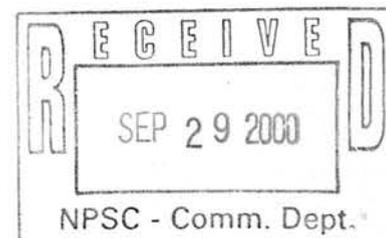

2. GENERAL REGULATIONS

2.6 DEFINITIONS (Cont'd)

Packet Switch Node (PSN)

The hardware/software components of the Public Packet Switching Network which performs switching functions and is the single X.75 gateway within each LATA. The Packet Switch Node is located on Company premises.

Packet Switch Service Point (PSSP)

The hardware/software components of the Public Packet Switch Network which performs switching functions. The Packet Switch Service Point is located on company premises.

Pay Telephone

Denotes an instrument provided by a Payphone Service Provider that is available to the general public for public convenience and necessity. Pay telephones utilize Basic and Smart Public Access Line Service provided under the Exchange and Network Services Catalog.

Payphone Service Provider (PSP)

Denotes an entity that controls and incurs the costs of placement and maintenance of pay telephones.

Percent Interstate Use (PIU)

The term "Percent Interstate Use" (PIU) refers to traffic that originates in one state and terminates in a different state.

(N)
|
(N)

Permanent Virtual Circuit (PVC)

A logical channel between two points on the network that is established by service order and available on a permanent basis. No call establishment, call termination, or network address is associated with a permanent virtual circuit.

Phase Jitter

The unwanted phase variations of a signal.

Point of Termination (POT)

A point at or near a customer-designated premises at which the Company's responsibility for the provision of Access Service ends.



2. GENERAL REGULATIONS

2.6 DEFINITIONS (Cont'd)

Primary IC (PIC)

The Interexchange Carrier (IC) of choice as designated by an end user for business or residential service or a location provider for Pay Telephone service.

Premises

A building, portion of a building in a multitenant building or buildings on continuous property (except Railroad Right-of-Way, etc.) not separated by a public highway. It may also denote a customer-owned enclosure or utility vault located above ground or underground on private property or on customer-acquired right-of-way. Except for an end user that offers Telecommunications Services exclusively as a reseller, this term is not to be limited to one building, but applies as well to a complex, or campus-type configuration of, buildings.

Public Access Line (PAL) Service

Basic and Smart Public Access Line Service available under the Exchange and Network Services Catalog of the Company for use with pay telephones.

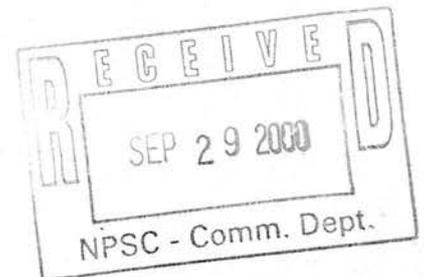

NOTICE

THE INFORMATION CONTAINED IN THIS DOCUMENT IS SUBJECT TO CHANGE.
NE2000-054

2. GENERAL REGULATIONS

2.6 DEFINITIONS (Cont'd)

Query

The inquiry to a Company data base to obtain information, processing instructions or service data.

Registered Equipment

The customer's premises equipment which complies with and has been approved within the Registration Provisions of Part 68 of the F.C.C.'s Rules and Regulations.

Release Message

A SS7 message sent in either direction to indicate the release of a specific circuit.

Remote Switching Modules and/or Remote Switching Systems

Small, remotely controlled electronic end office switches which obtain their call processing capability from an ESS-type Host Office. The RSM/RSS cannot accommodate direct trunks to a customer.

Responsible Organization (RESP ORG)

The entity that is responsible for the management and administration of 800 Data Base Access Service records in the Service Management System according to Guidelines for 800 Data Base.

Return Loss

A measure of the similarity between the two impedances at the junction of two transmission paths. The higher the return loss, the higher the similarity.

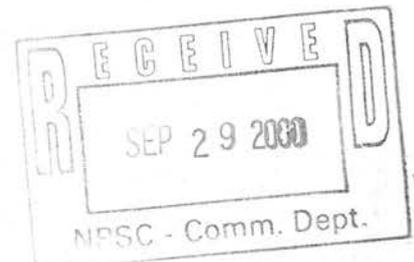

2. GENERAL REGULATIONS

2.6 DEFINITIONS (Cont'd)

Segment

A continuous sequence of binary bits of information within a packet. A segment has a billable length of up to 64 octets of customer data transmitted to or from a port.

Service Control Point (SCP)

The node in the network where several independent data base applications receive and respond to SS7 queries.

Service Management System/800 (SMS/800)

The main operations support system of 800 Data Base Access Service. It is used to create and update subscriber 8XX records that are then downloaded to SCPs for handling subscribers' 8XX calls (see "Service Control Points"). The system is also used by 8XX responsible organizations to reserve and assign 8XX numbers.

Service Switching Point (SSP)

A signal point equipped with the ability to halt call process, formulate and send a SS7 query to a remote location and route the call based on information contained in the response.

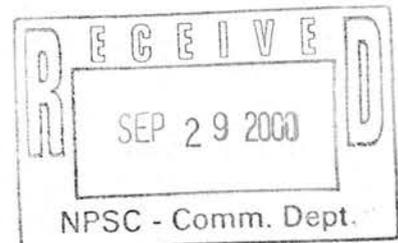

2. GENERAL REGULATIONS

2.6 DEFINITIONS (Cont'd)

Serving Wire Center

The local Company office from which dial tone for local exchange service would normally be provided to the customer premises.

Seven Digit Manual Test Line

An arrangement which allows the customer to select balance, milliwatt and synchronous test lines by manually dialing a seven digit number over the associated access connection.

Short Circuit Test Line

An arrangement in an end office which provides for an ac short circuit termination of a trunk or line by means of a capacitor of at least four microfarads.

Signal Point (SP)

An end node in a CCSN Signal Points can be switches (i.e., end offices and access tandems), data bases or operator service systems that are equipped with CCS.

Signal-to-C-Notched Noise Ratio

The ratio in dB of a test signal to the corresponding C-Notched Noise.

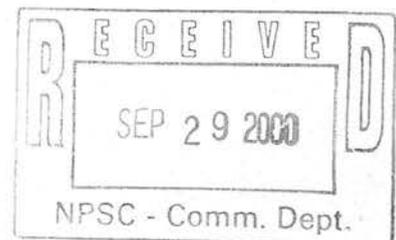

2. GENERAL REGULATIONS

2.6 DEFINITIONS (Cont'd)

Signal Transfer Point (STP)

A switch which provides CCSN access and performs CCSN message routing and screening.

Signal Transfer Point Port (STP PORT)

The POT on the STP which provides CCSN access.

Signaling System 7 (SS7)

The signaling protocol in the CCSN.

Singing Return Loss

The frequency weighted measure of return loss at the edges of the voiceband (200 to 500 Hz and 2500 to 3200 Hz), where singing (instability) problems are most likely to occur.

Special Order

An order for a Voice DA Service.

(C)

Subtending End Office of an Access Tandem

An end office that has final trunk group routing through that tandem.

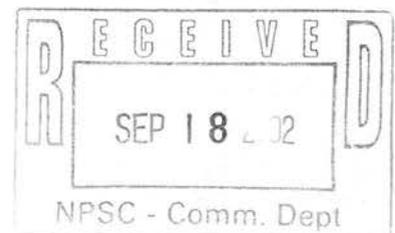

2. GENERAL REGULATIONS

2.6 DEFINITIONS (Cont'd)

Switching System

The hardware and/or software utilized by the Company for the establishment and maintenance of a given central office.

Synchronous Test Line

An arrangement in an end office which performs marginal operational tests of supervisory and ring-tripping functions.

Tandem-Switched Transport (TST)

The transport between an access tandem and end offices that subtend the access tandem that utilizes tandem switching functions. Tandem-Switched Transport consists of circuits used in common by multiple customers from the tandem to an end office.

Terminating Direction

The use of Access Service for the completion of calls from a customer's premises to an end user's premises.

Toll VoIP-PSTN Traffic

The term Toll VoIP-PSTN Traffic denotes a customer's interexchange voice traffic exchanged with the Telephone Company in Time Division Multiplexing format over PSTN facilities, which originates and/or terminates in Internet Protocol (IP) format. Toll VoIP-PSTN Traffic originates and /or terminates in IP format when it originates from and/or terminates to an end user customer of a service that requires IP-compatible customer premises equipment.

(N)
—
(N)

Traffic Types

One of six Switched Access capacity types. They are Originating, Terminating, SWITCHNET 56 Service, CCC Originating, CCC Terminating and Voice DA. See 6.1.1, following, for application.

Transaction Capabilities Application Part (TCAP)

The design of non-circuit related messages. TCAP protocol provides a means for reliable transfer of information from one application at a switch location to another application within another network entity.

(M)

(M) Material moved to Page 78.



2. GENERAL REGULATIONS

2.6 DEFINITIONS (Cont'd)

Transmission Measuring (105 Type) Test Line/Responder

An arrangement in an end office which provides far-end access to a responder and permits two-way loss and noise measurements to be made on trunks from a near end office.

(M)
—
(M)

Transmission Path

An electrical path capable of transmitting signals within the range of the service offering; e.g., a voice grade transmission path is capable of transmitting voice frequencies within the approximate range of 300 to 3000 Hz. A transmission path comprises physical or derived channels consisting of any form or configuration of facilities typically used in the telecommunications industry.

Trunk

A communications path connecting two switching systems in a network, used in the establishment of an end-to-end connection.

Trunk Group

A set of trunks which are traffic engineered as a unit for the establishment of connections between switching systems in which all of the communications paths are interchangeable.

Trunkside Connection

The connection of a transmission path to the trunkside of a local exchange switching system.

Two-Wire to Four-Wire Conversion

An arrangement which converts a four-wire transmission path to a two-wire transmission path to allow a four-wire facility to terminate in a two-wire entity (e.g., a central office switch).

Underground Utility Vault

An underground enclosure where conduits are terminated and which provides ready access to conduit systems.

(M) Material moved from Page 77.

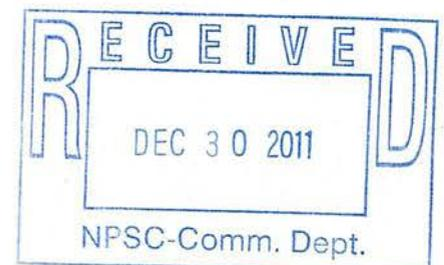

NOTICE

THE INFORMATION CONTAINED IN THIS DOCUMENT IS SUBJECT TO CHANGE.
NE2011-024

Qwest Corporation d/b/a CenturyLink QC
Access Service
Catalog

SECTION 2
Page 79
Release 2
Effective: 03-31-2017

(C)

State of Nebraska
Notified: 03-20-2017

2. GENERAL REGULATIONS

2.6 DEFINITIONS (Cont'd)

(D)
—
(D)

V and H Coordinates Method

A method of computing airline miles between two points by utilizing an established formula which is based on the vertical (V) and horizontal (H) coordinates of the two points.

Virtual Circuit

A logical channel established as a result of the call establishment procedure to a network address that exists for a period of time until either end of the channel initiates the call termination.

Voice Directory Assistance (Voice DA)

The provision of telephone numbers by a Company operator when the operator location is accessed by a customer by sending the appropriate signals, i.e., off-hook, 555-1212, (NPA)+555-1212 or 411, where available.

Voice Directory Assistance (Voice DA Location)

A Company end office where Company equipment first receives the Voice DA call from a customer and selects the first operator position to respond to the Voice DA call.

WATS Serving Office

A Company-designated end office switch which is capable of performing routing, screening and recording functions in connection with the closed-end of 800/800-type call, Outward WATS and similar services. Designation of an end office switch as a WSO is based upon the capability and capacity of the end office switch to provide WATS Access Service. WATS Serving Offices are identified in the National Exchange Carrier Association Tariff F.C.C. No. 4.

Wire Center

A building in which one or more central offices, used for the provision of exchange services, are located.

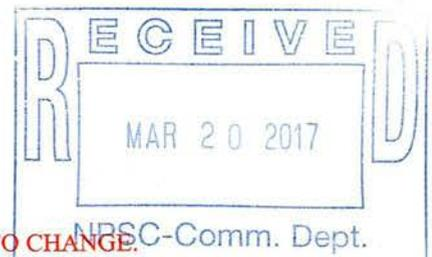

2. GENERAL REGULATIONS

2.7 SHARED USE REGULATIONS

Shared Use occurs when the Company allows a customer to utilize the same transport facility for different services. When the same transport facility and the associated options are utilized to provide more than one service, the Company shall apportion the monthly billing of the appropriate transport elements between the shared services.

The rate elements subject to the Shared Use allocation process are the recurring elements assessed for transport facilities only between a customer's premises and the serving wire center (SWC) of that premises and the interoffice facilities from the customer's SWC to other wire centers which may include access tandems, end offices, and hubbing locations. Rate elements not associated with transport facilities are not allocated. The nonrecurring installation charges for each service are not apportioned and are assessed except as set forth in this section.

The Shared Use transport facility is ordered and provided as Private Line Transport Service (PLTS) unless otherwise described in this section. The specific Shared Use regulations and/or exceptions are described following:

- DS1 and DS3 PLTS with Switched Access Service is described in 2.7.1,
- Expanded Interconnection Channel Termination with PLTS and Switched Access is described in 2.7.2, and
- Switched Access Service with Common Channel Signaling Access Capability Service (CCSAC) is described in 2.7.3, following

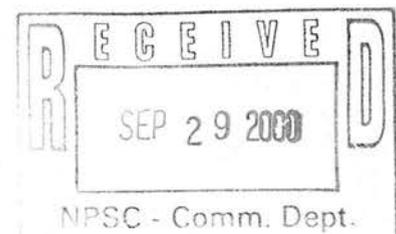

NOTICE

THE INFORMATION CONTAINED IN THIS DOCUMENT IS SUBJECT TO CHANGE.
NE2000-054

2. GENERAL REGULATIONS

2.7 SHARED USE REGULATIONS (Cont'd)

2.7.1 DS1 AND DS3 PLTS WITH SWITCHED ACCESS SERVICE

When DS1 and DS3 PLTS (including a facility to a Hub) is shared between PLTS and Switched Access Service (including CCSAC), the service is ordered, provided and rated as PLTS until the customer chooses to place an order for Switched Access Service. When the customer chooses to use a portion of the available capacity on existing PLTS for providing Switched Access Service, the customer shall place an order for each individual Switched Access Service and specify the channel assignment for the Shared Use facility.

When the PLTS transport facilities are shared with Switched Access Service, the transport recurring PLTS rate elements (e.g., Channel Termination, Transport Channel and multiplexing) as well as the Switched Access Service transport recurring rate elements (e.g., Entrance Facility, Direct-Trunked Transport Facility and/or Direct Link Transport and associated multiplexing), are apportioned based on the total number of channels utilized for each service. The Switched Access rate for DS3 EF Electrical capacity of two or greater or any Optical Interface rate as set forth in Section 6, following, is for the billing of Shared Use only.

The recurring rate elements associated with multiplexing equipment are apportioned based on the number of channels utilized for each service when both Switched and PLTS multiplexing rate elements are chargeable.

When CCSAC Service is ordered on a Shared Use facility, the customer must dedicate, at a minimum, one DS1 facility for that service.

When PLTS facilities are provided from the SWC of the customer's premises to a Company hub and those facilities are shared with Switched Access Service, the appropriate PLTS transport channel mileage rates and the Switched DTT or DLT rates are apportioned. Switched DTT facilities must be provisioned from the Company hub to an access tandem or end office based on whether the customer requests tandem routing or direct routing.

PLTS and Switched Access Service rates elements not associated with transport facilities are not allocated. Following on the next page, is an example of Shared Use allocation.

Appropriate nonrecurring installation charges are assessed on a per-line, per-trunk or per-link basis for Switched Access Service.

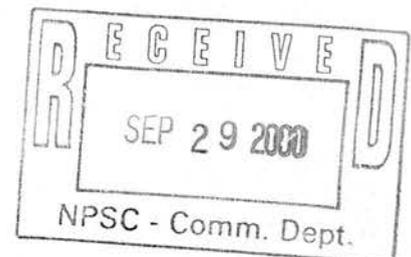

NOTICE

THE INFORMATION CONTAINED IN THIS DOCUMENT IS SUBJECT TO CHANGE.
NE2000-054

2. GENERAL REGULATIONS

2.7 SHARED USE REGULATIONS

2.7.1 DS1 AND DS3 PLTS WITH SWITCHED ACCESS SERVICE (Cont'd)

Example of Shared Use

- Customer has DS3 PLTS comprised of a DS3 Channel Termination and a DS3/DS1 Multiplexer in the SWC of the customer's premises.
- Customer orders 24 Feature Group D trunks to ride a DS1 DTT facility to an end office (Section 6) and specifies that the DS1 DTT facility be assigned to the DS3 PLTS facility for the associated Switched Access Entrance Facility.
- Switched Access Service Rates and Charges

24/672 of the Switched DS3 Entrance Facility rate
100% Switched DS1 DTT facility rate
24/672 of the Switched DS3/DS1 Multiplexer rate

- PLTS Rates and Charges

648/672 of the PLTS DS3 Channel Termination
648/672 of the PLTS DS3/DS1 Multiplexer

In the above example, if the PLTS DS3 Service has Transport Channel mileage in addition to the Channel Termination, the Switched DS1 DTT facility rate and the PLTS Transport Channel rate are also apportioned.

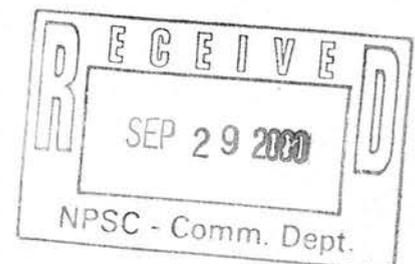

2. GENERAL REGULATIONS

2.7 SHARED USE REGULATIONS (Cont'd)

2.7.2 EXPANDED INTERCONNECTION CHANNEL TERMINATION

When a customer with a Private Line Expanded Interconnection Channel Termination (EICT) provides Shared Use, the apportioned factor (between Switched Access Service and PLTS) applied to the EICT rate element will be the same apportioned factor as determined for the PLTS facility as described in 2.7.1, preceding.

2.7.3 SWITCHED DS3 FACILITY WITH CCSAC SERVICE

Shared Use may occur when Switched Access Service, as set forth in Section 6, following, and CCSAC Service, as set forth in Section 15, following, are provided over the same DS3 facility. The DS3 facility must be ordered, provided and rated from Section 6 until the customer chooses to use a portion of the facility for CCSAC Service.

When the customer chooses to use a portion of the available capacity (i.e., DS1) of a DS3 facility for providing CCSAC, the customer shall place an order for each individual CCSAC Service from Section 15, following, and specify the channel assignment for the Shared Use facility. The customer must dedicate, at a minimum, one DS1 facility for the CCS Links. Since a minimum of one DS1 is utilized for CCS Links, the number of channels apportioned for CCSAC will be in multiples of 24 channels. All rates and charges will be apportioned as set forth in 2.7.1, preceding.

Where PLTS or Switched Access Service (Section 6) is provided and a portion of the facility is utilized for Shared Use to a Hub, rates and charges are apportioned for the facility to the Hub as set forth in 2.7.1, preceding, and individual service rates and charges for CCSAC apply from the Hub to the Company STP as set forth in Section 15, following.

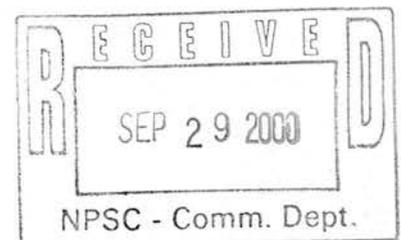

State of Nebraska
Notified: 5-9-2013

3. CARRIER COMMON LINE ACCESS SERVICE

SUBJECT	PAGE	
Access Groups	1	
Billing of Charges	10	
Common Channel Signaling Access Capability Exemption	3	
Customer Obligations Concerning the Resale of MTS and MTS-Type Services	5	
Density Zone Pricing Plan	10	(C-M)
Determination of Jurisdiction	2	
Determination of Rates	11	
Determination of Usage Subject to Carrier Common Line Access Charges	2	
Exclusions	1	
General Description	1	
Interstate and Intrastate Use	2	
Limitations	1	
Local Exchange Access and Enhanced Services Exemption	3	
Obligations of the Customer	2	
Payment Options	10	
Percent Interstate Use (PIU)	11	
Provision of Service	2	

(M) Material moved from Index Page 2.

State of Nebraska
Notified: 5-9-2013

3. CARRIER COMMON LINE ACCESS SERVICE

SUBJECT	PAGE
Rate Terms and Conditions	10
Rate Terms and Conditions Concerning the Resale of MTS and MTS-Type Services	6
Rates	12
Resale Documentation Provided by the Customer	5
Resold Services	4
Scope	4
Supervision	2
Switched Access Service Provided in Conjunction With a Commercial Mobile Radio Service Provider.....	3
Switched Access Service Requirement	2
Undertaking of the Company	2
Unmeasured Feature Group A and B Usage	11
WATS Access Lines	1

(M)

(M) Material moved to Index Page 1.

Qwest Corporation
Access Service
Catalog

SECTION 3

Page 1

Release 1

Effective: 9-29-2000

State of Nebraska
Notified: 9-29-2000

3. CARRIER COMMON LINE ACCESS SERVICE

3.1 GENERAL DESCRIPTION

Carrier Common Line Access Service provides for the use of Company common lines by customers for access to end users to furnish intrastate telecommunications service. WATS Access Service as described in 6.3.1.P., following, is not subject to Carrier Common Line Access Service provisions.

The Company will provide Carrier Common Line Access Service (Carrier Common Line Access) to customers in conjunction with Switched Access Service provided in Section 6 of this Catalog.

3.2 LIMITATIONS

3.2.1 EXCLUSIONS

Neither a telephone number nor detail billing are provided with Carrier Common Line Access. Additionally, directory listings and intercept arrangements are not included in the rates and charges for Carrier Common Line Access.

3.2.2 ACCESS GROUPS

All line side connections provided in the same access group will be limited to the same features and operating characteristics.

All trunk side connections provided in the same access group will be limited to the same features and operating characteristics.

3.2.3 WATS ACCESS LINES

Switched Access Service minutes which originate from or terminate to a WATS or WATS-like access line, (i.e., originating minutes for outward WATS and WATS-type services and terminating minutes for inward WATS and WATS-type services) shall not be assessed Carrier Common Line Access per minute charges.

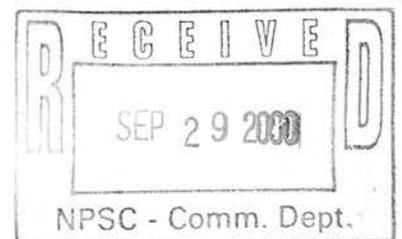

3. CARRIER COMMON LINE ACCESS SERVICE

3.3 UNDERTAKING OF THE COMPANY

3.3.1 PROVISION OF SERVICE

Where the customer is provided Switched Access Service under other sections of this Catalog, the Company will provide the use of Company common lines by a customer for access to end users at rates and charges as set forth in 3.8, following.

3.3.2 INTERSTATE AND INTRASTATE USE

The Switched Access Service provided by the Company includes the Switched Access Service provided for both interstate and intrastate communications. The Carrier Common Line Access rates and charges as set forth in 3.8, following, apply to Switched Access Service access minutes in accordance with the rate terms and conditions, as set forth in 3.7.6, following.

3.4 OBLIGATIONS OF THE CUSTOMER

3.4.1 SWITCHED ACCESS SERVICE REQUIREMENT

The Switched Access Service associated with Carrier Common Line Access shall be ordered by the customer under other sections of this Catalog.

3.4.2 SUPERVISION

The customer facilities at the premises of the ordering customer shall provide the necessary on-hook and off-hook supervision.

3.5 DETERMINATION OF USAGE SUBJECT TO CARRIER COMMON LINE ACCESS CHARGES

Except as set forth herein, all Switched Access Service provided to the customer will be subject to Carrier Common Line Access charges.

3.5.1 DETERMINATION OF JURISDICTION

When the customer reports interstate and intrastate use of Switched Access Service, the associated Carrier Common Line Access used by the customer for interstate will be determined as set forth in 3.7.6, following (Percent Interstate Use-PIU).

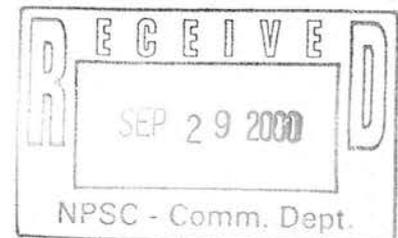

NOTICE

THE INFORMATION CONTAINED IN THIS DOCUMENT IS SUBJECT TO CHANGE.
NE2000-054

Qwest Corporation
Access Service
Catalog

SECTION 3

Page 3

Release 1

Effective: 9-29-2000

State of Nebraska
Notified: 9-29-2000

3. CARRIER COMMON LINE ACCESS SERVICE

3.5 DETERMINATION OF USAGE SUBJECT TO CARRIER COMMON LINE ACCESS CHARGES (Cont'd)

3.5.3 LOCAL EXCHANGE ACCESS AND ENHANCED SERVICES EXEMPTION

When access to the local exchange is required to provide a customer service (e.g., MTS/WATS-type, telex, Data, etc.) that uses a resold private line service, Switched Access Service Rates and Regulations, as set forth in Section 6, following will apply, except when such access to the local exchange is required for the provision of an enhanced service. Carrier Common Line Access rates and charges as set forth in 3.8, following, apply in accordance with the rate terms and conditions as set forth in 3.7, following:

3.5.4 SWITCHED ACCESS SERVICE PROVIDED IN CONJUNCTION WITH A COMMERCIAL MOBILE RADIO SERVICE PROVIDER

For Switched Access Service provided in conjunction with a Commercial Mobile Radio Service provider, Carrier Common Line Access rates do not apply.

3.5.5 COMMON CHANNEL SIGNALING ACCESS CAPABILITY EXEMPTION

Common Channel Signaling Access Service as set forth in Section 15, following, are not subject to a Carrier Common Line rate.

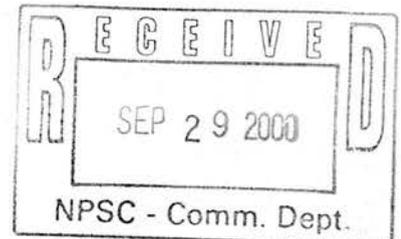

NOTICE

THE INFORMATION CONTAINED IN THIS DOCUMENT IS SUBJECT TO CHANGE.
NE2000-054

3. CARRIER COMMON LINE ACCESS SERVICE

3.6 RESOLD SERVICES

3.6.1 SCOPE

Where the customer is reselling MTS and/or MTS-type service(s) on which the Carrier Common Line and Switched Access charges have been assessed, the customer may, at the option of the customer, obtain Feature Group A, Feature Group B or Feature Group D Switched Access Service under this Catalog as set forth in Section 6, following, for originating and/or terminating access in the local exchange. Such access group arrangements whether single line or trunks or multiline hunt groups or trunk groups will have Carrier Common Line Access charges applied as set forth in 3.8, following, in accordance with the resale rate terms and conditions set forth in 3.6.4, following. For purposes of administering this provision:

- Resold intrastate terminating MTS and MTS-type service(s) shall include collect calls, third number calls and credit card calls where the reseller pays the underlying carrier's service charges; and shall not include interstate minutes of use.
- Resold intrastate originating MTS and MTS-type service(s) shall not include collect, third number, credit card or interstate minutes of use.

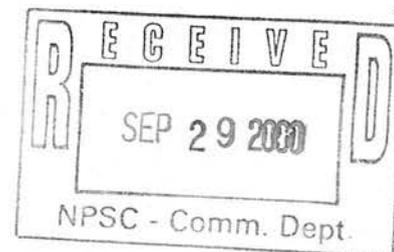

NOTICE

THE INFORMATION CONTAINED IN THIS DOCUMENT IS SUBJECT TO CHANGE.
NE2000-054

3. CARRIER COMMON LINE ACCESS SERVICE

3.6 RESOLD SERVICES (Cont'd)

3.6.2 CUSTOMER OBLIGATIONS CONCERNING THE RESALE OF MTS AND MTS-TYPE SERVICES

When the customer is reselling MTS and/or MTS-type service as set forth in 3.6.1, preceding, the customer will be charged Carrier Common Line Access charges in accordance with the resale rate terms and conditions as set forth in 3.6.4, following, if the customer or the provider of the MTS service furnishes documentation of the MTS usage and/or the customer furnishes documentation of the MTS-type usage. Such documentation supplied by the customer shall be supplied each month and shall identify the involved resold MTS and/or MTS-type services.

The monthly period used to determine the minutes of use for resold MTS and/or MTS-type service(s) shall be the most recent monthly period for which the customer has received a bill for such resold service(s). This information shall be delivered to the Company, at a location specified by the Company, no later than 15 days after the bill date shown on the resold MTS and/or MTS-type service bill. If the required information is not received by the Company, the previously reported information, as described preceding will be used for the next two months. For any subsequent month, no allocation or credit will be made until the required documentation is delivered to the Company by the customer.

3.6.3 RESALE DOCUMENTATION PROVIDED BY THE CUSTOMER

When the customer utilizes Switched Access Service as set forth in 3.6.2, preceding, the Company may request a certified copy of the customer's resold MTS or MTS-type Service. Requests for billing will relate back no more than 12 months prior to the current billing period.

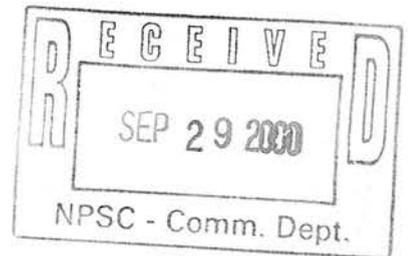

Qwest Corporation
Access Service
Catalog

SECTION 3
Page 6
Release 2
Effective: 7-1-2016

State of Nebraska
Notified: 6-1-2016

3. CARRIER COMMON LINE ACCESS SERVICE

3.6 RESOLD SERVICES (Cont'd)

3.6.4 RATE TERMS AND CONDITIONS CONCERNING THE RESALE OF MTS AND MTS-TYPE SERVICES

When the customer is provided an access group to be used in conjunction with the resale of MTS and/or MTS-type services as set forth in 3.6.1, preceding, and the Company receives the usage information required as set forth in 3.6.2, preceding, to calculate the adjustment of Carrier Common Line Access charges, the customer will be billed as set forth in D., following, depending upon, respectively, whether the usage is from non equal access offices, equal access offices or a combination of the two.

A. Apportionment and Adjustment of Resold Minutes of Use

When the customer is provided with more than one access group in a State in association with the resale of MTS and/or MTS-type services, the resold minutes of use will be apportioned as follows: (C)

1. Originating Services

The Company will apportion the resold originating MTS and/or MTS-type services and originating minutes of use for which the resale credit adjustment applies, among the access groups. Such apportionment will be based on the relationship of the originating usage for each access group to the total originating usage for all access groups in the State. For purposes of administering this provision: (C)

Resold originating MTS and/or MTS-type services minutes shall be only those attributable to intrastate originating MTS and/or MTS-type minutes and shall not include collect, third number, credit card or interstate minutes of use.

The resale credit adjustment shall apply for resold originating MTS and MTS-type services and minutes of use, provided Carrier Common Line and Switched Access Charges have been assessed on such services.

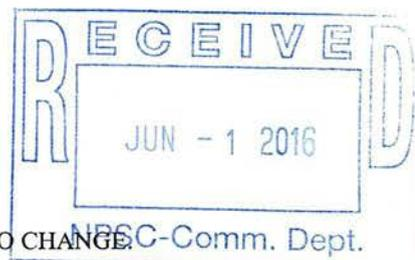

Qwest Corporation
Access Service
Catalog

SECTION 3
Page 7
Release 2
Effective: 7-1-2016

State of Nebraska
Notified: 6-1-2016

3. CARRIER COMMON LINE ACCESS SERVICE

3.6 RESOLD SERVICES

3.6.4 RATE TERMS AND CONDITIONS CONCERNING THE RESALE OF MTS AND MTS-TYPE SERVICES

A. Apportionment and Adjustment of Resold Minutes of Use (Cont'd)

2. Terminating Services

The Company will apportion the resold terminating MTS and/or MTS-type services and terminating minutes of use for which the resale credit adjustment applies, among the access groups. Such apportionment will be based on the relationship of the terminating usage for each access group to the total terminating usage for all access groups in the State. For purposes of administering this provision:

(C)

Resold and terminating MTS and/or MTS-type services minutes shall be only those attributable to intrastate terminating MTS/MTS-type (i.e., collect calls, third number calls, and credit card calls) and shall not include interstate minutes of use or MTS/MTS-type minutes of usage paid for by another party.

The resale credit adjustment shall apply for resold terminating MTS and MTS-type services and minutes of use, provided Carrier Common Line and Switched Access Charges have been assessed on such services.

B. Same State/Telephone Company/Exchange Limitation

In order for the rate regulations to apply as set forth in D., following, the access groups and the resold MTS and/or MTS-type services must be provided in the same state (except when the same extended area service arrangement is provided in two different states by the same telephone company) in the same exchange, provided by the same Company and connected directly or indirectly. For those exchanges that encompass more than one state, the customer shall report the information by state within the exchange.



3. CARRIER COMMON LINE ACCESS SERVICE

3.6 RESOLD SERVICES

3.6.4 RATE TERMS AND CONDITIONS CONCERNING THE RESALE OF MTS AND MTS-TYPE SERVICES (Cont'd)

C. Direct and Indirect Connections

Each of the access group arrangements used by the customer in association with the resold MTS and/or MTS-type services must be connected either directly or indirectly to the customer designated premises at which the resold MTS and/or MTS-type services are terminated. Direct connections are those arrangements where the access groups and resold MTS and/or MTS-type services are terminated at the same customer designated premises.

Indirect originating connections are those arrangements where the access groups and the resold originating MTS and/or MTS-type services are physically located at different customer designated premises in the same exchange. Such different customer designated premises are connected by facilities that permit a call to flow from access groups to resold MTS and/or MTS-type services.

Indirect terminating connections are those arrangements where the access groups and resold terminating MTS and/or MTS-type services are physically located at different customer designated premises in the same exchange. Such different customer designated premises are connected by facilities that permit a call to flow from resold terminating MTS and/or MTS-type services to access groups.

D. Access Groups

The adjustments as set forth here will be computed separately for each access group.

The Access Minutes which will be subject to Carrier Common Line Access charges will be the adjusted originating intrastate access minutes plus the adjusted terminating intrastate access minutes for such access groups.

The adjusted originating access minutes will be the originating intrastate access minutes less the reported resold originating MTS and/or MTS-type service minutes of use as set forth in A.1., preceding; but not less than zero. The adjusted terminating access minutes will be the terminating intrastate access minutes less the reported resold terminating MTS and/or MTS-type service minutes of use as set forth in A.2., preceding; but not less than zero.

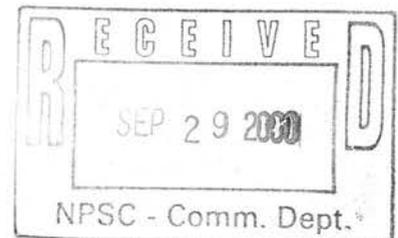

NOTICE

THE INFORMATION CONTAINED IN THIS DOCUMENT IS SUBJECT TO CHANGE.
NE2000-054

Qwest Corporation
Access Service
Catalog

SECTION 3

Page 9

Release 1

Effective: 9-29-2000

State of Nebraska
Notified: 9-29-2000

3. CARRIER COMMON LINE ACCESS SERVICE

3.6 RESOLD SERVICES

3.6.4 RATE TERMS AND CONDITIONS CONCERNING THE RESALE OF MTS AND MTS-TYPE SERVICES (Cont'd)

E. When the Adjustment Will Be Applied to Customer Bills

The adjustment as set forth in D., preceding will be made to the involved customer account no later than either the next bill date, or the one subsequent to that, depending on when the usage report is obtained.

F. Conversion of Billed Usage to Minutes

When the MTS and/or MTS-type usage is shown in hours, the number of hours shall be multiplied by 60 to develop the associated MTS and/or MTS-type minutes of use. If the MTS and/or MTS-type usage is shown in a unit that does not show hours or minutes, the customer shall provide a factor to convert the shown units to minutes.

G. Percent Interstate Use (PIU)

The adjustment as set forth in D., preceding, will be made to the involved customer account after making the adjustments to the customer account as set forth in 3.7.6, following (PIU).

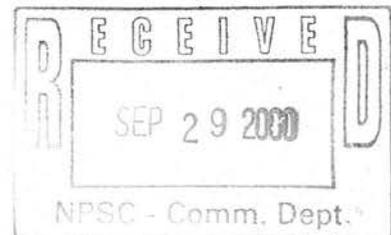

NOTICE

THE INFORMATION CONTAINED IN THIS DOCUMENT IS SUBJECT TO CHANGE.
NE2000-054

(C)

3. CARRIER COMMON LINE ACCESS SERVICE

3.7 RATE TERMS AND CONDITIONS

3.7.1 BILLING OF CHARGES

Carrier Common Line charges will be billed to each Switched Access Service provided under this Catalog in accordance with the terms and conditions as set forth in 3.7.7, following (Determination of Rates), except as set forth in 3.6.4, preceding (Resale), 3.2.3, preceding (WATS Access Lines) and 3.7.6, following (PIU).

3.7.2 DENSITY ZONE PRICING PLAN

A. General

The Density Zone Pricing Plan consists of Zones 1, 2 and 3. The Density Zone Pricing Plan applies to EF DS1 and DS3, DTT DS1 and DS3, EF DS1 to VG multiplexing, EF DS3 to DS1 multiplexing, DTT DS1 to VG multiplexing, DTT DS3 to DS1 multiplexing and DS1 to DS3 rollover rates and charges.

For DTT DS1 and DTT DS3 and associated multiplexing equipment provisioned between a Company serving wire center in one zone and a Company Hub, tandem or end office wire center located in a different zone, the zone with the highest mileage rate is the applicable zone rate.

Density zones are designated by wire center in the National Exchange Carrier Association, Inc., Tariff F. C. C. No. 4.

(C)

(C)

3. CARRIER COMMON LINE ACCESS SERVICE

3.7 RATE TERMS AND CONDITIONS (Cont'd)

3.7.5 UNMEASURED FEATURE GROUP A AND B USAGE

When Carrier Common Line Access is provided in association with Feature Group A or Feature Group B Switched Access Service in Company offices that are not equipped for measurement capabilities, an assumed average intrastate access minutes will be used to determine Carrier Common Line Access charges. These assumed access minutes are as set forth in 6.7.7, following.

3.7.6 PERCENT INTERSTATE USE (PIU)

When the customer reports interstate and intrastate use of in-service Switched Access Service, Carrier Common Line charges will be billed to Switched Access Service access minutes based on the data reported by the customer as set forth in 2.3.10, preceding, (Jurisdictional Reports), except where the Company is billing according to actuals by jurisdiction. Intrastate Switched Access Service access minutes will, after adjustment as set forth in 3.6.4, preceding (Resale), when necessary, be used to determine Carrier Common Line Charges as set forth in 3.7.7, following.

3.7.7 DETERMINATION OF RATES

After the adjustments as set forth in 3.6.4 and 3.7.6, preceding, have been applied, when necessary, to Switched Access Service access minutes, rates for the involved customer account will be determined as follows:

- A. Carrier Common Line Access rates shall not be reduced as set forth in 3.6.1, preceding, unless Switched Access rates, as set forth in 6.8, following, are applied to the customer's Switched Access Services.
- B. The terminating access per minute rate applies to all terminating access minutes of use.
- C. The originating access per minute rate applies to all originating access minutes of use.

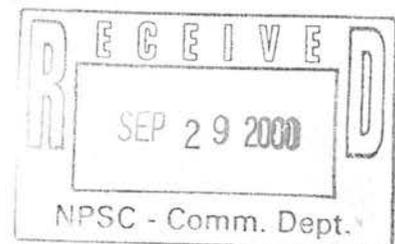

Qwest Corporation
Access Service
Catalog

SECTION 3

Page 12

Release 2

Effective: 6-16-2008

State of Nebraska
Notified: 6-5-2008

3. CARRIER COMMON LINE ACCESS SERVICE

3.8 RATES

	RATE PER ACCESS MINUTE	(D)
• Originating	\$ -	(D)
• Terminating	-	(D)

(D)

(D)

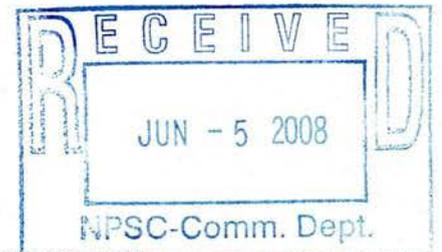

Qwest Corporation
Access Service
Catalog

State of Nebraska
Notified: 9-29-2000

SECTION 4
Index Page 1
Release 1
Effective: 9-29-2000

4. RESERVED FOR FUTURE USE

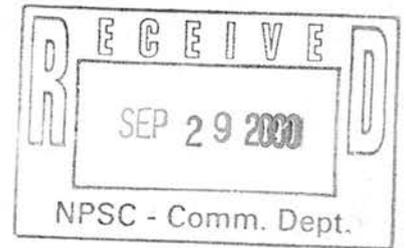

Qwest Corporation
Access Service
Catalog

SECTION 5
Index Page 1
Release 1
Effective: 9-29-2000

State of Nebraska
Notified: 9-29-2000

5. ORDERING OPTIONS FOR ACCESS SERVICES

SUBJECT	PAGE
Access Order Modifications	13
Access Order Service Date Intervals	12
Cancellation of an Access Order	18
Design Change Charge	15
Discontinuance of Access Service	23
Expedited Order Charge.....	16
General	1
Minimum Period	21
Minimum Period Charges	23
Ordering Conditions	1
Provision of Other Services	2
Selection of Facilities for Access Orders	21
Service Date Change.....	14
Shared Use Facilities	23
Special Construction	2

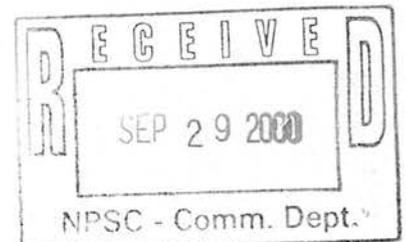

Qwest Corporation
Access Service
Catalog

SECTION 5

Page 1

Release 1

State of Nebraska
Notified: 9-29-2000

Effective: 9-29-2000

5. ORDERING OPTIONS FOR ACCESS SERVICES

5.1 GENERAL

This section sets forth the terms, conditions and order related charges for Switched Access Service and Expanded Interconnection (EI) Service. These charges are in addition to other applicable charges as set forth in other sections of this Catalog.

An Access Order is an order to provide the customer with Switched Access Service or EI Service. It is also used to provide changes to existing services.

5.1.1 ORDERING CONDITIONS

- A. The customer shall provide all information necessary for the Company to provide and bill for the requested service. In addition to the order information required in 5.2, following, the customer must also provide:
- Customer name and premises address(es)
 - Billing name and address (when different from customer name and address)
 - Customer contact name(s) and telephone number(s) for the following provisioning activities: order negotiation, order confirmation, interactive design, installation and billing
- B. The Company will establish a Service Date (Due Date) when the customer has placed an order for service with all the appropriate information to allow for the processing of the Access Order. The date on which the Service Date is established is the Application Date (Order Date).
- C. The time required to provision the service (i.e., the interval between the Application Date and the Service Date) is known as the Service Date Interval. The Service Date Interval is established in accordance with 5.2.1, following. The Company will provide a firm order confirmation to the customer advising the customer the Application Date and the associated Service Date Intervals for the Access Order. Access Order firm order confirmations, where possible, will reflect the customer's requested Service Date.

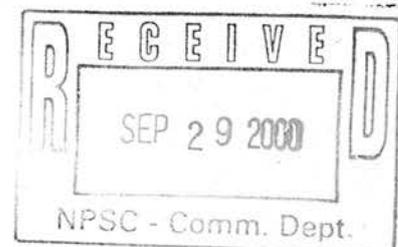

NOTICE

THE INFORMATION CONTAINED IN THIS DOCUMENT IS SUBJECT TO CHANGE.
NE2000-054

5. ORDERING OPTIONS FOR ACCESS SERVICES

5.1 GENERAL (Cont'd)

5.1.2 PROVISION OF OTHER SERVICES

- A. Other services offered under the provisions of this Catalog, shall be ordered with an Access Order or as set forth in B., following. The rates and charges for these services, as set forth in other sections of this Catalog will apply in addition to the ordering charges set forth in this section and the rates and charges for the Access Service with which they are associated.
- B. With the agreement of the Company, other services mentioned in A., preceding, may subsequently be added to the order at any time, up to and including the service date for the Access Service. When added subsequently, charges for a design change, as set forth in 5.2.2.C., following, will apply when an engineering review is required.
- C. Additional Engineering is not an ordering option, but will be applied to an Access Order when the Company determines that Additional Engineering is necessary to accommodate a customer request. Additional Engineering will only be required, as set forth in 13.1, following. When Additional Engineering is required, the customer will be so notified and will be furnished with a written statement setting forth the justification for the Additional Engineering as well as an estimate of the charges. If the customer agrees to the Additional Engineering, a firm order will be established.

If the customer does not want the service or facilities after being notified that Additional Engineering of Company facilities is required, the order will be withdrawn and no charges will apply. Once a firm order has been established, the total charge to the customer for the Additional Engineering may not exceed the estimated amount by more than ten percent (10%).

The terms, conditions, rates and charges for Additional Engineering are as set forth in 13.1, following, and are in addition to the terms, conditions, rates and charges specified in this section.

5.1.3 SPECIAL CONSTRUCTION

The rates and charges shown in this section provide for the furnishing of service where suitable facilities are available. Where special construction of facilities is necessary, additional charges may apply and will be determined on an Individual Case Basis.

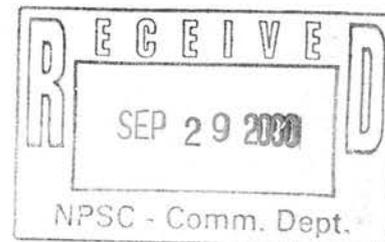

5. ORDERING OPTIONS FOR ACCESS SERVICES

5.2 ACCESS ORDER

A. Switched Access Service

When a customer requests new or additional Switched Access Services, one or more Access Orders may be required. The number of orders required is dependent on the type of services and/or facilities being requested.

When placing an order for Lineside or Trunkside Switched Access Service, the customer shall specify, at a minimum, the following:

- The type of Entrance Facility (EF), as described in 1., following;
 - The type of Direct-Trunked Transport (DTT) facility for both direct routed and tandem routed traffic, as described in 2., following;
 - The number of lines and/or trunks, as described in 3. and 4., following;
 - The basic Lineside or Trunkside Switched Access Service arrangement information as described in 3. and 4., following, respectively.
1. When the customer orders an EF for Switched Access Service (as described in 6.1.2, following), the customer must specify the customer-designated premises and the type of facility, DS3, DS1 or Voice Grade, being requested between the customer's premises and the serving wire center (SWC) of that premises. The customer shall specify their facility terminating interface and the appropriate multiplexing options, if desired, at the SWC.

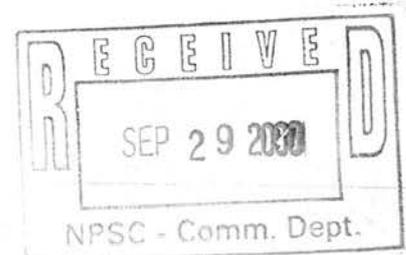

5. ORDERING OPTIONS FOR ACCESS SERVICES

5.2 ACCESS ORDER

A.1. (Cont'd)

When a Voice Grade EF is ordered, the customer shall order the associated Lineside or Trunkside Service (as set forth in 3. and 4., following) and the DTT facility (as set forth in 2., following) at the same time. When a DS1 or DS3 EF and/or DTT is being requested, the customer has the option of ordering the Lineside or Trunkside Service at the same time or the customer may order the Lineside or Trunkside Service subsequent to ordering the EF or DTT facility when one of the following conditions exist:

- A DS3 EF is ordered with a DS3 to DS1 Multiplexer at the SWC, or
- A DS3 EF is ordered with a DS3 to DS1 Multiplexer at the SWC and DS1 DTT is ordered to a specific end office, Company Hub or access tandem, or
- A DS3 EF is ordered to the SWC and a DS3 DTT facility, with a DS3 to DS1 Multiplexer, is ordered to a specific end office, Company Hub or access tandem, or
- A DS1 EF is ordered with a DS1 to Voice Grade Multiplexer at the SWC, or
- A DS1 EF and a DS1 DTT are ordered to a specific end office, Company Hub or access tandem.

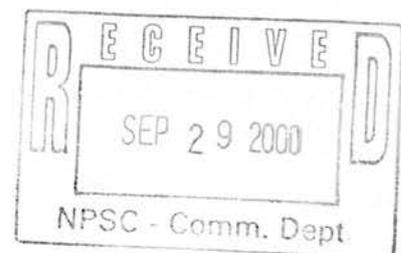

Qwest Corporation
Access Service
Catalog

SECTION 5

Page 5

Release 1

Effective: 9-29-2000

State of Nebraska
Notified: 9-29-2000

5. ORDERING OPTIONS FOR ACCESS SERVICES

5.2 ACCESS ORDER

A. Switched Access Service (Cont'd)

2. When the customer orders DTT (as described in 6.1.2, following), for either tandem routed or direct routed traffic, the customer must specify whether the EF that interfaces with the DTT facility is new or existing. If the EF is new, the customer shall order the EF as described in 1., preceding. If the EF is existing, the customer shall provide the Circuit Facility Assignment (CFA) of the existing facilities that will be utilized for the DTT. The EF capacity must be the same capacity as the DTT or higher. The customer shall specify the type of DTT facility, DS3, DS1 or Voice Grade, being requested and any multiplexing options desired. When ordering a DS1 DTT facility to a Company Hub, the customer shall specify the desired multiplexing Hub selected from the National Exchange Carrier Association, Inc. Tariff F.C.C. No. 4. This tariff identifies the type(s) of multiplexing functions which are available for a DS1 facility. When the customer desires DS3 to DS1 multiplexing/hubbing arrangements, the Company will work cooperatively to provide the desired multiplexing/hubbing arrangements in all wire centers. The customer may order a DTT facility prior to ordering Lineside or Trunkside Service only as set forth in 1., preceding. If one of the conditions in 1., preceding, is not met, the customer must order Lineside or Trunkside Service at the same time the DTT facility is ordered as set forth in 3. and 4., following.

When tandem routing is to be utilized for Trunkside Access, a DTT facility is required between the serving wire center and the access tandem and TST (common transport) is required between the access tandem and all the end offices subtending that tandem. The TST common transport facilities are provided by the Company based on the number of trunks being requested by the customer as set forth in 4., following.

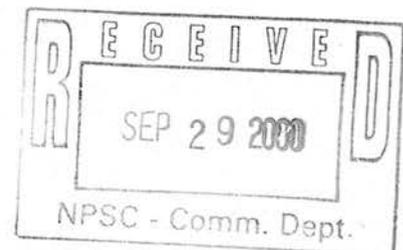

NOTICE

THE INFORMATION CONTAINED IN THIS DOCUMENT IS SUBJECT TO CHANGE.
NE2000-054

5. ORDERING OPTIONS FOR ACCESS SERVICES

5.2 ACCESS ORDER

A. Switched Access Service (Cont'd)

3. When the customer orders Lineside Switched Access Service, the customer must have capacity available on an existing EF and/or DTT facility with compatible interfaces or request an EF and/or DTT facility as described in 1. and 2., preceding. Tandem routing is not available for Lineside Switched Access. When the EF and/or DTT facility is existing, the customer shall provide the CFA of the facility to be utilized. The customer shall also specify the number of lines, the first point of switching (i.e., dial-tone office), the directionality of the service and the Switched Transport and Local Switching options desired. When additional information is required, either to apply credits or to measure and bill Lineside service properly, the customer shall specify whether the ordered line(s) will be used for resale purposes or not for resale purposes. When the service is for resale purposes, the customer shall also specify which lines are to be arranged in multiline hunt group arrangements and which lines are to be provided as single lines.
4. When the customer orders Trunkside Switched Access Service, the customer must have capacity available on an existing EF with a compatible interface or request an EF as described in 1., preceding. In addition, the customer must specify if direct routing or tandem routing is to be utilized.

When direct routing is being requested, the customer must have an existing DTT facility between the serving wire center and the end office or order a new DTT facility as described in 2., preceding. If the DTT facility is existing, the customer shall provide the CFA of the facility to be utilized.

When tandem routing is to be utilized, a DTT facility is required between the serving wire center and the access tandem and TST (common transport) is required between the access tandem and all the end offices subtending that tandem. If the DTT facility is new, the customer may order the DTT facility as described in 2., preceding. If the DTT facility is existing, the customer shall provide the CFA of the facility to be utilized. The TST common transport facilities are provided by the company based on the number of trunks being requested as set forth following.

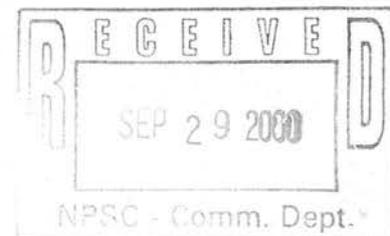

NOTICE

THE INFORMATION CONTAINED IN THIS DOCUMENT IS SUBJECT TO CHANGE.
NE2000-054

5. ORDERING OPTIONS FOR ACCESS SERVICES

5.2 ACCESS ORDER

A.4. (Cont'd)

Trunkside Switched Access Service must be ordered in trunks. The customer is responsible to assure that sufficient access facilities have been ordered to handle its traffic. On the order for service, the customer shall specify the number of trunks, the end office, if direct routing or tandem routing is desired, Switched Transport options and Local Switching options desired.

The number of trunks may be determined by the customer in the following manner. For each day the customer shall determine the highest number of trunks required to handle its traffic during a single hour. The customer shall, for the same hour period (i.e., busy hour), pick the twenty consecutive business days in a calendar year which add up to the largest number of trunks required to handle its traffic. The customer shall then determine the average busy hour trunks by dividing the largest number of trunks in use figure, for the same hour period, for the consecutive twenty business day period by 20. This computation shall be performed for each end office and/or access tandem the customer wishes to serve.

When ordering trunks to an access tandem, the customer must also provide the Company an estimate of the amount of traffic it will generate to and/or from each end office subtending the access tandem to assist the Company in its own efforts to project further facility requirements. In addition, the customer shall also specify for terminating only access, whether the trunks are to be arranged in trunk group arrangements or provided as single trunks. The traffic type must also be specified using the same categories as described in 6.1.1, following, to enable efficient provisioning and billing functions.

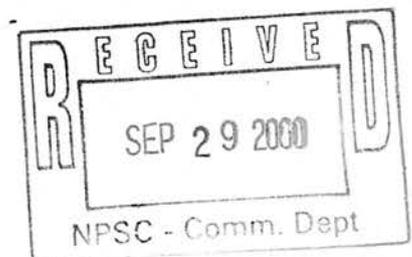

NOTICE

THE INFORMATION CONTAINED IN THIS DOCUMENT IS SUBJECT TO CHANGE.
NE2000-054

Qwest Corporation
Access Service
Catalog

SECTION 5

Page 8

Release 1

State of Nebraska
Notified: 9-29-2000

Effective: 9-29-2000

5. ORDERING OPTIONS FOR ACCESS SERVICES

5.2 ACCESS ORDER

A. Switched Access Service (Cont'd)

5. For 900 Access Service, the customer shall order the service in accordance with the preceding provisions as set forth in 1., 2. and 4., preceding, and the manner in which the service is to be provisioned as set forth in 6.2.6, following, except that customers may request DTT to only those offices designated by the Company as 900 Access Service screening offices. Additionally, when new NXX(s) are to be opened in a LATA or when existing NXX(s) are to be deleted, and such change is to occur coincident with the Service Date established for the order, the customer shall provide such information when placing the order for the service. The customer shall notify the Company of all NXX code activity (activation or deactivation) as set forth in 6.6.2.C., following, regardless of whether the activity is to occur with or without a requirement for additional capacity (i.e., BHMC or quantities of trunks). All 900 number assignments and administration shall be in accordance with the North American Numbering Plan (NANP).

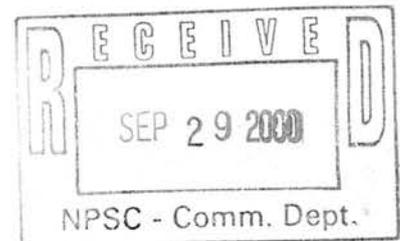

5. ORDERING OPTIONS FOR ACCESS SERVICES

5.2 ACCESS ORDER

A. Switched Access Service (Cont'd)

6. For 800 Data Base (800 DB) Access Service, the customer shall order the service in accordance with the requirements as set forth in 1., 2. and 4., preceding. The service will be provisioned as set forth in 6.2.5, following, except that customers may request DTT to those end offices designated by the Company as Service Switching Points (SSPs). 800 DB Access Service is available only as a LATA-wide service and must be ordered to all end offices in a LATA. Service will be provisioned, at a minimum, to all access tandems and operator switches equipped as SSPs in a LATA. 8XX codes and number assignments shall be in accordance with the Guidelines for 800 Data Base.
7. When a customer orders CCSAC, the customer must specify the customer's STP premises, the number of CCS Links required between the customer's Signaling Point of Interface (SPOI) and the Company's STP location per Access Order as set forth in Section 15, following.
8. When a customer orders FGD Service with the SS7 Out of Band Signaling feature, the customer must specify the CCSAC Service required between the customer's SPOI and the Company's STP location per Access Order as set forth in Section 15, following. Separate orders shall be issued for the CCSAC Service and the associated FGD service.
9. Customers, when placing an order for Switched Access Services FGB or FGD, may request one or more Carrier Identification Codes (CIC) on the same Access Order. The first CIC is included in the nonrecurring charge for the Access Order. Each additional (i.e., two or more) CIC requested on the same Access Order is assessed a service rearrangement nonrecurring charge as set forth in 6.7.1, following.

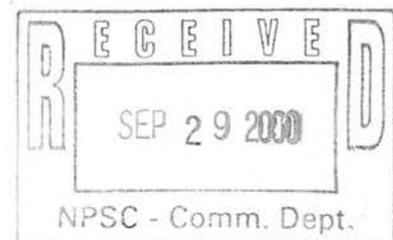

NOTICE

THE INFORMATION CONTAINED IN THIS DOCUMENT IS SUBJECT TO CHANGE.
NE2000-054

Qwest Corporation
Access Service
Catalog

SECTION 5

Page 10

Release 1

State of Nebraska
Notified: 9-29-2000

Effective: 9-29-2000

5. ORDERING OPTIONS FOR ACCESS SERVICES

5.2 ACCESS ORDER

A. Switched Access Service (Cont'd)

10. When a customer desires Switched Access Service to an end office that is a remote switching office, the customer must order service to and/or from the host office which controls the remote switching office since all traffic to and/or from a remote switching office must be routed through the host office.
 11. For Voice DA Service, the customer shall specify the number of trunks from the SWC of the customer's premises to the Voice DA location. If the Voice DA Service is to be combined with a Trunkside Switched Access Service, the customer shall also specify which trunk group is to be associated with the Voice DA Service. This information is used to determine the number of transmission paths as set forth in 9.2.1.C., following. The customer then specifies the Directory Transport options. For purposes of applying the order regulations, a Voice DA location is considered to be a customer/end user SWC.
- B. For virtual EI Service, the customer must specify the Company central office in which the virtual interconnector's equipment will be installed, and the type of EI Channel Termination, the channel interface, technical specification package and options desired.**



Qwest Corporation
Access Service
Catalog

SECTION 5
Page 11
Release 2
Effective: 7-1-2016

State of Nebraska
Notified: 6-1-2016

5. ORDERING OPTIONS FOR ACCESS SERVICES

5.2 ACCESS ORDER (Cont'd)

- C. For WATS Access Service provided on a dual jurisdiction basis; i.e., interstate and intrastate, the WATS access line and associated WATS Access Service options are provided subject to the terms and conditions of the Company's interstate Access Service Tariff F.C.C. No. 11. The intrastate FGC or FGD Switched Access Service provided in conjunction with WATS Access Service shall be ordered as set forth in this section. (T)

For WATS Access Service provided on a Shared WATS basis; i.e., intrastate interLATA and intrastate intraLATA, the service will be provided jointly by the Company and the Interexchange Carrier. The WATS access line is provided subject to the terms and conditions of the Company's Exchange and Network Services Tariff, Section 7. The Company provides the WATS access line, transports the intraLATA traffic and bills both the WATS access line and intraLATA usage to the end user out of the Company's Exchange and Network Services Tariff. The Interexchange Carrier transports the interLATA traffic and bills interLATA usage to the end user at the IC's applicable WATS usage rates. The intrastate FGC or FGD Switched Access Service provided in conjunction with WATS Access Service shall be ordered as set forth in this section.

- D. For 800 Service provided on a Complementary basis; i.e., intrastate interLATA and intrastate intraLATA, the service may be provided jointly by the Company and the Interexchange Carrier. The 8XX number is provided subject to the terms and conditions of the Company's Exchange and Network Services Catalog, Section 7. The Company provides the 8XX number to be associated with an individual line or trunk, transports the intraLATA traffic and bills both the 8XX number and intraLATA usage to the end user out of the Company's Exchange and Network Services Catalog. The Interexchange Carrier transports the interLATA traffic and bills interLATA usage to the end user at the IC's applicable WATS usage rates. The intrastate Trunkside Switched Access Service provided in conjunction with the 800 Service shall be ordered as set forth in this section.

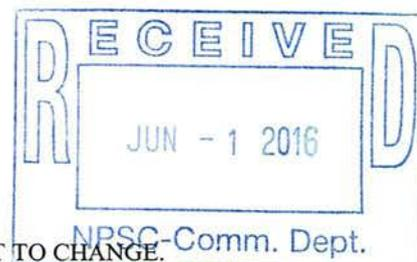

5. ORDERING OPTIONS FOR ACCESS SERVICES

5.2 ACCESS ORDER (Cont'd)

5.2.1 ACCESS ORDER SERVICE DATE INTERVALS

Access Service is provided with one of the following Service Date Intervals:

- Standard Interval
- Negotiated Interval

Service interval tables and any associated relevant information can be found in the Service Interval Guide and will be provided to all customers within a reasonable time of request, whether the customer's service is subject to standard or negotiated intervals.

To the extent the Access Service can be made available with reasonable effort, the Company will provide the Access Service in accordance with the customer's requested interval, subject to the following conditions:

A. Standard Interval

1. A schedule of Standard Intervals applicable for Switched Access is included in the Service Interval Guide mentioned above. The schedule specifies the services and the quantities that can be provided within Standard Intervals.
2. Access Services provided in a Standard Interval will be installed during Company business days. If a customer requests that installation be done outside of normally scheduled work hours, and the Company agrees to the request, the customer will be subject to applicable Additional Labor Charges as set forth in 13.4, following.

B. Negotiated Interval

The Company will negotiate a Service Date Interval with the customer on an Individual Case Basis (ICB), when:

- There is no Standard Interval for the service,
- The quantity of Access Services ordered exceeds the quantities specified in the Standard Intervals described in the Service Interval Guide, or
- The customer requests a service date before or beyond the applicable Standard Interval service date.

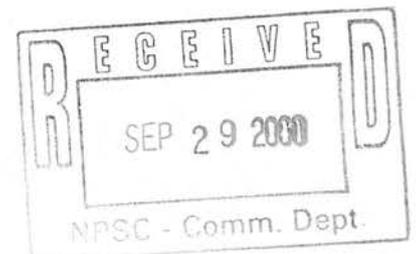

NOTICE

5. ORDERING OPTIONS FOR ACCESS SERVICES

5.2 ACCESS ORDER

5.2.1 ACCESS ORDER SERVICE DATE INTERVALS

B. Negotiated Interval (Cont'd)

The Company will offer a Service Date based on the type and quantity of Access Services the customer has requested. The Negotiated Interval may not exceed by more than six (6) months the Standard Interval Service Date, or, when there is no Standard Interval, the Company offered Service Date.

All services for which rates are applied on an Individual Case Basis are provided with a Negotiated Interval.

The schedule in the Service Interval Guide specifies the services that will be provided on a Negotiated Interval.

Access Services provided on a Negotiated Interval will be installed during Company business days. If a customer requests that installation be done outside of normally scheduled work hours, and the Company agrees to their request, the customer will be subject to applicable Additional Labor charges as set forth in 13.4, following.

5.2.2 ACCESS ORDER MODIFICATIONS

The customer may request a modification of its Access Order at any time prior to notification by the Company that service is available for the customer's use. The Company will make every effort to accommodate a requested modification when it is able to do so with the normal work force assigned to complete such an order within normal business hours.

If the modification cannot be made with the normal work force during normal business hours, the Company will notify the customer. If the customer still desires the Access Order modification, the Company will schedule a new Service Date. All charges for Access Order modifications will apply on a per-occurrence basis.

Any increase in the number of Switched Access Service facilities, lines, trunks or EI Channel Terminations will be treated as a new Access Order (for the increased amount only).

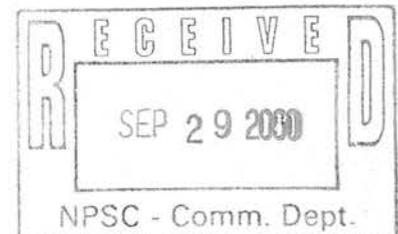

Qwest Corporation d/b/a CenturyLink QC
Access Service
Catalog

SECTION 5
Page 14
Release 3
Effective: 03-31-2017

(C)

State of Nebraska
Notified: 03-20-2017

5. ORDERING OPTIONS FOR ACCESS SERVICES

5.2 ACCESS ORDER

5.2.2 ACCESS ORDER MODIFICATIONS (Cont'd)

A. Service Date Change

Access Order Service Dates for the installation of new services or rearrangements of existing services may be changed, but the new Service Date may not exceed the original Service Date by more than sixty (60) calendar days. When, for any reason, the customer wishes to change the Service Date the customer should notify the Company before the original Service Date to request a different Service Date. If the customer requested Service Date is more than sixty (60) calendar days after the original Service Date, the order will be canceled by the Company and reissued with the appropriate cancellation charges applied, unless the customer indicates that billing for the service is to commence as set forth in 5.2.3, following.

(C)

(C)

A new Service Date may be established that is prior to the original Standard or Negotiated Interval Service Date if the Company determines it can accommodate the customer's request without delaying Service Dates for orders of other customers.

If the Service Date is changed to an earlier date, the customer will be notified by the Company that Expedited Order Charges as set forth in the Private Line Transport Services Catalog, will apply.

B. Partial Cancellation Charge

Any decrease in the number of ordered Switched Access Service facilities, lines, trunks or EI Channel Terminations will be treated as a partial cancellation and the charges as set forth in 5.2.3, following, will apply.

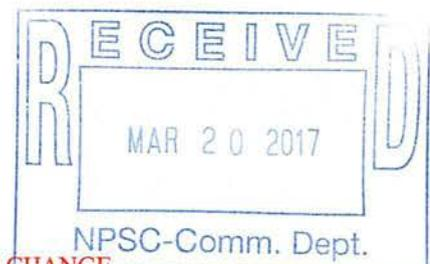

5. ORDERING OPTIONS FOR ACCESS SERVICES

5.2 ACCESS ORDER

5.2.2 ACCESS ORDER MODIFICATIONS (Cont'd)

C. Design Change Charge

The customer may request a design change to the service ordered. A design change is any change to an Access Order which requires engineering review. An engineering review is a review by Company personnel of the service ordered and the requested changes to determine what change in the design, if any, is necessary to meet the changes requested by the customer. Design changes include such things as a change of end user's premises within the same SWC, the addition or deletion of optional features or functions or a change in the type of Transport Termination (Switched Access only), type of channel interface, type of Interface Group or technical specification package.

Design changes do not include a change of customer's premises, end user's premises to a different SWC, end office switch, Switched Access Service type or EI Channel Termination. Changes of this nature will require the issuance of a new order and the cancellation of the original order with appropriate cancellation charges applied.

The Company will review the requested change, notify the customer whether the change is a design change, if it can be accommodated and if a new service date is required. If the customer authorizes the Company to proceed with the design change, a Design Change Charge will apply.

A Design Change Charge will apply, on a per order, per occurrence basis. This charge will also apply to change an incorrect address as long as the new address is in the same wire center as the incorrect address and the change is made prior to the issuance of the Design Layout Report (DLR). If a change of end user's premises within the same SWC is requested, Expedited Order Charges may also apply as set forth in the Private Line Transport Services Catalog. The applicable design charge is:

	CHARGE	(T)
• Design Change Charge, per order	\$103.00	(T)

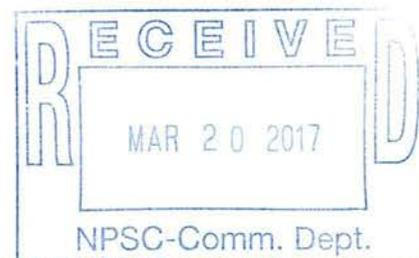

NOTICE

THE INFORMATION CONTAINED IN THIS DOCUMENT IS SUBJECT TO CHANGE.

Qwest Corporation
Access Service
Catalog

SECTION 5
Page 16
Release 2

State of Nebraska
Notified: 7-22-2004

Effective: 8-2-2004

5. ORDERING OPTIONS FOR ACCESS SERVICES

5.2 ACCESS ORDER

5.2.2 ACCESS ORDER MODIFICATIONS (Cont'd)

- D. Expedited Order Charges for Access Orders are set forth in the Private Line Transport Services Catalog.

If costs other than additional labor are to be incurred when an Access Order is expedited, the Company will develop, determine and bill the customer such costs in accordance with the special construction terms and conditions as set forth in 5.1.3, preceding.

(C)
(C)
(D)
(M)
|
(M)

(M) Material moved from Page 17.

Qwest Corporation
Access Service
Catalog

SECTION 5

Page 17

Release 2

State of Nebraska
Notified: 7-22-2004

Effective: 8-2-2004

5. ORDERING OPTIONS FOR ACCESS SERVICES

5.2 ACCESS ORDER

5.2.2 ACCESS ORDER MODIFICATIONS

(D)

(D)

(M)

(M) Material moved to Page 16.

State of Nebraska
Notified: 03-20-2017

5. ORDERING OPTIONS FOR ACCESS SERVICES

5.2 ACCESS ORDER (Cont'd)

5.2.3 CANCELLATION OF AN ACCESS ORDER

A. A customer may cancel an Access Order for the installation of service at any time prior to notification by the Company that service is available for the customer's use. The cancellation date is the date the Company receives written or verbal notice from the customer that the order is to be canceled. The verbal notice must be followed by written confirmation within ten (10) days. If a customer or a customer's end user is unable to accept Access Service within thirty (30) calendar days after the latest agreed upon service date, the following will occur:

(C)
(C)

- The Access Order shall be canceled and charges as set forth in D. and E., following, will apply if the service has not been fully provisioned, or
- The Access Order will be completed and billing for the service will commence if the service has been fully provisioned or the customer has indicated that billing for the service should begin..

(T)
(C)

(C)
(C)

(D)
(D)

B. Service Date Intervals are associated with the provisioning of an Access Order whether standard or negotiated as set forth in 5.2.1, preceding. Certain Critical Dates, as set forth in E., following, are used by the Company to monitor the service order provisioning progress. The Company includes these scheduled Critical Dates in the firm order confirmation associated with each Access Order provided to the customer. Cancellation charges are based on the estimated costs incurred by the Company at the time the order is canceled. The Company monitors which Critical Date was last scheduled and what percentage of the Company's provisioning costs have been incurred as of that Critical Date. A Cancellation Charge will not apply if the scheduled Service Date has not been provided to the customer.

Costs incurred in conjunction with the provision of Switched Access Service start on the Application Date defined in C., following. When a customer cancels an Access Order prior to the Application Date, no charges shall apply. When a customer cancels an Access Order or part of an Access Order, on or after the Application Date, a charge equal to the estimated costs incurred by the Company shall apply as set forth in D. and E., following. When a customer cancels an Access Order or part of an Access Order, on or after the original Service Date, the Cancellation Charge will apply as set forth in D. and E., following.



5. ORDERING OPTIONS FOR ACCESS SERVICES

5.2 ACCESS ORDER

5.2.3 CANCELLATION OF AN ACCESS ORDER (Cont'd)

- C. The Critical Dates monitored by the Company for the purpose of calculating a Cancellation Charge are as follows:
1. Application Date (APP): The date the customer provides a firm commitment and sufficient information as detailed in 5.1.1, preceding. The APP Date is the date the Company enters the order into the Company's order distribution system. This is sometimes referred to as the order date.
 2. Design Layout Report Date (DLRD): The date the Design Layout Report which contains the design for the service(s) ordered is forwarded to the customer.
 3. Plant Test Date (PTD): The date acceptance testing is performed with the customer.
 4. Service Date (DD): The date the service is due to be made available to the customer. This is sometimes referred to as the Due Date.
- D. The percentage of the total provisioning cost incurred by the Company at a particular Critical Date varies by the type of service as shown in E., following.

When a customer cancels an Access Order, or part of an Access Order, before the Service Date, the Company will calculate the Cancellation Charge by multiplying all the nonrecurring charges associated with the Access Order, or that part of the Access Order being canceled, by the percentage shown in E., following, based on the last monitored Critical Date which has occurred on the Access Order. When a customer cancels an Access Order or part of an Access Order on or after the original Service Date, 100% of the nonrecurring charges plus minimum period charges apply.

Nonrecurring charges associated with an Access Order are used to calculate and bill the Cancellation Charge to the customer even when nonrecurring charges are waived.

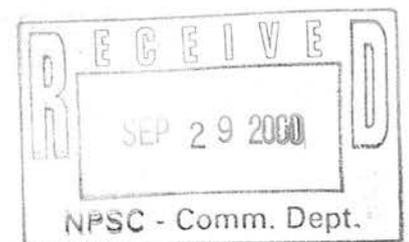

Qwest Corporation
Access Service
Catalog

SECTION 6
Page 20
Release 2
Effective: 7-1-2016

State of Nebraska
Notified: 6-1-2016

6. SWITCHED ACCESS SERVICE

6.1 GENERAL
6.1.2 RATE CATEGORIES
A.3. (Cont'd)

Only certain Network Channel Interface codes (NCI) are available at the customer's premises. The NCI codes associated with the Interface Groups may vary among different types of service based on the technical requirements. The various premises interfaces which are available with the Interface Groups, and the types of service with which they may be used, are set forth in e., following.

Based upon the Interface Group chosen by the customer, EF and DTT multiplexing arrangements may be required. Multiplexing arrangements are described in 4., following.

When Switched Access Services are ordered in conjunction with Private Line Transport DS3 Service which is provisioned with an Electrical capacity of two or greater or any Optical Interface ordered and provided from Section 7 of the Interstate Access Service Tariff F.C.C. No. 11, the common interface will be provisioned under the rules and regulations for Shared Use between Private Line Transport and Switched Access Services referenced in 2.7, preceding. The rate for DS3 EF Electrical capacity of two or greater or any Optical Interface is for the billing of Shared Use only. Switched Access Services rates and charges as set forth in 6.8, following will apply for each channel of the Shared Use facility that is used to provide Switched Access Service. Technical specifications are delineated in Qwest Corporation Technical Reference 77324.

(T)

When Interface Groups 1, 2, 6 or 9 are associated with FGD Service with SS7 out of band signaling, no signaling will be done via the message channel.

When *SWITCHNET 56* Service is ordered in conjunction with FGD, it requires the use of a separate trunk group equipped with Interface Group 6. This service allows a customer to establish a connection between the customer's premises and a suitably equipped end user premises over facilities capable of transmitting digital data at 56 kbps.

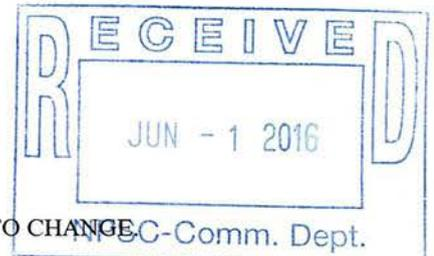

5. ORDERING OPTIONS FOR ACCESS SERVICES

5.2 ACCESS ORDER (Cont'd)

5.2.4 SELECTION OF FACILITIES FOR ACCESS ORDERS

When a customer places an order for Lineside or Trunkside Switched Access Service, the customer may choose to utilize existing Switched Access Entrance Facilities and/or Direct-Trunked Transport facilities ordered from Section 6, following, or Private Line Transport Service (PLTS) facilities. Shared Use is allowed when Shared Use facilities are ordered and provided as set forth in 2.7, preceding. The customer is not allowed to order Switched Access facilities from Section 6 and assign PLTS to those facilities. The customer must specify the specific channels to be used to implement the Access Order.

5.2.5 MINIMUM PERIOD

- A. Except as set forth in B., C. and 9.4.A., following, the minimum period for which Access Service is provided and for which charges are applicable, is one month.
- B. The minimum period for Switched Access Service Feature Group D, 800 DB Access Service, 900 Access Service, DS3 and DS1 Entrance Facilities and DS3 and DS1 DTT facilities associated with such services is three months.
- C. Service Rearrangements as set forth in 6.7.1.C., following for Switched Access Service, may be made without a change in minimum period requirements.

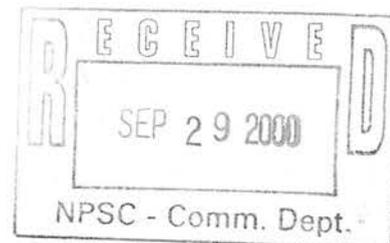

5. ORDERING OPTIONS FOR ACCESS SERVICES

5.2 ACCESS ORDER

5.2.5 MINIMUM PERIOD (Cont'd)

- D. Changes other than those identified in 6.7.1.C. and 6.7.6., following, will be treated as a discontinuance of the existing service and an installation of a new service. All associated nonrecurring charges will apply for the new service. A new minimum period will be established for the new service. The customer will also remain responsible for all outstanding minimum period obligations associated with the disconnected service.

The changes listed below are those which will be treated as a discontinuance and installation of service and for which a new minimum period will be established.

1. A change of customer of record (i.e., Access Service is provided to and billed to a different entity), except as provided for in 6.7.1.C.3., following.
2. A change in type of service (i.e., Switched Access to Private Line Transport Service or one type of Switched Access Service to another, except as set forth in 6.7.4 and 6.7.5, following).
3. A change in Switched Access Service or Voice DA Service Interface Group, except as set forth in 6.7.4, following.
4. A change in Switched Access Service traffic type. When FGD Service is rearranged as set forth in 6.7.1, following, a change in traffic type may occur without a discontinuance of the existing service and an installation of new service. No new minimum period will be required.
5. Any change in CCSAC Service other than a change in jurisdiction.
6. A change in capacity of a Switched Access Service or Directory Assistance Service Entrance Facility or DTT facility (e.g., a change from a DS1 Entrance Facility to a DS3 Entrance Facility), except as set forth in 6.7.1, following.
7. A change in Switched Access Service or Directory Assistance Service type of transport (e.g., a change from TST to DTT), except as set forth in 6.7.1, following.

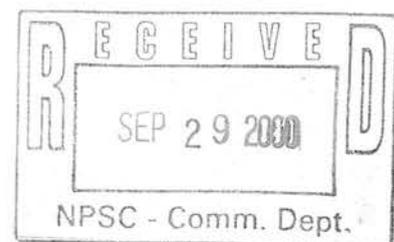

NOTICE

THE INFORMATION CONTAINED IN THIS DOCUMENT IS SUBJECT TO CHANGE.
NE2000-054

5. ORDERING OPTIONS FOR ACCESS SERVICES

5.2 ACCESS ORDER (Cont'd)

5.2.6 MINIMUM PERIOD CHARGES

When Access Service is discontinued prior to the expiration of the minimum period, charges are applicable for the balance of the minimum period.

The Minimum Period Charge for monthly billed services will be determined as follows:

- A. For Switched Access Service, the charge for a month or fraction thereof is equal to the applicable minimum monthly charge for the capacity as set forth in 6.7.3, following.
- B. The Minimum Period Charge for Feature Group D Switched Access Service and the associated Entrance Facility and DTT facility will be determined as set forth in 2.4.2, preceding.
- C. For EI Service, the charge for a month or fraction thereof is the applicable monthly rates for the service as set forth in Section 21, following.
- D. All applicable nonrecurring charges and discontinuance charges for the service will be billed in addition to the Minimum Period Charge.

5.2.7 SHARED USE FACILITIES

When a customer orders Switched Access Service on a Private Line Transport Service Shared Use Facility as set forth in 2.7, preceding, the customer must specify on its order a channel facility assignment for each service ordered.

5.2.8 DISCONTINUANCE OF ACCESS SERVICE

A customer may cancel an Access Service at any time. The Company requires two (2) business days' notice for the cancellation of an Access Service. The notice can be written or verbal, however a verbal notice must be followed by a written confirmation within ten (10) days. The notice period will begin at the time of the verbal notice. If there is no verbal notice, the notice period begins at the time the written request is received.

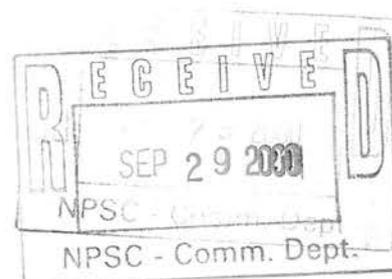

NOTICE

THE INFORMATION CONTAINED IN THIS DOCUMENT IS SUBJECT TO CHANGE.
NE2000-054

Qwest Corporation
Access Service
Catalog

SECTION 6
Index Page 1
Release 2
Effective: 02-15-2001

State of Nebraska
Notified: 02-05-2001

6. SWITCHED ACCESS SERVICE

SUBJECT	PAGE
800 Data Base Access Service	61
900 Access Service	65
Acceptance Testing	35
Application of Rates for Extension Service	128
Change of Switched Access Interface Group Category	113
Change of Switched Access Service Type	114
Common Switching Optional Features	67
Common Switching, Transport Termination and Line Termination Optional Features	67
Description and Application of Rates and Charges	94
Design and Traffic Routing of Switched Access Service	86
Design Blocking Probability	88
Design Layout Report	34
Design of Switched Access Services	93
Determination of Number of End Office Transport Terminations	88
Determination of Number of Transmission Paths	87
End User Line and Usage Information Data	91
Feature Group A (FGA)	37
Feature Group B (FGB)	44
Feature Group C (FGC)	48
Feature Group D (FGD)	54
General	1
Local Information Delivery Services	128
Local Switching	145

(D)

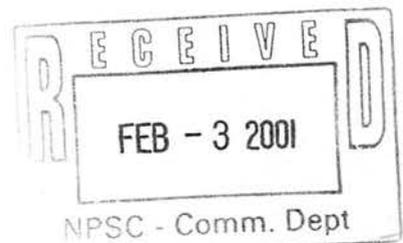

Qwest Corporation
Access Service
Catalog

SECTION 6
Index Page 2
Release 1

State of Nebraska
Notified: 9-29-2000

Effective: 9-29-2000

6. SWITCHED ACCESS SERVICE

SUBJECT	PAGE
Measuring Access Minutes	121
Message Unit Credit	128
Mileage Measurement	129
Minimum Monthly Charge	112
Minimum Periods	112
Moves	115
Multiplexing.....	86
Network Management	85
Obligations of the Company	85
Obligations of the Customer	92
Ordering Options and Conditions	35
Percent Direct Routed Factor.....	133
Provision and Description of Switched Access Service	35
Provision of Service Performance Data	87
Rate Categories	3
Rate Terms and Conditions	94
Rates and Charges	134
Report Requirements	92
Shared Use	132
Special Facilities Routing	34
Special High Voltage Protective Apparatus	35
Supervisory Signaling	93
Switched Access Service Arrangements and Manner of Provision	1
Switched Transport.....	134
Transmission Specifications	84
Transport Termination Optional Features	81
Trunk Group Measurement Reports	87
Trunk Group Measurements Reports	93

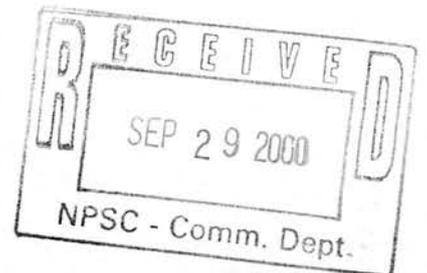

6. SWITCHED ACCESS SERVICE

6.1 GENERAL

Switched Access Service, which is available to customers for their use in furnishing their services to end users, provides a two-point electrical communications path between a customer's premises and an end user's premises. It provides for the use of terminating, switching, transport facilities and common subscriber plant of the Company. Switched Access Service provides for the ability to originate calls from an end user's premises to a customer's premises, and to terminate calls from a customer's premises to an end user's premises in the LATA where it is provided. Specific references to material describing the elements of Switched Access Service are provided in 6.1.1 and 6.1.2, following.

Rates and charges for Switched Access Service are set forth in 6.8, following. The application of rates for Switched Access Service is described in 6.7, following. Rates and charges for service other than Switched Access Service, e.g., a customer's interLATA toll message service, may also be applicable when Switched Access Service is used in conjunction with these other services. Descriptions of such applicability are provided in 6.2.1.A.8., 6.2.1.B.4., 6.2.2.A.7., 6.2.2.B.3., 6.2.3.A.7., 6.2.4.A.5., 6.7.8 and 6.7.10, following. Finally, a credit is applied against lineside Switched Access Service charges as described in 6.7.9, following.

6.1.1 SWITCHED ACCESS SERVICE ARRANGEMENTS AND MANNER OF PROVISION

Switched Access Services are differentiated by their technical characteristics, e.g., lineside vs. trunkside connection at the Company entry switch, and the manner in which an end user accesses them in originating calling, e.g., with or without an access code.

A. Manner of Provision

1. Lineside Access (FGA) is furnished on a per-line basis. Trunkside Access (FGs B, C and D) is furnished on a per trunk basis.
2. Trunks are differentiated by type and directionality of traffic carried over a Switched Access Service arrangement. Differentiation among traffic types is necessary for the Company to design Switched Access Service properly to meet the traffic carrying capacity requirement of the customer.

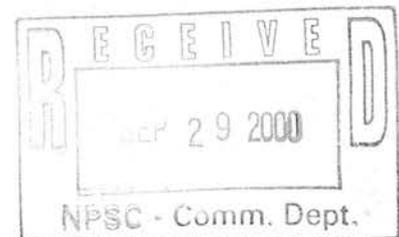

6. SWITCHED ACCESS SERVICE

6.1 GENERAL

6.1.1 SWITCHED ACCESS SERVICE ARRANGEMENTS AND MANNER OF PROVISION

A. Manner of Provision (Cont'd)

3. There are six major traffic types. These are: Originating, Terminating, Voice DA, *SWITCHNET 56*, CCC Originating and CCC Terminating.
 - Originating traffic type represents access capacity within a LATA for carrying traffic from the end user to the customer.
 - Terminating traffic type represents access capacity within a LATA for carrying traffic from the customer to the end user.
 - Voice DA traffic type represents access capacity within a LATA for carrying Voice DA traffic from the customer to a Voice DA location.
 - *SWITCHNET 56* traffic type represents access capacity in a LATA for carrying digital traffic at speeds up to 56 Kbit/s between the customer and end user.
 - CCC Originating traffic type represents access capacity within a LATA for carrying circuit switched data and/or circuit switched voice traffic on FGD Service equipped with Clear Channel Capability from the end user to the customer.
 - CCC Terminating traffic type represents access capacity within a LATA for carrying circuit switched data and/or circuit switched voice traffic on FGD Service equipped with Clear Channel Capability from the customer to the end user.

When ordering capacity for Trunkside Switched Access, the customer must, at a minimum, specify such access capacity in terms of Originating and/or Terminating traffic type, *SWITCHNET 56* traffic type, CCC Originating traffic type and/or CCC Terminating traffic type, or Voice DA Service. Voice DA Traffic Type is used for ordering Voice DA Access Service as set forth in Section 9, following. Additionally, when ordering capacity for 800 DB Access and/or 900 Access Service, the customer must specify 8XX and/or 900 traffic type.

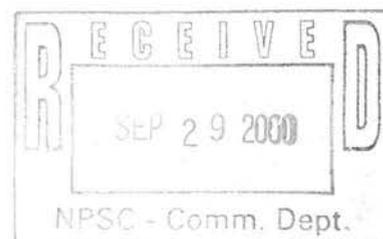

NOTICE

THE INFORMATION CONTAINED IN THIS DOCUMENT IS SUBJECT TO CHANGE.
NE2000-054

6. SWITCHED ACCESS SERVICE

6.1 GENERAL

6.1.1 SWITCHED ACCESS SERVICE ARRANGEMENTS AND MANNER OF PROVISION

A. Manner of Provision (Cont'd)

4. Because some customers will wish to segregate their originating FGC, FGD, 800 DB Access Service, or 900 Access Service traffic further into separate trunk groups, the Originating traffic type and CCC Originating traffic type are further categorized into Domestic, 8XX, 900 and Operator. Domestic traffic type represents access capacity for carrying only domestic traffic other than 8XX, 900, and Operator traffic; 8XX, 900 and Operator traffic type represents access capacity for carrying, respectively, only 8XX or Operator traffic. When such a customer wishes to segregate traffic as described above, the customer must specify Domestic, 8XX, 900 or Operator traffic type.
5. When Switched Access Service connects to Expanded Interconnection (EI) Service as set forth in Section 21, following, the Switched Access Service is provided at a DS1 or DS3 capacity connecting to an EI channel termination DS1 or DS3. A Switched Transport Entrance Facility is not required. The wire center where the Company-designated point of interconnection exists for Virtual EI will be the designated Switched Transport SWC and the customer's point of interconnection for Switched Access Services.

6.1.2 RATE CATEGORIES

There are three rate categories which apply to Switched Access Service:

- Switched Transport (described in A., following)
- Local Switching (described in B., following)
- Common Line (described in Section 3, preceding)

In addition to the three rate categories, there are rate elements applicable to certain Switched Access Services:

800 DB Access Service Charges

Applicable to 800 DB Access Service provided in conjunction with Trunkside Access. The description and application of this charge is set forth in 6.7.1, following.

900 Access Service Charges

Applicable to 900 Access provided in conjunction with Feature Groups C, D and 900 Access Service (FGB-like). The description and application of these charges are set forth in 6.7.1, following.

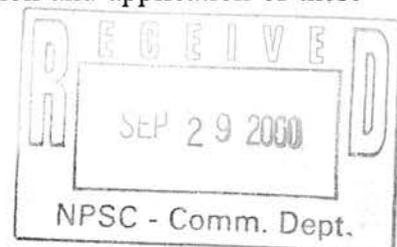

NOTICE

THE INFORMATION CONTAINED IN THIS DOCUMENT IS SUBJECT TO CHANGE.
NE2000-054

6. SWITCHED ACCESS SERVICE

6.1 GENERAL

6.1.2 RATE CATEGORIES (Cont'd)

The following diagrams depict possible serving arrangements and components of Switched Access Service and the manner in which the components are combined to provide a complete access service. The following diagrams are not intended to depict all serving arrangements available. Common line rate elements are described in Section 3, preceding.

EXAMPLE 1

Switched Access Service Ordered with Tandem Routing

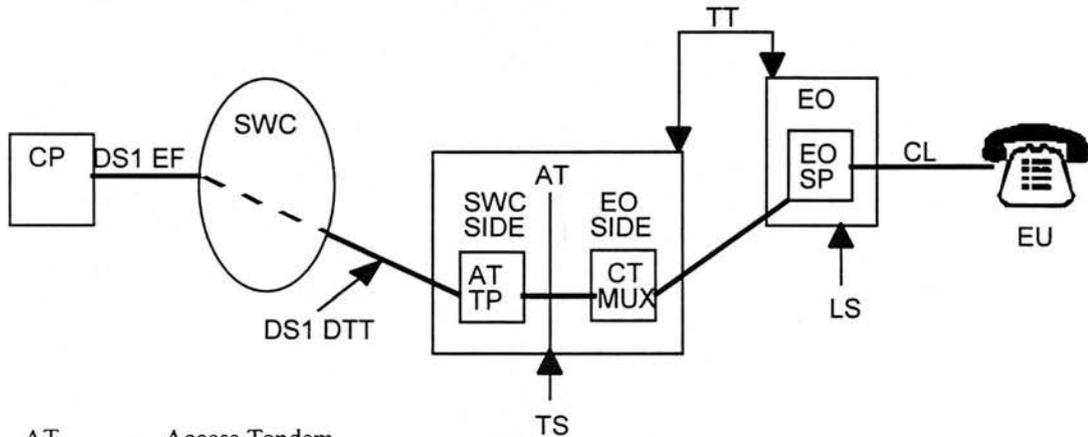

- AT - Access Tandem
- ATTP - Access Tandem Trunk Port
- CL - Common Line
- CP - Customer's Premises
- CT MUX - Common Transport Multiplexing
- DTT - Direct Trunked Transport
- EF - Entrance Facility
- EO - End Office
- EO SP - End Office Shared Port
- EU - End User
- LS - Local Switching
- SWC - Serving Wire Center
- TS - Tandem Switching
- TT - Tandem Transmission

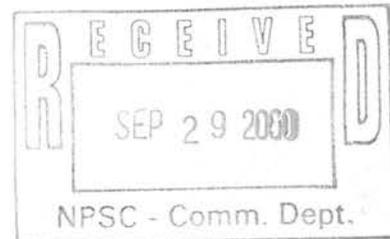

6. SWITCHED ACCESS SERVICE

6.1 GENERAL

6.1.2 RATE CATEGORIES (Cont'd)

EXAMPLE 2

Switched Access Service Ordered
with DS1 EF and DS1 DTT Facility

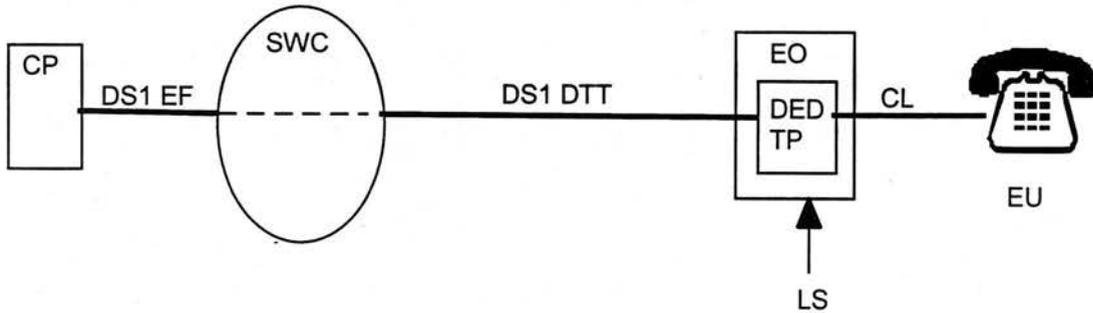

- CL - Common Line
- CP - Customer's Premises
- DED TP - Dedicated Trunk Port
- DTT - Direct Trunked Transport
- EF - Entrance Facility
- EO - End Office
- EU - End Users
- LS - Local Switching
- SWC - Serving Wire Center

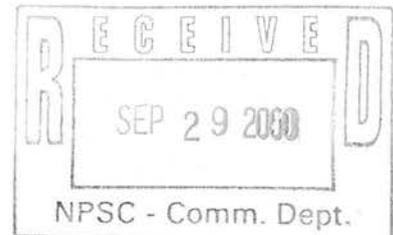

6. SWITCHED ACCESS SERVICE

6.1 GENERAL
6.1.2 RATE CATEGORIES (Cont'd)

EXAMPLE 3

**Switched Access Service Ordered
 with DS3 EF for DTT and TST**

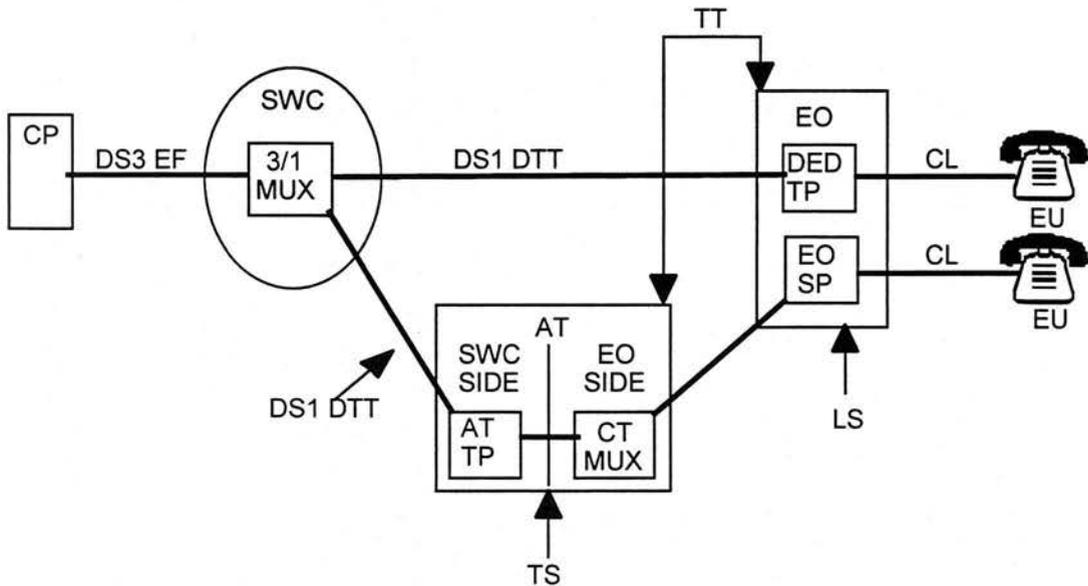

- AT - Access Tandem
- ATTP - Access Tandem Trunk Port
- CL - Common Line
- CP - Customer's Premises
- CT MUX - Common Transport Multiplexing
- DED TP - Dedicated Trunk Port
- DTT - Direct Trunked Transport
- EF - Entrance Facility
- EO - End Office
- EO SP - End Office Shared Port
- EU - End User
- LS - Local Switching
- MUX - EF Multiplexer
- SWC - Serving Wire Center
- TS - Tandem Switching
- TT - Tandem Transmission

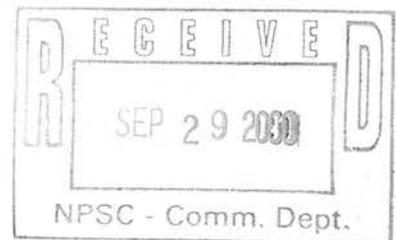

6. SWITCHED ACCESS SERVICE

6.1 GENERAL

6.1.2 RATE CATEGORIES (Cont'd)

EXAMPLE 4

Switched Access Service Ordered
with DS3 EF and DS3 TT Facility to an End Office

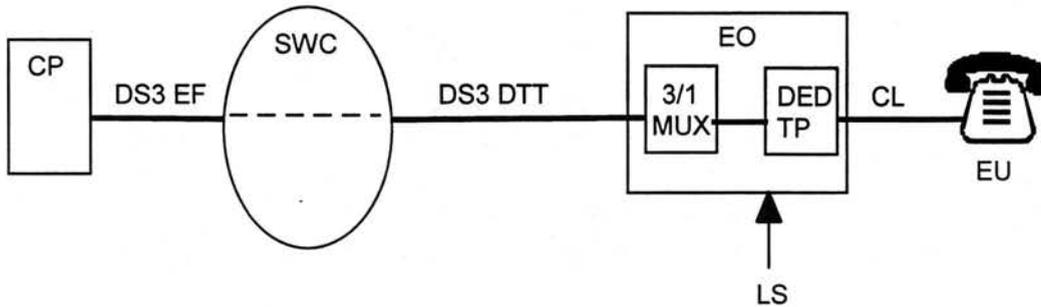

- CL - Common Line
- CP - Customer's Premises
- DED TP - Dedicated Trunk Port
- DTT - Direct Trunked Transport
- EF - Entrance Facility
- EO - End Office
- EU - End Users
- LS - Local Switching
- MUX - DTT Multiplexer
- SWC - Serving Wire Center

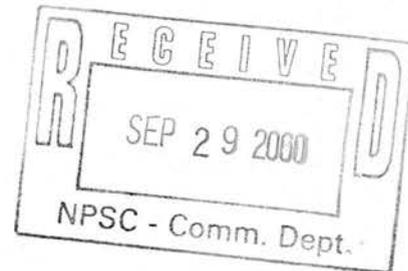

6. SWITCHED ACCESS SERVICE

6.1 GENERAL

6.1.2 RATE CATEGORIES (Cont'd)

EXAMPLE 5

Switched Access Service Ordered to a Company Hub

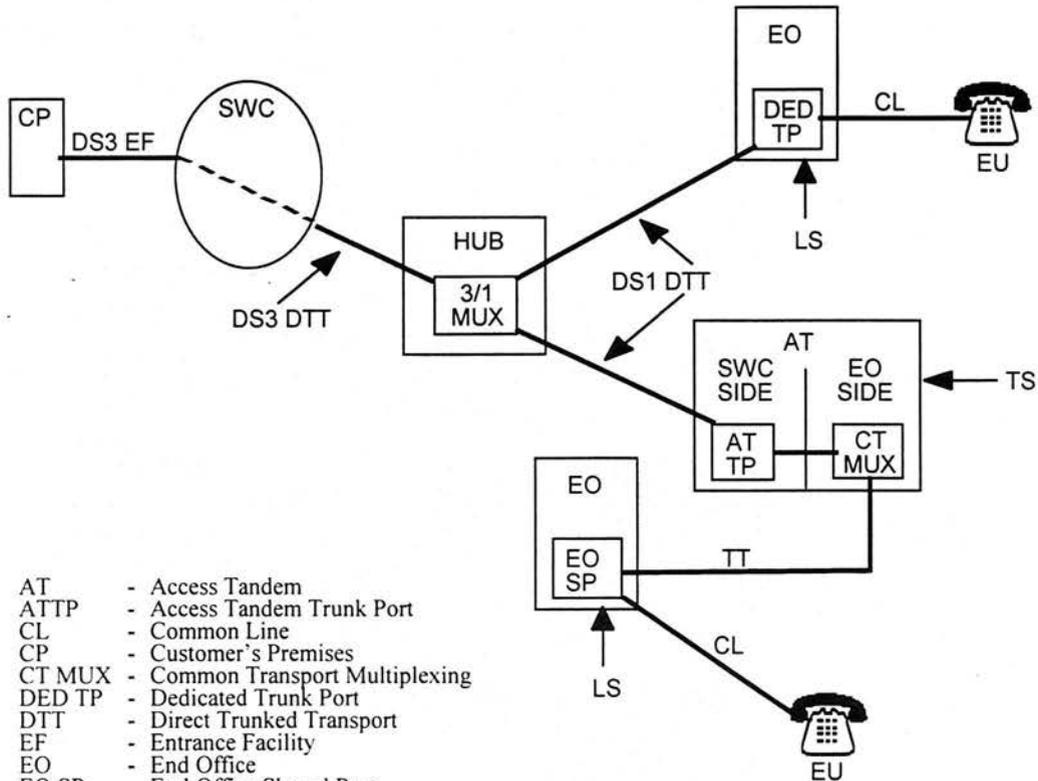

- AT - Access Tandem
- ATTP - Access Tandem Trunk Port
- CL - Common Line
- CP - Customer's Premises
- CT MUX - Common Transport Multiplexing
- DED TP - Dedicated Trunk Port
- DTT - Direct Trunked Transport
- EF - Entrance Facility
- EO - End Office
- EO SP - End Office Shared Port
- SWC - Serving Wire Center
- EU - End User
- HUB - HUB Location
- LS - Local Switching
- MUX - EF Multiplexer
- SWC - Serving Wire Center
- TS - Tandem Switching
- TT - Tandem Transmission

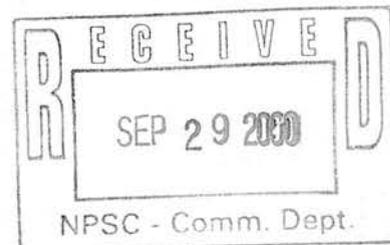

6. SWITCHED ACCESS SERVICE

6.1 GENERAL

6.1.2 RATE CATEGORIES (Cont'd)

EXAMPLE 6

Switched Access Service Connected
to Expanded Interconnection-Collocation

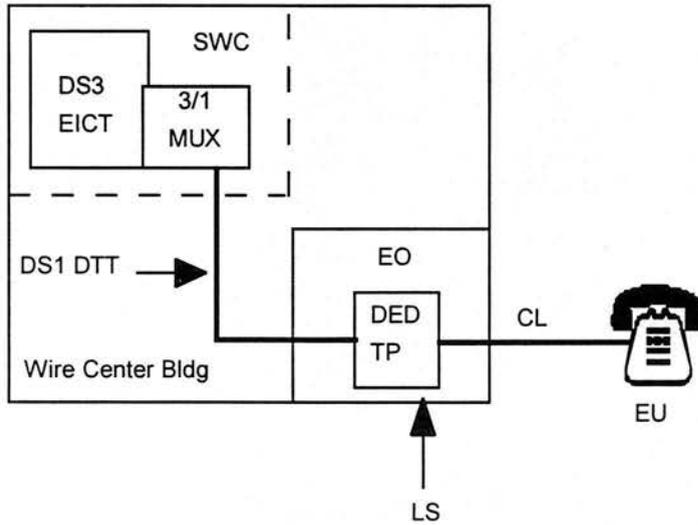

- CL - Common Line
- DED TP - Dedicated Trunk Port
- DTT - Direct Trunked Transport
- EICT - Expanded Interconnection-Collocation Channel Term
- EO - End Office
- EU - End User
- LS - Local Switching
- MUX - EF Multiplexer
- SWC - Serving Wire Center

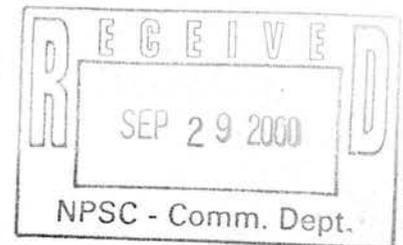

State of Nebraska
Notified: 9-29-2000

6. SWITCHED ACCESS SERVICE

6.1 GENERAL
6.1.2 RATE CATEGORIES (Cont'd)

EXAMPLE 7

Switched Access Service Connected
to Expanded Interconnection-Collocation

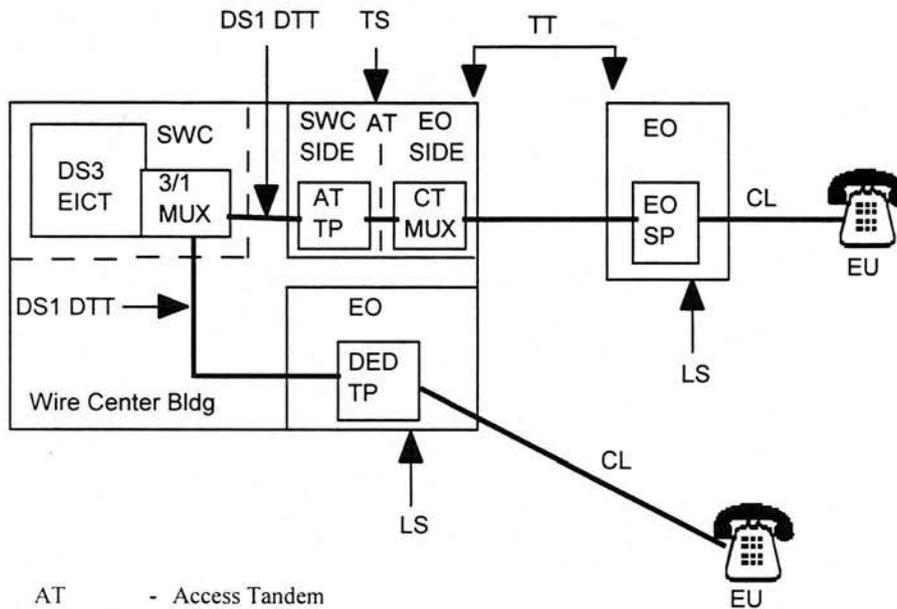

- AT - Access Tandem
- ATTP - Access Tandem Trunk Port
- CL - Common Line
- CT MUX - Common Transport Multiplexing
- DED TP - Dedicated Trunk Port
- DTT - Direct Trunked Transport
- EICT - Expanded Interconnection-Collocation Channel Term
- EO - End Office
- EO SP - End Office Shared Port
- EU - End User
- LS - Local Switching
- MUX - EF Multiplexer
- SWC - Serving Wire Center
- TS - Tandem Switching
- TT - Tandem Transmission

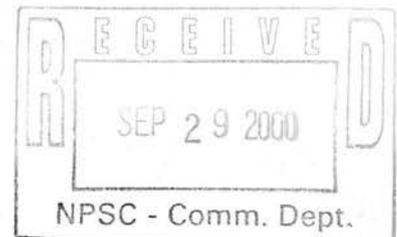

6. SWITCHED ACCESS SERVICE

6.1 GENERAL
6.1.2 RATE CATEGORIES (Cont'd)

EXAMPLE 8

**Private Line Service and Switched Access
 Ordered to a Company Hub**

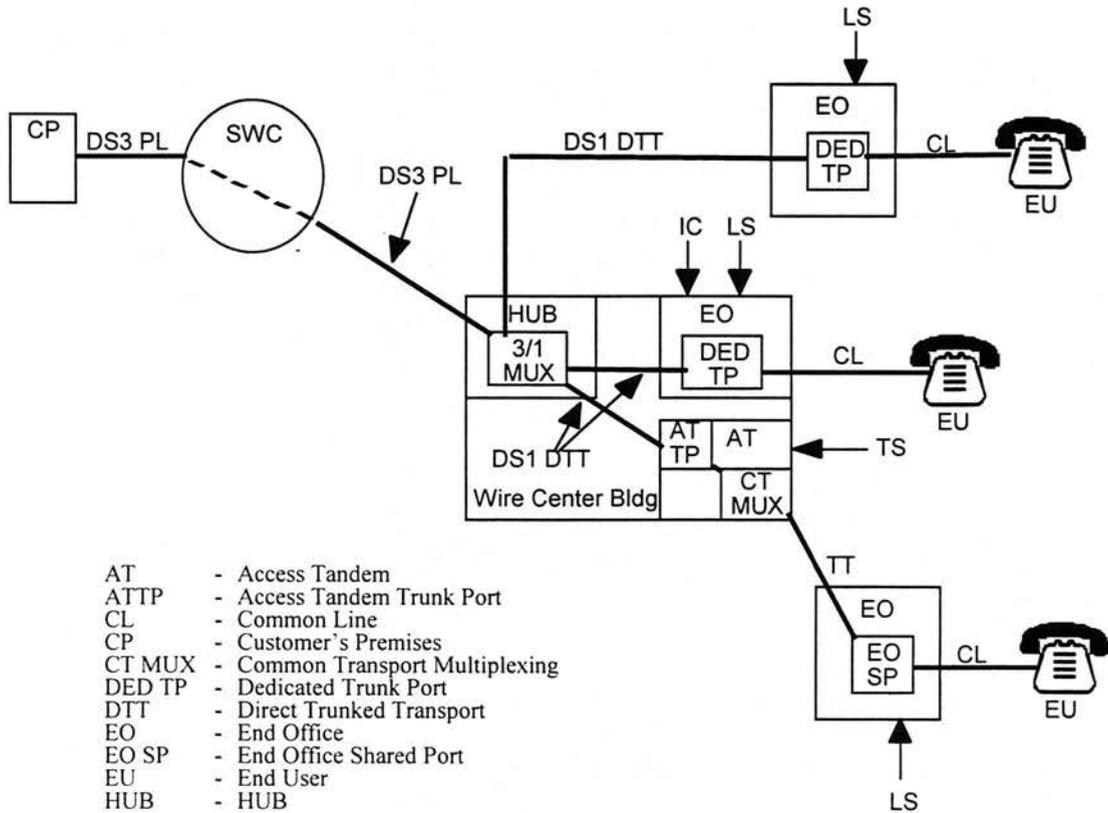

- AT - Access Tandem
- ATTP - Access Tandem Trunk Port
- CL - Common Line
- CP - Customer's Premises
- CT MUX - Common Transport Multiplexing
- DED TP - Dedicated Trunk Port
- DTT - Direct Trunked Transport
- EO - End Office
- EO SP - End Office Shared Port
- EU - End User
- HUB - HUB
- LS - Local Switching
- MUX - EF Multiplexer
- PL - Private Line
- SWC - Serving Wire Center
- TS - Tandem Switching
- TT - Tandem Transmission

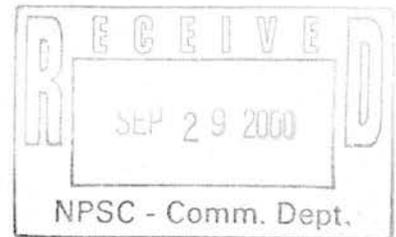

6. SWITCHED ACCESS SERVICE

6.1 GENERAL

6.1.2 RATE CATEGORIES (Cont'd)

A. Switched Transport

1. General Description

The Switched Transport rate category provides the transmission facilities between the customer's premises and the end office switch(es) where the customer's traffic is switched to originate or terminate its communications.

Switched Transport is a two-way voice-frequency transmission path composed of an Entrance Facility (EF) and a Direct-Trunked Transport (DTT) facility for direct routed traffic. For tandem routed traffic, the Switched Transport is composed of an EF, a DTT to an access tandem and Tandem-Switched Transport (TST) from the access tandem to the subtending end offices. The transmission path permits the transport of calls in the originating direction (from the end user's end office switch to the customer's premises) and in the terminating direction (from the customer's premises to the end office switch), but not simultaneously. The voice-frequency transmission path may be comprised of any form or configuration of plant capable of and typically used in the telecommunications industry for the transmission of voice and associated telephone signals within the frequency bandwidth of approximately 300 to 3000 Hz.

When a Switched Access Service connects to EI Service as set forth in Section 21, following, the Switched Access Service designated SWC and customer point of interconnection are defined in 6.1.1, preceding.

The Company will work cooperatively with the customer in determining (1) the EF, (2) whether the service is to be directly routed or routed through an access tandem switch, (3) the directionality of the service and (4) hubbing arrangements. Switched Transport optional features are provided as set forth in 4., following.

Switched Transport is provided at the rates and charges set forth in 6.8, following. The application of these rates with respect to the different types of service is as set forth in 6.7.1, following.

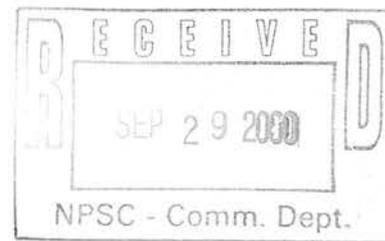

NOTICE

THE INFORMATION CONTAINED IN THIS DOCUMENT IS SUBJECT TO CHANGE.
NE2000-054

6. SWITCHED ACCESS SERVICE

6.1 GENERAL

6.1.2 RATE CATEGORIES

A.1. (Cont'd)

Switched Access is ordered under the access order provisions as set forth in Section 5, preceding. Design and traffic routing of Switched Access Service is described in 6.5.2, following.

Switched Transport is composed of an Entrance Facility (EF) rate category, as described in a., following, a Direct-Trunked Transport (DTT) rate category, as described in b., following and a Tandem-Switched Transport (TST) rate category, as described in c., following.

a. Switched Transport EF Rate Category

An EF provides the communication path between a customer's premises and the Company SWC of that premises for the sole use of the customer. The EF rate category is composed of a Voice Grade rate, a DS1 rate or a DS3 rate. An EF is provided even if the customer's premises and the SWC are located in the same building. The types of facilities available for Entrance Facilities are described in 2., following.

The EF rate category does not apply when Switched Access Service connects to EI Service as set forth in Section 21, following.



NOTICE

THE INFORMATION CONTAINED IN THIS DOCUMENT IS SUBJECT TO CHANGE.
NE2000-054

6. SWITCHED ACCESS SERVICE

6.1 GENERAL

6.1.2 RATE CATEGORIES

A.1. (Cont'd)

b. Switched Transport DTT Rate Category

DTT provides the transmission path on circuits dedicated to the use of a single customer between:

- the customer's SWC and an end office, or
- the customer's SWC and an access tandem, or
- the customer's SWC and a Company Hub where multiplexing functions are performed, or
- a Company Hub and an end office, or
- a Company Hub and an access tandem.

The DTT rate category is composed of a monthly fixed rate and a monthly per-mile rate based on the facility provided, (i.e., Voice Grade, DS1 or DS3). The fixed rate provides the circuit equipment at the ends of the transmission paths. The per-mile rate provides the transmission facilities, including intermediate transmission circuit equipment, between the end points of the circuit. The DTT rate is the sum of the fixed rate and the per-mile rate. For purposes of determining the per-mile rate, mileage will be measured as airline mileage using the V & H coordinates method. Mileage measurement rules are set forth in 6.7.11, following. The types of facilities available for DTT are described in 2., following.

c. Switched Transport TST Rate Category

TST provides the transmission facilities between an access tandem and end offices subtending that tandem utilizing tandem switching functions. TST is not available from or to a Company Hub. TST consists of circuits used in common by multiple customers from the access tandem to an end office. For TST, the Company will determine the type of facilities to the end office(s) based on the customer's order for service on a per-trunk basis. For examples of Tandem Switched Transport see Section 2.4.7 preceding.

(M)
(M)

(M) Material moved to Page 14.1 of this section.

Qwest Corporation d/b/a CenturyLink QC

Access Service
Catalog

SECTION 6

Page 14.1

Release 1

State of Nebraska

Notified: 06-18-2021

Effective: 07-01-2021

6. SWITCHED ACCESS SERVICE

6.1 GENERAL

6.1.2 RATE CATEGORIES

A.1. (Cont'd)

c. Switched Transport TST Rate Category (Cont'd)

Effective July 1, 2021, as established in the 8YY Access Charge Reform (FCC 20-143), existing tandem switching charges and transport charges for originating 8YY traffic are eliminated and a single joint tandem switched access service rate element for 8YY originating access service is established. The 8YY originating Joint Tandem Switched Transport rate is provided at the rates set forth in Section 6.8.1 C.1.d.

(N)

(N)

The TST rate category is composed of the rate elements set forth in (1) through (4), following. Rates and charges are set forth in 6.8, following.

(M)

(M)

(M) Material moved from Page 14 of this section.

NE 2021-09

6. SWITCHED ACCESS SERVICE

6.1 GENERAL

6.1.2 RATE CATEGORIES

A.1.c. (Cont'd)

(1) Tandem Transmission

Tandem Transmission is composed of a fixed per-MOU rate and per-mile/per-MOU rate. The fixed rate provides for the circuit equipment at the end of the interoffice transmission paths. The per-mile rate provides for the transmission facilities, including intermediate transmission circuit equipment between the end points of the interoffice circuit. For purposes of determining the per-mile rate, mileage will be measured as airline mileage using the V & H coordinates method. Mileage measurement rules are set forth in 6.7.11, following.

(2) Tandem Switching

Tandem Switching is a per-MOU rate assessed for utilizing tandem switching functions when tandem routing is requested for trunkside services. Tandem Switching is not assessed to FGA services.

(3) Access Tandem Trunk Port

An access tandem trunk port (ATTP) is provided for each trunk terminated on the SWC side of the access tandem when the customer has requested tandem routing. The ATTP rate is assessed monthly per Feature Group trunk (excludes FGA).

(4) Common Transport Multiplexing

Common transport multiplexing equipment is utilized in the end office side of the access tandem when common transport is provided between the access tandem and the subtending end offices. This rate is assessed on a per-MOU basis. (Multiplexing equipment associated with a DTT facility ordered to the access tandem is provisioned on the SWC side of the access tandem. Multiplexing rates for EF and DTT facilities are described in 4., following, and if assessed, are in addition to the common transport multiplexing rates.)

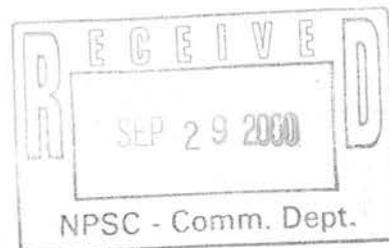

NOTICE

THE INFORMATION CONTAINED IN THIS DOCUMENT IS SUBJECT TO CHANGE.
NE2000-054

6. SWITCHED ACCESS SERVICE

6.1 GENERAL

6.1.2 RATE CATEGORIES

A. Switched Transport (Cont'd)

2. Switched Transport Facilities

Customers requesting Lineside or Trunkside Switched Access service shall specify the type of Entrance Facility (Voice Grade, DS1 or DS3) between the customer's premises and the SWC. The customer shall also specify if tandem routing or direct routing will be utilized for trunkside services. If tandem routing is desired, the customer must specify the type of DTT facility (Voice Grade, DS1 or DS3) to be utilized from the SWC to the access tandem and the Company will determine the type of facilities (i.e., common transport) to the subtending end offices. Tandem routing is not available for Lineside Switched Access Service. If direct routing is requested, the customer shall specify the type of DTT facility (Voice Grade, DS1 or DS3) to be utilized from the SWC to the end office.

There are three types of facilities, Voice Grade, DS1 or DS3, available to the customer for Entrance Facilities and DTT facilities for Lineside or Trunkside Switched Access Service. Following is a brief description of each type of facility. Each type has its own characteristics and is available with EF and DTT multiplexing options as set forth in 4., following.

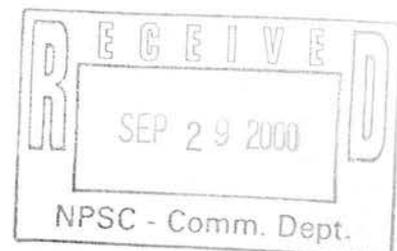

NOTICE

THE INFORMATION CONTAINED IN THIS DOCUMENT IS SUBJECT TO CHANGE.
NE2000-054

6. SWITCHED ACCESS SERVICE

6.1 GENERAL

6.1.2 RATE CATEGORIES

A.2. (Cont'd)

a. Voice Grade Facility

Voice Grade facilities are available for Entrance Facilities and for DTT facilities. A Voice Grade facility is an electrical communications path which provides voice-frequency transmission in the nominal frequency range of 300 to 3000 Hz and may be terminated two-wire or four-wire. Compatible Interface Groups are described in 3., following.

b. DS1 Facility

DS1 facilities are available for Entrance Facilities and for DTT facilities. A DS1 facility is capable of transmitting electrical signals at a nominal 1.544 Mbps, with the capability to channelize up to 24 voice-frequency transmission paths. Compatible Interface Groups are described in 3., following.

c. DS3 Facility

DS3 facilities are available for Entrance Facilities and DTT facilities. A DS3 facility is capable of transmitting electrical signals at a nominal 44.736 Mbps, with the capability to channelize up to 672 voice-frequency transmission paths. Compatible Interface Groups are described in 3., following.

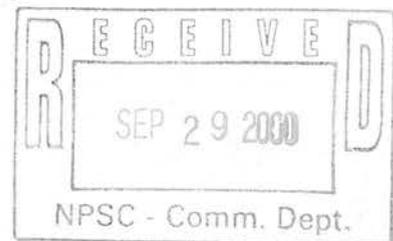

6. SWITCHED ACCESS SERVICE

6.1 GENERAL
6.1.2 RATE CATEGORIES

A.2. (Cont'd)

d. Hubbing

Hubbing arrangements requested from the SWC to a hub location, or from one hub location to a different hub location, shall be ordered out of this section as DTT for Switched Access only. Hubbing arrangements ordered from Section 7 of the Interstate Access Service Tariff F.C.C. No. 1, for the provision of Shared Use services can be utilized for both PLTS and Switched Access Service.

When the SWC is in the same wire center building as an end office, access tandem and/or hub, the customer must order DTT from the SWC as set forth in 1. and 2., preceding. A multiplexing function performed in the SWC for an EF is not a hubbing arrangement.

A hub is a Company designated wire center, other than the SWC, at which multiplexing functions are performed. Hubbing allows the customer to terminate a DTT facility to a hub so that the facility can be de-multiplexed to a lower capacity and the lower capacity DTT facility is then routed to an access tandem, end office or another hub. When the customer requests DTT from the SWC to a hub and facilities from the hub to an access tandem, the customer must order DTT from the hub to the access tandem and TST from the access tandem to end offices subtending that tandem.

Multiplexing functions for EF and DTT facilities are described in 4., following. Hub locations and the types of multiplexing available at each location for DS1 facilities are specified in the NECA Tariff F.C.C. No. 4. For DS3 facilities, the Company will work cooperatively with the customer to provide the desired hubbing arrangements.

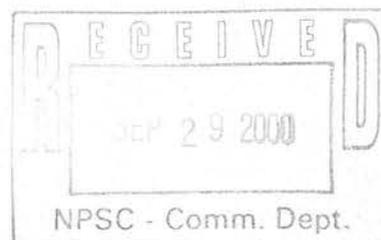

NOTICE

6. SWITCHED ACCESS SERVICE

6.1 GENERAL

6.1.2 RATE CATEGORIES

A. Switched Transport (Cont'd)

3. Interface Groups

Four Interface Groups are provided for terminating the Switched Transport at the customer's premises. Each Interface Group provides a specified premises interface (e.g., two-wire, four-wire, DS1, etc.). Where transmission facilities permit, the individual transmission path between the customer's premises and the first point of switching may, at the option of the customer, be provided with optional features as set forth in 4., following.

As a result of the customer's access order and the type of Company transport facilities serving the customer's premises, the need for signaling conversions or two-wire to four-wire conversions, or the need to terminate digital or high frequency facilities in channel bank equipment, may require that Company equipment be placed at the customer's premises. For example, if a voice frequency interface is ordered by the customer and the Company facilities serving the customer's premises are digital, then Company channel bank equipment must be placed at the customer's premises in order to provide the voice frequency interface ordered by the customer.

Interface Group Transmission Specifications and Data Transmission Parameters are delineated in Technical Reference GR-334-CORE.

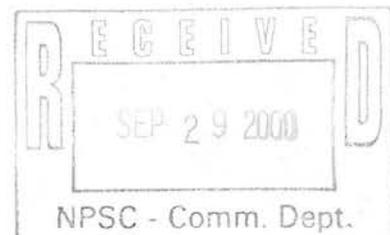

NOTICE

THE INFORMATION CONTAINED IN THIS DOCUMENT IS SUBJECT TO CHANGE.
NE2000-054

6. SWITCHED ACCESS SERVICE

6.1 GENERAL

6.1.2 RATE CATEGORIES

A.3. (Cont'd)

Only certain Network Channel Interface codes (NCI) are available at the customer's premises. The NCI codes associated with the Interface Groups may vary among different types of service based on the technical requirements. The various premises interfaces which are available with the Interface Groups, and the types of service with which they may be used, are set forth in e., following.

Based upon the Interface Group chosen by the customer, EF and DTT multiplexing arrangements may be required. Multiplexing arrangements are described in 4., following.

When Switched Access Services are ordered in conjunction with Private Line Transport DS3 Service which is provisioned with an Electrical capacity of two or greater or any Optical Interface ordered and provided from Section 7 of the Interstate Access Service Tariff F.C.C. No. 1, the common interface will be provisioned under the rules and regulations for Shared Use between Private Line Transport and Switched Access Services referenced in 2.7, preceding. The rate for DS3 EF Electrical capacity of two or greater or any Optical Interface is for the billing of Shared Use only. Switched Access Services rates and charges as set forth in 6.8, following will apply for each channel of the Shared Use facility that is used to provide Switched Access Service. Technical specifications are delineated in Qwest Corporation Technical Reference 77324.

When Interface Groups 1, 2, 6 or 9 are associated with FGD Service with SS7 out of band signaling, no signaling will be done via the message channel.

When *SWITCHNET 56* Service is ordered in conjunction with FGD, it requires the use of a separate trunk group equipped with Interface Group 6. This service allows a customer to establish a connection between the customer's premises and a suitably equipped end user premises over facilities capable of transmitting digital data at 56 kbps.

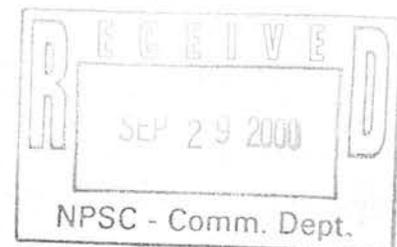

6. SWITCHED ACCESS SERVICE

6.1 GENERAL

6.1.2 RATE CATEGORIES

A.3. (Cont'd)

a. Interface Group 1

Interface Group 1, except as set forth in the following, provides two-wire voice frequency transmission at the customer's premises.

Interface Group 1 is not provided in association with Trunkside Access when the first point of switching is an access tandem. In addition, Interface Group 1 is not provided in association with Trunkside Access when the first point of switching provides only four-wire terminations.

b. Interface Group 2

Interface Group 2 provides four-wire voice frequency transmission at the customer's premises.

c. Interface Group 6

Interface Group 6 provides DS1 level digital transmission at the customer's premises.

d. Interface Group 9

Interface Group 9 provides DS3 level digital transmission at the customer's premises.

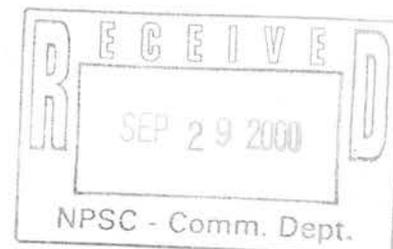

6. SWITCHED ACCESS SERVICE

6.1 GENERAL

6.1.2 RATE CATEGORIES

A.3. (Cont'd)

e. Available Premises Interface Codes

The following matrix lists the NC1 codes available for each Interface Group with additional information defining the availability of each offering. The provision of some NC1 codes generally requires placement of Company equipment at the customer's premises. These codes are denoted with a footnote designator[1].

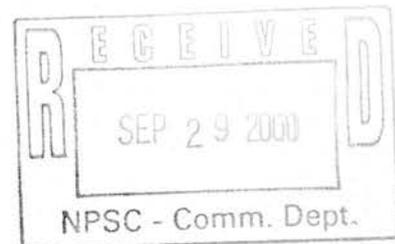

Qwest Corporation
Access Service
Catalog

SECTION 6

Page 23

Release 1

State of Nebraska
 Notified: 9-29-2000

Effective: 9-29-2000

6. SWITCHED ACCESS SERVICE

6.1 GENERAL
6.1.2 RATE CATEGORIES
 A.3.e. (Cont'd)

INTERFACE GROUP	COMPANY SWITCH SUPERVISORY	NCI CODE	SWITCHED ACCESS SERVICE FEATURE GROUP			
			A	B	C	D
1	LO	2LS2	X			
	LO	2LS3	X			
	GO	2GS2	X			
	GO	2GS3	X			
	RV, EA, EB, EC	4EA3-E[1]		X	X	X
	RV, EA, EB, EC	4EA3-M[1]		X	X	X
	RV, EA, EB, EC	6EB3-E[1]		X	X	X
	RV, EA, EB, EC	6EB3-M[1]		X	X	X
	RV	2RV3-0		X	X	X
	RV	2RV3-T		X	X	X
	CCS	2N02				X

[1] Company equipment is generally required at the customer's premises.

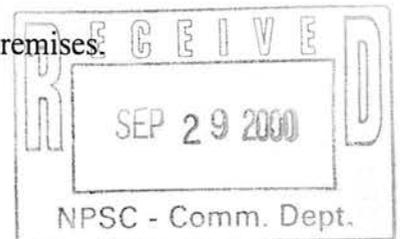

NOTICE
 THE INFORMATION CONTAINED IN THIS DOCUMENT IS SUBJECT TO CHANGE.

Qwest Corporation
Access Service
Catalog

SECTION 6
 Page 24
 Release 1
 Effective: 9-29-2000

State of Nebraska
 Notified: 9-29-2000

6. SWITCHED ACCESS SERVICE

6.1 GENERAL
6.1.2 RATE CATEGORIES
 A.3.e. (Cont'd)

INTERFACE GROUP	COMPANY SWITCH SUPERVISORY	NCI CODE	SWITCHED ACCESS SERVICE FEATURE GROUP			
			A	B	C	D
2	LO, GO	4SF2	X			
	LO	4LS2	X			
	GO	4GS2	X			
	RV, EA, EB, EC	4SF2		X	X	X
	RV, EA, EB, EC	6EA2-E[1]		X	X	X
	RV, EA, EB, EC	6EA2-M[1]		X	X	X
	RV, EA, EB, EC	8EB2-E[1]		X	X	X
	RV, EA, EB, EC	8EB2-M[1]		X	X	X
	EA, EB, EC	8EC2-M[1]		X	X	X
	RV	4RV2-0		X	X	X
	RV	4V2-T				
	CCS	4N02				X

[1] Company equipment is generally required at the customer's premises.

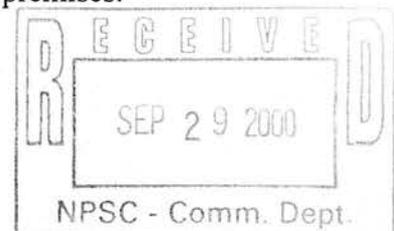

Qwest Corporation
Access Service
Catalog

SECTION 6
Page 25
Release 1

State of Nebraska
Notified: 9-29-2000

Effective: 9-29-2000

6. SWITCHED ACCESS SERVICE

6.1 GENERAL
6.1.2 RATE CATEGORIES
A.3.e. (Cont'd)

INTERFACE GROUP	COMPANY SWITCH SUPERVISORY	NCI CODE	SWITCHED ACCESS SERVICE FEATURE GROUP			
			A	B	C	D
6	LO, GO	4DS9-15[1]	X			
	LO, GO	4DS9-15L[1]	X			
	LO, GO	4DS9-15S[1]	X			
	RV, EA, EB, EC	4DS9-15[1]		X	X	X
	RV, EA, EB, EC	4DS9-15L[1]		X	X	X
	RV, EA, EB, EC	4DS9-15S[1]		X	X	X
	CCS	4DS9-15				X
	CCS	4DS9-15B[2]				X
	CCS	4DS9-15S[2]				X
9	LO, GO	4DS6-44[1]	X			
	LO, GO	2FCF-[3]	X	X	X	X
	RV, EA, EB, EC	4DS6-44		X	X	X
	RV, EA, EB, EC	2FCF-[3]	X	X	X	X
	CCS	4DS6-44				X
	CCS	2FCF-[3]				X

- [1] Company equipment is generally required at the customer's premises.
- [2] Required with Clear Channel Capability.
- [3] Available when Switched Access Services are ordered in conjunction with DS3 optical.

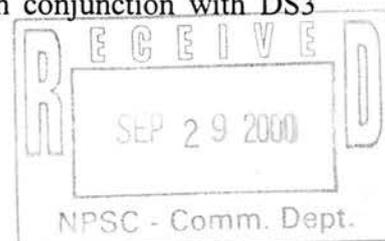

NOTICE
THE INFORMATION CONTAINED IN THIS DOCUMENT IS SUBJECT TO CHANGE.

Qwest Corporation
Access Service
Catalog

SECTION 6
Page 26
Release 1
Effective: 9-29-2000

State of Nebraska
Notified: 9-29-2000

6. SWITCHED ACCESS SERVICE

6.1 GENERAL

6.1.2 RATE CATEGORIES

A. Switched Transport (Cont'd)

4. Optional Features

Where transmission facilities permit, the Company will, at the option of the customer, provide the following Switched Transport optional features at the rates and charges as set forth in 6.8, following.

a. POT Supervisory Signaling Arrangements

Where the transmission parameters permit, and where signaling conversion is required by the customer to meet its signaling capability, the customer may order a POT optional supervisory signaling arrangement for each transmission path. Available supervisory signaling arrangements for Lineside and Trunkside terminations are set forth in 3., preceding. Technical specifications for supervisory signaling are delineated in Technical Reference GR-334-CORE.

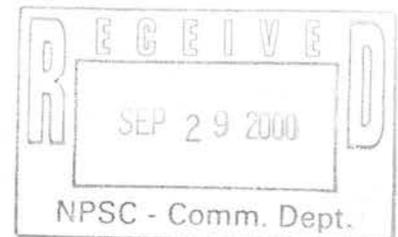

6. SWITCHED ACCESS SERVICE

6.1 GENERAL

6.1.2 RATE CATEGORIES

A.4. (Cont'd)

b. Customer Specified Entry Switch Receive Level

This feature allows the customer to specify the receive transmission level at the first point of switching. The range of transmission levels which may be specified is described in Technical Reference GR-334-CORE. This feature is available with Interface Groups 2, 6 and 9 for Feature Groups A and B.

c. Customer Specification of Switched Transport Termination

This option allows the customer to specify, for Feature Group B routed directly to an end office or an access tandem, a four-wire termination of the Switched Transport at the entry switch in lieu of a Company selected two-wire termination. This option is available only when the Feature Group B arrangement is provided with Transmission Type B1 performance.

d. Multiple POTs Tandem Sectorization

Multiple POTs Tandem Sectorization (MPTS) is an optional feature designed to meet the traffic routing requirements of customers whose Feature Group C or D originating Switched Access Services are routed through an access tandem from multiple customer points of termination (POTs).

MPTS is available in connection with originating Feature Group C and D Services. MPTS allows originating Feature Group C and D traffic to be directed via an access tandem to a specific POT designated by the customer. MPTS permits customers with multiple POTs within a tandem serving area to balance the call volume within their respective networks. MPTS may be used in conjunction with the Common Switching Optional Feature Service Class Routing (e.g., 8XX, 900, Operator), as specified in 6.3.1, following, with the exception of *SWITCHNET 56* Service.

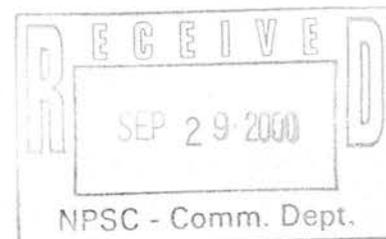

6. SWITCHED ACCESS SERVICE

6.1 GENERAL

6.1.2 RATE CATEGORIES

A.4.d. (Cont'd)

End offices subtending the tandem serving area will be divided into sectors, referred to as Feature Group C and D Tandem Sectors, which will be defined by the Company. Each Tandem Sector must be treated as a unit and cannot be subdivided. Tandem Sectors are standard for all customers who purchase MPTS. MPTS must be ordered to every sector of an access tandem. A customer with multiple POTs within the tandem serving area can designate to which POT the traffic from a specific tandem sector will be routed. For example, a customer with multiple POTs can request that all originating calls from a tandem sector be directed to a single POT. In addition, originating traffic from a different tandem sector could be routed to the same POT or a different POT as designated by the customer.

Tandem routed traffic can be delivered to a minimum number of two POTs and a maximum number of POTs that is less than or equal to the number of tandem sectors defined for a particular tandem. The end offices associated with the tandem sectors can be found in the Qwest Corporation Tandem Sectorization Guide.

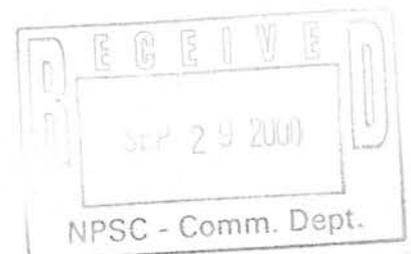

6. SWITCHED ACCESS SERVICE

6.1 GENERAL

6.1.2 RATE CATEGORIES

A.4.d. (Cont'd)

The Company shall not be required to route traffic from a tandem sector to more than one POT unless the customer has the optional feature, Service Class Routing as described in 6.3.1.L., following, in addition to MPTS. Tandem routed traffic with Service Class Routing can be delivered by traffic type to a minimum number of one POT and a maximum number of POTs that is less than or equal to the number of tandem sectors defined for a particular tandem. A maximum number of four (4) trunk groups with mixed traffic types in accordance with the Service Class Routing specifications is allowed for each designated tandem sector. Each traffic type (e.g., 8XX 900, MTS) within a tandem sector can be designated to the same POT or different POTs. A customer with multiple POTs must direct all originating calls from a Tandem Sector to a single POT by traffic type.

MPTS in conjunction with Service Class Routing - A customer may designate one to four POTs per traffic type. For example, when MPTS is ordered for a specific tandem, it is possible to route all of a particular traffic type (e.g., 8XX or Operator) to only one POT subtending that tandem, as long as other traffic type(s) comply to the stated MPTS guidelines of directing traffic to multiple POTs within a tandem serving area.

MPTS in conjunction with Alternate Traffic Routing - If a customer wants a direct trunk group from an end office to alternate route to a tandem routed trunk group subtending the same end office, the customer can designate the direct routed traffic sent to any POT, but the tandem routed trunk group must be routed to the customer designated POT that is specified for the tandem sector as referred to in 6.3.1.M., following.

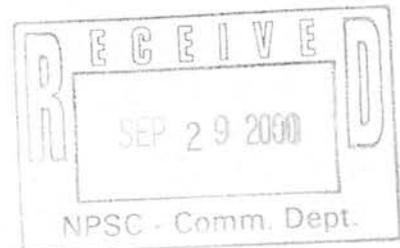

6. SWITCHED ACCESS SERVICE

6.1 GENERAL
6.1.2 RATE CATEGORIES
A.4. (Cont'd)

e. Multiplexing for EF and DTT Facilities

Multiplexing provides the capability of converting the capacity or bandwidth of a facility from a higher level to a lower level or from a lower level to a higher level. Multiplexing functions for an EF are available at a SWC. For DTT facilities, multiplexing is available at a Company Hub, end office or access tandem. Multiplexing arrangements are associated with the facility with the higher capacity or bandwidth (e.g., a DS1 to Voice Grade multiplexing arrangement is associated with the facility using a DS1 connection). (Common transport multiplexing, as described in 1., preceding, is provided on the end office side of the access tandem when tandem routing is requested.)

EF and DTT multiplexing arrangements may be connected to an Expanded Interconnection Channel Termination as set forth in Section 21, following.

EF and DTT multiplexing arrangements are described following.

DS1 to Voice Grade

DS1 to Voice Grade multiplexing is an arrangement that provides a Company multiplexer which converts a DS1 channel to twenty-four Voice Grade channels utilizing time division multiplexing. For example, the customer has the option of ordering a DS1 to Voice Grade multiplexer for a DS1 Entrance Facility at the SWC when Voice Grade DTT is requested to an end office.

DS3 to DS1

DS3 to DS1 multiplexing is an arrangement which converts a DS3 channel to twenty-eight DS1 channels utilizing time division multiplexing. The twenty-eight channels may be further multiplexed utilizing DS1 to Voice Grade multiplexing equipment.

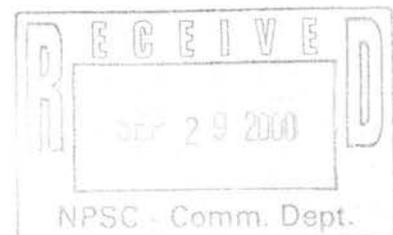

6. SWITCHED ACCESS SERVICE

6.1 GENERAL

6.1.2 RATE CATEGORIES

A.4.e. (Cont'd)

EF and DTT multiplexing equipment is provided at no charge by the Company (at a location determined by the Company as part of its overall network design) when the following conditions exist:

- a DTT at a DS1 level is requested from a SWC to an access tandem in conjunction with TST from an access tandem to subtending end offices, or
- a DS1 DTT facility terminates in an end office except when Lineside and Trunkside Access are combined on the same facility.

If the customer chooses to order multiplexing equipment at a location other than the location determined by the Company, the customer will be assessed EF and DTT multiplexing rates and charges as set forth in 6.8, following.

EF and DTT multiplexing arrangements are required and the customer will be assessed multiplexing rates and charges as set forth in 6.8, following, when the following conditions exist:

- a DS3 EF facility is requested, or
- a DS3 EF connects to a DS1 DTT facility, or
- A DS3 EF is requested with a DS3/DS1 multiplexer and a DS1/DS0 multiplexer for connection to a Voice Grade DTT facility, or
- a DS1 EF connects to a Voice Grade DTT facility, or
- a higher capacity DTT facility connects to a lower capacity DTT facility at a Company Hub, or
- a DS1 DTT facility transports a combination of Lineside and Trunkside Access to an end office on the same facility, or
- Shared Use facilities are requested.

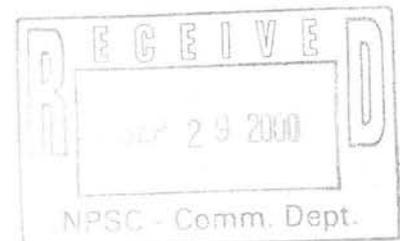

6. SWITCHED ACCESS SERVICE

6.1 GENERAL

6.1.2 RATE CATEGORIES (Cont'd)

B. Local Switching

The Local Switching rate category provides the local end office switching, end user line termination and intercept functions necessary to complete the transmission of Switched Access Communications to and from the end users served by the local end office. The Local Switching rate category includes the Local Switching and Information (i.e., Voice DA) rate elements. Voice DA Service and the applicable rates for it are set forth in Section 9, following.

The Local Switching rate element provides local dial switching for Feature Groups A, B, C and D.

Local Switching rates are set forth in 6.8, following. The application of these rates with respect to the different types of service is as set forth in 6.7.1, following.

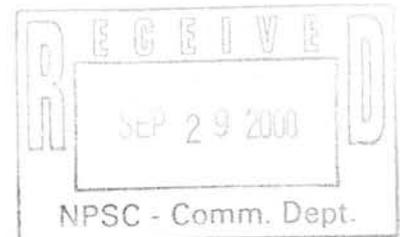

6. SWITCHED ACCESS SERVICE

6.1 GENERAL

6.1.2 RATE CATEGORIES

B. Local Switching (Cont'd)

1. Local End Office Switching Functions

a. Common Switching

Common Switching provides the local end office switching functions associated with the various access switching arrangements. The Common Switching arrangements provided for the various types of service arrangements are described in 6.2, following.

Included as part of Common Switching are various optional features which the customer can order to meet its specific communications requirements. These optional features are described in 6.3.1, following.

b. Transport Termination

Transport Termination provides for the lineside or trunkside arrangements which terminate the Switched Transport facilities. Included as part of Transport Termination are various optional termination arrangements. These optional terminating arrangements are described in 6.3.2, following.

The number of Transport Terminations provided for the lineside or trunkside arrangement will be determined by the Company as set forth in 6.5.8, following.

2. Line Termination Functions

Common Line Terminations and WATS Access Line Terminations are provided for end user lines terminating in the local end office.

The WATS Access Line Terminations are differentiated by line vs. trunkside terminations. In addition, there are various types of originating and terminating lineside terminations depending on the type of signaling associated with the WATS Access Line. Lineside terminations are available with either dial-pulse or dual-tone multifrequency address signaling.

3. Intercept Function

The Intercept function provides for the termination of a call at a Company Intercept operator or recording. The operator or recording tells a caller why a call, as dialed, could not be completed, and if possible, provides the correct number.

The number of transmission paths will be determined as set forth in 6.5.7, following.

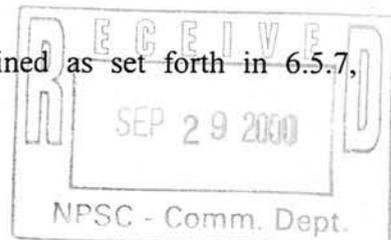

NOTICE

THE INFORMATION CONTAINED IN THIS DOCUMENT IS SUBJECT TO CHANGE.

6. SWITCHED ACCESS SERVICE

6.1 GENERAL

6.1.2 RATE CATEGORIES

B. Local Switching (Cont'd)

4. Local Switching Rate Categories

a. End Office Shared Port

The End Office Shared Port rate provides for the termination of common transport trunks in shared end office ports and in remote switching system or module (RSS or RSM) ports. The End Office Shared Port rate is assessed on a per-MOU basis to all trunkside originating and terminating access minutes utilizing tandem routing to an end office. If tandem routing is being utilized to a RSS or RSM (via a host office), the shared port rate is assessed to the access minutes originating or terminating from that RSS or RSM and is not assessed at the host office. If the customer has requested direct routing from the SWC to a RSS or RSM (via a host office), the End Office Shared Port rate is assessed to the access minutes originating or terminating from the RSS or RSM. This rate is in addition to the End Office Dedicated Trunk Port rate assessed for the dedicated trunk terminating in the host office as described below. The port charge is not assessed to FGA or DA traffic.

b. End Office Dedicated Trunk Port

The End Office Dedicated Trunk Port rate provides for termination of a trunk to a dedicated trunk port in an end office. The rate is assessed per month for each FG trunk in service (excludes FGA) directly routed (via DTT) between the SWC and the end office. The rate is not assessed to trunks directly routed to a DA location.

6.1.3 SPECIAL FACILITIES ROUTING

Any customer may request that the facilities used to provide Switched Access Service be specially routed. The regulations, rates and charges for Special Facilities Routing (i.e., Avoidance, Diversity and Cable Only) are as set forth in Section 11, following.

6.1.4 DESIGN LAYOUT REPORT

The Company will provide to the customer the makeup of the facilities and services provided from the customer's premises to the first point of switching or from the customer's point of interconnection to the first point of switching when Switched Access Service connects to EI Service, as set forth in Section 21, following. This information will be provided in the form of a Design Layout Report. The Design Layout Report will be provided to the customer at no charge, and will be reissued or updated whenever these facilities are materially changed.

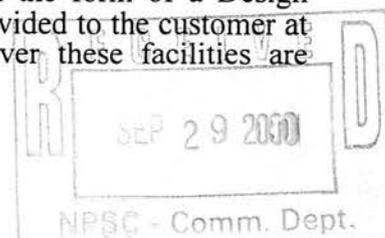

NOTICE

THE INFORMATION CONTAINED IN THIS DOCUMENT IS SUBJECT TO CHANGE.

6. SWITCHED ACCESS SERVICE

6.1 GENERAL (Cont'd)

6.1.5 ACCEPTANCE TESTING

At no additional charge, the Company will perform acceptance testing at the time of installation. Acceptance tests will be performed to insure that the service is operational and meets applicable technical parameters. The Company will, at the customer's request, schedule a mutually agreeable time to perform acceptance testing in cooperation with the customer. If the customer is unable to participate in the acceptance testing, or if the customer requests that service installation be completed without their presence, the service is assumed to be accepted (i.e., blind acceptance) by the customer.

6.1.6 ORDERING OPTIONS AND CONDITIONS

Switched Access Service is ordered under the Access Order provisions set forth in Section 5, preceding. Also included in that section are other charges which may be associated with ordering Switched Access Service (e.g., Cancellation Charges, etc.).

6.1.7 SPECIAL HIGH VOLTAGE PROTECTIVE APPARATUS

If Switched Access Service terminates in a high voltage environment, such as an electric power station, Special High Voltage Protective Apparatus may be required as set forth in 13.3.7, following.

6.2 PROVISION AND DESCRIPTION OF SWITCHED ACCESS SERVICE

Switched Access Service is provided in different serving arrangements. The provision of each type of Switched Access Service requires Switched Transport facilities (Entrance facilities, DTT facilities and TST facilities for tandem routed traffic), multiplexing equipment and the appropriate local switching functions.

Transmission types (i.e., A1, B, B1 and C) have been identified for the provision of Switched Access Services. The Transmission Types are dependent on the Interface Group and the routing of the service, i.e., whether the service is routed directly to the end office or via an access tandem. The standard parameter limits for the Transmission types are set forth in Technical Reference GR-334-CORE.

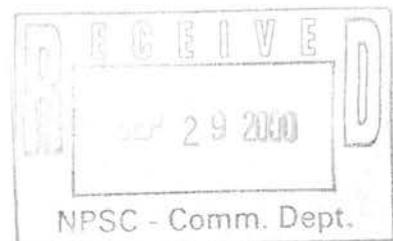

6. SWITCHED ACCESS SERVICE

6.2 PROVISION AND DESCRIPTION OF SWITCHED ACCESS SERVICE (Cont'd)

Serving arrangements are arranged for either originating, terminating or two-way calling, based on the customer end office switching capacity ordered. Originating calling permits the delivery of calls from Telephone Exchange Service locations to the customer's premises. Terminating calling permits the delivery of calls from the customer's premises to Telephone Exchange Service locations. Two-way calling permits the delivery of calls in both directions, but not simultaneously. The Company will determine the type of calling to be provided unless the customer requests that a different type of directional calling is to be provided. In such cases, the Company will work cooperatively with the customer to determine the directionality.

There are various optional features available with Switched Access Service. These additional features are provided as Switched Transport, Common Switching, Transport Termination and Line Termination.

Following are detailed descriptions of each of the available Switched Access Services. Each service is described in terms of its specific physical characteristics and calling patterns, the transport provisioning, the transmission specifications with which it is provided, the optional features available for use with it and the standard testing capabilities.

The Common Switching, Transport Termination, and Line Termination optional features, which are described in 6.3, following, unless specifically stated otherwise, are available at all Company end office switches.

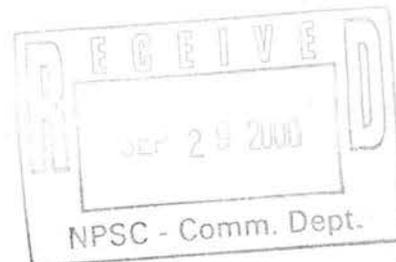

6. SWITCHED ACCESS SERVICE

6.2 PROVISION AND DESCRIPTION OF SWITCHED ACCESS SERVICE (Cont'd)

6.2.1 FEATURE GROUP A (FGA)

A. Description

1. FGA Access, which is available to all customers, provides a lineside termination to Company end office switches for the customer's use in originating communications from and terminating communications to an Interexchange Carrier's intrastate service or a customer-provided intrastate communications capability. The customer must specify the Interexchange Carrier to which the FGA Service is connected or, in the alternative, specify the means by which the FGA access communication is transported to another LATA.
2. FGA is provided in connection with Company electronic and electromechanical end offices. FGA may be transported via a DS3, DS1 or Voice Grade Entrance Facility and via a DS3, DS1 or Voice Grade DTT facility. When the customer orders FGA and Trunkside Access to be transported via the same DTT facility, DS1 to Voice Grade multiplexing equipment is always required at the end office at the rates and charges set forth in 6.8, following. When the customer does not combine FGA and Trunkside Access on the same facility, the Company will provide DS1 to Voice Grade multiplexing equipment at no charge. At the option of the customer, FGA is provided on a single or multiple line group basis and is arranged for originating calling only, terminating calling only, or two-way calling.
3. FGA provides a lineside termination at the first point of switching. The lineside termination will be provided with either ground start supervisory signaling or loop start supervisory signaling. The type of signaling is at the option of the customer.
4. The Company shall select the first point of switching, within the selected LATA, at which the lineside termination is to be provided unless the customer requests a different first point of switching and Company facilities and measurement capabilities are available to accommodate such a request.
5. A seven-digit local telephone number assigned by the Company is provided for access to FGA switching in the originating direction. The seven-digit local telephone number will be associated with the selected end office switch and is of the form NXX-XXXX.

If the customer requests a specific seven-digit telephone number that is not currently assigned, and the Company can, with reasonable effort, comply with that request, the requested number will be assigned to the customer.

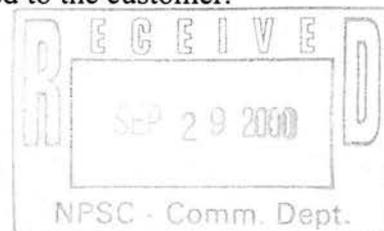

NOTICE

THE INFORMATION CONTAINED IN THIS DOCUMENT IS SUBJECT TO CHANGE.

6. SWITCHED ACCESS SERVICE

6.2 PROVISION AND DESCRIPTION OF SWITCHED ACCESS SERVICE

6.2.1 FEATURE GROUP A (FGA)

A. Description (Cont'd)

6. FGA switching, when used in the terminating direction, is arranged with dial tone start-dial signaling. When used in the terminating direction, FGA switching may, at the option of the customer, be arranged for dial pulse or dual tone multifrequency address signaling, subject to availability of equipment at the first point of switching. When FGA switching is provided in a hunt group or uniform call distribution arrangement, all FGA switching will be arranged for the same type of address signaling.
7. No address signaling is provided by the Company when FGA switching is used in the originating direction. Address signaling in such cases, if required by the customer, must be provided by the customer's end user using inband tone signaling techniques. Such inband tone address signals will not be regenerated by the Company and will be subject to the ordinary transmission capabilities of the Switched Transport provided.
8. FGA switching, when used in the terminating direction, may be used to access valid NXXs in the LATA, local operator service (0- and 0+), Voice DA (411 or 555-1212, whichever is available), emergency reporting service (911 where available), exchange telephone repair (611 where available), community information services of an information service provider, and other customers' services (by dialing the appropriate digits). Charges for FGA terminating calls requiring operator assistance or calls to 611 or 911 will only apply where sufficient call details are available. Additional non-access charges will also be billed on a separate account for:
 - a. An operator surcharge, as set forth in the Exchange and Network Services Catalog, for local operator assistance (0- and 0+) calls,
 - b. Calls to certain community information services in accordance with the Information Provider's applicable service rates when the Company performs the billing function for the Information Provider,
 - c. Calls from an FGA line to another customer's service in accordance with that customer's applicable service rates when the Company performs the billing function for that customer.
9. FGA calls terminating outside of the dial tone office are assessed Tandem Transmission rates in addition to the applicable Switched Access rates when calls are terminated within the dial tone office. Tandem Transmission mileage measurement is described in 6.7.11, following.
10. FGA calls to Voice DA (411 or 555-1212, whichever is available), are subject to the Voice DA Service Call rate as set forth in 9.6, following, and are not subject to Switched Access usage rates as set forth in herein.

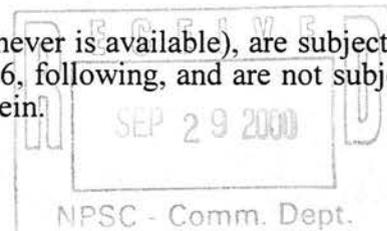

NOTICE

THE INFORMATION CONTAINED IN THIS DOCUMENT IS SUBJECT TO CHANGE.

6. SWITCHED ACCESS SERVICE

6.2 PROVISION AND DESCRIPTION OF SWITCHED ACCESS SERVICE

6.2.1 FEATURE GROUP A (FGA)

A. Description (Cont'd)

11. When an FGA switching arrangement for an individual customer (a single line or entire hunt group) is discontinued at an end office, an intercept announcement is provided. This arrangement provides, for a limited period of time, an announcement that the service associated with the number dialed has been disconnected.
12. FX/ONAL FGA switching can be ordered by an end user when used in conjunction with an FX service or an Off Network Access Line (ONAL) Service. FX/ONAL FGA charges will be billed to the end user. FX/ONAL FGA Switching is not permitted for use with the provisioning of MTS/WATS-type service.
13. Use of certain optional features, available in B., following, may result in additional usage charges. For example, if a customer orders Three-Way Calling, additional Switched Access, Service usage rates could apply if the customer establishes two calls.

B. Optional Features

1. Switched Transport Optional Features

- Supervisory Signaling
- Customer Specified Entry Switch Receive Level

2. Common Switching Optional Features

- Call Denial
- Service Code Denial
- Hunt Group Arrangement
- Uniform Call Distribution Arrangement
- Nonhunting Number for Use with Hunt Group Arrangement or Uniform Call Distribution Arrangement
- InterLATA Toll Denial

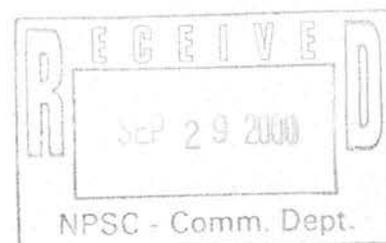

6. SWITCHED ACCESS SERVICE

6.2 PROVISION AND DESCRIPTION OF SWITCHED ACCESS SERVICE

6.2.1 FEATURE GROUP A (FGA)

B. Optional Features (Cont'd)

3. Transport Termination Optional Features

- Two-way operation with dial pulse address signaling and loop start supervisory signaling
- Two-way operation with dial pulse address signaling and ground start supervisory signaling
- Two-way operation with dual tone multifrequency address signaling and loop start supervisory signaling
- Two-way operation with dual tone multifrequency address signaling and ground start supervisory signaling
- Terminating operation with dial pulse address signaling and loop start supervisory signaling
- Terminating operation with dial pulse address signaling and ground start supervisory signaling
- Terminating operation with dual tone multifrequency address signaling and loop start supervisory signaling
- Terminating operation with dual tone multifrequency address signaling and ground start supervisory signaling
- Originating operation with loop start supervisory signaling
- Originating operation with ground start supervisory signaling

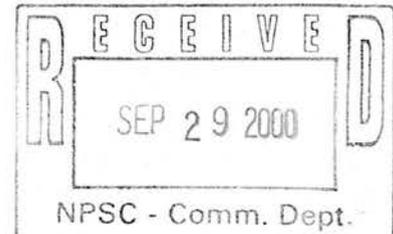

6. SWITCHED ACCESS SERVICE

6.2 PROVISION AND DESCRIPTION OF SWITCHED ACCESS SERVICE

6.2.1 FEATURE GROUP A (FGA)

B. Optional Features (Cont'd)

4. When technically feasible and operating conditions permit, certain other features which may be available in connection with Feature Group A are provided under the Company's Exchange and Network Service Catalog. These are:

- Bill Number Screening
- Open Switching Interval Protection (OSIP)
- Message Delivery Service
- Message Waiting Indication - Audible
- Queuing on UCD
- Delay Announcement on UCD
- Music on Queue on UCD
- Abbreviated Access/Activation
- Answer Supervision - Lineside
- Call Forwarding - Busy Line
- Call Forwarding - Busy Line (Expanded)
- Call Forwarding - Busy Line/Don't Answer
- Call Forwarding - Busy Line/Don't Answer (Expanded)
- Call Forwarding - Don't Answer
- Call Forwarding - Don't Answer (Expanded)
- Call Forwarding - Variable
- Call Rejection
- Call Transfer
- Call Waiting

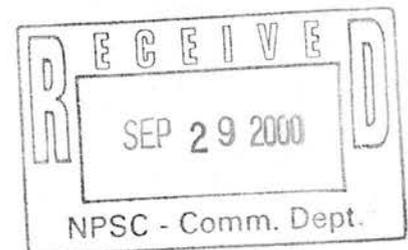

6. SWITCHED ACCESS SERVICE

6.2 PROVISION AND DESCRIPTION OF SWITCHED ACCESS SERVICE

6.2.1 FEATURE GROUP A (FGA)

B.4. (Cont'd)

- Caller Identification - Bulk
- Caller Identification - Number
- Continuous Redial
- Custom Ringing
- Dial Call Waiting
- Directed Call Pickup
- Directed Call Pickup with Barge-In
- Distinctive Alert
- Hot Line
- Last Call Return
- Make Busy
- Message Waiting Indication - Visual
- Network Access Service (960)
- Priority Call
- Selective Call Forwarding
- Speed Calling (8 Number)
- Speed Calling (30 Number)
- Three-Way Calling
- Warm Line
- Message Waiting Indication - Audible/Visual

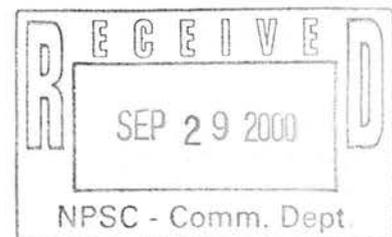

6. SWITCHED ACCESS SERVICE

6.2 PROVISION AND DESCRIPTION OF SWITCHED ACCESS SERVICE
6.2.1 FEATURE GROUP A (FGA) (Cont'd)

C. Transmission Performance

FGA is provided with either Transmission Type B or Type C performance. The standard parameter limits associated with these Transmission Types are guaranteed to the first point of switching. Transmission Type C performance is provided with Interface Group 1 and Transmission Type B performance is provided with Interface Groups 2, 6 and 9, as available. Voice band Data Transmission Type DB parameter limits are provided with FGA to the first point of switching as delineated in Technical Reference GR-334-CORE.

D. Testing Capabilities

FGA is provided, in the terminating direction where equipment is available, to balance (100-type) test line and milliwatt (102-type) test line. In addition to the tests described in 6.1.5, preceding, which are included with the installation of service, additional Cooperative Acceptance and Non-Scheduled Testing are available as set forth in 13.3.5, following.

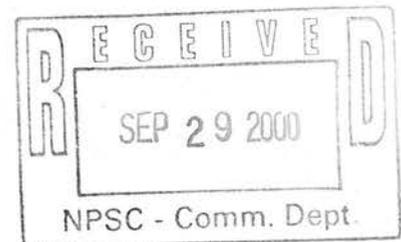

6. SWITCHED ACCESS SERVICE

6.2 PROVISION AND DESCRIPTION OF SWITCHED ACCESS SERVICE (Cont'd)

6.2.2 FEATURE GROUP B (FGB)

A. Description

1. FGB Access, which is available to all customers, provides a trunkside termination to Company end office switches for the customer's use in originating communications from and terminating communications to an Interexchange Carrier's intrastate service or a customer-provided intrastate communications capability. The customer must specify the Interexchange Carrier to which the FGB Service is connected or, in the alternative, specify the means by which FGB Access communication is transported to another LATA.
2. FGB, when directly routed to an end office (via DTT), is provided at appropriately equipped Company electronic end office switches. When provided via Company designated electronic access tandem switches with TST, FGB switching is provided at Company electronic and electromechanical end office switches.
3. When Feature Group B service is directly routed to an end office, the Switched Transport configuration is composed of an Entrance Facility and a DTT facility to an end office. When Feature Group B is switched through an access tandem, the Switched Transport configuration is composed of an Entrance Facility, a DTT facility between the SWC and the access tandem and TST from the access tandem to the end offices subtending the access tandem. Multiplexing options are described in 6.1.2, preceding.
4. FGB is provided as a trunkside termination through the use of end office or access tandem switch trunk equipment. The switch trunk equipment is provided with wink-start start-pulsing signals and answer and disconnect supervisory signaling.
5. FGB switching is provided with multifrequency (MF) address signaling in both the originating and terminating directions. Address signals and address information required by the customer must be provided by the customer's end user using inband tone signaling techniques. Such inband tone address signals will not be regenerated by the Company and will be subject to the ordinary transmission capabilities of the Switched Transport provided.
6. The access code for non-8XX FGB switching is a uniform access code. The form of the uniform access code is 950-XXXX or 1 + 950-XXXX for carriers. These uniform access codes will be the assigned access numbers of all non-8XX FGB switching provided to the customer by the Company. No access code is required for FGB switching used to provide 800 DB Access Service. The telephone number dialed by the customer's end users is of the form 1+8XX+NXX+XXXX.

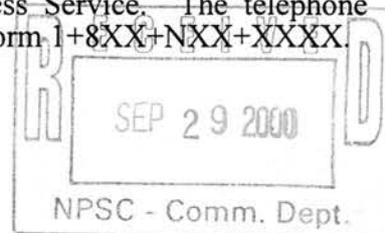

NOTICE

THE INFORMATION CONTAINED IN THIS DOCUMENT IS SUBJECT TO CHANGE.
NE2000-054

6. SWITCHED ACCESS SERVICE

6.2 PROVISION AND DESCRIPTION OF SWITCHED ACCESS SERVICE

6.2.2 FEATURE GROUP B (FGB)

A. Description (Cont'd)

7. FGB switching, when used in the terminating direction, may be used to access valid NXX codes in the LATA, community information services of an information service provider, and other customers' services (by dialing the appropriate digits). When FGB is directly routed to an end office via DTT, only those valid NXX codes served by that end office may be accessed. When FGB is routed through an access tandem, only those valid NXX codes served by end offices subtending the access tandem may be accessed. Additionally, non-access charges will also be billed for calls from a FGB trunk to another customer's service in accordance with that customer's applicable service rates when the Company performs the billing function for that customer. Calls in the terminating direction will not be completed to 101XXXX, 950-XXXX (or 1 + 950-XXXX) access codes, local operator assistance (0- and 0+), Voice DA (411 or 555-1212 where available) and service codes 611 and 911. Calls will be completed to Voice DA (NPA+555-1212 or 555-1212) when FGB switching is combined with Voice DA Switching. The combination of FGB Switched Access Service with Voice DA Service is provided as set forth in Section 9, following. FGB may not be switched, in the terminating direction, to another Trunkside Switched Access Service.
8. The Company will establish a trunk group or groups for the customer at end office switches or access tandem switches where FGB switching is provided. When required by technical limitations, a separate trunk group will be established for each type of FGB switching arrangement provided. Different types of FGB or other switching arrangements may be combined in a single trunk group at the option of the Company.
9. When all FGB switching arrangements are discontinued at an end office and/or in a LATA, an intercept announcement is provided. This arrangement provides, for a limited period of time, an announcement that the service associated with the number dialed has been disconnected.

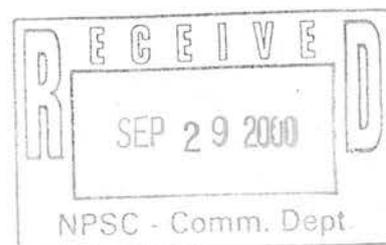

NOTICE

THE INFORMATION CONTAINED IN THIS DOCUMENT IS SUBJECT TO CHANGE.
NE2000-054

6. SWITCHED ACCESS SERVICE

6.2 PROVISION AND DESCRIPTION OF SWITCHED ACCESS SERVICE

6.2.2 FEATURE GROUP B (FGB) (Cont'd)

B. Optional Features

1. Switched Transport Optional Features

- Customer Specification of Switched Transport Termination
- Supervisory Signaling
- Customer Specified Entry Switch Receive Level

2. Common Switching Optional Features

- Automatic Number Identification (ANI)
- Up to 7 digit Outpulsing of Access Digits to customer
- Alternate Traffic Routing

3. Another feature, Bill Number Screening, which may be available in connection with FGB, is provided under the Company's Exchange and Network Services Catalog.

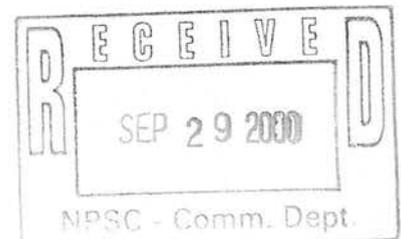

NOTICE

THE INFORMATION CONTAINED IN THIS DOCUMENT IS SUBJECT TO CHANGE.
NE2000-054

6. SWITCHED ACCESS SERVICE

6.2 PROVISION AND DESCRIPTION OF SWITCHED ACCESS SERVICE

6.2.2 FEATURE GROUP B (FGB) (Cont'd)

C. Transmission Performance

FGB is provided with Transmission Type B1 performance. Transmission Type B1 standard parameter limits apply to the transmission path routed directly (i.e., between the customer's premises and the end office) and to each segment of an access tandem connection. Transmission Type B1 performance is provided with Interface Groups 1, 2, 6 and 9, as available. Voice band data Transmission Type DB1 parameter limits are provided with FGB when routed directly and to each segment of an access tandem connection as delineated in Technical Reference GR-334-CORE.

D. Testing Capabilities

FGB is provided, in the terminating direction where equipment is available, with seven-digit access to balance (100 type) test line, milliwatt (102 type) test line, nonsynchronous or synchronous test line, automatic transmission measuring (105 type) test line, data transmission (107 type) test line, loop around test line, short circuit test line and open circuit test line. In addition to the tests described in 6.1.5, preceding, which are included with the installation of service, additional Cooperative Acceptance Testing, Automatic Scheduled Testing, Cooperative Scheduled Testing, Manual Scheduled Testing and Non-Scheduled Testing are available as set forth in 13.3.5, following.

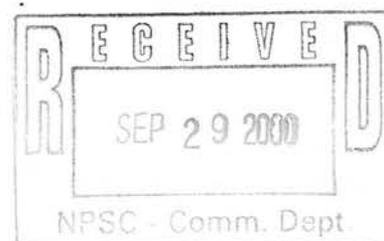

6. SWITCHED ACCESS SERVICE

6.2 PROVISION AND DESCRIPTION OF SWITCHED ACCESS SERVICE (Cont'd)

6.2.3 FEATURE GROUP C (FGC)

A. Description

1. FGC Access, which is available only to providers of MTS and WATS, provides a trunkside termination to Company end office switches for the customer's use in originating and terminating communications.
2. FGC is provided at all Company end office switches on a direct trunk basis via DTT or via Company designated access tandem switches with TST. FGC switching is provided to the customer (i.e., providers of MTS and WATS) at an end office switch unless Feature Group D end office switching is provided in the same office. When FGD switching is available, FGC switching will not be provided.
3. When Feature Group C service is directly routed to an end office, the Switched Transport configuration is composed of an Entrance Facility and a DTT facility to an end office. When Feature Group C is switched through an access tandem, the Switched Transport configuration is composed of an Entrance Facility, a DTT facility between the SWC and the access tandem and TST from the access tandem to the end offices subtending the access tandem. Multiplexing options are described in 6.1.2, preceding.
4. FGC is provided as a trunkside termination through the use of end office or access tandem switch trunk equipment. The switch trunk equipment is provided with answer and disconnect supervisory signaling. Wink-start start-pulsing signals are provided in all offices where available. In those offices where wink-start start-pulsing signals are not available, delay-dial start-pulse signaling is provided, or immediate dial-pulse address signaling may be provided, which allows dial-pulses to be forwarded without a start-pulsing signal from the terminating office.
5. FGC is provided with MF address signaling except in certain electromechanical end office switches where multifrequency signaling is not available. In such switches, the address signaling will be dial-pulse, or immediate dial pulse, whichever is available. Up to 12 digits of the called party number will be forwarded by Company equipment to the customer's premises. Such called party number signals will be subject to the transmission and signaling capabilities of the Switched Transport provided.

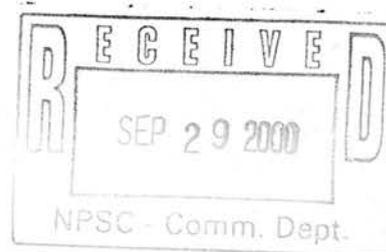

Qwest Corporation
Access Service
Catalog

SECTION 6

Page 49

Release 1

State of Nebraska
Notified: 9-29-2000

Effective: 9-29-2000

6. SWITCHED ACCESS SERVICE

6.2 PROVISION AND DESCRIPTION OF SWITCHED ACCESS SERVICE

6.2.3 FEATURE GROUP C (FGC)

A. Description (Cont'd)

6. No access code is required for FGC switching. The telephone number dialed by the customer's end user shall be a seven- or ten-digit number for calls in the North American Numbering Plan (NANP). The form of the numbers dialed by the customer's end user is NXX-XXXX, 0 or 1 + NXX-XXXX, NPA + NXX-XXXX, 0 or 1 + NPA + NXX-XXXX.
7. FGC switching, when used in the terminating direction, may be used to access valid NXX codes in the LATA, community information services of an Information Service Provider, and other customers' services (by dialing the appropriate codes) when the services can be reached using valid NXX codes. When FGC is directly routed to an end office via DTT, only those valid NXX codes served by that end office may be accessed. When FGC is routed through an access tandem, only those valid NXX codes served by end offices subtending the access tandem may be accessed.

Additionally, non-access charges will also be billed for calls from a FGC trunk to another customer's service in accordance with that customer's applicable service rates when the Company performs the billing function for that customer. Calls in the terminating direction will not be completed to 101XXXX, 950-XXXX (or 1 + 950-XXXX) access codes, local operator assistance (0- and 0+), Voice DA (411 or 555-1212) and service codes 611 and 911. Calls will be completed to Voice DA (NPA+555-1212 or 555-1212) when FGC switching is combined with Voice DA switching. The combination of FGC Switched Access Service with Voice DA Service is provided as set forth in Section 9, following. FGC may not be switched, in the terminating direction, to another Trunkside Switched Access Service.

8. The Company will establish a trunk group or groups for the customer at end office switches or access tandem switches where FGC switching is provided. When required by technical limitations, a separate trunk group will be established for each type of FGC switching arrangement provided. Different types of FGC or other switching arrangements may be combined in a single trunk group at the option of the Company.

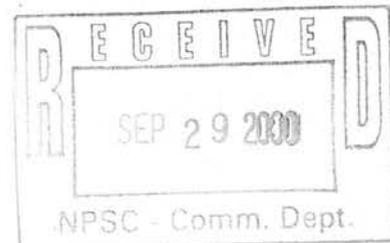

NOTICE

THE INFORMATION CONTAINED IN THIS DOCUMENT IS SUBJECT TO CHANGE.
NE2000-054

6. SWITCHED ACCESS SERVICE

6.2 PROVISION AND DESCRIPTION OF SWITCHED ACCESS SERVICE

6.2.3 FEATURE GROUP C (FGC)

A. Description (Cont'd)

- 9. The Company will provide 0+ and 0- intraLATA access from pay telephones utilizing Smart Public Access Lines via FGC for calls dialed as 0+ or 0- and/or 101XXXX 1+ in the following manner. 1+ interLATA sent-paid access from pay telephones utilizing Basic Public Access Lines Service shall be provided by FGD. (C)

a. Smart Public Access Line (PAL)

For traffic originating from a Smart PAL, the customer to whom such calls are routed shall order FGC trunks from end offices to the customer's premises via direct trunks or via Operator Access Tandems, with the Operator Trunk-Full Feature type of transport termination, as set forth in 6.3.2, following. The trunks must be dedicated, and the customer shall specify the number of trunks required at each end office from which the customer will receive 0+ or 0- traffic. (C)

The customer is responsible for providing all other operator services signaling capabilities, as described in the Operator Services Systems Generic Requirements (OSSGR) Technical Reference FR-271 and the LATA Switching Systems Generic Requirements (LSSGR) Technical Reference FR-64.

When the Company provides Operator Services Signaling (OSS) between an Operator Access Tandem and the customer's premises, the customer will be required to order a separate and final trunk group from the Operator Access Tandem to the customer's premises for each Numbering Plan Area (NPA) within a LATA to identify the originating NPA. Also, the customer must order a separate trunk group for each type of coin control signaling that is utilized among the equal access end offices subtending an Operator Access Tandem.

The Company will not block 101XXXX 0+ or 0- calls and will route 101XXXX traffic in accordance to the end user request. It will be the responsibility of the 101XXXX 1+ dialed carrier to complete the casual 101XXXX intraLATA call or to provide a recorded message to the end user. (C)

Qwest Corporation d/b/a CenturyLink QC
Access Service
Catalog

(T)

SECTION 6
Page 51
Release 3
Effective: 3-12-2018

State of Nebraska
Notified: 3-2-2018

6. SWITCHED ACCESS SERVICE

- 6.2 PROVISION AND DESCRIPTION OF SWITCHED ACCESS SERVICE**
- 6.2.3 FEATURE GROUP C (FGC)**
- A.9. (Cont'd)

(D)

(D)

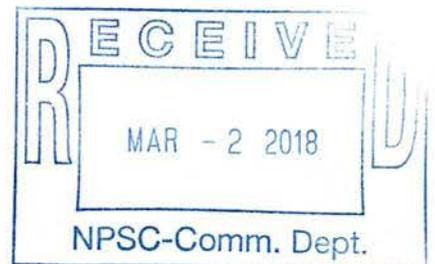

6. SWITCHED ACCESS SERVICE

6.2 PROVISION AND DESCRIPTION OF SWITCHED ACCESS SERVICE

6.2.3 FEATURE GROUP C (FGC) (Cont'd)

B. Optional Features

1. Switched Transport Optional Features

- Supervisory Signaling
- MPTS

2. Common Switching Optional Features

- Automatic Number Identification (ANI)
- Delay Dial Start-Pulsing Signaling
- Immediate dial Pulse Address Signaling
- Dial Pulse Address Signaling
- Service Class Routing
- Alternate Traffic Routing
- Trunk Access Limitation
- WATS Access Service

3. Transport Termination Optional Features

- Operator Trunks - (i.e., Coin, Non-Coin or Combined Coin and Non-Coin)

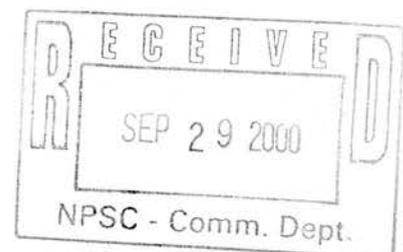

6. SWITCHED ACCESS SERVICE

6.2 PROVISION AND DESCRIPTION OF SWITCHED ACCESS SERVICE

6.2.3 FEATURE GROUP C (FGC) (Cont'd)

C. Transmission Performance

FGC is provided with Transmission Type B1 performance. Transmission Type B1 standard parameter limits apply to the transmission path routed directly (i.e., between the customer's premises and the end office) and to each segment of an access tandem connection. Transmission Type B1 performance is provided with Interface Group 1, 2, 6 and 9, as available. Voice band data Transmission Type DB1 parameter limits are provided with FGC when directly routed and to each segment of an access tandem connection as delineated in Technical Reference GR-334-CORE.

D. Testing Capabilities

FGC is provided, in the terminating direction where equipment is available, with seven-digit access to balance (100 type) test line, milliwatt (102 type) test line, nonsynchronous or synchronous test line, automatic transmission measuring (105 type) test line, data transmission (107 type) test line, loop around test line, short circuit test line and open circuit test line. In addition to the tests described in 6.1.5 preceding which are included with the installation of service, additional Cooperative Acceptance Testing, Automatic Scheduled Testing, Cooperative Scheduled Testing or Manual Scheduled Testing, and Non-Scheduled Testing are available as set forth in 13.3.5, following for FGC.

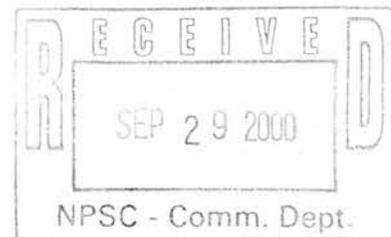

Qwest Corporation
Access Service
Catalog

SECTION 6
Page 54
Release 2

State of Nebraska
Notified: March 3, 2005

Effective: March 14, 2005

6. SWITCHED ACCESS SERVICE

6.2 PROVISION AND DESCRIPTION OF SWITCHED ACCESS SERVICE (Cont'd)

6.2.4 FEATURE GROUP D (FGD)

A. Description

1. FGD is provided at Company designated end office switches whether routed directly to an end office or via Company designated electronic access tandem switches.
2. FGD, which is available to all customers, provides a trunkside termination through the use of end office or access tandem switch trunk equipment. Wink-start, start-pulsing and answer-supervisory signaling are sent by the terminating office. Disconnect-supervisory signaling is sent from the originating or terminating office. When FGD uses SS7 out of band signaling, no signaling will be done via the message channel.
3. When Feature Group D service is directly routed to an end office, the Switched Transport configuration is composed of an Entrance Facility and a DTT facility to an end office. When Feature Group D is switched through an access tandem, the Switched Transport configuration is composed of an Entrance Facility, a DTT facility between the SWC and the access tandem and TST from the access tandem to the end offices subtending the access tandem. Multiplexing options are described in 6.1.2, preceding.
4. FGD switching is provided with MF address signaling or SS7 Out of Band Signaling. Up to 12 digits of the called party number dialed by the customer's end user using dual tone multifrequency or dial pulse address signals will be provided by Company equipment to the customer's premises where the Switched Access Service terminates. Such address signals will be subject to the ordinary transmission capabilities of the Switched Transport provided. With SS7 Out of Band Signaling, up to 12 digits of the called party number dialed by the customer's end user using dual tone multifrequency or dial pulse address signals is provided by the Company equipment to the customer's designated premises via CCSAC links. SS7 Out of Band Signaling requires the customer to order the SS7 Out of Band Signaling optional feature, as set forth in 6.3, following, and CCSAC Service as set forth Section 15, following.

(C)

(C)

(M)

(M) Material moved to Page 54.1.



NOTICE

THE INFORMATION CONTAINED IN THIS DOCUMENT IS SUBJECT TO CHANGE
NE2005-006

Qwest Corporation
Access Service
Catalog

SECTION 6
Page 54.1
Release 1

State of Nebraska
Notified: March 3, 2005

Effective: March 14, 2005

6. SWITCHED ACCESS SERVICE

6.2 PROVISION AND DESCRIPTION OF SWITCHED ACCESS SERVICE (Cont'd)

6.2.4 FEATURE GROUP D (FGD)

A. Description(Cont'd)

5. FGD switching, when used in the terminating direction, may be used to access valid NXX codes in the LATA, community information services of an Information Service Provider, and other customer services (by dialing the appropriate codes) when such services can be reached using valid NXX codes. When FGD is directly routed to an end office via DTT, only those valid NXX codes served by that end office may be accessed. When FGD is routed through an access tandem, only those valid NXX codes served by end offices subtending the access tandem may be accessed.

(M)

Terminating FGD, with tandem routing, may also, at the option of the customer, access valid NXX codes served by end offices in which originating FGD is not available. Rating of this optional service is as set forth in 6.7.1.D., following.

(M)

Additionally, non-access charges will also be billed for calls from a FGD trunk to another customer's service in accordance with that customer's applicable service rates when the Company performs the billing function for that customer. Calls in the terminating direction will not be completed to 101XXXX, 950-XXXX (or 1 + 950-XXXX) access codes, local operator assistance (0- and 0+), Voice DA (411 or 555-1212) and service codes 611 and 911. Calls will be completed to Voice DA (NPA+555-1212 or 555-1212) when FGD switching is combined with Voice DA Switching. The combination of FGD Switched Access Service with Voice DA Service is provided as set forth in Section 9, following. FGD may not be switched, in the terminating direction, to another Trunkside Switched Access Service.

(M1)

(M1)

(M) Material moved from Page 54.

(M1) Material moved from Page 55.



NOTICE

THE INFORMATION CONTAINED IN THIS DOCUMENT IS SUBJECT TO CHANGE.

6. SWITCHED ACCESS SERVICE

6.2 PROVISION AND DESCRIPTION OF SWITCHED ACCESS SERVICE

6.2.4 FEATURE GROUP D (FGD)

A.5. (Cont'd)

- (M)
6. The Company will establish a trunk group or groups for the customer at end office switches or access tandem switches where FGD switching is provided. When required by technical limitations, or in the case of *SWITCHNET 56*, a separate trunk group will be established for each type of FGD switching arrangement provided. Different types of FGD or other switching arrangements may be combined in a single trunk group at the option of the Company.
 7. The uniform access code for FGD switching is 101XXXX. These uniform access codes will be the assigned access numbers of all FGD access provided to the customer by the Company. No access code is required for calls to a customer over FGD Switched Access Service if the end user's Telephone Exchange Service is arranged for presubscription as set forth in Section 13, following.

Where no access code is required, the number dialed by the customer's end user shall be a seven- or ten-digit number for calls in the North American Numbering Plan (NANP). The form of the numbers dialed by the customer's end user is NXX-XXXX, 0, 00 or 1 + NXX-XXXX, NPA + NXX-XXXX, 0, 00 or 1 + NPA + NXX-XXXX.

When the 101XXXX access code is used, FGD switching also provides for dialing the digit 0 or 00 for access to the customer's operator, 911 for access to the Company's emergency reporting service, or at the customer's option, the end-of-dialing digit (#) for cut-through access to the customer's premises.

(M) Material moved to Page 54.1.



NOTICE

THE INFORMATION CONTAINED IN THIS DOCUMENT IS SUBJECT TO CHANGE.

6. SWITCHED ACCESS SERVICE

6.2 PROVISION AND DESCRIPTION OF SWITCHED ACCESS SERVICE

6.2.4 FEATURE GROUP D (FGD)

A. Description (Cont'd)

8. When *SWITCHNET 56* is provided with FGD, the standard FGD dialing pattern is used.
9. FGD switching will be arranged to accept calls from telephone exchange service locations without the need for dialing a 101XXXX uniform access code. Each telephone exchange service line may be marked with a presubscription code to identify the 101XXXX uniform code its calls will be directed to for interLATA service. Presubscription codes are applied as set forth in Section 13, following.
10. When a customer has had FGB access in an end office and subsequently replaces the FGB access with FGD access, at the mutual agreement of the customer and the Company, the Company will, for a period of 90 days after the installation of the FGD access service (unless the customer requests a shorter period), direct calls dialed by the customer's end users using the customer's previous FGB access code to the customer's FGD access service. The customer must be prepared to handle normally dialed FGD calls as well as calls dialed with the FGB access code which require the customer to receive additional address signaling from the end user. The customer must be prepared to handle both the FGB and FGD signaling on the same trunks. Such calls will be rated as FGD.

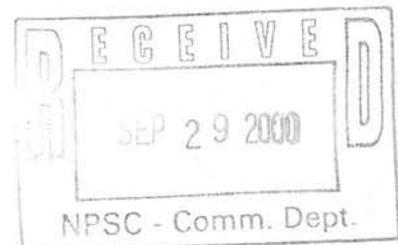

NOTICE

THE INFORMATION CONTAINED IN THIS DOCUMENT IS SUBJECT TO CHANGE.
NE2000-054

6. SWITCHED ACCESS SERVICE

6.2 PROVISION AND DESCRIPTION OF SWITCHED ACCESS SERVICE

6.2.4 FEATURE GROUP D (FGD)

A. Description (Cont'd)

11. The Company will provide 1+ interLATA sent-paid access from equal access end offices to the customer's premises for calls dialed as 1+ and/or 101XXXX 1+ from pay telephones utilizing PAL Service, Smart and Basic, in the following manner.

- a. Smart PAL

For traffic originating from a Smart PAL, the customer to whom such calls are routed shall order FGD trunks from equal access end offices to the customer's premises via direct trunks or via Operator Access Tandems, with the Operator Trunk-Full Feature type of transport termination, as set forth in 6.3.2, following. The trunks must be dedicated, and the customer shall specify the number of trunks required at each end office from which the customer will receive 1+ sent-paid traffic.

The customer is responsible for providing all other operator services signaling capabilities, as described in the Operator Services Systems Generic Requirements (OSSGR) Technical Reference FR-271 and the LATA Switching Systems Generic Requirements (LSSGR) Technical Reference FR-64.

When the Company provides Operator Services Signaling (OSS) between an Operator Access Tandem and the customer's premises, the customer will be required to order a separate and final trunk group from the Operator Access Tandem to the customer's premises for each Numbering Plan Area (NPA) within a LATA to identify the originating NPA. Also, the customer must order a separate trunk group for each type of coin control signaling that is utilized among the equal access end offices subtending an Operator Access Tandem.

The Company will not block 101XXXX 1+ calls and will route 101XXXX 1+ interLATA sent-paid traffic in accordance to the end user request. It will be the responsibility of the 101XXXX 1+ dialed carrier to complete the casual 101XXXX 1+ interLATA sent-paid call or to provide a recorded message to the end user.

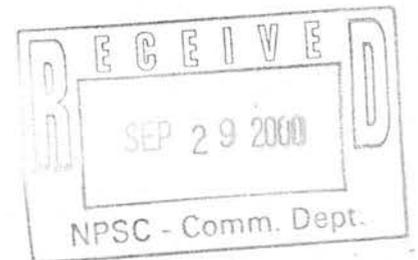

NOTICE

Qwest Corporation
Access Service
Catalog

SECTION 6
Page 58
Release 2
Effective: 7-1-2016

State of Nebraska
Notified: 6-1-2016

6. SWITCHED ACCESS SERVICE

6.2 PROVISION AND DESCRIPTION OF SWITCHED ACCESS SERVICE

6.2.4 FEATURE GROUP D (FGD)

A.11.a. (Cont'd)

The Company will perform normal acceptance testing for sent-paid services for Smart PALs. In addition, the Company will perform testing for coin control and Operator Trunk-Full Feature (i.e., coin collect, coin return, 1+ person-to-person, operator recall, overtime and information calls). Test data files must be received from the customer that will be processing the 1+ interLATA sent-paid traffic 45 days prior to the routing of said 1+ traffic to that customer. The Company will provide optional testing, at the request of the customer, as set forth in Section 13, following.

(C)

b. Basic PAL

For traffic originating from a Basic PAL, the Company shall provide 1+ interLATA sent-paid access from equal access end offices to the customer's premises via FGD trunks. For traffic originating from a Basic PAL dialed as 1+ and/or 101XXXX 1+, the customer to whom such calls are routed shall order or have existing FGD trunks with ANI optional feature, as set forth in 6.3.1, following.

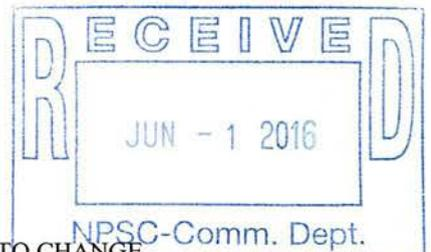

6. SWITCHED ACCESS SERVICE

6.2 PROVISION AND DESCRIPTION OF SWITCHED ACCESS SERVICE

6.2.4 FEATURE GROUP D (FGD) (Cont'd)

B. Optional Features

1. Switched Transport Optional Features

- Supervisory Signaling
- MPTS

2. Common Switching Optional Features

- Automatic Number Identification (ANI)
- Cut-Through
- Service Class Routing
- Alternate Traffic Routing
- Trunk Access Limitation
- *SWITCHNET 56* Service
- WATS Access Service
- SS7 Out of Band Signaling
- Clear Channel Capability
- International Carrier Option

3. Transport Termination Optional Features

- Operator Trunks - (i.e., Coin, Non-Coin, or Combined Coin & Non-Coin)
- Operator Trunk, Full Feature Arrangement

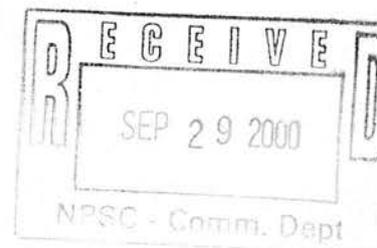

6. SWITCHED ACCESS SERVICE

6.2 PROVISION AND DESCRIPTION OF SWITCHED ACCESS SERVICE

6.2.4 FEATURE GROUP D (FGD) (Cont'd)

C. Transmission Performance

FGD is provided with either Transmission Type A1 or Type B1 performance as follows:

- When routed directly to the end office, Transmission Type B1 is provided.
- When routed to an access tandem, only Transmission Type A1 is provided for both the POT-to-access tandem and access tandem-to-end office trunks.
- Overall POT to end office requirements for FGD provide Transmission Type B1 performance whether routed directly with Transmission Type B1 or via an access tandem with Transmission Type A1.

Transmission Type B1 performance is provided with Interface Group 1, 2, 6, and 9, as available. Transmission Type A1 performance is provided with Interface Groups 2, 6 and 9, as available.

Voice band data Transmission Type DB1 parameter limits are provided with FGD for the transmission path between the customer's premises and the end office when directly routed to the end office. Voice band data Transmission Type DA1 parameter limits are provided for the transmission path between the customer's premises and the access tandem and between the access tandem and the end office. Voice band data transmission parameter limits are delineated in Technical Reference GR-334-CORE.

D. Testing Capabilities

FGD is provided, in the terminating direction where equipment is available, with seven digit access to balance (100 type) test line, milliwatt (102 type) test line, nonsynchronous or synchronous test line, automatic transmission measuring (105 type) test line, data transmission (107 type) test line, loop around test line, short circuit test line, open circuit test line, and non-inverting digital loopback (108 type) test line.

In addition to the tests described in 6.1.5, preceding, which are included with the installation of service, additional Cooperative Acceptance Testing, Automatic Scheduled Testing, Cooperative Scheduled Testing, or Manual Scheduled Testing, and Non-Scheduled Testing, are available for FGD as set forth in 13.3.5, following.

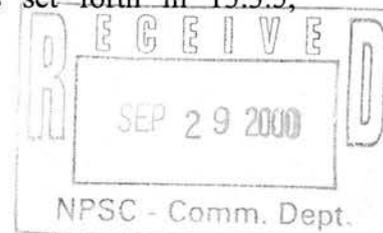

NOTICE

THE INFORMATION CONTAINED IN THIS DOCUMENT IS SUBJECT TO CHANGE.
NE2000-054

6. SWITCHED ACCESS SERVICE

6.2 PROVISION AND DESCRIPTION OF SWITCHED ACCESS SERVICE (Cont'd)

6.2.5 800 DATA BASE ACCESS SERVICE

A. General Description

800 Data Base (800 DB) Access Service is an originating service utilizing trunkside Switched Access Service which provides for the forwarding of end user dialed 8XX+NXX-XXXX calls to a customer based on the dialed 8XX number. 800 DB Access Service must be ordered to all end offices in a LATA and provisioned, at a minimum, to all access tandems and operator switches equipped as SSPs within a LATA. If the customer is utilizing another carrier's facilities to meet the LATA-wide minimum requirement, the customer must provide a letter signed by the access customer ordering the 800 DB Access Service and the partnering carrier indicating LATA-wide coverage. In addition, the provision of 800 DB Access Service requires the customer's direct access to the Service Management System/800 (SMS/800), or as an alternative, the provision of such service by a Responsible Organization in accordance with the Guidelines for 800 Data Base.

When an 8XX call is originated by an end user, the Company will perform the customer identification function based on the dialed digits to determine the customer location to which the call is to be routed in accordance with SMS/800 information residing in the Company's Service Control Point (SCP).

The customer has the option of having the dialed 8XX number (i.e., 8XX+NXX-XXXX or the translated Plain Old Telephone Service (POTS) number (i.e., NPA+NXX-XXXX) delivered. If the translated POTS number is delivered, the customer must request the POTS Translation vertical feature through the Responsible Organization as described in B., following. The service provider will be unable to determine that such calls originated as 1+8XX+NXX-XXXX dialed calls unless the customer also orders the Automatic Number Identification (ANI) feature through the Company as described in 6.3.1, following.

800 DB Access Service provided from an equal access end office will be provisioned from the SSP switch as Feature Group D. Calls originating from end offices not equipped with equal access capabilities will be converted at the SSP switch to standard Feature Group D format.

When the customer orders 800 DB Access Service for the transmission of both voice and data traffic, the customer must order Clear Channel Capability (CCC) for provisioning of its data traffic.

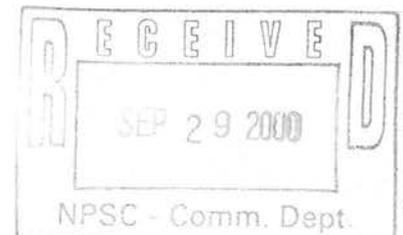

6. SWITCHED ACCESS SERVICE

6.2 PROVISION AND DESCRIPTION OF SWITCHED ACCESS SERVICE

6.2.5 800 DATA BASE ACCESS SERVICE

A. General Description (Cont'd)

The customer's 8XX Access Service voice or data traffic may be combined in the same trunk group arrangement with the customer's non-8XX Access Service voice or data traffic, or provisioned on a separate trunk group, unless prohibited by technical limitations.

Measurement of 800 DB Access Service usage shall be in accordance with the regulations set forth in 6.7.7, following, for trunkside Switched Access Service. Specifically, 800 DB Access Service originating usage, whether combined with non-8XX Access Service usage on trunk groups or provided using dedicated trunk groups, shall be measured in the same manner as specified for non-8XX Access Service usage over trunkside Switched Access Service.

The Company must be notified twenty-four (24) hours prior to any media stimulation. The Company maintains the right to apply protective controls, i.e., those actions such as call gapping, to ensure the provisioning of acceptable service to all telecommunications users of the Company's network services.

Application of rates for 800 DB Access Service shall be as set forth in 6.7.1, following.

B. Vertical Features

In addition to the basic carrier identification function, 800 DB Access Service subscribers may request vertical features through a Responsible Organization in accordance with the SMS/800 User Guide. Vertical features will be maintained within the Company's SCP when technically feasible. The POTS Translation feature is described in 1., following, and the Call Handling and Destination Features are described in 2., following.

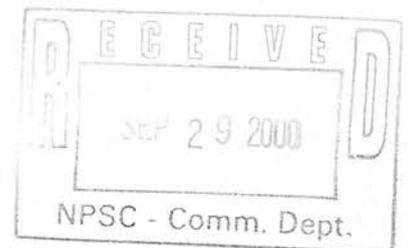

6. SWITCHED ACCESS SERVICE

6.2 PROVISION AND DESCRIPTION OF SWITCHED ACCESS SERVICE

6.2.5 800 DATA BASE ACCESS SERVICE

B. Vertical Features (Cont'd)

1. POTS Translation

The POTS Translation vertical feature provides the option of having the ten digit POTS number (i.e., NPA+NXX-XXXX) delivered instead of the 8XX dialed number (i.e., 8XX+NXX-XXXX) delivered to the service provider. If the POTS Translation feature is requested through the Responsible Organization, the service provider will be unable to determine that such calls originated as 1+8XX+NXX-XXXX dialed calls unless the service provider also orders, through the Company, the Automatic Number Identification (ANI) optional feature as described in 6.3.1, following. ANI information digit twenty-four (24) indicates that the call originated as an 8XX dialed call and is delivered when the ANI optional feature is ordered.

A POTS Translation Charge as described in 6.7.1, following, is assessed to the service provider for each 8XX call delivered.

2. Call Handling and Destination Features

Call Handling and Destination Features allow service subscribers variable routing options by specifying a single carrier, multiple carriers (Exchange and/or Interexchange Carriers), single termination or multiple terminations. Multiple terminations require the POTS Translation feature described in 1., preceding. The following variable routing options are available:

- Routing by Originating NPA+NXX-XXXX
- Time of Day
- Day of Week
- Specific Date
- Allocation by Percentage

Routing by originating NPA+NXX-XXXX, where technically feasible, allows a service subscriber to specify one or more multiple terminations with a single carrier and/or multiple carriers (Exchange and/or Interexchange Carriers) based on where a call originates.

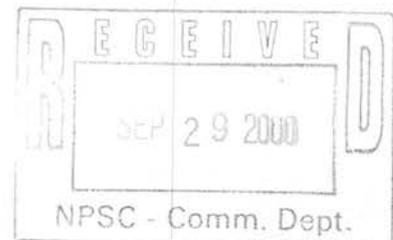

Qwest Corporation
Access Service
Catalog

SECTION 6
Page 64
Release 1

State of Nebraska
Notified: 9-29-2000

Effective: 9-29-2000

6. SWITCHED ACCESS SERVICE

6.2 PROVISION AND DESCRIPTION OF SWITCHED ACCESS SERVICE

6.2.5 800 DATA BASE ACCESS SERVICE

B.2. (Cont'd)

Time of Day/Day of Week allows a service subscriber to specify one or more multiple terminations with a single carrier and/or multiple carriers (Exchange and/or Interexchange Carriers) based on the time of day or day of week the call originates.

Specific Date allows the service subscriber to specify alternate service routes with the date the call originates. These calls can be routed to one or more multiple terminations, with a single carrier and/or multiple carriers (Exchange and/or Interexchange Carriers).

Allocation by Percentage allows the service subscriber to specify by percentage the calls to be allocated to multiple terminations and/or multiple carriers (Exchange and/or Interexchange Carriers).

A Call Handling and Destination Feature Query Charge as described in 6.7.1, following, is assessed to the service provider for each 8XX query to the SCP which utilizes one or more of the Call Handling and Destination Features.

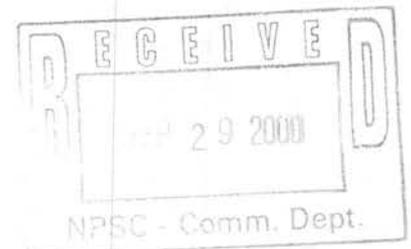

6. SWITCHED ACCESS SERVICE

6.2 PROVISION AND DESCRIPTION OF SWITCHED ACCESS SERVICE (Cont'd)

6.2.6 900 ACCESS SERVICE

900 Access Service is an originating service utilizing Trunkside Switched Access Service. The service provides a customer identification function based on the dialed NXX. When a 1+900+NXX-XXXX or 0+900+NXX-XXXX call is originated by the end user, the Company will determine, based on the NXX dialed, the customer to which the 900 call is to be routed. This six-digit routing function will be performed at suitably equipped end office and access tandem switches as determined by the Company.

The manner in which 900 Access Service is provisioned is dependent on the status of the end office which serves the end user customer who places a 900 call (i.e., equipped or not equipped with equal access capability) and/or the status of the customer (i.e., MTS/WATS provider or MTS/WATS-type provider). When 900 Access Service is provided from an end office equipped with equal access capability, all such service will be provisioned as Feature Group D or 900 Access Service (FGB-Like). When 900 Access Service is provided from an end office not equipped with equal access capability, such service will be provisioned as Feature Group C or 900 Access Service (FGB-Like) utilizing traditional signaling with answer supervision.

900 Access Service is available only as a LATA-wide service and must be provisioned to all offices within the LATA. 900 Access Service may be provisioned with 1+900+NXX-XXXX dialing capability or expanded to include 0+900+NXX-XXXX dialing capability. The Expanded 900 Option is not offered without 1+900 Access Service within a LATA and is available only with Feature Group D Service in suitably equipped Company End Offices.

Calls originating in a LATA in which the customer has not ordered 900 Access Service will be blocked. Only customers who order the Expanded 900 (i.e., 0+900+NXX-XXXX) Option will be able to receive 0+900 calls to NXX codes assigned to them. In addition, calls originating in a LATA for which 900 Access Service has been established will be blocked utilizing the blocking specifications as follows:

- 1+900+NXX-XXXX will be blocked from smart public access lines, 0+, 101XXXX, Inmate Service, Hotel/Motel Service (except those with customer-owned rating services).
- 0+900+NXX-XXXX will be blocked from 101XXXX and Inmate Service.

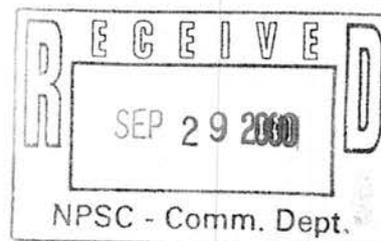

6. SWITCHED ACCESS SERVICE

6.2 PROVISION AND DESCRIPTION OF SWITCHED ACCESS SERVICE
6.2.6 900 ACCESS SERVICE (Cont'd)

At the option of the customer, 900 Access Service traffic may be collected at suitably equipped end offices and/or access tandems. However, the customer must collect 900 traffic at all access tandems within the LATA. Network constraints do not permit multiple tandem arrangements for routing of 900 traffic.

For 900 Access Service provisioned as Feature Group C or D, the customer may establish a separate trunk group or combine 900 traffic with other traffic types for access from suitably equipped end offices and access tandems. For 900 Access Service provisioned with traditional signaling and answer supervision, network limitations requires routing of 900 traffic from suitably equipped end offices and access tandems via a dedicated trunk group. Additionally, only 900 traffic will be routed over the dedicated trunk group.

Measurement of 900 Access Service usage shall be in accordance with the terms and conditions set forth in 6.7.7, following, for Feature Group C and D. Specifically, 900 Access Service originating usage shall be measured in the same manner as that specified for Feature Group C and D, whether provisioned separately (i.e., dedicated trunk group) or combined with other traffic types.

The Company must be notified 24 hours prior to any media stimulation. The Company maintains the right to apply protective controls, i.e., those actions such as call gapping, to ensure the provisioning of acceptable service to all telecommunications users of the Company's network services.

The rates and charges for 900 Access Service are described in 6.7.1, following.

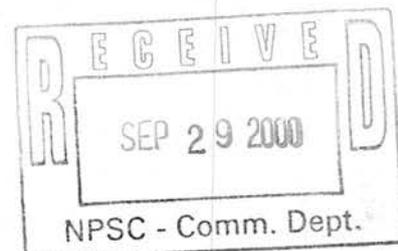

6. SWITCHED ACCESS SERVICE

**6.3 COMMON SWITCHING, TRANSPORT TERMINATION AND LINE TERMINATION
OPTIONAL FEATURES**

Following are descriptions of the various optional features that are available in lieu of, or in addition to, the standard features provided with the Switched Access Services. They are provided as either Common Switching or Transport Termination options.

6.3.1 COMMON SWITCHING OPTIONAL FEATURES

A. Call Denial on Line or Hunt Group

This option allows for the screening of terminating calls within the LATA, and for the completion only of calls to 411, 611, 911, 8XX, 555-1212, and a Company specified set of NXXs within the Company local exchange calling area of the dial tone office in which the arrangement is provided. All other "toll" calls are routed to a reorder tone or recorded announcement. This feature is provided in all Company electronic end offices and, where available, in electromechanical end offices. It is available with Feature Group A.

B. Service Code Denial on Line or Hunt Group

This option allows for the screening of terminating calls within the LATA, and for disallowing completion of calls to 0-, 555 and N11 (i.e., 411, 611 and 911). This feature is provided where available in all Company electronic end offices and electromechanical end offices. It is available with Feature Group A.

C. Hunt Group Arrangement

This option provides the ability to access sequentially one of two or more lineside connections in the originating direction, when the access code of the line group is dialed. This feature is provided in all Company end offices. It is available with Feature Group A. Resold and non-resold Lineside Access services cannot be mixed in the same hunt group arrangement.

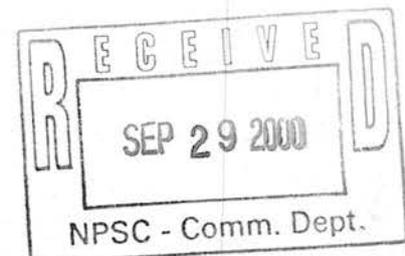

6. SWITCHED ACCESS SERVICE

**6.3 COMMON SWITCHING, TRANSPORT TERMINATION AND LINE TERMINATION
OPTIONAL FEATURES**

6.3.1 COMMON SWITCHING OPTIONAL FEATURES (Cont'd)

D. Uniform Call Distribution Arrangement

This option provides a type of multiline hunting arrangement which provides for an even distribution of calls among the available lines in a hunt group. Where available, this feature is provided in Company electronic end offices only. It is available with Feature Group A.

E. Nonhunting Number for Use with Hunt Group Arrangement or Uniform Call Distribution Arrangement

This option provides an arrangement for an individual line within a multiline hunt or uniform call distribution group that provides access to that line within the hunt or uniform call distribution group when it is idle or provides busy tone when it is busy, when the nonhunting number is dialed. Where available, this feature is provided in Company electronic end offices only. It is available with Feature Group A.

F. Automatic Number Identification (ANI)

1. This option provides the automatic transmission of a three, seven or ten digit number and information digits to the customer's premises for calls originating in the LATA, to identify the calling station. The three, seven or ten digit numbers will contain the following information: three digit, NPA only; seven digit, NXX-XXXX; ten digit, NPA+NXX-XXXX. The ANI feature is an end office software function which is associated on a call-by-call basis with (1) trunk groups routed directly between an end office and a customer's premises or, where technically feasible, with (2) trunk groups between an end office and a customer's premises through an access tandem.

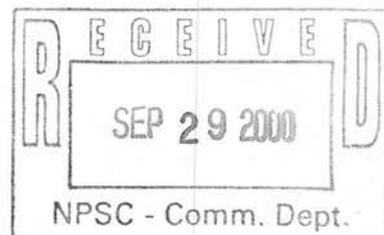

6. SWITCHED ACCESS SERVICE

**6.3 COMMON SWITCHING, TRANSPORT TERMINATION AND LINE TERMINATION
OPTIONAL FEATURES**

6.3.1 COMMON SWITCHING OPTIONAL FEATURES

F. Automatic Number Identification (ANI) (Cont'd)

2. The seven digit ANI telephone number is available with Feature Groups B (excluding 800 DB Access Service), where provided, and C. The seven digit ANI telephone number is available with 900 Access Service. With these Feature Groups and 900 Access, ANI will be provided only with DTT. ANI will be transmitted on all calls except those originating from multiparty lines, pay telephones using Feature Group B, when the end user has dialed 0- for operator assistance or when an ANI failure has occurred.
3. The ten digit ANI telephone number is only available with Feature Group D, including 800 DB Access Service and 900 Access Service provisioned as Feature Group D. The ten digit ANI telephone number consists of the Numbering Plan Area (NPA) plus the seven digit ANI telephone number. The ten digit ANI telephone number will be transmitted on all calls except those identified as multiparty line or when the end user has dialed 0- for operator assistance, in which case only the NPA will be transmitted (in addition to the information digit).
4. When 800 DB Access Service is ordered, the ten digit ANI telephone number will be transmitted on all calls except those where ANI cannot be provided as stated above or from end offices not equipped to provide ANI. In these instances, only the three digit NPA and the information digits described in the LATA Switching Systems Generic Requirements (LSSGR), Technical Reference FR-64, if applicable, will be transmitted.

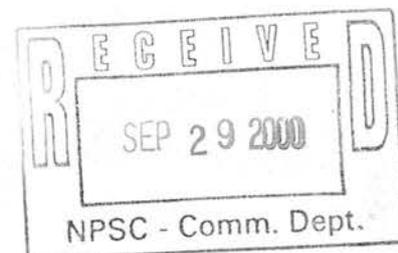

6. SWITCHED ACCESS SERVICE

**6.3 COMMON SWITCHING, TRANSPORT TERMINATION AND LINE TERMINATION
OPTIONAL FEATURES**

6.3.1 COMMON SWITCHING OPTIONAL FEATURES

F. Automatic Number Identification (ANI) (Cont'd)

5. With Feature Group C, ANI is provided from end offices at which Company recording for end user billing is not provided, or where it is not required. It is not provided from end offices for which the Company needs to forward ANI to its recording equipment.
6. Technical specifications are delineated in Technical Reference TR-NPL-000175 and TR-NPL-000258.
7. Where ANI cannot be provided, e.g., on calls from 4- and 8-party services, information digits will be provided to the customer.
8. Charge Number is the SS7 Out of Band Signaling equivalent of the ten digit ANI telephone number. Charge Number is the automatic transmission of the ten digit billing number of the calling station and the originating line information when a FGD trunk group is provisioned with SS7 Out of Band Signaling. Charge Number is provided when the customer requests the ANI optional feature on FGD trunk groups provisioned with SS7 Out of Band Signaling.
9. ANI information and Charge Number information are provided based on the following requirements:
 - a. The telephone number and billing information may be used for billing and collection, routing, screening, and completion of the originating subscriber's call or transaction, or for services directly related to the originating subscriber's call or transaction;
 - b. The ANI information shall not be reused or resold without first (i) notifying the originating subscriber and (ii) obtaining the affirmative consent of such subscriber for such reuse or resale; and
 - c. ANI information shall not be disclosed, except as permitted by a. and b., preceding, for any purpose other than (i) performing the services or transactions that are the subject of the originating subscriber's call, (ii) ensuring network performance security, and the effectiveness of call delivery, (iii) compiling, using and disclosing aggregate information, and (iv) complying with applicable law or legal process.

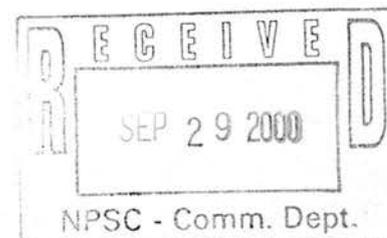

6. SWITCHED ACCESS SERVICE

**6.3 COMMON SWITCHING, TRANSPORT TERMINATION AND LINE TERMINATION
OPTIONAL FEATURES**

6.3.1 COMMON SWITCHING OPTIONAL FEATURES (Cont'd)

G. Up to 7 Digit Outpulsing to Customer

This option provides for the end office capability of providing up to 7 digits of the uniform access code 950-XXXX or 1 + 950-XXXX to the customer's premises. The customer can request that only some of the digits in the access code be forwarded. The access code digits would be provided to the customer's premises using multifrequency signaling, and transmission of the digits would precede the forwarding of ANI if that feature were provided. It is available with Feature Group B.

H. Cut-Through

This option allows end users of the customer to reach the customer's premises by using the end-of-dialing digit (#). This option provides for connection of the call to the premises of the customer indicated by the 101XXXX uniform access code upon receipt of the end-of-dialing digit (#). The Company will not record any other dialed digits for these calls. This option is available with Feature Group D.

I. Delay Dial Start-Pulsing Signaling

This option provides a method of indicating to the near-end trunk circuit readiness to accept address signaling information by the far-end trunk circuit. Delay dial is often referred to as an off-hook, on-hook signaling sequence. The delay dial signal is the off-hook interval and the start-pulsing signal is the on-hook interval. With integrity check, the calling office will not outpulse until a delay dial (off-hook) signal followed by a start-pulsing (on-hook) signal has been identified at the calling office. This option is available with Feature Group C.

J. Immediate Dial Pulse Address Signaling

This option provides for the forwarding of dial pulses from the Company end office to the customer without the need of a start-pulsing signal from the customer. It is available with Feature Group C.

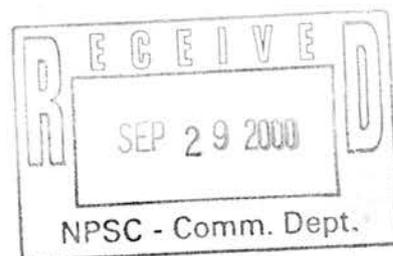

6. SWITCHED ACCESS SERVICE

6.3 COMMON SWITCHING, TRANSPORT TERMINATION AND LINE TERMINATION
OPTIONAL FEATURES

6.3.1 COMMON SWITCHING OPTIONAL FEATURES (Cont'd)

K. Dial Pulse Address Signaling

This trunkside option provides for the transmission of number information, e.g., called number, between the end office switching system and the customer's POT in either direction by means of direct current pulses. It is available with Feature Group C.

L. Service Class Routing

This option provides the capability of directing originating traffic from an end office to a trunk group to a customer-designated premises, based on the line class of service (e.g., coin, multiparty or hotel/motel), service prefix indicator (e.g., 00+, 00-, 0+, 0-, 1+, 01+, or 011+) or service access code (e.g., 8XX or 900 Service). A customer may direct all originating calls from an end office to a tandem trunk group to a single customer point of termination or multiple POTs when ordered with MPTS as referred to in 6.1.2.A.4.d., preceding, based on the line class of service, service prefix indicator or service access code. It is provided in suitably equipped end office or access tandem switches and is available with Feature Groups C and D.

M. Alternate Traffic Routing

The types of Alternate Traffic Routing available are described in 1. through 3., following. When Alternate Traffic Routing is added subsequent to initial service installation, service rearrangement charges are determined as set forth in 6.7.1, following.

1. Multiple Customer Premises Alternate Routing without MPTS

This option provides the capability of directing originating traffic from an end office (or appropriately equipped access tandem) to a trunk group (the "high usage" group) to a customer designated premises until that group is fully loaded, and then delivering additional originating traffic (the "overflowing" traffic) from the same end office or access tandem to a different trunk group (via one or more intermediate high usage groups) to a different customer designated premises until the originating traffic is directed to a final trunk group. The customer shall specify the last trunk CCS desired for the high usage group and each intermediate group(s). It is provided in suitably equipped end office or access tandem switches and is available with Feature Groups B, C and D.

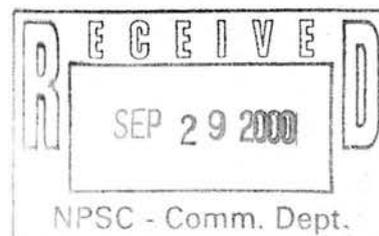

6. SWITCHED ACCESS SERVICE

**6.3 COMMON SWITCHING, TRANSPORT TERMINATION AND LINE TERMINATION
OPTIONAL FEATURES**

6.3.1 COMMON SWITCHING OPTIONAL FEATURES

M. Alternate Traffic Routing (Cont'd)

2. Multiple Customer Premises Alternate Routing with MPTS

This option provides the capability of directing originating traffic from an end office via a direct trunk group (the high usage group) and deliver originating traffic (the overflowing traffic) from the same end office through the tandem to a tandem routed trunk group (the "final" group) to a customer designated point of termination (POT). The tandem trunk group must be routed to the customer designated POT that is specified for the Tandem Sector of the originating end office. It is provided in suitably equipped end office or access tandem switches and is available with Feature Groups C and D.

Alternate traffic routing through the tandem to a multiple customer POT is not an option with MPTS. A customer may not overflow tandem traffic from one customer designated POT to a second customer designated POT.

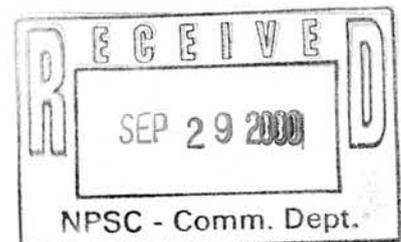

6. SWITCHED ACCESS SERVICE

**6.3 COMMON SWITCHING, TRANSPORT TERMINATION AND LINE TERMINATION
OPTIONAL FEATURES**

6.3.1 COMMON SWITCHING OPTIONAL FEATURES

M. (Cont'd)

3. End Office Alternate Routing When Ordered in Trunks

This option provides an alternate routing arrangement for customers who order in trunks and have access for a particular serving arrangement to an end office via two routes: one route via an access tandem and one direct route. The feature allows the customer's originating traffic from the end office to be offered first to the direct trunk group and then overflow to the access tandem group. It is provided in suitably equipped end offices and is available with Feature Groups B, C and D.

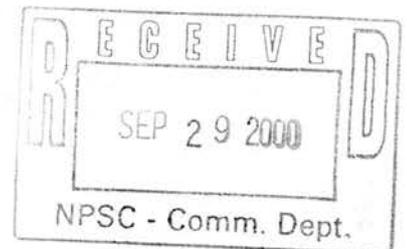

Qwest Corporation
Access Service
Catalog

SECTION 6

Page 75

Release 1

Effective: 9-29-2000

State of Nebraska
Notified: 9-29-2000

6. SWITCHED ACCESS SERVICE

**6.3 COMMON SWITCHING, TRANSPORT TERMINATION AND LINE TERMINATION
OPTIONAL FEATURES**

6.3.1 COMMON SWITCHING OPTIONAL FEATURES (Cont'd)

N. Trunk Access Limitation

This option provides for the routing of originating 900 service calls to a specified number of transmission paths in a trunk group, in order to limit (choke) the completion of such traffic to the customer. Calls to the designated service which could not be completed over the subset of transmission paths in the trunk group, i.e., the choked calls, would be routed to reorder tone. It is provided in all Company electronic end offices and where available in electromechanical end offices. It is available with Feature Groups C and D.

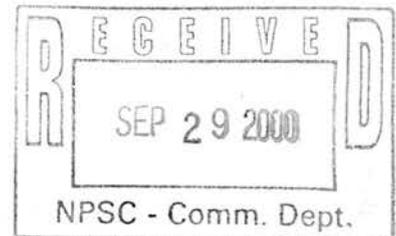

Qwest Corporation
Access Service
Catalog

SECTION 6

Page 76

Release 1

Effective: 9-29-2000

State of Nebraska
Notified: 9-29-2000

6. SWITCHED ACCESS SERVICE

**6.3 COMMON SWITCHING, TRANSPORT TERMINATION AND LINE TERMINATION
OPTIONAL FEATURES**

6.3.1 COMMON SWITCHING OPTIONAL FEATURES (Cont'd)

O. WATS Access Service (WATS)

At the option of the customer, WATS Access Service may be provided at Company designated end office switches, referred to as WATS Service Office(s) (WSO). WATS Access Service is provided in conjunction with Switched Access Service and a WATS Access Line. The WATS Access Line, as described in 5.2, preceding, is required to connect the WSO to the end user's premises.

WATS access lines are available for intrastate service as a Shared WATS access line or a dual jurisdiction WATS access line as set forth in 5.2, preceding.

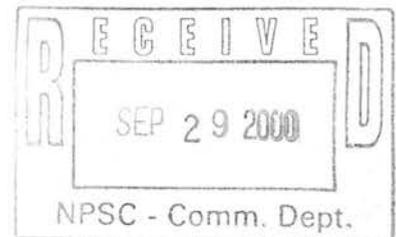

6. SWITCHED ACCESS SERVICE

6.3 COMMON SWITCHING, TRANSPORT TERMINATION AND LINE TERMINATION
OPTIONAL FEATURES

6.3.1 COMMON SWITCHING OPTIONAL FEATURES (Cont'd)

P. InterLATA Toll Denial

This option provides for the screening of all calls on terminating FGA lines and for the completion only of calls to 411, 611, 911, 8XX, 555-1212, Local Information Delivery Services and 0+ or 1+ intraLATA. All interLATA calls, 950-XXXX and 101XXXX are routed to a recorded announcement.

This feature is provided in all Company end offices where technically available. It is available with Feature Group A. This feature does not affect calls placed on originating FGA lines.

Customers requesting FGA line(s) without the InterLATA Toll Denial Option will be responsible for interLATA calls recorded on FGA line(s).

Q. SWITCHNET 56 Service Switching Capability

This option allows for a connection between the customer's premises and a suitably equipped end user's premises, utilizing end office and/or access tandem switching capable of transmitting 56 kbit/s digital data. SWITCHNET 56 Service is available with Feature Group D from suitably equipped electronic end offices and/or access tandems. When SWITCHNET 56 Service is ordered in conjunction with FGD, it requires the use of a separate trunk group equipped with Interface Group 6. When SWITCHNET 56 is used with FGD, the standard FGD dialing pattern is used.

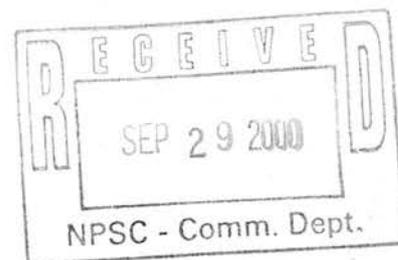

6. SWITCHED ACCESS SERVICE

**6.3 COMMON SWITCHING, TRANSPORT TERMINATION AND LINE TERMINATION
OPTIONAL FEATURES**

6.3.1 COMMON SWITCHING OPTIONAL FEATURES (Cont'd)

R. Signaling System Seven (SS7) Out of Band Signaling

This option provides SS7 Out of Band Signaling on a FGD transmission path group. This option provides the customer the ability to use Out of Band Signaling to set up trunks on a per call basis. CCSAC Service as described in 15.2.1, following, is required between the customer's Signaling Point of Interface (SPOI) and the Company's Signal Transfer Point (STP) for SS7 Out of Band Signaling in each LATA.

SS7 Out of Band Signaling provides the automatic transmission of the following parameters:

- Access Transport Parameter (ATP) provides automatic transmission of information from the originating calling location through the Common Channel Signaling Network. Information supplied using ATP may consist of one or more of the following: Called Party Subaddress; Calling Party Subaddress; High and Low Layer Compatibility and Compatibility Checking by the called party's equipment. ATP is available when Feature Group D Service is equipped with SS7 Out of Band Signaling and Clear Channel Capability.
- Calling Party Number (CPN) is the automatic transmission of the calling party's ten digit telephone number to the customer's premises for calls originating in the LATA. The ten digit number consists of the Numbering Plan Area (NPA) plus the seven digit telephone number. The Company will automatically transmit CPN with SS7 Out of Band Signaling in those offices suitably equipped with the software that allows customers to elect to block their CPN information from being displayed to the called party. This software allows the customer to block their CPN on a per call basis, and transmits a "privacy indicator" as part of the CPN information.
- Charge Number is the SS7 Out of Band Signaling equivalent of the ten-digit ANI telephone number. Charge Number is the automatic transmission of the ten-digit billing number of the calling station and the originating line information when a FGD trunk group is provisioned with SS7 Out of Band Signaling. Charge Number is provided when the customer requests the ANI optional feature trunk groups provisioned with SS7 Out of Band Signaling.

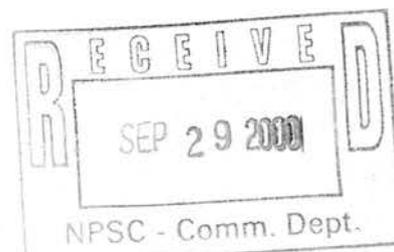

6. SWITCHED ACCESS SERVICE

**6.3 COMMON SWITCHING, TRANSPORT TERMINATION AND LINE TERMINATION
OPTIONAL FEATURES**

6.3.1 COMMON SWITCHING OPTIONAL FEATURES

R. Signaling System Seven (SS7) Out of Band Signaling (Cont'd)

Charge Number information is provided based on the following requirements:

- the telephone number and billing information may be used for billing and collection, routing, screening, and completion of the originating subscriber's call or transaction, or for services directly related to the originating subscriber's call or transaction;
 - the Charge Number information shall not be reused or resold without first (i) notifying the originating subscriber and (ii) obtaining the affirmative consent of such subscriber for such reuse or resale; and
 - Charge Number information shall not be disclosed, except as permitted by the preceding two paragraphs, for any purpose other than (i) performing the services or transactions that are the subject of the originating subscriber's call, (ii) ensuring network performance security, and the effectiveness of call delivery, (iii) compiling, using and disclosing aggregate information, and (iv) complying with applicable law or legal process.
- Carrier Selection Parameters (CSP) is the automatic transmission of a signaling indicator which signifies to the customer that the call being processed originated from a presubscribed line or by dialing the 101XXXX code.

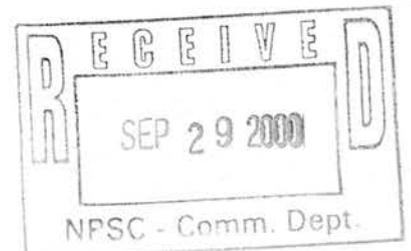

6. SWITCHED ACCESS SERVICE

**6.3 COMMON SWITCHING, TRANSPORT TERMINATION AND LINE TERMINATION
OPTIONAL FEATURES**

6.3.1 COMMON SWITCHING OPTIONAL FEATURES

R. Signaling System Seven (SS7) Out of Band Signaling (Cont'd)

The technical specifications for ATP, CPN and CSP parameters are described in Technical References GR-905-CORE, GR-394-CORE and in Qwest Corporation Technical Reference 77342.

When rearranging signaling to SS7 Out of Band Signaling, a SS7 Out of Band Signaling Rearrangement Charge applies as described in 6.7.1, following.

S. Clear Channel Capability

Clear Channel Capability (CCC) is the ability to send any combination of ones (marks) and zeros (spaces) in the 192 information bits of each frame. This permits 24 DS0-64 kbps services or 1.536 Mbps of customer information on the 1.544 Mbps line rate.

Bipolar Eight Zero Substitution (B8ZS) line code conformity is required. The B8ZS line code is described in Technical Reference GR-334-CORE.

CCC is available on FGD Service when the trunkside service is equipped with SS7 Out of Band Signaling and Interface Group 6 or 9 on separate trunk(s) in suitably equipped digital Company end offices or access tandems. CCC may be utilized in conjunction with 800 DB Access Service for transmission of 8XX data traffic where technically feasible.

CCC equipped trunkside service requires a specific traffic type (i.e., CCC Originating and/or CCC Terminating) as set forth in 6.1.1, preceding.

The description and application of rates and charges for CCC are set forth in 6.7.1, following.

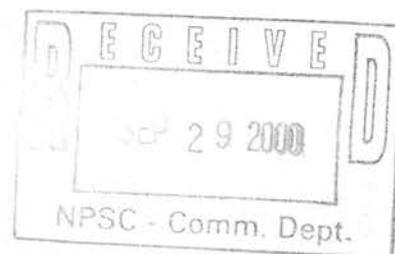

6. SWITCHED ACCESS SERVICE

**6.3 COMMON SWITCHING, TRANSPORT TERMINATION AND LINE TERMINATION
OPTIONAL FEATURES (Cont'd)**

6.3.2 TRANSPORT TERMINATION OPTIONAL FEATURES

A. Operator Trunk-Coin, Non-Coin, or Combined Coin and Non-Coin

This option may be ordered to provide coin, non-coin, or combined coin and non-coin operation. It is available only with Feature Group C and D. Non-coin trunks are provided in Company electronic and electromechanical end offices. Coin and combined coin and non-coin trunks are provided only at Company electronic end offices and other Company end offices where equipment is available. This option is provided as a trunk type of Transport Termination and is not available with SS7 Out of Band Signaling.

1. Coin

This arrangement provides for initial coin return control and routing of 00+, 00-, 0+, 0-, 1+, 01+ or 011+ prefixed originating coin calls requiring operator assistance to the customer's premises. Because operator assisted coin calling traffic is routed over a trunk group dedicated to operator assisted calls, this arrangement is only provided in association with the Service Class Routing option.

The operator assistance coin calling arrangement is also normally ordered by the customer in conjunction with the ANI optional feature, since the preponderance of trunk groups equipped with this arrangement will be terminated in the customer's operator service positions, rather than in the customer's manual cord boards.

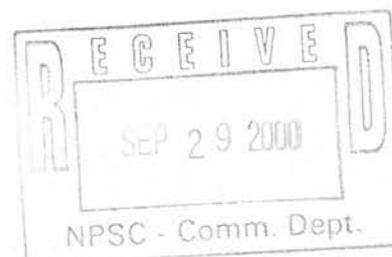

NOTICE

THE INFORMATION CONTAINED IN THIS DOCUMENT IS SUBJECT TO CHANGE.
NE2000-054

6. SWITCHED ACCESS SERVICE

**6.3 COMMON SWITCHING, TRANSPORT TERMINATION AND LINE TERMINATION
OPTIONAL FEATURES**

6.3.2 TRANSPORT TERMINATION OPTIONAL FEATURES

A. Operator Trunk-Coin, Non-Coin, or Combined Coin and Non-Coin (Cont'd)

2. Non-Coin

This arrangement provides for the routing of 00+, 00-, 0+, 0-, 1+, 01+ or 011+ prefixed originating non-coin calls requiring operator assistance to the customer's premises. Because operator assisted non-coin calling traffic is routed over a trunk group dedicated to operator assisted calls, this arrangement is only provided in association with the Service Class Routing option.

The operator assistance non-coin calling arrangement is also normally ordered by the customer in conjunction with the ANI optional feature, since the preponderance of trunk groups equipped with this arrangement will be terminated in the customer's operator service positions, rather than in the customer's manual cord boards. When so equipped, the ANI feature provides for the forwarding of information digits which identify that the call has originated from a hotel or motel, and whether room number identification is required, or that special screening is required, e.g., for coinless public stations, dormitory or inmate stations, or other screening arrangements agreed to between the customer and the Company.

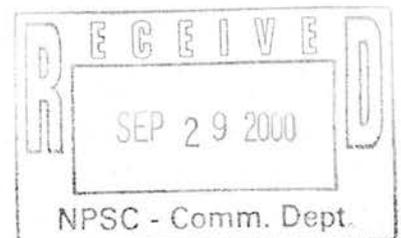

6. SWITCHED ACCESS SERVICE

**6.3 COMMON SWITCHING, TRANSPORT TERMINATION AND LINE TERMINATION
OPTIONAL FEATURES**

6.3.2 TRANSPORT TERMINATION OPTIONAL FEATURES

A. Operator Trunk-Coin, Non-Coin, or Combined Coin and Non-Coin (Cont'd)

3. Combined Coin and Non-Coin

This arrangement provides for initial coin return control and routing of 00+, 00-, 0+, 0-, 1+, 01+ or 011+ prefixed originating operator assisted coin and non-coin calls requiring operator assistance to the customer's premises. Because operator assisted coin and non-coin calling traffic is routed over a trunk group dedicated to operator assisted calls, this arrangement is only provided in association with the Service Class Routing option.

This arrangement is normally ordered by the customer in conjunction with the ANI optional feature, since the preponderance of trunk groups equipped with this arrangement will be terminated in the customer's operator services systems, rather than in the customer's manual cord boards. When so equipped, the ANI optional features provide for the forwarding of information digits which identify that the call has originated from a hotel or motel, and whether room number identification is required, or that special screening is required, e.g., for coinless pay telephones, dormitory or inmate stations, or other screening arrangements agreed to between the customer and the Company.

B. Operator Trunk - Full Feature

This option provides the operator functions available in the end office to the customer's operator. These functions are (1) Operator Released, (2) Operator Attached, (3) Coin Collect, (4) Coin Return, and (5) Ringback. It is available with Feature Group D and is provided as a trunk type of Transport Termination. This option is not available with SS7 Out of Band Signaling.

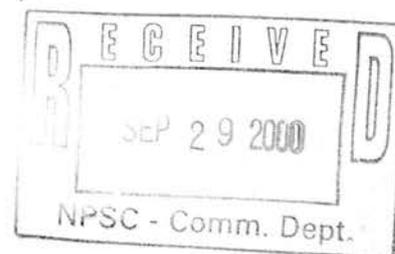

NOTICE

THE INFORMATION CONTAINED IN THIS DOCUMENT IS SUBJECT TO CHANGE.

6. SWITCHED ACCESS SERVICE

6.4 TRANSMISSION SPECIFICATIONS

- A. Each Switched Access Service transmission path is provided with standard transmission parameter limits. The standard for a particular transmission path is dependent on the Switched Access Service, the Interface Group and whether the service is directly routed to an end office or routed to the access tandem. The available transmission parameter limits are set forth in Technical Reference GR-334-CORE and associated addenda. Data transmission parameter limits are also provided with each Switched Access Service transmission path. The Company will, upon notification by the customer that the data parameters set forth in Technical Reference GR-334-CORE and associated addenda are not being met, conduct tests independently or in cooperation with the customer, and take any necessary action to ensure that the data parameters are met.
- B. The Company will maintain existing transmission parameter limits on functioning service configurations installed prior to the effective date of this Catalog, except that service configurations having performance specifications exceeding the standards listed in this provision will be maintained at performance levels specified in Technical Reference GR-334-CORE and associated addenda.
- C. The transmission parameter limits contained in this section are Immediate Action Limits (IAL). Acceptance Limits (AL) are set forth in Technical Reference GR-334-CORE. This technical reference also provides the basis for determining Switched Access Service maintenance limits.
- D. Transmission specifications for SS7 Out of Band Signaling are delineated in Technical Reference GR-394-CORE, GR-905-CORE and in Qwest Corporation Technical Reference 77342.
- E. Transmission specifications and error performance parameters for DS1 level digital transmission on FGD Service equipped with Clear Channel Capability are delineated in Technical Reference GR-334-CORE.

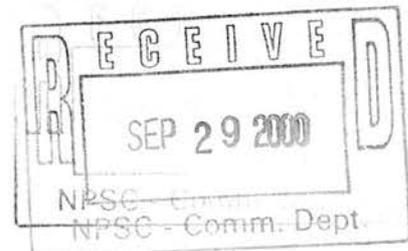

6. SWITCHED ACCESS SERVICE

6.5 OBLIGATIONS OF THE COMPANY

In addition to the obligations of the Company set forth in Section 2, preceding, the Company has certain other obligations pertaining only to the provision of Switched Access Service. These obligations are as follows:

6.5.1 NETWORK MANAGEMENT

The Company will administer its network to ensure the provision of acceptable service levels to all telecommunications users of the Company's network services.

Generally, service levels are considered acceptable only when both end users and customers are able to establish connections with little or no delay encountered within the Company network. The Company maintains the right to apply protective controls, i.e., those actions, such as call gapping, which selectively cancel the completion of traffic, over any traffic carried over its network, including those associated with a customer's Switched Access Service. Generally, such protective measures would only be taken as a result of occurrences such as failure or overload of Company or customer facilities, natural disasters, mass calling or national security demands. In the event that the protective controls applied by the Company result in the complete loss of service by the customer, the customer will be granted a Credit Allowance for Service Interruption as set forth in 2.4.4.B., preceding.

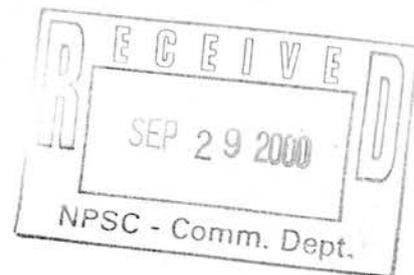

6. SWITCHED ACCESS SERVICE

6.5 OBLIGATIONS OF THE COMPANY (Cont'd)

6.5.2 DESIGN AND TRAFFIC ROUTING OF SWITCHED ACCESS SERVICE

When ordering Switched Access Service, the customer shall specify on the order for service the Entrance Facility, direct routing or tandem routing, the number of lines or trunks and the desired directionality (i.e., one-way, two-way). When the customer orders facilities, routing, directionality or optional features different from that determined to be available by the Company, the Company will work cooperatively with the customer in determining an acceptable configuration based on available facilities, equipment and the Company routing plans. Rates and charges for Switched Transport, as set forth in 6.8, following, will be applied based on the transport provisioned at the time the order is completed. For example, if direct routing to the end office is requested but facilities are not available and the customer accepts tandem routing, the rates for the tandem routing configuration shall apply until such time that direct routing to the end office is provided.

6.5.3 DS1 RECORDS ASSIGNMENT

When the customer initially orders a DS3 EF with DS3 DTT facilities to a Company Hub, access tandem or end office, the Company will provide to the customer, the appropriate DS1 facility record necessary for the customer to identify circuit facility assignment (CFA). On subsequent orders utilizing existing DS3 Entrance Facilities or DS3 DTT facilities, the Company will assign the DS1 facility to the DS3 Entrance Facility or DS3 DTT facility as directed by the customer's order.

6.5.4 MULTIPLEXING

The Company will provide multiplexing equipment at a location determined by the Company as part of its overall network design when the conditions exist as set forth in 6.1.2, preceding.

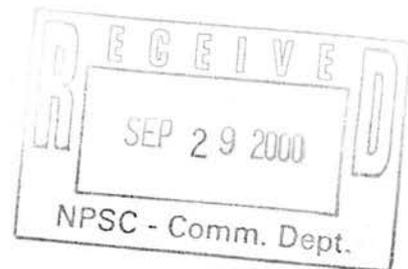

6. SWITCHED ACCESS SERVICE

6.5 OBLIGATIONS OF THE COMPANY (Cont'd)

6.5.5 PROVISION OF SERVICE PERFORMANCE DATA

Subject to availability, end-to-end service performance data available to the Company through its own service evaluation routines, may also be made available to the customer based on previously arranged intervals and format. These data provide information on overall end-to-end call completion and non-completion performance, e.g., customer equipment blockage, failure results and transmission performance. These data do not include service performance data which are provided under other Catalog sections, e.g., testing service results. If data are to be provided in other than paper format, the charges for such exchange will be determined on an individual case basis.

6.5.6 TRUNK GROUP MEASUREMENT REPORTS

Subject to availability, the Company will make available trunk group data, in the form of usage in CCS, peg count and overflow, to the customer based on previously agreed to intervals. Trunk group measurement reports will be available for Switched Access Service and WATS Access Service at no charge to the customer.

6.5.7 DETERMINATION OF NUMBER OF TRANSMISSION PATHS

DS1 and DS3 Entrance Facilities and DTT facilities requested by the customer are solely transport facilities capable of 24 and 672 channels, respectively, and do not reflect the actual switching capacity in the SWC, end office, access tandem, or Company Hub. The actual number of transmission paths provided will be based on the customer's line or trunk request. Subsequent assignment will be based on switching equipment available.

For Lineside or Trunkside Switched Access Service which is ordered on a per-line or per-trunk basis, the customer specifies the number of transmission paths in the order for service.

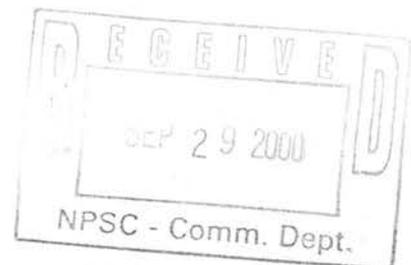

NOTICE

THE INFORMATION CONTAINED IN THIS DOCUMENT IS SUBJECT TO CHANGE.
NE2000-054

6. SWITCHED ACCESS SERVICE

6.5 OBLIGATIONS OF THE COMPANY (Cont'd)

6.5.8 DETERMINATION OF NUMBER OF END OFFICE TRANSPORT TERMINATIONS

For analog entry switches, a termination will be provided for each Feature Group line or trunk requested. For digital entry switches, an equivalent termination will be provided for each Feature Group line or trunk requested.

6.5.9 DESIGN BLOCKING PROBABILITY

The Company will design and monitor the facilities used in the provision of Switched Access Services to meet the blocking probability criteria as set forth in A. through E., following.

- A. For Feature Group A and B, no design blocking criteria apply.
- B. For Feature Group C, the design blocking objective will be no greater than one percent (.01) between the point of termination at the customer's premises and the first point of switching when traffic is directly routed without an alternate route. Standard traffic engineering methods will be used by the Company to determine the number of transmission paths required to achieve this level of blocking.
- C. For Feature Group D, the design blocking objective for the final group will be no greater than one percent (.01) between the point of termination at the customer's premises and the end office switch, whether the traffic is directly routed without an alternate route or routed via an access tandem. Standard traffic engineering methods as set forth in reference document Special Report SR-TAP-000191 Trunk Traffic Engineering Concepts and Applications will be used by the Company to determine the number of transmission paths required to achieve this level of blocking.
- D. The design blocking criteria for 800 DB Access Service and/or 900 Access Service will be equivalent to the design blocking criteria of the Feature Group(s) that they are provisioned as except under media stimulation when use of protective controls may be utilized to ensure the provisioning of acceptable service levels to all telecommunication users of the Company's network services.

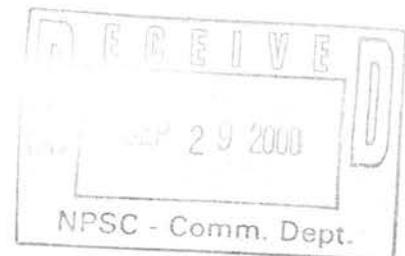

6. SWITCHED ACCESS SERVICE

6.5 OBLIGATIONS OF THE COMPANY

6.5.9 DESIGN BLOCKING PROBABILITY (Cont'd)

E. The Company will perform routine measurement functions for the trunks ordered in accordance with Company design blocking criteria to assure that an adequate number of trunks are in service. The Company will recommend that additional trunks be ordered by the customer when additional trunks are required to reduce the measured blocking to the designed blocking level. Where design blocking criteria apply, the design blocking objective is assumed to have been met if the routine measurements show that the measured blocking does not exceed the thresholds listed in the following tables.

1. For transmission paths carrying only first routed traffic directly between an end office and a customer's premises without an alternate route, and for paths carrying only overflow traffic, the measured blocking thresholds are as follows:

NUMBER OF TRUNKS PER TRUNK GROUP	MEASURED BLOCKING THRESHOLDS IN THE TIME CONSISTENT BUSY HOUR FOR THE NUMBER OF MEASUREMENTS PER TRUNK GROUP			
	15-20	11-14	7-10	3-6
	MEASURE- MENTS	MEASURE- MENTS	MEASURE- MENTS	MEASURE- MENTS
2	.070	.080	.090	.140
3	.050	.060	.070	.090
4	.050	.060	.070	.080
5-6	.040	.050	.060	.070
7 or more	.030	.035	.040	.060

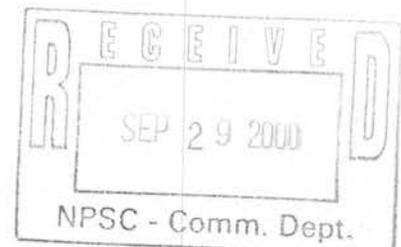

**Qwest Corporation
Access Service
Catalog**

SECTION 6
Page 90
Release 1
Effective: 9-29-2000

State of Nebraska
Notified: 9-29-2000

6. SWITCHED ACCESS SERVICE

6.5 OBLIGATIONS OF THE COMPANY
6.5.9 DESIGN BLOCKING PROBABILITY

E. (Cont'd)

2. For transmission paths carrying first-routed traffic between an end office and a customer's premises via an access tandem, the measured blocking thresholds are as follows:

NUMBER OF TRANSMISSION PATHS PER TRUNK GROUP	MEASURED BLOCKING THRESHOLDS IN THE TIME CONSISTENT BUSY HOUR FOR THE NUMBER OF MEASUREMENTS PER TRUNK GROUP			
	15-20 MEASURE- MENTS	11-14 MEASURE- MENTS	7-10 MEASURE- MENTS	3-6 MEASURE- MENTS
2	.045	.055	.060	.095
3	.035	.040	.045	.060
4	.035	.040	.045	.055
5-6	.025	.035	.040	.045
7 or more	.020	.025	.030	.040

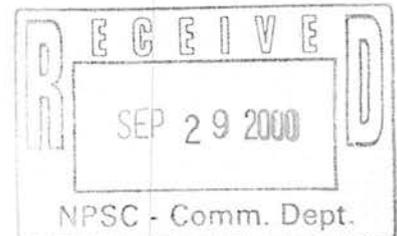

6. SWITCHED ACCESS SERVICE

6.5 OBLIGATIONS OF THE COMPANY (Cont'd)

6.5.10 END USER LINE AND USAGE INFORMATION DATA

A. General

The Company will provide to Interexchange Carriers (ICs), upon request, historical and projected information pertaining to the number of end user lines and average use per line. Such historical and projected information shall be limited to that information which the Company uses in the course of performing its normal business operations. Additionally, the Company will make updated information available on a semi-annual basis.

B. Information Content and Format

The historical and projected data will be provided on a per end office basis and will consist of the following information:

- Number of residential lines
- Number of business lines
- Average use per line

Unless otherwise requested, the data will be provided in machine-readable format.

C. Availability of Data

The Company will update the data semi-annually and provide the data to the requesting IC within 30 days of the receipt of request.

D. Charges for Data

The charge to the IC for such data will be developed on an individual case basis and will include only those incremental costs incurred by the Company in responding to the individual data request. Incremental costs include, but are not limited to, costs associated with the provision of data in a non-standard format as well as costs associated with responding to other individualized treatment requested by the IC.

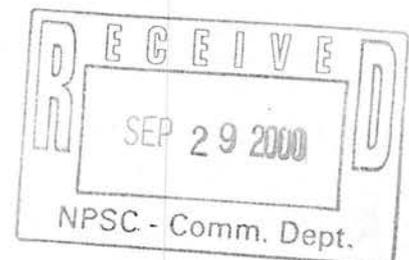

6. SWITCHED ACCESS SERVICE

6.6 OBLIGATIONS OF THE CUSTOMER

In addition to the obligations of the customer set forth in Section 2, preceding, the customer has certain specific obligations pertaining to the use of Switched Access Service. These obligations are as follows:

6.6.1 ORDERING REQUIREMENTS

When ordering Switched Access Service, the customer shall specify on the order for service, the type and number of Entrance Facilities to terminate at the customer's SWC, the desired interoffice transport, (direct routing or tandem routing), the number of lines and/or trunks to be provisioned at an end office or access tandem and the desired directionality.

6.6.2 REPORT REQUIREMENTS

Customers are responsible for providing the following reports to the Company, when applicable.

A. Jurisdictional Reports

When a customer orders Switched Access Service for both interstate and intrastate use, the customer is responsible for providing reports as set forth in 2.3.10, preceding. Charges will be apportioned in accordance with those reports. The method to be used for determining the intrastate charges is set forth in 2.3.12, preceding.

B. Code Screening Reports

When a customer orders Service Class Routing or trunk access limitation arrangements, it must report the number of trunks and/or the appropriate codes to be instituted in each end office or access tandem switch, for each of the arrangements ordered.

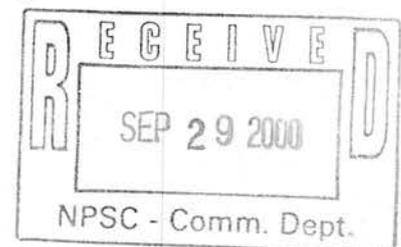

6. SWITCHED ACCESS SERVICE

6.6 OBLIGATIONS OF THE CUSTOMER

6.6.2 REPORT REQUIREMENTS (Cont'd)

C. 900 NXX Code Reports

When ordering 900 Access Service, the customer must report the appropriate NXX code(s) to be instituted in each Company office at which the customer identification function is performed. The report must be updated by the customer each time a change is scheduled to occur (i.e., when a new code is to be added or an existing code is to be deleted). Such updated reports shall be provided at least 60 calendar days prior to the effective date of the change in order to allow the Company sufficient time to implement the change.

D. Multiple POTs Tandem Sectorization Reports

When ordering MPTS the customer must report the customer designated POTs for all subtending end offices served by an access tandem. The report shall be provided at the same time the access order is placed.

6.6.3 SUPERVISORY SIGNALING

The customer's facilities shall provide the necessary off-hook and on-hook answer and disconnect supervision.

6.6.4 TRUNK GROUP MEASUREMENTS REPORTS

With the agreement of the customer, trunk group data in the form of usage in CCS, peg count and overflow for its end of all access trunk groups, where technologically feasible, will be made available to the Company. These data will be used to monitor trunk group utilization and service performance and will be based on previously arranged intervals and format.

6.6.5 DESIGN OF SWITCHED ACCESS SERVICES

When a customer orders Switched Access Service on a per facility and/or per-trunk basis, it is the customer's responsibility to assure that sufficient access services have been ordered to handle its traffic.

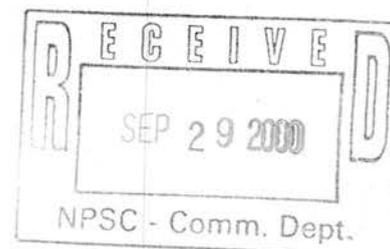

6. SWITCHED ACCESS SERVICE

6.7 RATE TERMS AND CONDITIONS

This section contains the specific terms and conditions governing the rates and charges that apply for Switched Access Service.

6.7.1 DESCRIPTION AND APPLICATION OF RATES AND CHARGES

There are three types of rates and charges that apply to Switched Access Service. These are monthly recurring rates, usage rates and nonrecurring charges. These rates and charges are applied differently to the various rate elements as set forth in C. and D., following.

A. Monthly Rates

Monthly rates are flat recurring rates that apply each month or fraction thereof that a specific rate element is provided. For billing purposes, each month is considered to have 30 days.

B. Usage Rates

Usage rates are rates that apply only when a specific rate element is used. These are applied on a per-access minute, a per-call, or per query basis. Usage rates are accumulated over a monthly period.

C. Nonrecurring Charges

Nonrecurring charges are one-time charges that apply for specific work activity (i.e., installation or change to an existing service). The types of nonrecurring charges that apply for Switched Access Service are: installation of service, installation of optional features and service rearrangements. These charges are set forth in 6.8, following.

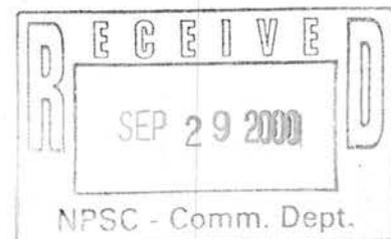

6. SWITCHED ACCESS SERVICE

6.7 RATE TERMS AND CONDITIONS

6.7.1 DESCRIPTION AND APPLICATION OF RATES AND CHARGES

C. Nonrecurring Charges (Cont'd)

1. Installation of Service

Nonrecurring charges apply for the installation of the individual Feature Group line or trunk.

a. For Switched Access Service which is ordered on a per-line or -trunk basis, the nonrecurring charge is applied per line or per trunk. Nonrecurring charges are assessed dependent on the Interface Group ordered for terminating Switched Transport at the customer's POT. Each Interface Group provides a specified premises interface as set forth in 6.1.2, preceding. Each Interface Group (i.e., 1, 2, 6, 9) is assigned to an Interface Group Category for the application of nonrecurring charges based on the "first" and "each additional" line or trunk application per Access Order. If a customer orders multiple lines or trunks on the same Access Order, the first line or trunk is assessed the "first" installation charge and each additional line or trunk is assessed the "each additional" installation charge per Interface Group Category (i.e., 1 and 2, 6 or 9), per Access Order.

b. Nonrecurring charges for FGB or FGD Switched Access Service include one Carrier Identification Code (CIC) on an initial Access Order. The CIC is a uniform numeric code that identifies the customer associated with the Switched Access Service. The customer of the initial CIC is the customer of record for the Switched Access Service. When a customer requests two or more CICs on an initial Access Order, each additional CIC (i.e., two or more) is considered to be a service rearrangement as set forth in 3., following.

2. Installation of Optional Features

Nonrecurring charges apply for the installation of some of the optional features available with Switched Access Service. The charge may apply whether the feature is installed coincident with the initial installation of service or at any time subsequent to the initial installation of service.

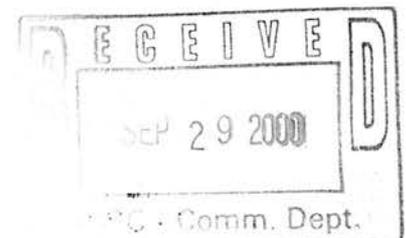

Qwest Corporation
Access Service
Catalog

SECTION 6

Page 96

Release 1

Effective: 9-29-2000

State of Nebraska
Notified: 9-29-2000

6. SWITCHED ACCESS SERVICE

6.7 RATE TERMS AND CONDITIONS

6.7.1 DESCRIPTION AND APPLICATION OF RATES AND CHARGES

C. Nonrecurring Charges (Cont'd)

3. Service Rearrangements

Service rearrangements are changes to existing services installed which do not result in either a change in the minimum period requirements as set forth in 5.2.5, preceding, or a change in the physical location of the POT at a customer's premises or a customer's end user's premises. Changes which result in the establishment of new minimum period obligations are treated as disconnects and starts. Changes in the physical location of the POT are treated as moves and are described and charged for as set forth in 6.7.6, following.

The charge to the customer for the service rearrangement is dependent on whether the change is administrative only in nature or involves an actual technical and/or physical change to the service.

Administrative changes will be made without charge(s) to the customer. Administrative changes are as follows:

- Change of customer name (i.e., the customer of record does not change but rather the customer of record changes its name - XYZ Telephone Company to XYZ Communications)
- Change of customer name as the result of a transfer of use of service as set forth in 2.1.2, preceding,
- Change of customer or customer's end user's premises address when the change of address is not a result of a physical relocation of equipment,
- Change in billing data (name, address, or contact name or telephone number),
- Change of agency authorization,
- Change of customer circuit identification,
- Change of billing account number,
- Change of customer test line number,
- Change of customer or customer's end user's contact name or telephone number,
- Change of jurisdiction

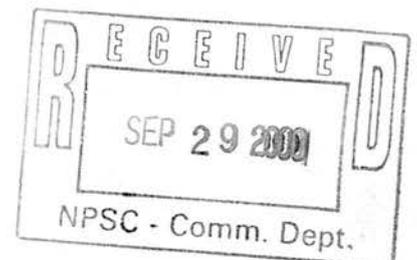

Qwest Corporation
Access Service
Catalog

SECTION 6
Page 97
Release 1
Effective: 9-29-2000

State of Nebraska
Notified: 9-29-2000

6. SWITCHED ACCESS SERVICE

6.7 RATE TERMS AND CONDITIONS

6.7.1 DESCRIPTION AND APPLICATION OF RATES AND CHARGES

C.3. (Cont'd)

All other service rearrangements will be charged for as follows:

- a. If the change involves the addition of or a modification to an optional feature which has a separate nonrecurring charge, that nonrecurring charge will apply.
- b. If, due to technical limitations of the Company, a customer could not combine its 800 DB Access Service and/or 900 Access Service traffic with its other trunkside Switched Access Services, no charge shall apply to combine these trunk groups when it becomes technically possible.
- c. If, due to an office replacement, a customer requests conversion from one-way to two-way trunks, and the request is made six months in advance of the office replacement due date, the nonrecurring charges will not apply.
- d. For all other changes, including the addition of, or modifications to, optional features without separate nonrecurring charges, a charge equal to one-half the Switched Transport per line or per trunk nonrecurring (i.e., installation) charge will apply. This one-half nonrecurring charge is assessed the "first" installation charge for the first line or trunk and each additional line or trunk is assessed the "each additional" installation charge per appropriate Interface Group category, per Access Order. If two or more optional features and changes are ordered on the same Access Order, the optional feature or change requiring the lowest level of work activity will apply. A maximum one-half nonrecurring charge will apply per Access Order for service rearrangements.
- e. If a feature is not required on each line or trunk, but rather for an entire hunt or trunk group, end office or an access tandem switch, only one such charge will apply (i.e., it will not apply per line or trunk). This one-half nonrecurring charge is assessed the "first" installation charge for the first hunt group, trunk group, end office or access tandem switch and each additional hunt group, trunk group, end office or access tandem switch is assessed the "each additional" installation charge per appropriate Interface Group category, per Access Order. Nonrecurring charges for service rearrangements are specified in 6.8, following.

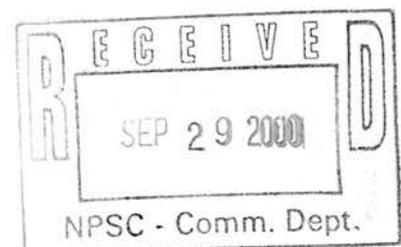

Qwest Corporation
Access Service
Catalog

SECTION 6

Page 98

Release 1

Effective: 9-29-2000

State of Nebraska
Notified: 9-29-2000

6. SWITCHED ACCESS SERVICE

6.7 RATE TERMS AND CONDITIONS

6.7.1 DESCRIPTION AND APPLICATION OF RATES AND CHARGES

C.3. (Cont'd)

- f. For optional features, additions and changes associated with WATS Access Service, the one-half nonrecurring charge is assessed the "first" installation charge for the first line or trunk and each additional line or trunk is assessed the "each additional" installation charge for Interface Group 6, per Access Order. This charge applies for all Network Channel Interface (NCI) codes associated with a WATS access line. If two or more optional features and changes are ordered on the same Access Order, the optional feature or change requiring the lowest level of work activity will apply. A maximum one-half nonrecurring charge will apply per Access Order for service rearrangements. If a feature is not required on each line but rather for an entire hunt group, only one such charge will apply (i.e., it will not apply per line). This one-half nonrecurring charge is assessed the "first" installation charge for the first hunt group and each additional hunt group is assessed the "each additional" installation charge per Interface Group 6, per Access Order. Nonrecurring charges for service rearrangements are specified in 6.8, following.
- g. Service rearrangement charges are applicable, as set forth in d., preceding, when Alternate Traffic Routing, as described in 6.3.1, preceding, is added, changed or removed from an existing trunk group. Service rearrangement charges are not applicable when the following Alternate Traffic Routing changes are requested:
- renaming a high usage group to be an intermediate high usage group and the delivery of the originating traffic (i.e., the overflowing traffic) is not changing,
 - renaming an intermediate high usage group to be a high usage group and the delivery of the originating traffic (i.e., the overflowing traffic) is not changing, or
 - renaming a trunk group (i.e., a direct final) to be an alternate final trunk group.
- h. Nonrecurring charges for additional (i.e., two or more) CICs are determined based on whether the FGB or FGD trunk(s) or trunk group(s) are new or existing, the Interface Group Category rate and the level of work activity (i.e., trunk, trunk group, end office and/or tandem).

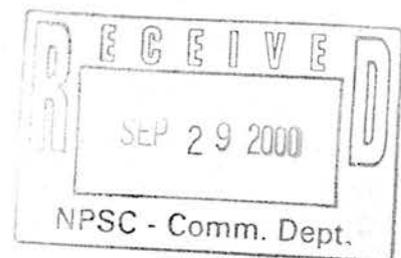

Qwest Corporation
Access Service
Catalog

SECTION 6

Page 99

Release 1

Effective: 9-29-2000

State of Nebraska
Notified: 9-29-2000

6. SWITCHED ACCESS SERVICE

6.7 RATE TERMS AND CONDITIONS

6.7.1 DESCRIPTION AND APPLICATION OF RATES AND CHARGES

C.3.h. (Cont'd)

When the trunk or trunk group is new, one CIC is included in the nonrecurring charges for the initial Access Order. Each additional CIC requested on the same Access Order is assessed one-half the "each additional" installation charge assessed by Interface Group Category. In addition, the charge is based on the lowest level of work, per Access Order, per LATA. The additional (i.e., two or more) CIC service rearrangement charge is in addition to Installation Charge(s) for the trunk(s).

When the FGB or FGD trunk group is existing service and the customer is requesting additional CICs on an existing tandem-routed trunk group, the customer is charged one-half the "first" installation charge at the tandem and one-half the "each additional" installation charge at each subtending end office for the "first additional" CIC on the Access Order, assessed by Interface Group Category. Each "additional" CIC after the "first additional" CIC on the same Access Order is charged one-half the "each additional" installation charge at the tandem and one-half the "each additional" installation charge per subtending end office, per LATA, based on the Interface Group Category.

When the FGB or FGD trunk group is existing service and the customer is requesting additional CICs on a direct-routed trunk group, the customer is charged one-half the "first" installation charge for the "first additional" CIC and one-half the "each additional" installation charge for each "additional" CIC after the "first additional" CIC on the same Access Order, per end office, per LATA, based on the Interface Group Category.

When the FGB or FGD trunk or trunk group is new or existing and the customer is requesting CICs for both a direct and tandem route, the Company will exclude the direct-routed end offices from the end office count when calculating the tandem-routed trunk group service rearrangement charges when the following conditions are met: 1) the CICs requested are the same on each order, 2) the Access Orders are received at the same time 3) the Access Orders are due on the same date and 4) the LATA is the same.

- i. Service rearrangement charges are applicable, as set forth in d., preceding when the customer has Signaling System Seven (SS7) Out of Band Signaling and chooses to change the existing point code on the existing trunk(s). If the point code in the STP is changed for the associated CCSAC link(s), a CCSAC Option Activation charge, as set forth in Section 15, following, also applies.

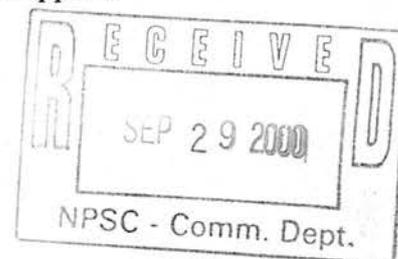

NOTICE

THE INFORMATION CONTAINED IN THIS DOCUMENT IS SUBJECT TO CHANGE.
NE2000-054

6. SWITCHED ACCESS SERVICE

6.7 RATE TERMS AND CONDITIONS

6.7.1 DESCRIPTION AND APPLICATION OF RATES AND CHARGES

C. Nonrecurring Charges (Cont'd)

4. Rearrangement to SS7 Out of Band Signaling

Rearrangement of existing FGD MF signaling or upgrades in Lineside or Trunkside Switched Access Service to FGD trunk groups equipped with SS7 out of band signaling will be performed at Company tandems and end offices designated as having SS7 capabilities. SS7 Out of Band Signaling Rearrangement Charges will apply when the following conditions are met:

- The same customer premises, quantity of lines or trunks, routing, traffic type, Interface Group category and optional features are maintained. Exceptions to this condition are set forth in I., following.
- Rearrangement from a one-way or two-way transmission when the signaling is changing to SS7 Out of Band Signaling will be by trunk group(s) ordered and received at the same time.
- Multiple lines or trunk groups may be combined into a single FGD trunk group with SS7 Out of Band Signaling when all trunks within the group are traffic engineered as a unit and all the communications paths within the group are interchangeable.
- The disconnect date and connect date on the Access Orders must be the same date when rearranging to a FGD trunk group with SS7 Out of Band Signaling.
- Upgrades from Lineside or Trunkside service types to FGD Switched Access Service with SS7 Out of Band Signaling are available when the above conditions are met.

When Switched Access Service is rearranged to FGD with SS7 Out of Band Signaling, the customer will be charged a Service Order Rearrangement charge and Trunk Rearrangement charges. The Service Order Rearrangement charge is assessed per access order, per Interface Group. The SS7 Trunk Rearrangement charge is applied per trunk in each SS7 Out of Band Signaling trunk group. The first trunk in the SS7 Out of Band Signaling trunk group will be charged the "first trunk" charge and each additional trunk in the same group will be charged the "each additional" trunk charge. Service Order and Trunk Rearrangement charges are sensitive to whether the transmission (one-way or two-way) is changing. These charges are set forth in 6.8, following.

The description and application of rates and charges when rearranging FGD service to SS7 Out of Band Signaling and Clear Channel Capability are set forth in I., following.

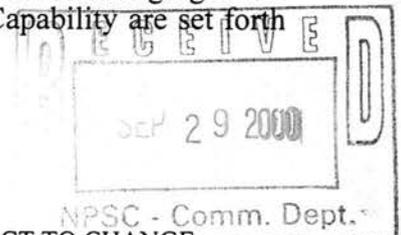

6. SWITCHED ACCESS SERVICE

6.7 RATE TERMS AND CONDITIONS

6.7.1 DESCRIPTION AND APPLICATION OF RATES AND CHARGES

C. Nonrecurring Charges (Cont'd)

5. Rearrangement of FGB or FGD Trunks from a Company Access Tandem Route to a Direct Route. (N)

When the customer requests the rearrangement of existing FGB or FGD trunks from a Company access tandem route to an end office direct route, charges are determined as set forth following.

When the customer has the DTT rating option between the SWC of the customer's premises and the access tandem and is requesting DTT to an end office, a rearrangement charge, as set forth in 6.8.1.D.4., following, is assessed if the following conditions are met.

- The rearrangement charge is assessed in association with the Interface Group, 1, 2, 6 or 9, and is applied per trunk in each direct routed access trunk group. The first trunk in the direct routed access trunk group is charged the "first trunk" charge and each additional trunk is charged the "each additional" trunk charge.
- The same customer premises, service type and Interface Group category are maintained with the exception of a change in Interface Group category and service type as set forth in 6.7.4 and 6.7.5, following. If the quantity of trunks changing to direct routed access exceeds the number of trunks disconnecting from the Company access tandem, full nonrecurring installation charges will apply for the additional trunks.
- Customers may specify a change in traffic type and direction (i.e., one-way to two-way) at the time the order is received. (N)

6. SWITCHED ACCESS SERVICE

6.7 RATE TERMS AND CONDITIONS

6.7.1 DESCRIPTION AND APPLICATION OF RATES AND CHARGES

C. Nonrecurring Charges

5. Rearrangement of FGB or FGD Trunks from a Company Access Tandem Route to a Direct Route. (Cont'd)

- Customers may specify a change in optional features (except Switched Transport multiplexing) at the time the order is received. If the optional feature has a separate nonrecurring charge, that nonrecurring charge will apply in addition to the rearrangement charge. Requests for a rearrangement from MF to SS7 out of band signaling must be received on a separate access order.
- All trunks will be rearranged into 24 trunks within a direct routed access trunk group.
- The order to disconnect the tandem route and to connect the end office DTT shall be placed at the same time. The disconnect date of the tandem route order may be negotiated with the Company not to exceed 30 days from the connect date of the end office DTT order with the exception of a change in service type as set forth in 6.7.5, following.
- Customer specified rearrangement requests will be cooperatively negotiated with the customer and are subject to the availability of Company switching equipment and other existing facilities.

(N)

(N)

NOTICE

Qwest Corporation
Access Service
Catalog

SECTION 6

Page 101

Release 1

State of Nebraska
Notified: 9-29-2000

Effective: 9-29-2000

6. SWITCHED ACCESS SERVICE

6.7 RATE TERMS AND CONDITIONS

6.7.1 DESCRIPTION AND APPLICATION OF RATES AND CHARGES

C. Nonrecurring Charges (Cont'd)

6. Rearrangement of 800 DB Access Service from Tandem Routing to Direct Routing

When the customer requests the rearrangement of 800 DB Access Service from tandem routing to direct routing, no charge shall apply for the customer requested rearrangement as long as the following conditions are met:

- The same customer premises, service type and Interface Group category are maintained with the exception of a change in service type as set forth in 6.7.4 and 6.7.5, following.
- The end office must subtend the tandem which service is being rearranged from.
- The customer must disconnect one trunk at the tandem for each rerouted end office trunk installed. Trunk rearrangements for more than one-for-one must be determined on an equivalent basis substantiated by industry accepted engineering standards and mutually agreed upon by the Company and the customer.
- The customer may specify a change in traffic type and direction (i.e., one-way to two-way) at the time the order is received.
- The customer may specify a change in optional features (except Switched Transport multiplexing) at the time the order is received. If the optional feature has a separate nonrecurring charge, that nonrecurring charge will apply. Request for a rearrangement from MF to SS7 out of band signaling must be received on a separate access order.
- The Company must receive an ASR to connect 800 DB Access Service at the end office within six (6) months of the end office becoming SSP capable. The customer must place the order to disconnect from the tandem at the same time the order is placed to connect at the end office. The disconnect date may be negotiated with the Company not to exceed 90 days from the connect date.
- Customer specified rearrangement requests will be cooperatively negotiated with the customer and are subject to the availability of Company switching equipment and other existing facilities.

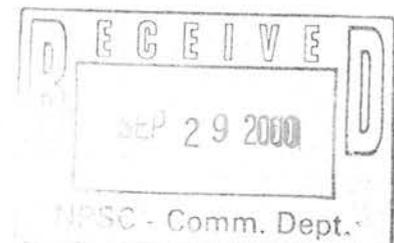

NOTICE

THE INFORMATION CONTAINED IN THIS DOCUMENT IS SUBJECT TO CHANGE.
NE2000-054

6. SWITCHED ACCESS SERVICE

6.7 RATE TERMS AND CONDITIONS

6.7.1 DESCRIPTION AND APPLICATION OF RATES AND CHARGES

C. Nonrecurring Charges (Cont'd)

7. Rollover

When a customer meets the rollover conditions, as set forth in (a), following, and is rearranging their facilities, as set forth in (b), following, a rollover charge shall apply to the lower speed facility as specified in 6.8, following. When the requested change does not meet the rollover conditions, then the appropriate nonrecurring charge applies as set forth in this section.

(a) Rollover Conditions

- The EF and/or DTT facilities are provided between the same customer locations as the original facilities, and
- all rollovers are performed at the same Company central office location, and
- all facilities involved in the rollover are provided by the Company.

(b) Rollover Service Rearrangements

- A lower speed Entrance Facility or DTT facility is to be placed on a higher speed facility, or
- moved from one higher speed facility to a different higher speed facility, or
- moved to a different channel on the same multiplexed facility.

If an order is required to rearrange the lines and/or trunks associated with a facility rollover, service rearrangement charges (e.g., Switched Transport per-line or per-trunk nonrecurring charges) may apply as set forth in C.3, preceding in addition to the facility rollover charges.

If an order is required to change the interface group category on the lines and/or trunks associated with a facility rollover, then the terms and conditions as set forth in 6.7.4, following, apply in addition to the facility rollover charge.

If an order is required to change the Switched Access Service type on the lines and/or trunks associated with a facility rollover, then the terms and conditions as set forth in 6.7.5, following, apply in addition to the facility rollover charge.

(N)

(N)

NOTICE

Qwest Corporation
Access Service
Catalog

SECTION 6

Page 102

Release 1

Effective: 9-29-2000

State of Nebraska

Notified: 9-29-2000

6. SWITCHED ACCESS SERVICE

6.7 RATE TERMS AND CONDITIONS

6.7.1 DESCRIPTION AND APPLICATION OF RATES AND CHARGES (Cont'd)

D. Application of Rates

Tandem Switched Transport and Local Switching usage rates are applied per access minutes.

1. When originating FGD is not available in an end office, and terminating FGD service to an access tandem in a LATA is available, such terminating FGD service may be used, at the option of the customer, to terminate FGD calls to that end office. FGD rates apply to all access minutes associated with such calls.
2. Where originating and/or terminating recording capability does not exist for FGA and FGB provided to an entry switch, the number of access minutes will be assumed as set forth in 6.7.7, following.
3. The Company will provide written notification to all access customers of record within a particular LATA that an end office in that LATA is scheduled to be converted to an equal access end office. This notification will be sent, via certified U.S. Mail, to each customer of record in the LATA where the conversion is scheduled to occur, at least six months in advance of the conversion date.
4. The customer will have the choice of converting existing services to equal access (i.e., originating and terminating Feature Group D) at no charge, pursuant to the conditions set forth in 6.7.5, following, or retaining the existing services.
5. Where Switched Access Service is provided to a carrier in conjunction with a Commercial Mobile Radio Service provider, the Company shall apply the rates as set forth in 2.4.8, preceding.

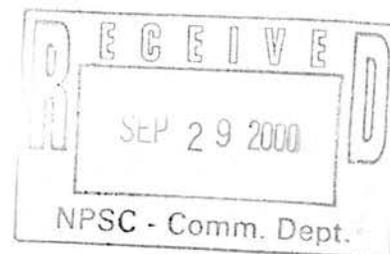

NOTICE

THE INFORMATION CONTAINED IN THIS DOCUMENT IS SUBJECT TO CHANGE.
NE2000-054

State of Nebraska
Notified 5-9-2013

6. SWITCHED ACCESS SERVICE

6.7 RATE TERMS AND CONDITIONS

6.7.1 DESCRIPTION AND APPLICATION OF RATES AND CHARGES

D. Application of Rates (Cont'd)

6. Density Zone Pricing Plan

Nebraska is divided into three geographic zones determined by the traffic density originating from and terminating to various end offices. Density zones are designated by wire center in the National Exchange Carrier Association, Inc., Tariff F. C. C. No. 4.

(C)

(C)

(C)

NOTICE

THE INFORMATION CONTAINED IN THIS DOCUMENT IS SUBJECT TO CHANGE.
NE2013-002

Qwest Corporation
Access Service
Catalog

SECTION 6
Page 104
Release 2
Effective: 6-16-2008

State of Nebraska
Notified: 6-5-2008

6. SWITCHED ACCESS SERVICE

6.7 RATE TERMS AND CONDITIONS

6.7.1 DESCRIPTION AND APPLICATION OF RATES AND CHARGES (Cont'd)

(T)
(D)

(D)

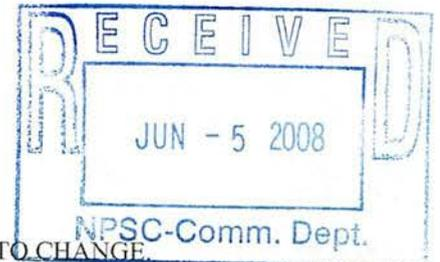

Qwest Corporation
Access Service
Catalog

SECTION 6
Page 105
Release 2
Effective: 6-16-2008

State of Nebraska
Notified: 6-5-2008

6. SWITCHED ACCESS SERVICE

6.7 RATE TERMS AND CONDITIONS

6.7.1 DESCRIPTION AND APPLICATION OF RATES AND CHARGES (Cont'd)

(T)
(D)

(D)



Qwest Corporation
Access Service
Catalog

SECTION 6
Page 106
Release 1

State of Nebraska
Notified: 9-29-2000

Effective: 9-29-2000

6. SWITCHED ACCESS SERVICE

6.7 RATE TERMS AND CONDITIONS

6.7.1 DESCRIPTION AND APPLICATION OF RATES AND CHARGES (Cont'd)

E. 800 DB Access Service

An 800 Carrier Identification Charge is assessed per call to the service provider the call is delivered to in accordance with SMS/800 information residing in the Company's SCP.

A POTS Translation Charge is assessed per call, in addition to the 800 Carrier Identification Charge, when the POTS number is delivered to the service provider instead of the 8XX number in accordance with SMS/800 information residing in the Company's SCP. The POTS Translation feature is described in 6.2.5, preceding.

A Call Handling and Destination Feature Charge is assessed to the service provider the call is intended for on a per-query basis, for each 8XX query to the Company's SCP that utilizes a Call Handling and Destination feature as described in 6.2.5, preceding. The query rate is assessed for all completed queries whether or not the actual 8XX call is delivered to the service provider.

These rates and charges are in addition to the rates and charges for the rate categories described in 6.1.2, preceding, which are applicable to all Switched Access Service. The 800 Data Base Access Service rates are set forth in 6.8.2, following.

F. 900 Access Service Customer Identification Charge

A 900 Access Service Customer Identification Charge is assessed for each 900 call delivered to the customer. This charge is in addition to the rates and charges for the rate categories described in 6.1.2, preceding, which are applicable to all Switched Access Services. The per-call rate is set forth in 6.8, following.

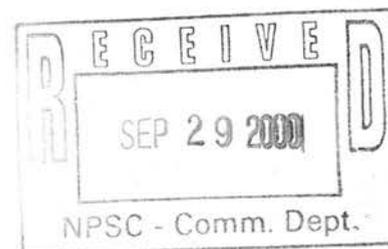

6. SWITCHED ACCESS SERVICE

6.7 RATE TERMS AND CONDITIONS

6.7.1 DESCRIPTION AND APPLICATION OF RATES AND CHARGES (Cont'd)

G. 900 Access Service Nonrecurring Charge

In addition to the rates and charges for the rate categories described in 6.1.2, preceding, which are applicable to all Switched Access Services, the following charges apply to 900 Access Service:

1. There are two additional charges which apply to 1+900 Service to activate the 900 NXX code(s) for each end office. These charges are assessed on a first and subsequent NXX per access order, per screening location. The screening location, end office or tandem, is determined by where the six-digit translation of the 900 NXX portion of the dialed number is performed. These charges are set forth in 6.8, following.
2. There are two additional charges which apply to expanded 0+900 Service to activate the Expanded 900 Option. These charges are assessed per access order, per screening location, end office or tandem with NXX activity or can be ordered without NXX activity. The Expanded 900 Option is not offered without 1+900 Access Service within a LATA and is available only with Feature Group D Service in suitably equipped Company End Offices. These charges are set forth in 6.8, following.

H. Multiple POTs Tandem Sectorization Nonrecurring Charge

The nonrecurring charges for MPTS are described as follows.

The MPTS ASR charge applies when a customer is ordering MPTS without associated trunk activity on the same order. This charge applies whether the order is to initially add sectors, or make rearrangements to an existing sector(s). Trunk activity includes installing new trunks, adding additional trunks, rearranging existing trunks or removing trunks. This charge is in addition to the MPTS establishment charge (without associated trunk activity) and the MPTS rearrangement charge (without associated trunk activity).

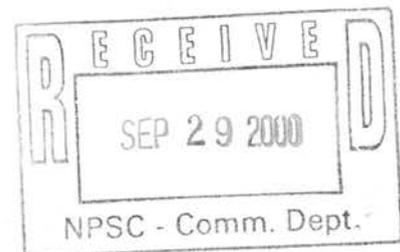

6. SWITCHED ACCESS SERVICE

6.7 RATE TERMS AND CONDITIONS

6.7.1 DESCRIPTION AND APPLICATION OF RATES AND CHARGES

H. Multiple POTs Tandem Sectorization Nonrecurring Charge (Cont'd)

The MPTS establishment charge (without associated trunk activity) applies when a customer orders MPTS Service without associated trunks activity on the same order. The MPTS establishment charge (with associated trunk activity) applies when a customer orders MPTS Service with associated trunk activity on the same order.

The MPTS rearrangement charge (without associated trunk activity) applies when a customer orders rearrangements to established MPTS service without associated trunk activity on the same order. The MPTS rearrangement charge (with associated trunk activity) applies when a customer orders rearrangements to established MPTS service with associated trunk activity on the same order. These charges are set forth on 6.8, following.

I. Clear Channel Capability (CCC)

When Clear Channel Capability (CCC) is ordered and installed coincident with the initial installation of FGD Service, a CCC nonrecurring charge applies per trunk group in addition to the initial installation charge(s) for FGD Service. Rates and charges for CCC are as set forth in 6.8, following.

When CCC is ordered on existing trunk-side service, the service may be rearranged when the following conditions are met:

1. The customer changes from FGD Service with multifrequency signaling to FGD Service with SS7 Out of Band Signaling and Clear Channel Capability with no other change in optional features.
2. The customer changes from FGD Service with SS7 Out of Band Signaling to FGD Service with SS7 Out of Band Signaling and Clear Channel Capability with no other change in optional features.

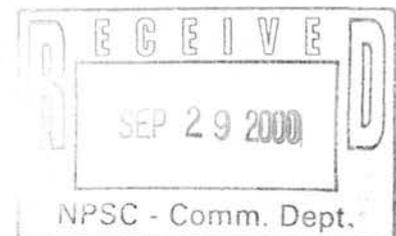

NOTICE

Qwest Corporation
Access Service
Catalog

SECTION 6

Page 109

Release 1

State of Nebraska
Notified: 9-29-2000

Effective: 9-29-2000

6. SWITCHED ACCESS SERVICE

6.7 RATE TERMS AND CONDITIONS

6.7.1 DESCRIPTION AND APPLICATION OF RATES AND CHARGES

- I. Clear Channel Capability (CCC) (Cont'd)
 3. The same customer premises, quantity of trunks, service type, direct routing and Interface Group Category 6 or 9 are maintained.
 4. The traffic type on FGD Service is changed to the Clear Channel Capability originating and/or terminating traffic type as set forth in 6.1.1, preceding.
 5. All service orders are received at the same time and the disconnect date and the connect date are the same when rearranging trunk groups from MF to SS7 Out of Band Signaling with Clear Channel Capability.
 6. Multiple MF trunk groups may be combined into a single SS7 trunk group with Clear Channel Capability when all trunks within the group are traffic engineered as a unit and all the communication paths within the group are interchangeable.

Rearrangement charges from FGD Service with multifrequency signaling to FGD Service with SS7 Out of Band Signaling and Clear Channel Capability will be assessed the nonrecurring charges as set forth in 6.8, following.

Rearrangement charges from FGD Service with SS7 Out of Band Signaling to FGD Service with SS7 Out of Band Signaling and Clear Channel Capability will be assessed the "first trunk" charge in association with interface Group Category 6 or 9 service. Each additional trunk will be assessed the "each additional trunk" charge in association with Interface Group Category 6 or 9 service. The nonrecurring charge for Clear Channel Capability, as set forth in 6.8, following, is assessed per trunk group in addition to the nonrecurring charges per trunk as set forth in 6.8, following.

The removal of the CCC arrangement from existing trunk-side service will be treated as a discontinuance of the existing service and installation of new service. All associated nonrecurring installation charges will apply for the new service. A new minimum period will be established for the new service.

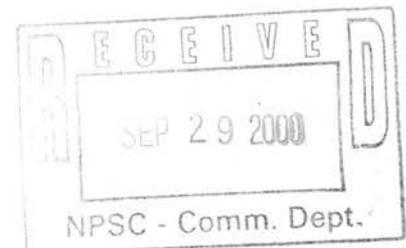

NOTICE

THE INFORMATION CONTAINED IN THIS DOCUMENT IS SUBJECT TO CHANGE.
NE2000-054

6. SWITCHED ACCESS SERVICE

6.7 RATE TERMS AND CONDITIONS

6.7.1 DESCRIPTION AND APPLICATION OF RATES AND CHARGES (Cont'd)

J. Entrance Facility

The Entrance Facility monthly rate is assessed based on the type of facility provided, Voice Grade, DS1 or DS3. When Lineside Switched Access Service is provided, the Voice Grade Entrance Facility rate is assessed for each Lineside service provided, unless the customer requests a DS1 or DS3 Entrance Facility. The Entrance Facility rate is assessed even when the customer's premises and the SWC are located in the same building. The Entrance Facility rate is in addition to the rates assessed for DTT and TST. Rates are set forth in 6.8, following.

K. Direct-Trunked Transport

1. Except as set forth in 2. and 3., following, for each DTT facility provided, Voice Grade, DS1 or DS3, a fixed monthly rate, per mile band, and a monthly rate per mile is assessed. The DTT rates are in addition to the Entrance Facility rate. Mileage measurement is described in 6.7.11, following. Rates and charges are set forth in 6.8, following.
2. When Lineside Switched Access service is provided, the Voice Grade DTT rates are assessed for each Lineside service, unless the customer requests a DS1 or DS3 facility. DTT rates are assessed between the SWC of the customer's premises and the dial tone office. When traffic is terminated in an end office which is not the dial tone office, Tandem Transmission rates, as set forth in L., following, are assessed between the dial tone office and the end office where the traffic terminates. The Tandem Transmission rates are in addition to the DTT rates. Tandem Switching rates will not be assessed.
3. When the customer orders DTT to a remote switching system or module (RSS or RSM), DTT rates are assessed between the SWC and the host office and Tandem Transmission rates, as set forth in L., following, are assessed between the host and the RSS or RSM. Mileage measurement rules are set forth in 6.7.11, following. Tandem Switching rates will not be assessed.

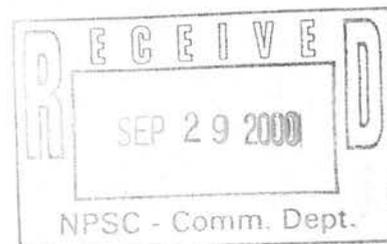

NOTICE

6. SWITCHED ACCESS SERVICE

6.7 RATE TERMS AND CONDITIONS

6.7.1 DESCRIPTION AND APPLICATION OF RATES AND CHARGES (Cont'd)

L. Tandem-Switched Transport

The TST rate category is composed of Tandem Transmission, Tandem Switching, Access Tandem Trunk Port and Common Transport Multiplexing rates. Mileage measurement is described in 6.7.11, following. Rates and charges are set forth in 6.8, following.

1. Tandem Transmission

The Tandem Transmission rates are assessed on a per-MOU basis when tandem routing is provided for trunkside services. Tandem Transmission rates are also assessed to FGA Service when traffic is terminated in an end office that is not the dial tone office as set forth in 6.7.11, following. The Tandem Transmission rates are portrayed in mileage bands. There are two rates that apply for each band, a fixed rate per band and a rate per mile, per minute.

2. Tandem Switching

The Tandem Switching rate is assessed on a per-MOU basis to all Switched Access minutes when tandem switching functions are utilized. Tandem Switching is not assessed to FGA Service.

3. Access Tandem Trunk Port

The Access Tandem Trunk Port (ATTP) is a monthly rate assessed per Feature Group trunk in service terminating on the SWC side of the access tandem. If the customer combines DA with trunkside Switched Access Service, only one ATTP charge is assessed per trunk. ATTP is not assessed to FGA.

4. Common Transport Multiplexing

Common transport multiplexing is a per-MOU rate assessed to all Switched Access minutes utilizing common transport from the access tandem to all subtending end offices for trunkside services. Nonrecurring charges are not assessed for common transport multiplexing.

M. Multiplexing associated with EF and DTT facilities

The multiplexing monthly rate is assessed on a per-arrangement basis.

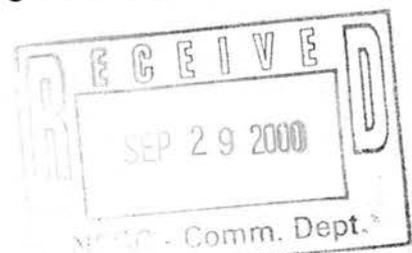

NOTICE

THE INFORMATION CONTAINED IN THIS DOCUMENT IS SUBJECT TO CHANGE.
NE2000-054

6. SWITCHED ACCESS SERVICE

6.7 RATE TERMS AND CONDITIONS (Cont'd)

6.7.2 MINIMUM PERIODS

Minimum periods are described in 5.2.5, preceding.

6.7.3 MINIMUM MONTHLY CHARGE

Switched Access Service is subject to a minimum monthly charge. The minimum charge applies for the total capacity provided. The minimum monthly charge consist of the following elements:

The minimum monthly charge for usage rated elements is the sum of the charges set forth in 6.8, following, for the measured or assumed usage for the month.

For monthly rated elements, the minimum monthly charge is the monthly rate as set forth in 6.8, following.

When FGA services are provided where actual measurement capabilities do not exist, the customer will always be billed for the assumed average number of access minutes for all applicable usage rated elements.

6.7.4 CHANGE OF SWITCHED ACCESS INTERFACE GROUP CATEGORY

Changes from one Switched Access Service Interface Group Category to another will be treated as a discontinuance of service and the installation of service with the establishment of a new minimum period as set forth in 5.2.5, preceding. When the following conditions are met, the nonrecurring charges will not apply:

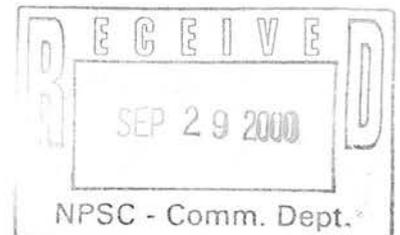

6. SWITCHED ACCESS SERVICE

6.7 RATE TERMS AND CONDITIONS

6.7.4 CHANGE OF SWITCHED ACCESS INTERFACE GROUP CATEGORY (Cont'd)

A. Interface Group Category 6 (IG6) on Feature Group B Service to Interface Group Category 9 (IG9) on Feature Group B and Feature Group D Service.

- The same customer premises, quantity of trunks, routing, traffic type, direction (i.e., one-way, two-way), and optional features are maintained.
- The orders for the change from IG6 to IG9 are received at the same time.
- The trunks are upgraded from IG6 to IG9 in groups of 24 trunks.
- In accordance with 6.7.5, following, the disconnect date for the FGB Service with IG6 is no more than 90 days from the connect date of the FGD Service with IG9.
- The disconnect date for IG6 is the connect date for IG9 when the FGB service type is not changing.

B. Interface Group Category 6 to Interface Group Category 9 on Feature Group D Service

- The same customer premises, quantity of trunks, service type, routing, traffic type, direction (i.e., one-way, two-way), and optional features are maintained.
- The orders for the change from IG6 to IG9 are received at the same time.
- The trunks are upgraded from IG6 to IG9 in groups of 24 trunks.
- The disconnect date for IG6 is the connect date for IG9.

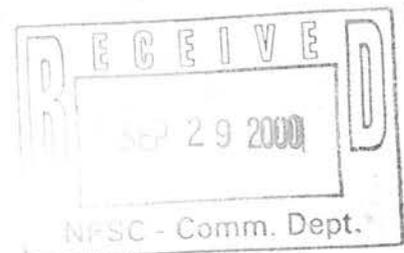

6. SWITCHED ACCESS SERVICE

6.7 RATE TERMS AND CONDITIONS (Cont'd)

6.7.5 CHANGE OF SWITCHED ACCESS SERVICE TYPE

Changes from one type of Switched Access Service to another will be treated as a discontinuance of service and the installation of service with the establishment of a new minimum period as set forth in 5.2.5, preceding. When the following conditions are met, the nonrecurring charges will not apply:

A. Service Type Upgrade From FGA Or FGB To FGD Service

1. The same customer premises, quantity of trunks, routing, traffic type, direction (i.e., one-way, two-way), and optional features are maintained.
2. The orders for the disconnect of the FGA or FGB Service and the start of FGD Service are placed with the Company at the same time.
3. The same interface group category is maintained (except as set forth in 6.7.4, preceding).
4. The disconnect date for the FGA or FGB Service is no more than 90 days from the connect date of the FGD Service.
5. At the customer's option, the Company will allow a change to SS7 Out of Band Signaling and a change in direction from one-way to two-way at the same time as the service type upgrade. When this kind of request is received, the customer will be assessed a SS7 Rearrangement Charge when conditions in 6.7.1, preceding and the above conditions are met. A new minimum period as set forth in 5.2.5, preceding, will also be established.

B. Service Type Upgrade From FGC Service To FGD Service

1. When a FGC Service is upgraded to a FGD Service, the nonrecurring charge will not apply. Because FGC is no longer available in an end office once the end office is equipped with equal access capabilities, (i.e., FGD), such upgrades will be performed by the Company without the customer being required to place an order for the change, unless a customer specifies an increase in the number of transmission paths.
2. When the effective dates for the disconnect and start of service are the same, the minimum period as set forth in 5.2.5, preceding, will not change. When the effective dates for the disconnect and start of service are different, a new minimum period will be established for the FGD Service. For all other changes other than a change in service type, a new minimum period will be established on FGD.

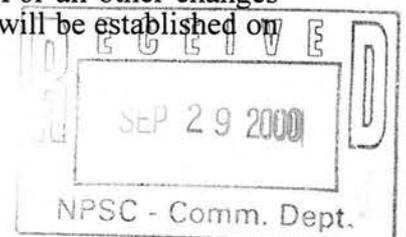

NOTICE

6. SWITCHED ACCESS SERVICE

6.7 RATE TERMS AND CONDITIONS

6.7.5 CHANGE OF SWITCHED ACCESS SERVICE TYPE

B. Service Type Upgrade From FGC Service To FGD Service (Cont'd)

3. At the customer's option, the Company will allow a change to SS7 Out of Band Signaling and a change in direction from one-way to two-way to occur at the same time the FGC is upgraded to FGD. When this kind of request is received, the customer will be assessed a SS7 Rearrangement Charge when conditions in 6.7.1, preceding, are met. When upgrading FGC to FGD with SS7 Out of Band Signaling, the disconnect date and the connect date on the orders must be the same date and a new minimum period will apply on the FGD service.
4. If a customer has the optional feature, Multiple POTs Tandem Sectorization (MPTS) and a non-equal access end office is upgraded to an equal access end office within the tandem serving area, the MPTS nonrecurring charges do not apply.

6.7.6 MOVES

A move involves a change in the physical location or reconfiguration of the following:

- The POT of the Entrance Facility (EF) at the customer's premises is moving
- The customer's premises and associated EF is moving
- The DTT facility and associated Lineside and/or Trunkside Switched Access Services are reconfigured as set forth in A. and B., following.

The charges for a move or reconfiguration are dependent on whether the move or reconfiguration is within the same SWC as set forth in A., following, or to a different SWC as set forth in B., following. New minimum period requirements will be established for moved or reconfigured services. Any changes to the existing Switched Access facilities, lines, trunks, and optional features as they exist at the current location, excluding a change in Circuit Facility Assignment (CFA), made in conjunction with a move or reconfiguration, will be treated as a discontinuance and a start of new service and all associated nonrecurring installation charges will apply. The addition of lines and trunks made in conjunction with a move or reconfiguration will be treated as a start of new service and all associated nonrecurring installation charges and new minimum period requirements will apply. The customer will also remain responsible for satisfying all outstanding minimum period charges for any disconnected service as the result of a move or reconfiguration.

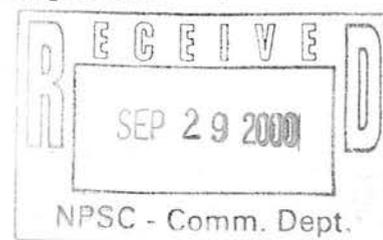

NOTICE

THE INFORMATION CONTAINED IN THIS DOCUMENT IS SUBJECT TO CHANGE.
NE2000-054

6. SWITCHED ACCESS SERVICE

6.7 RATE TERMS AND CONDITIONS

6.7.6 MOVES (Cont'd)

- A. Application of Move Charges Within the Same Serving Wire Center (SWC)
1. EF Move to a New Location Within the Same Building, same SWC, for the Same Customer

The charge for moving an EF to a new location within the same building, same SWC, for the same customer, is one-half of the Move Within the Same Serving Wire Center charge as set forth in 6.8.1, following. The first line or trunk is assessed one-half of the "first" move charge and each additional line or trunk is assessed one-half of the "each additional" move charge per Interface Group 1, 2, 6 or 9, per Access Order.

2. Reconfiguration of a DTT Facility and Associated Lineside or Trunkside Switched Access Services from an EF of One Customer to an EF of Another Customer or to an EICT[1], all Within the Same Building, Same SWC

The charge for reconfiguring a DTT facility and associated Lineside or Trunkside Switched Access Services from an EF of one customer to (a) an EF of another customer where its customer premises is located within the same building, same SWC, or (b) to an EICT located within the same building, same SWC, is one-half of the Move Within the Same Serving Wire Center charge as set forth in 6.8.1, following. The first line or trunk is assessed one-half of the "first" move charge and each additional line or trunk is assessed one-half of the "each additional" move charge per Interface Group 1, 2, 6 or 9, per Access Order. The customer providing the EF or EICT is responsible for providing the CFA and is assessed an EF or EICT Nonrecurring Installation charge when a new EF or EICT is ordered.

[1] Expanded Interconnection Channel Termination (EICT) as set forth in Section 21, following.

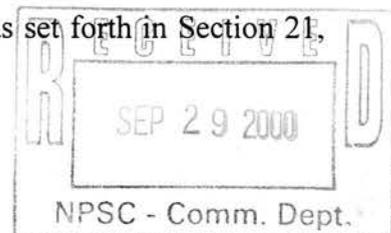

NOTICE

THE INFORMATION CONTAINED IN THIS DOCUMENT IS SUBJECT TO CHANGE.
NE2000-054

6. SWITCHED ACCESS SERVICE

6.7 RATE TERMS AND CONDITIONS

6.7.6 MOVES

- A. Application of Move Charges Within the Same Serving Wire Center (SWC)
(Cont'd)
3. Reconfiguration of a DTT Facility and Associated Lineside or Trunkside Switched Access Services from One EICT to Another EICT, all Within the Same Building, Same SWC

The charge for reconfiguring a DTT facility and associated Lineside or Trunkside Switched Access Services from one EICT to another EICT within the same building, same SWC, is one-half of the Move Within the Same Serving Wire Center charge as set forth in 6.8.1, following. The first line or trunk is assessed one-half of the "first" move charge and each additional line or trunk is assessed one-half of the "each additional" move charge per Interface Group 1, 2, 6 or 9, per Access Order. The customer providing the EICT is responsible for providing the CFA and is assessed an EICT Nonrecurring Installation charge when a new EICT is ordered.

4. Reconfiguration of a DTT Facility and Associated Lineside or Trunkside Switched Access Services from an EICT to an EF, all Located Within the Same Building, same SWC

The charge for reconfiguring a DTT facility and associated Lineside or Trunkside Switched Access Services from an EICT to an EF where its customer premises is located within the same building, same SWC, is one-half of the Move Within the Same Serving Wire Center charge as set forth in 6.8.1, following. The first line or trunk is assessed one-half of the "first" move charge and each additional line or trunk is assessed one-half of the "each additional" move charge per Interface Group 1, 2, 6 or 9, per Access Order. The customer providing the EF is responsible for providing the CFA and is assessed an EF Nonrecurring Installation charge when a new EF is ordered.

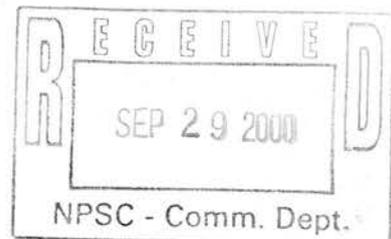

Qwest Corporation
Access Service
Catalog

SECTION 6
Page 118
Release 1

State of Nebraska
Notified: 9-29-2000

Effective: 9-29-2000

6. SWITCHED ACCESS SERVICE

6.7 RATE TERMS AND CONDITIONS

6.7.6 MOVES

**A. Application of Move Charges Within the Same Serving Wire Center (SWC)
(Cont'd)**

5. EF Move to a Different Building, Same SWC for the Same Customer

The charge for moving an EF to a different building, same SWC, for the same customer is the Move Within the Same Serving Wire Center charge as set forth in 6.8.1, following. The first line or trunk is assessed the "first" move charge and each additional line or trunk is assessed the "each additional" move charge per Interface Group 1, 2, 6 or 9, per Access Order. In addition, a full EF Nonrecurring Installation charge based on the capacity affected, per POT, per Access Order is assessed.

6. Reconfiguration of a DTT Facility and Associated Lineside or Trunkside Switched Access Services from an EF of One Customer to an EF of Another Customer or to an EICT Located in a Different Building, Same SWC

The charge for reconfiguring a DTT facility and associated Lineside or Trunkside Switched Access Services from an EF of one customer to (a) an EF of another customer where its customer premises is located in a different building, same SWC, or (b) to an EICT located in a different building, same SWC is the Move Within the Same Serving Wire Center charge as set forth in 6.8.1, following. The first line or trunk is assessed the "first" move charge and each additional line or trunk is assessed the "each additional" move charge per Interface Group 1, 2, 6 or 9, per Access Order. The customer providing the EF or EICT is responsible for providing the CFA and is assessed an EF or EICT Nonrecurring Installation charge when a new EF or EICT is ordered.

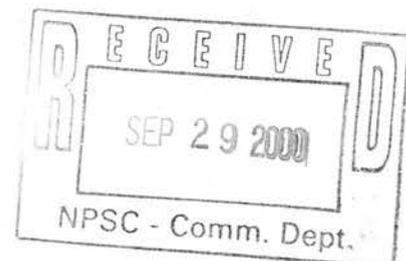

NOTICE

THE INFORMATION CONTAINED IN THIS DOCUMENT IS SUBJECT TO CHANGE.
NE2000-054

6. SWITCHED ACCESS SERVICE

6.7 RATE TERMS AND CONDITIONS

6.7.6 MOVES

**A. Application of Move Charges Within the Same Serving Wire Center (SWC)
(Cont'd)**

7. Reconfiguration of a DTT Facility and Associated Lineside or Trunkside Switched Access Services from an EICT to an EF Located in a Different Building, Same SWC

The charge for reconfiguring a DTT facility and associated Lineside or Trunkside Switched Access Services from an EICT to an EF where its customer premises is located in a different building, same SWC, is the Move Within the Same Serving Wire Center charge as set forth in 6.8.1, following. The first line or trunk is assessed the "first" move charge and each additional line or trunk is assessed the "each additional" move charge per Interface Group 1, 2, 6 or 9, per Access Order. The customer providing the EF is responsible for providing the CFA and is assessed an EF Nonrecurring Installation charge when a new EF is ordered.

B. Application of Move Charges to a Different Serving Wire Center (SWC)

1. EF Move to a Different SWC for the Same Customer

The charge for moving an EF to a different SWC for the same customer is assessed the Move to a Different Serving Wire Center charge as set forth in 6.8.1, following. The first line or trunk is assessed the "first" move charge and each additional line or trunk is assessed the "each additional" move charge per Interface Group 1, 2, 6 or 9, per Access Order. In addition, a full EF Nonrecurring Installation charge based on the capacity affected, per POT, per Access Order is assessed.

2. Reconfiguration of a DTT Facility and Associated Lineside or Trunkside Switched Access Services from an EF of One Customer to an EF of Another Customer or to an EICT in a Different SWC.

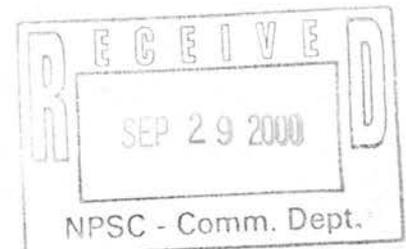

Qwest Corporation
Access Service
Catalog

SECTION 6

Page 120

Release 1

Effective: 9-29-2000

State of Nebraska
Notified: 9-29-2000

6. SWITCHED ACCESS SERVICE

6.7 RATE TERMS AND CONDITIONS

6.7.6 MOVES

B.2. (Cont'd)

The charge for reconfiguring a DTT facility and associated Lineside or Trunkside Switched Access Services from an EF of one customer to (a) an EF of another customer where its customer premises is served by a different SWC or (b) to an EICT located in a different SWC is the Move to A Different Serving Wire Center charge as set forth in 6.8.1, following. The first line or trunk is assessed of the "first" move charge and each additional line or trunk is assessed of the "each additional" move charge per Interface Group 1, 2, 6 or 9, per Access Order. The customer providing the EF or EICT is responsible for providing the CFA and is assessed an EF or EICT Nonrecurring Installation charge when a new EF or EICT is ordered.

3. Reconfiguration of a DTT Facility and Associated Lineside or Trunkside Switched Access Services from One EICT to Another EICT Located in a Different SWC

The charge for reconfiguring a DTT facility and associated Lineside or Trunkside Switched Access Services from one EICT to another EICT located in a different SWC is the Move to a Different Serving Wire Center charge as set forth in 6.8.1, following. The first line or trunk is assessed the "first" move charge and each additional line or trunk is assessed the "each additional" move charge per Interface Group 1, 2, 6 or 9, per Access Order. The customer providing the EICT is responsible for providing the CFA and is assessed an EICT Nonrecurring Installation charge when a new EICT is ordered.

4. Reconfiguration of a DTT Facility and Associated Lineside or Trunkside Switched Access Services from an EICT to an EF Located in a Different SWC

The charge for reconfiguring a DTT facility and associated Lineside or Trunkside Switched Access Services from an EICT to an EF where its customer premises is served by a different SWC is the Move to a Different Serving Wire Center charge as set forth in 6.8.1, following. The first line or trunk is assessed the "first" move charge and each additional line or trunk is assessed the "each additional" move charge per Interface Group 1, 2, 6 or 9, per Access Order. The customer providing the EF is responsible for providing the CFA and is assessed an EF Nonrecurring Installation charge when a new EF is ordered.

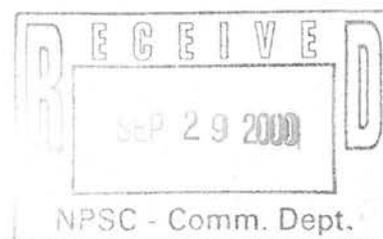

NOTICE

THE INFORMATION CONTAINED IN THIS DOCUMENT IS SUBJECT TO CHANGE.
NE2000-054

Qwest Corporation
Access Service
Catalog

SECTION 6

Page 121

Release 2

State of Nebraska
Notified: 6-1-2016

Effective: 7-1-2016

6. SWITCHED ACCESS SERVICE

6.7 RATE TERMS AND CONDITIONS (Cont'd)

6.7.7 MEASURING ACCESS MINUTES

Customer traffic to end office switches will be measured (i.e., recorded or assumed) by the Company at end office switches or access tandem switches. Originating and terminating calls will be measured (i.e., recorded or assumed) by the Company to determine the basis for computing chargeable access minutes. In the event the customer message detail is not available because the Company lost or damaged data files or experienced recording system outages, the Company shall estimate the volume of lost customer access minutes of use based on previously known values. The measured minutes are the chargeable access minutes for calls over the following serving arrangements:

(C)

- For terminating calls over
 - FGA
 - FGB
 - FGC to 800/800-type
 - FGD

- For terminating calls over
 - FGA used for resale
 - FGB
 - FGC (where measurement capability is available)
 - FGD

- For originating calls over FGA not used for resale

For originating calls over FGA not used for resale and FGC (where measurement capability is not available), chargeable originating access minutes are derived from recorded minutes in the following manner.

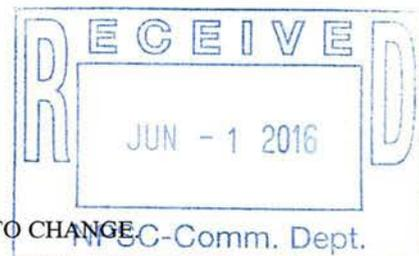

NOTICE

THE INFORMATION CONTAINED IN THIS DOCUMENT IS SUBJECT TO CHANGE
NE2016-001

6. SWITCHED ACCESS SERVICE

6.7 RATE TERMS AND CONDITIONS
6.7.7 MEASURING ACCESS MINUTES (Cont'd)

STEP 1

Obtain recorded originating minutes and messages (measured as set forth in A. and C., following for FGA not used for resale and FGC where measurement capability is not available respectively) from the appropriate recording data.

STEP 2

Obtain the total messages and attempts by multiplying the originating measured messages by the "attempts per message ratio". "Attempts per message ratios" (A/M) are obtained separately for the major call categories such as DDD, operator, 8XX, 900, Voice DA and international from a sample study which analyzes the ultimate completion status of the total attempts which receive acknowledgment from the customer. That is, Measured Messages divided by Completion Ratio equals Total Attempts.

STEP 3

Obtain the total non-conversation time additive (NCTA) by multiplying the total attempts (obtained in Step 2) by the NCTA per-attempt ratio. The NCTA per-attempt ratio is obtained from the sample study identified in Step 2 by measuring the non-conversation time associated with both completed and incomplete attempts. The total NCTA is the time on a completed attempt from customer acknowledgment of receipt of call to called party answer (set up and ringing) plus the time on an incomplete attempt from customer acknowledgment of call until the access tandem or end office receives a disconnect signal (ring - no answer, busy or network blockage). That is, Total Attempts times Non-Conversation Time times per Attempt Ratio equals Total NCTA.

STEP 4

Obtain total chargeable originating access minutes by adding the total NCTA (obtained in Step 3) to the recorded originating measured minutes (obtained in Step 1). That is, Measured Minutes plus NCTA equals Chargeable Originating Access Minutes.

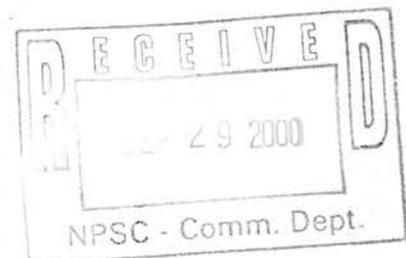

6. SWITCHED ACCESS SERVICE

6.7 RATE TERMS AND CONDITIONS

6.7.7 MEASURING ACCESS MINUTES (Cont'd)

Following is an example which illustrates how the chargeable originating access minutes are derived from the measured originating minutes using this formula.

Where:	Measured Minutes (M. Min.)	=	7,000
	Measured Messages (M. Mes.).....	=	1,000
	Attempts Per Message Ratio (A/M)	=	1.3330
	NCTA Per Attempt.....	=	.4
1.	Total Attempts = 1,000 (M. Mes.) x 1.333.....	=	1,333
2.	Total NCTA = .4 (NCTA per Attempt) x 1,333.....	=	533.2
3.	Total Chargeable Originating Access Minutes = 7,000 (M. Min.) + 533.2 (NCTA)	=	7,533.2

When assumed minutes are used, the assumed minutes are the chargeable access minutes.

FGA access minutes or fractions thereof, the exact value of the fraction being a function of the switch technology where the measurement is made, are accumulated over the billing period for each line or hunt group, and are then rounded up to the nearest access minute for each line or hunt group. FGB, FGC and FGD access minutes or fraction thereof, the exact value of the fraction being a function of the switch technology where the measurement is made, are accumulated over the billing period for each end office, and are then rounded up to the nearest access minute for each end office.

Assumed minutes are used for FGA Access Services which originate or terminate in end offices not equipped with measurement capabilities.



6. SWITCHED ACCESS SERVICE

6.7 RATE TERMS AND CONDITIONS
6.7.7 MEASURING ACCESS MINUTES (Cont'd)

The assumed average intrastate access minutes are set forth following.

- When an FGA service arranged for two-way calling is provided where neither the originating nor the terminating access minutes are recorded, the average intrastate access minutes will be assumed.

Where recording capability exists for either originating or terminating usage, but not both, on a line arranged for two-way calling, the number of access minutes per-line will be the assumed average intrastate access minutes, or the recorded usage, whichever is greater. If the usage in the measured direction exceeds the assumed number of minutes, it will be assumed there is zero usage in the unmeasured direction. If the measured usage is less than the assumed number of minutes, the usage in the unmeasured direction will be assumed to be the assumed number of access minutes minus the measured usage.

Assumed Average Intrastate Access Minutes: 4076

- When an FGA service arranged for originating calling only is provided where originating access minutes are not recorded, the average originating access minutes will be assumed, and no terminating access minutes will apply.

Assumed Average Originating Access Minutes: 2297

- When an FGA service arranged for terminating calling only is provided where terminating access minutes are not recorded, the terminating access minutes will be assumed, and no originating access minutes will apply.

Assumed Average Terminating Access Minutes: 1779

- When any or all of the usage over an unmeasured FGA line originates from or terminates to a WATS Access Line and the total FGA usage recorded at the WATS Service Office exceeds the assumed usage set forth preceding for FGA, the recorded usage will be billed to the customer in lieu of the assumed usage.

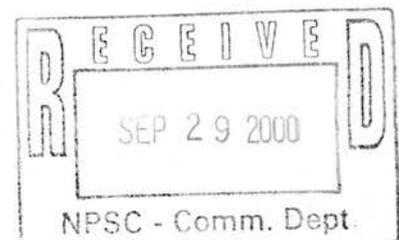

6. SWITCHED ACCESS SERVICE

6.7 RATE TERMS AND CONDITIONS

6.7.7 MEASURING ACCESS MINUTES (Cont'd)

A. Feature Group A Usage Measurement

For originating calls over FGA, usage measurement begins when the originating FGA entry switch receives an off-hook supervisory signal forwarded from the customer's point of termination. (Where FGA is used for resale, this off-hook signal is generally provided by the customer's equipment. Where FGA is not used for resale, the off-hook signal is generally forwarded by the customer's equipment when the called party answers.)

The measurement of originating call usage over FGA ends when the originating FGA entry switch receives an on-hook supervisory signal from either the originating end user's end office, indicating the originating end user has disconnected, or the customer's point of termination, whichever is recognized first by the entry switch.

For terminating calls over FGA, usage measurement begins when the terminating FGA entry switch receives an off-hook supervisory signal from the terminating end user's end office, indicating the terminating end user has answered. The measurement of terminating call usage over FGA ends when the terminating FGA entry switch receives an on-hook supervisory signal from either the terminating end user's end office, indicating the terminating end user has disconnected, or the customer's point of termination, whichever is recognized first by the entry switch.

B. Feature Group B Usage Measurement

For originating calls over FGB, usage measurement begins when the originating FGB entry switch receives answer supervision forwarded from the customer's point of termination, indicating that the customer's equipment has answered.

The measurement of originating call usage over FGB ends when the originating FGB entry switch receives disconnect supervision from either the originating end user's end office, indicating the originating end user has disconnected, or the customer's point of termination, whichever is recognized first by the entry switch.

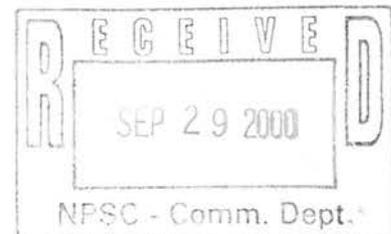

NOTICE

THE INFORMATION CONTAINED IN THIS DOCUMENT IS SUBJECT TO CHANGE.
NE2000-054

6. SWITCHED ACCESS SERVICE

6.7 RATE TERMS AND CONDITIONS

6.7.7 MEASURING ACCESS MINUTES

B. Feature Group B Usage Measurement (Cont'd)

For terminating calls over FGB, usage measurement begins when the terminating FGB entry switch receives answer supervision from the terminating end user's end office, indicating the terminating end user has answered.

The measurement of terminating call usage over FGB ends when the terminating FGB entry switch receives disconnect supervision from either the terminating end user's end office, indicating the terminating end user has disconnected, or the customer's point of termination, whichever is recognized first by the entry switch.

C. Feature Group C Usage Measurement

For originating calls over FGC, if measurement capabilities are not available, usage measurement begins when the originating FGC entry switch receives answer supervision from the customer's point of termination, indicating the called party has answered. If measurement capabilities are available, usage measurement begins when the originating FGC entry switch receives the first wink supervisory signal forwarded from the customer's point of termination.

The measurement of originating call usage over FGC ends when the originating FGC entry switch receives disconnect supervision from either the originating end user's end office, indicating the originating end user has disconnected, or the customer's point of termination, whichever is recognized first by the entry switch.

For terminating calls over FGC to services other than 800/800-type or Voice DA, terminating FGC usage may not be directly measured at the terminating entry switch, but may be imputed from originating usage, excluding usage from calls to 8XX or Voice DA Services. Actual measured usage will be used where available rather than an imputed value.

For terminating calls over FGC to 800/800-type service, usage measurement begins when the terminating FGC entry switch receives answer supervision from the terminating end users end office, indicating the terminating end user has answered.

The measurement of terminating call usage over FGC to 800/800-type service ends when the terminating FGC entry switch receives an on-hook supervisory signal from the terminating end user's end office, indicating the terminating end user has disconnected, or from the customer's point of termination, whichever is recognized first by the entry switch.

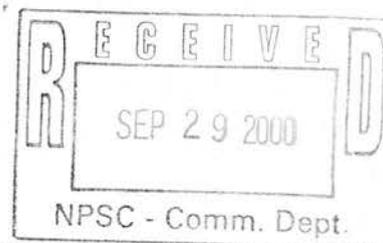

NOTICE

THE INFORMATION CONTAINED IN THIS DOCUMENT IS SUBJECT TO CHANGE.
NE2000-054

6. SWITCHED ACCESS SERVICE

6.7 RATE TERMS AND CONDITIONS

6.7.7 MEASURING ACCESS MINUTES (Cont'd)

D. Feature Group D Usage Measurement

1. Originating Usage Measurement

a. Multifrequency Signaling

For originating calls over FGD, usage measurement begins when the originating FGD entry switch receives the first wink supervisory signal forwarded from the customer's point of termination.

The measurement of originating call usage over FGD ends when the originating FGD entry switch receives disconnect supervision from either the originating end user's end office, indicating the originating end user has disconnected, or the customer's point of termination, whichever is recognized first by the entry switch.

b. SS7 Out of Band Signaling

For originating calls over FGD, usage measurement on direct trunks begins when the FGD entry switch sends an Initial Address Message (IAM). The usage measurement for tandem trunks begins when the FGD entry switch receives an Exit Message (EXM).

The measurement of originating call usage over FGD with SS7 Out of Band Signaling ends when a Release Message is sent or received by the originating end user's end office, whichever occurs first.

2. Terminating Usage Measurement

For terminating calls over FGD, the measurement of access minutes begins when the terminating FGD entry switch receives answer supervision from the terminating end user's end office, indicating the terminating end user has answered.

The measurement of terminating call usage over FGD ends when the terminating FGD entry switch receives disconnect supervision from either the terminating end user's end office, indicating the terminating end user has disconnected, or the customer's point of termination, whichever is recognized first by the entry switch.

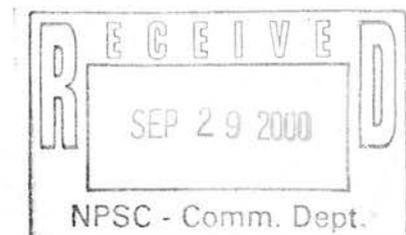

NOTICE

THE INFORMATION CONTAINED IN THIS DOCUMENT IS SUBJECT TO CHANGE.
NE2000-054

6. SWITCHED ACCESS SERVICE

6.7 RATE TERMS AND CONDITIONS (Cont'd)

6.7.8 APPLICATION OF RATES FOR EXTENSION SERVICE

Feature Group A Switched Access Service is available with extensions, i.e., additional terminations of the service at different building(s) in the same or different exchange or in the same or a different LATA. The extensions are charged for under the Company's Private Line Transport Services Catalog.

6.7.9 MESSAGE UNIT CREDIT

Calls from end users to the seven digit local telephone numbers associated with Feature Group A Switched Access Service may be subject to Exchange and Network Services Catalog charges (including message unit and toll charges as applicable), as well as any other applicable charges for the Access Service. The monthly bills rendered to customers for their Feature Group A Switched Access Service for which Carrier Common Line charges apply will include a credit to reflect any message unit charges collected from their end users under the Exchange and Network Services Catalog. The credit will apply for recorded originating usage or for assumed originating usage, as appropriate, for the FGA service provided. When the credit is applied on assumed usage, such credit will not exceed the assumed levels of usage set forth in 6.7.7, preceding. No Message Unit Credit will apply for any terminating FGA access minutes. The Message Unit Credit for originating FGA access minutes is set forth in 6.8, following.

6.7.10 LOCAL INFORMATION DELIVERY SERVICES

Calls over Switched Access in the terminating direction to certain community information services will be rated under the applicable rates for Switched Access Service as set forth in 6.8, following. In addition, non-access charges will also apply in accordance with the Information Provider's applicable service rates when the Company performs the billing function for that Information Provider.

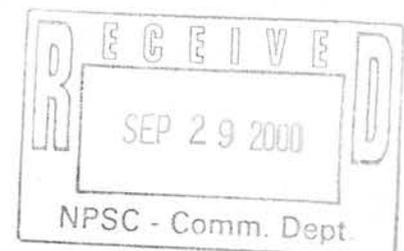

Qwest Corporation
Access Service
Catalog

SECTION 6

Page 129

Release 1

Effective: 9-29-2000

State of Nebraska
Notified: 9-29-2000

6. SWITCHED ACCESS SERVICE

6.7 RATE TERMS AND CONDITIONS (Cont'd)

6.7.11 MILEAGE MEASUREMENT

The mileage to be used to determine the Switched Transport rate for direct routed traffic via DTT is calculated on the airline distance between the end office switch, or the SWC of a Mobile Telephone Switching Office (MTSO), where the call originates or terminates and the customer's SWC. For tandem routed traffic, DTT is calculated from the access tandem to the customer's SWC and TST is calculated on the airline distance between the end office switch, or the SWC of a MTSO, where the call originates or terminates and the access tandem. Exceptions for mileage measurement are as set forth following. The V&H coordinates method is used to determine mileage. This method is set forth in the National Exchange Carrier Association, Inc. Tariff F.C.C. No. 4 for Wire Center Information (V & H coordinates).

Mileage is shown in 6.8, following, in terms of mileage bands. To determine the rate to be billed, first compute the mileage, using the V & H coordinates method; then, find the band into which the computed mileage falls, and apply the rate shown for that band. If the calculation results in a fraction of a mile, always round up to the next whole mile before determining the mileage band and applying the rates.

Exceptions to the mileage measurement rules are as follows:

- A. Mileage for Lineside Switched Access provided by DTT in the originating direction is calculated on an airline basis, using the V & H coordinates method, between the end office switch where the Lineside switching dial-tone is provided and the customer's SWC for the Switched Access Service provided.

Mileage for Lineside Switched Access provided by DTT in the terminating direction is calculated on an airline basis, using V & H coordinates method, between the end office switch where the Lineside switching dial-tone is provided and the customer's SWC when traffic is terminated in the dial-tone office or an end office without measurement capability. When traffic is terminated in an end office with measurement capability and is not the dial-tone office, Tandem Transmission rates are applicable as set forth in 6.7.1, preceding, and mileage will be calculated between the dial-tone office and the end office where the traffic terminates for the application of Tandem Transmission rates. The Tandem Transmission rates are in addition to the DTT rates.

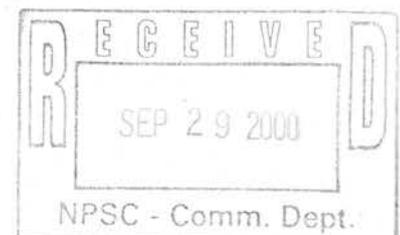

NOTICE

THE INFORMATION CONTAINED IN THIS DOCUMENT IS SUBJECT TO CHANGE.
NE2000-054

Qwest Corporation
Access Service
Catalog

SECTION 6

Page 130

Release 1

State of Nebraska
Notified: 9-29-2000

Effective: 9-29-2000

6. SWITCHED ACCESS SERVICE

6.7 RATE TERMS AND CONDITIONS

6.7.11 MILEAGE MEASUREMENT (Cont'd)

- B. When the customer orders Access Service via DTT to a host for access to a remote switching system or module (RSS or RSM), both DTT and Tandem Transmission rates apply as set forth in 6.7.1, preceding. Mileage for DTT is calculated on an airline basis between the SWC of the customer's premises or Company Hub, whichever is applicable, and the host office for the RSS or RSM. Mileage for Tandem Transmission is calculated between the host office and the RSS or RSM.

When the customer orders TST from an access tandem to a host for access to a RSS or RSM, mileage for Tandem Transmission is calculated between the access tandem and the host office and then a second mileage measurement is calculated between the host office and the RSS or RSM.

- C. When the Switched Transport for Switched Access Service is provided by the Company and the end user connection is provided by a Commercial Mobile Radio Service provider, mileage for Access will be calculated on an airline basis, using the V & H coordinates method as set forth in this section based on tandem or direct routing. The SWC of the MTSO functions as the end office for mileage calculations.
- D. When jointly provisioned Switched Access Service is provided between the Company and another Exchange Telephone Company in conjunction with 800 DB Access Service and ANI cannot be identified, the Company and the other Exchange Telephone Company will mutually agree upon an end office designation to determine an existing end office that reflects the closest mileage measurement to the average Switched Transport miles. This end office designation can then be used for purposes of determining the appropriate mileage by using the V&H coordinates method. When the ANI can be determined, the originating end office will be used to determine the Switched Transport mileage.

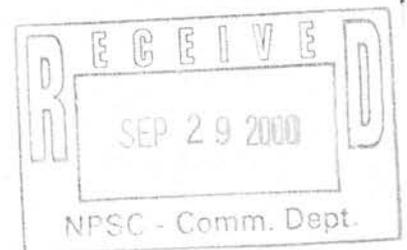

NOTICE

THE INFORMATION CONTAINED IN THIS DOCUMENT IS SUBJECT TO CHANGE.
NE2000-054

Qwest Corporation
Access Service
Catalog

SECTION 6

Page 131

Release 1

Effective: 9-29-2000

State of Nebraska
Notified: 9-29-2000

6. SWITCHED ACCESS SERVICE

6.7 RATE TERMS AND CONDITIONS

6.7.11 MILEAGE MEASUREMENT (Cont'd)

- E. When DTT Switched Transport facilities of different capacities or bandwidths are connected by a multiplexer at a Company Hub, mileage is determined using the V & H coordinates method. Mileage for DTT is measured separately from the SWC to the Company Hub where multiplexing occurs and then measured from the Company Hub to the end office.
- F. When DTT is provided from the SWC to an access tandem in conjunction with TST to subtending end offices, the mileage is determined using the V & H coordinates method. Mileage for DTT is measured between the SWC and the access tandem and mileage for TST is measured from the access tandem to the end offices.
- G. Mileage Measurement for Switched Transport connected to Expanded Interconnection (EI) Service is determined as follows:
- If the EI Service and the access tandem are in the same wire center building, the zero mileage band is used for the transport between the EI Service and the access tandem. Mileage measurement for TST from the access tandem to subtending end offices not located in the same wire center building as the access tandem is calculated using the V&H coordinates method. If the subtending end office is in the same wire center building, a zero mileage band applies.
 - Mileage measurement for DTT is calculated using the V&H coordinates method between the EI Service wire center building and the access tandem when the EI Service and access tandem are in different wire center buildings.
 - Mileage measurement for DTT between the EI Service and the end office when the DTT connects to EI Service in the same wire center building as the end office is a zero mileage band. When the end office is not located in the same wire center building, mileage measurement is calculated using the V&H coordinates method.

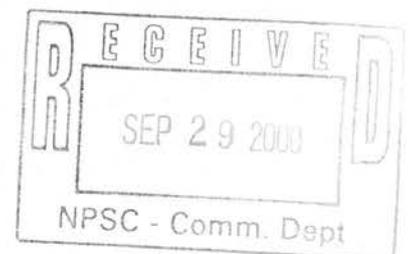

Qwest Corporation
Access Service
Catalog

SECTION 6
Page 132
Release 2

State of Nebraska
Notified: 02-05-2001

Effective: 02-15-2001

6. SWITCHED ACCESS SERVICE

6.7 RATE TERMS AND CONDITIONS (Cont'd)

6.7.12 SHARED USE

The regulations governing the provision of Shared Use facilities are set forth in 2.7, preceding.

(D)

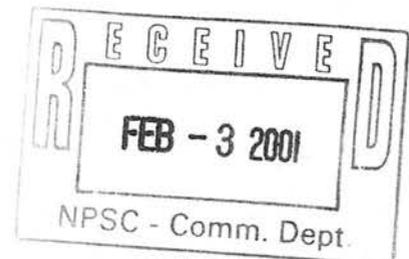

6. SWITCHED ACCESS SERVICE

6.7 RATE TERMS AND CONDITIONS (Cont'd)

6.7.14 PERCENT DIRECT ROUTED (PDR) FACTOR

When the customer orders Trunkside Switched Access Service, and the Company is unable to determine routing based on the call detail, the Company apportions usage between TST and DTT based on a state PDR factor. The PDR factor determines the percentage of traffic to be billed TST rates. DTT monthly rates will not be apportioned by the PDR factor.

The Company calculates the PDR factor in the following manner:

Step 1: The Company obtains the total billed usage for all Switched Access Services on a state-wide basis.

Step 2: The Company obtains the total billed usage for all Switched Access Services utilizing TST on a state-wide basis.

Step 3: The percentage of TST traffic is obtained by dividing the total TST billed usage obtained in Step 2 by the total billed usage in Step 1.

Step 4: The percentage in Step 3 is subtracted from 100 to determine the percentage of DTT traffic (PDR factor).

Step 5: The percentage in Step 3 is multiplied by the total number of access minutes that the Company was unable to determine routing for in that specific state.

This PDR factor will serve as the basis for billing until a revised PDR factor is calculated annually based on the previous year's usage.

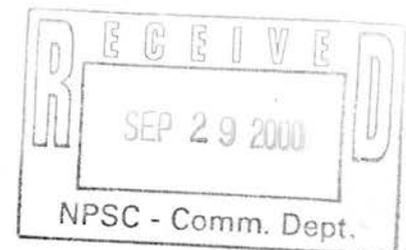

Qwest Corporation d/b/a CenturyLink QC

**Access Service
Catalog**

SECTION 6

Page 134

Release 7

State of Nebraska
Notified: 03-20-2017

Effective: 03-31-2017

6. SWITCHED ACCESS SERVICE

6.8 RATES AND CHARGES

6.8.1 SWITCHED TRANSPORT

A. Entrance Facility Rates

1. Electrical Interface

Voice Grade,
per point of termination

	NONRECURRING CHARGE	MONTHLY RATE	(T)
	\$99.00	\$51.35	(T)

DS1& DS3[1],
per point of termination

	NONRECURRING CHARGE			
	ZONE 1	ZONE 2	ZONE 3	(T)
• Per DS1	\$313.25	\$313.25	\$313.25	(T)
• Per DS3	\$313.25	\$313.25	\$313.25	(T)

		MONTHLY RATE					
		ZONE 1	ZONE 2	ZONE 3			
• DS1 Per point of termination	\$	84.80	\$	92.18	\$	99.55	(T)
• DS3 Per point of termination		1,083.53	1,083.53	1,083.53			(T)

2. Optical Interface[2]

• DS3, per DS3			MONTHLY RATE	(T)
			\$619.68	(T)

[1] Rates and charges for Zones 1, 2 and 3 apply as set forth in 3.7, preceding.

[2] For Shared Use only as set forth in 2.7, preceding.



NOTICE

THE INFORMATION CONTAINED IN THIS DOCUMENT IS SUBJECT TO CHANGE.

Qwest Corporation d/b/a CenturyLink QC

**Access Service
Catalog**

SECTION 6

Page 135

Release 7

State of Nebraska

Notified: 03-20-2017

Effective: 03-31-2017

6. SWITCHED ACCESS SERVICE

6.8 RATES AND CHARGES

6.8.1 SWITCHED TRANSPORT (Cont'd)

B. Direct-Trunked Transport Rates

**1. Voice Grade:
Mileage Bands**

	MONTHLY RATE		
	FIXED	PER MILE	
0	-	-	(T)
Over 0 to 8	\$20.86	\$0.27	
Over 8 to 25	21.28	0.15	
Over 25 to 50	20.37	0.13	
Over 50	24.46	0.29	

**2. DS1:
Mileage Bands**

	MONTHLY RATE[1]			
	ZONE 1	ZONE 2	ZONE 3	
• 0				(T)
- Fixed	-	-	-	(T)
- Per Mile	-	-	-	
• Over 0 to 8				(T)
- Fixed	\$45.27	\$45.27	\$45.27	(T)
- Per Mile	6.85	6.85	6.85	
• Over 8 to 25				(T)
- Fixed	57.70	57.70	57.70	(T)
- Per Mile	7.23	7.23	7.23	
• Over 25 to 50				(T)
- Fixed	62.71	62.71	62.71	(T)
- Per Mile	7.55	7.55	7.55	
• Over 50				(T)
- Fixed	69.05	69.05	69.05	(T)
- Per Mile	7.92	7.92	7.92	

[1] Rates and charges for Zones 1, 2 and 3 apply as set forth in 3.7, preceding.

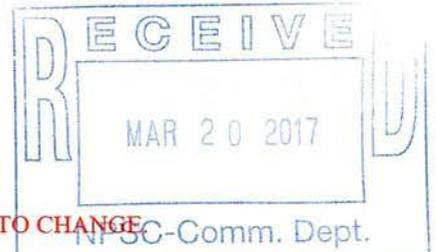

Qwest Corporation d/b/a CenturyLink QC
Access Service
Catalog

SECTION 6
 Page 135.1
 Release 2
 Effective: 03-31-2017

State of Nebraska
 Notified: 03-20-2017

6. SWITCHED ACCESS SERVICE

6.8 RATES AND CHARGES

6.8.1 SWITCHED TRANSPORT

B. Direct-Trunked Transport Rates (Cont'd)

3. DS3
 Mileage Bands

	MONTHLY RATE[1]			
	ZONE 1	ZONE 2	ZONE 3	(T)
• 0				(T)
- Fixed	-	-	-	
- Per Mile	-	-	-	
• Over 0 to 8				(T)
- Fixed	\$186.43	\$186.43	\$186.43	
- Per Mile	38.70	38.70	38.70	
• Over 8 to 25				(T)
- Fixed	201.77	201.77	201.77	
- Per Mile	24.95	24.95	24.95	
• Over 25 to 50				(T)
- Fixed	219.84	219.84	219.84	
- Per Mile	25.47	25.47	25.47	
• Over 50				(T)
- Fixed	264.88	264.88	264.88	
- Per Mile	32.12	32.12	32.12	

[1] Rates and charges for Zones 1, 2 and 3 apply as set forth in 3.7, preceding.



Qwest Corporation d/b/a CenturyLink QC

**Access Service
Catalog**

SECTION 6

Page 136

Release 11

State of Nebraska
Notified: 06-18-2021

Effective: 07-01-2021

6. SWITCHED ACCESS SERVICE

6.8 RATES AND CHARGES

6.8.1 SWITCHED TRANSPORT (Cont'd)

C. Tandem-Switched Transport Usage Rates

1. Zones 1, 2 and 3

MILEAGE BANDS	RATE PER ACCESS MINUTE	
	FIXED	PER MILE
a. Tandem Transmission		
• Originating– Non-8YY *		
0	–	–
Over 0 to 8	\$0.000360	\$0.000096
Over 8 to 25	0.000461	0.000054
Over 25 to 50	0.000476	0.000034
Over 50	0.000479	0.000030
• Terminating – Tandem 3rd Party		
0	–	–
Over 0 to 8	\$0.000240	\$0.000030
Over 8 to 25	0.000240	0.000030
Over 25 to 50	0.000240	0.000030
Over 50	0.000240	0.000030
• Terminating – Tandem End Office		
0	–	–
Over 0 to 8	\$0.000000	\$0.000000
Over 8 to 25	0.000000	0.000000
Over 25 to 50	0.000000	0.000000
Over 50	0.000000	0.000000

(C)

* Effective July 1, 2021, pursuant to FCC 20-143, separate rate elements for 8YY and Non-8YY originating transport services were established. The Non-8YY originating elements are displayed above. The originating 8YY rate element for transport services is displayed as 8YY Joint Tandem Switched Transport in Section 6.8.1(C)(1), following.

(N)

(N)

Qwest Corporation d/b/a CenturyLink QC

**Access Service
Catalog**

SECTION 6

Page 136.1

Release 3

State of Nebraska

Notified: 06-18-2021

Effective: 07-01-2021

6. SWITCHED ACCESS SERVICE

6.8 RATES AND CHARGES

6.8.1 SWITCHED TRANSPORT

C. Tandem-Switched Transport Usage Rates

1. Zones 1, 2 and 3 (Cont'd)

	RATE PER ACCESS MINUTE	
b. Tandem Switching Charge		
• Originating– Non-8YY *	\$0.004912	(T)
• Terminating – Tandem 3rd Party	\$0.002252	
• Terminating – Tandem End Office	\$0.000000	
c. Common Transport Multiplexing		
• Originating– Non-8YY *	\$0.000073	(T)
• Terminating - Tandem 3rd Party	\$0.000036	
• Terminating - Tandem End Office	\$0.000000	
d. 8YY Joint Tandem Switched Transport		(N)
• Originating – 8YY *	\$0.001	(N)
	MONTHLY RATE	
e. Access Tandem Trunk Port Charge, per port	\$6.00	(T)

* Effective July 1, 2021, pursuant to FCC 20-143, separate rate elements for 8YY and Non-8YY originating transport services were established. The originating 8YY rate element for transport services is displayed as 8YY Joint Tandem Switched Transport in Section 6.8.1(C)(1), above. (N)

|
(N)

Qwest Corporation d/b/a CenturyLink QC

Access Service
Catalog

SECTION 6

Page 137

Release 4

State of Nebraska

Notified: 03-20-2017

Effective: 03-31-2017

6. SWITCHED ACCESS SERVICE

6.8 RATES AND CHARGES

6.8.1 SWITCHED TRANSPORT (Cont'd)

D. Nonrecurring Charges

	NONRECURRING CHARGE	(T)
1. Line or Trunk Installation		
• Interface Groups 1 and 2		
- First line or trunk	\$446.82	(T)
- Each additional line or trunk	77.40	(T)
• Interface Group 6		
- First line or trunk	412.28	(T)
- Each additional line or trunk	42.64	(T)
• Interface Group 9		
- First line or trunk	409.32	(T)
- Each additional line or trunk	40.34	(T)

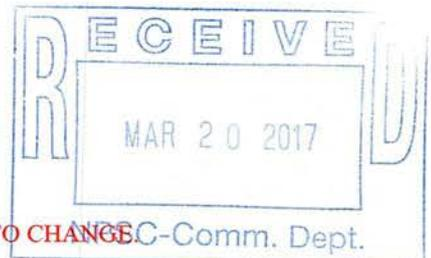

NOTICE

THE INFORMATION CONTAINED IN THIS DOCUMENT IS SUBJECT TO CHANGE

Qwest Corporation d/b/a CenturyLink QC
Access Service
Catalog

SECTION 6
Page 138
Release 4
Effective: 03-31-2017

State of Nebraska
Notified: 03-20-2017

6. SWITCHED ACCESS SERVICE

6.8 RATES AND CHARGES
6.8.1 SWITCHED TRANSPORT
D. Nonrecurring Charges (Cont'd)

	NONRECURRING CHARGE	(T)
2. Moves within the Same Serving Wire Center		
• Switched Access Service, per line or trunk associated with Interface Groups 1 and 2		
- First line or trunk	\$318.17	(T)
- Each additional line or trunk	32.42	(T)
• Switched Access Service, per line or trunk associated with Interface Group 6		
- First line or trunk	297.41	(T)
- Each additional line or trunk	10.43	(T)
• Switched Access Service, per line or trunk associated with Interface Group 9		
- First line or trunk	296.17	(T)
- Each additional line or trunk	9.10	(T)

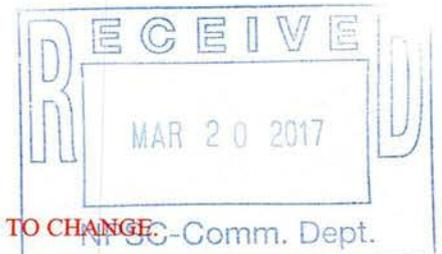

Qwest Corporation d/b/a CenturyLink QC
Access Service
Catalog

SECTION 6
Page 139
Release 4

State of Nebraska
Notified: 03-20-2017

Effective: 03-31-2017

6. SWITCHED ACCESS SERVICE

6.8 RATES AND CHARGES
6.8.1 SWITCHED TRANSPORT

D. Nonrecurring Charges (Cont'd)

	NONRECURRING CHARGE	(T)
3. Moves to a Different Serving Wire Center		
• Switched Access Service, per line or trunk associated with Interface Groups 1 and 2		
- First line or trunk	\$369.87	(T)
- Each additional line or trunk	49.14	(T)
• Switched Access Service, per line or trunk associated with Interface Group 6		
- First line or trunk	335.00	(T)
- Each additional line or trunk	12.16	(T)
• Switched Access Service, per line or trunk associated with Interface Group 9		
- First line or trunk	332.65	(T)
- Each additional line or trunk	9.68	(T)

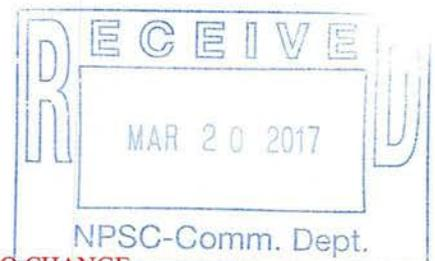

Qwest Corporation d/b/a CenturyLink QC
Access Service
Catalog

SECTION 6
Page 140
Release 4
Effective: 03-31-2017

State of Nebraska
Notified: 03-20-2017

6. SWITCHED ACCESS SERVICE

6.8 RATES AND CHARGES

6.8.1 SWITCHED TRANSPORT

D. Nonrecurring Charges (Cont'd)

4. Service Rearrangement

a. SS7 Out of Band Signaling

(1) Service Order Rearrangement Charge

	NONRECURRING CHARGE	(T)
• One-way to SS7 FGD two-way	\$ 97.72	(T)
• Two-way to SS7 FGD two-way	97.72	(T)
(2) SS7 Trunk Rearrangement Charge		
(a) One-way to SS7 FGD two-way		
• Per first trunk in a SS7 trunk group		
- Interface Groups 1 and 2	180.34	(T)
- Interface Group 6	176.44	(T)
- Interface Group 9	176.44	(T)
• Per each additional trunk in a SS7 trunk group		
- Interface Groups 1 and 2	15.18	(T)
- Interface Group 6	11.28	(T)
- Interface Groups 9	11.28	(T)



Qwest Corporation d/b/a CenturyLink QC

Access Service
Catalog

SECTION 6

Page 141

Release 4

State of Nebraska
Notified: 03-20-2017

Effective: 03-31-2017

6. SWITCHED ACCESS SERVICE

6.8 RATES AND CHARGES

6.8.1 SWITCHED TRANSPORT

D. Nonrecurring Charges

4. Service Rearrangement

a. SS7 Out of Band Signaling

(2) SS7 Trunk Rearrangement Charge (Cont'd)

(b) Two-way to SS7 FGD two-way

	NONRECURRING CHARGE	(T)
• Per first trunk in a SS7 trunk group		
- Interface Groups 1 and 2	\$152.81	(T)
- Interface Group 6	148.91	(T)
- Interface Group 9	148.91	(T)
• Per each additional trunk in a SS7 trunk group		
- Interface Groups 1 and 2	12.39	(T)
- Interface Groups 6	8.50	(T)
- Interface Group 9	8.50	(T)
b. FGD Service with SS7 out of band signaling to FGD Service with SS7 Out of Band Signaling and Clear Channel Capability		
• Per first trunk		
- Interface Group 6	206.14	(T)
- Interface Group 9	204.66	(T)
• Per each additional trunk		
- Interface Group 6	22.44	(T)
- Interface Group 9	21.23	(T)



Qwest Corporation d/b/a CenturyLink QC

**Access Service
Catalog**

SECTION 6

Page 141.1

Release 2

State of Nebraska

Notified: 03-20-2017

Effective: 03-31-2017

6. SWITCHED ACCESS SERVICE

6.8 RATES AND CHARGES

6.8.1 SWITCHED TRANSPORT

D. Nonrecurring Charges

4. Service Rearrangement (Cont'd)

	NONRECURRING CHARGE	(T)
c. FGB or FGD Tandem to Direct Routed Access		
• Per first trunk in a Direct Routed Trunk Group		
- Interface Groups 1 and 2	\$156.39	(T)
- Interface Group 6	144.30	(T)
- Interface Group 9	143.26	(T)
• Per each additional trunk in a Direct Routed Trunk Group		
- Interface Groups 1 and 2	27.09	(T)
- Interface Group 6	15.71	(T)
- Interface Group 9	14.86	(T)
d. Rollover Charges		
• Voice Grade, per termination	\$57.76	(T)
	NONRECURRING CHARGE[1]	
	ZONE 1 ZONE 2 ZONE 3	(T)
• DS1 to DS3, Per DS1 or DS3 Termination	\$122.50 \$122.50 \$122.50	(T)

[1] Rates and charges for Zones 1, 2 and 3 apply as set forth in 3.7, preceding.

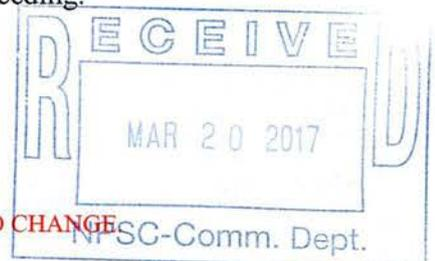

NOTICE

THE INFORMATION CONTAINED IN THIS DOCUMENT IS SUBJECT TO CHANGE

NE2017-001

Qwest Corporation d/b/a CenturyLink QC
Access Service
Catalog

SECTION 6
Page 142
Release 3
Effective: 03-31-2017

(C)

State of Nebraska
Notified: 03-20-2017

6. SWITCHED ACCESS SERVICE

6.8 RATES AND CHARGES
6.8.1 SWITCHED TRANSPORT (Cont'd)

E. Optional Features

1. Multiple POTs Tandem Sectorization (MPTS)

	NONRECURRING CHARGE	(T)
• MPTS ASR (without associated trunk activity), per ASR	\$ 48.71	(T)
• MPTS Establishment (without associated trunk activity)		
- Per FGC sector	323.25	(T)
- Per FGD sector	188.86	(T)
• MPTS Establishment (with associated trunk activity)		
- Per FGC sector	323.25	(T)
- Per FGD sector	188.86	(T)
• MPTS Rearrangement (without associated trunk activity)		
- Per FGC sector	47.25	(T)
- Per FGD sector	32.55	(T)
• MPTS Rearrangement (with associated trunk activity)		
- Per FGC sector	47.25	(T)
- Per FGD sector	32.55	(T)

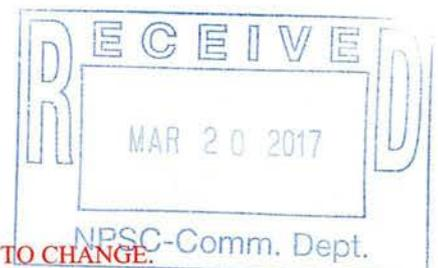

Qwest Corporation d/b/a CenturyLink QC
Access Service
Catalog

SECTION 6
Page 143
Release 2
Effective: 03-31-2017

(C)

State of Nebraska
Notified: 03-20-2017

6. SWITCHED ACCESS SERVICE

6.8 RATES AND CHARGES
6.8.1 SWITCHED TRANSPORT
E. Optional Features (Cont'd)

2. Customer specification of the receive transmission level at the first point of switching within a range acceptable to the Company, per line or trunk[1]
3. Customer specification of Local Transport Termination four-wire termination in lieu of two-wire termination, per line or trunk[2]

(D)

(T)

(T)

[1] Available with Interface Groups 2, 6 and 9. The range of transmission levels which may be specified is described in Technical Reference GR-334-CORE.

[2] Available with Feature Group B.



Qwest Corporation d/b/a CenturyLink QC

**Access Service
Catalog**

**SECTION 6
Page 144
Release 7**

State of Nebraska
Notified: 03-20-2017

Effective: 03-31-2017

6. SWITCHED ACCESS SERVICE

6.8 RATES AND CHARGES
6.8.1 SWITCHED TRANSPORT
E. Optional Features (Cont'd)

4. Multiplexing[1]

	NONRECURRING CHARGE[2]			
	ZONE 1	ZONE 2	ZONE 3	
• Entrance Facility, - Per DS1 to VG				(T)
	\$ 75.00	\$ 75.00	\$ 75.00	(T)
- Per DS3 to DS1	200.00	200.00	200.00	(T)
• DTT Facility, per Arrangement - Per DS1 to VG				
	75.00	75.00	75.00	(T)
- Per DS3 to DS1	200.00	200.00	200.00	(T)
	MONTHLY RATE			
	ZONE 1	ZONE 2	ZONE 3	
• Entrance Facility, per Arrangement - DS1 to VG,				
	\$199.98	\$199.98	\$199.98	(T)
- DS3 to DS1,	252.37	252.37	252.37	(T)
• DTT Facility, per Arrangement - DS1 to VG,				
	199.98	199.98	199.98	(T)
- DS3 to DS1,	252.37	252.37	252.37	(T)

[1] Rates and charges for Zones 1, 2 and 3 apply as set forth in 3.7, preceding.
[2] Nonrecurring charges apply when the MUX is not installed at the same time as an Entrance Facility or a DTT facility.

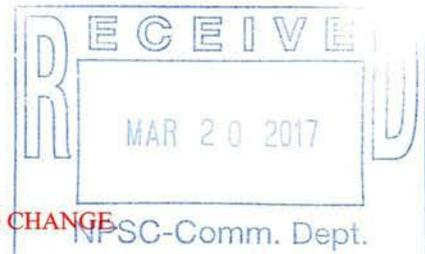

Qwest Corporation d/b/a CenturyLink QC

Access Service Catalog

SECTION 6

Page 145

Release 15

State of Nebraska

Notified: 06-16-2023

Effective: 07-01-2023

6. SWITCHED ACCESS SERVICE

6.8 RATES AND CHARGES (Cont'd)

6.8.2 LOCAL SWITCHING

A. Local End Office Switching

	RATE PER ACCESS MINUTE
• Originating- 8YY	\$0.000000 (R)
• Originating- Non-8YY	\$0.003951
• Terminating	0.000000
• End Office Shared Port	
- Originating- 8YY	\$0.000000 (R)
- Originating- Non-8YY	\$0.001494
- Terminating	0.000000
	MONTHLY RATE
• End Office Dedicated Trunk Port,[1] per trunk	\$3.00
	RATE
• 800 DB Access Service	
- 800 CIC, per call	\$0.0002(R)
- Vertical Features	
- POTS Translation Charge, per call	0.000000
- Call Handling and Destination Feature Charge, per query	0.000000
• 900 Access Service Customer Identification Charge, per call	0.000994

[1] The End Office Dedicated Trunk Port rate was calculated based upon a 50/50 split between originating and terminating traffic using this flat-rated port. The FCC in their FCC 11-161 ICC Transformation order in section 51.907(d)(1) allowed Price Cap Carriers to use an equal split to divide the charge between originating and terminating elements. When the terminating portion of the rate is reduced and then combined with the originating portion of the rate, a single flat rate is generated for billing purposes. The Originating portion of the charge is \$3.00.

Qwest Corporation d/b/a CenturyLink QC
Access Service
Catalog

(C)

SECTION 6
Page 146
Release 2

State of Nebraska
Notified: 03-20-2017

Effective: 03-31-2017

6. SWITCHED ACCESS SERVICE

6.8 RATES AND CHARGES

6.8.2 LOCAL SWITCHING

A. Local End Office Switching (Cont'd)

	NONRECURRING CHARGE	(T)
• 900 Access Service		
- Per first NXX, per End Office/Tandem	\$103.56	(T)
- Per each subsequent NXX, per End Office/Tandem	24.30	(T)
- Expanded 900 Option, per End Office/ Tandem with NXX Activity (available with CST3 and FGD)	890.76	(T)
- Expanded 900 Option, per End Office/ Tandem without NXX Activity (available with CST3 and FGD)	968.22	(T)

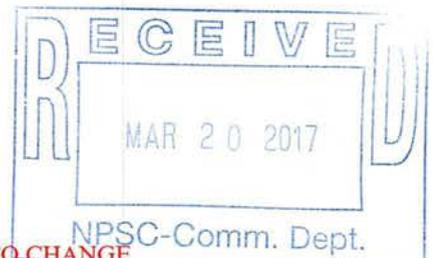

NOTICE

THE INFORMATION CONTAINED IN THIS DOCUMENT IS SUBJECT TO CHANGE.

NE2017-001

Qwest Corporation d/b/a CenturyLink QC
Access Service
Catalog

SECTION 6
Page 147
Release 2
Effective: 03-31-2017

(C)

State of Nebraska
Notified: 03-20-2017

6. SWITCHED ACCESS SERVICE

6.8 RATES AND CHARGES
6.8.2 LOCAL SWITCHING (Cont'd)

B. Common Switching Optional Features

- Call Denial on Line or Hunt Group (available with FGA), per line (D)
- Service Code Denial on Line or Hunt Group (available with FGA), per line (T)
- Hunt Group Arrangement (available with FGA), per line (T)
- Uniform Call Distribution Arrangement (available with FGA), per line (T)
- Nonhunting Number for use with Hunt Group Arrangement or Uniform Call Distribution Arrangement (available with FGA), per line (T)
- Automatic Number Identification (available with FGB, FGC and FGD), per trunk group[1] (T)
- Up to 7-Digit Outpulsing of Access Digits to customer (available with FGB), per trunk group (T)

[1] MF Signaling or SS7 Out of Band Signaling.

Qwest Corporation d/b/a CenturyLink QC
Access Service
Catalog

SECTION 6
Page 148
Release 2

(C)

State of Nebraska
Notified: 03-20-2017

Effective: 03-31-2017

6. SWITCHED ACCESS SERVICE

6.8 RATES AND CHARGES

6.8.2 LOCAL SWITCHING

B. Common Switching Optional Features (Cont'd)

- Cut-Through (available with FGD),
per end office or access tandem (D)
- Delay Dial Start-Pulsing Signaling
(available with FGC), per trunk group[1] (T)
- Immediate Dial Pulse Address Signaling
(available with FGC), per trunk group (T)
- Dial Pulse Address Signaling (available
with FGC), per trunk group (T)
- Revertive Pulse Address Signaling
(available with FGC), per trunk group[1] (T)
- Service Class Routing (available with
FGC and FGD), per trunk group (T)
- Alternate Traffic Routing (available with
FGB, FGC and FGD), per trunk group (T)
- Multiple Customer Premises Alternate
Routing (available with FGB, FGC and
FGD), per trunk group (T)
- End Office Alternate Routing when
ordered in trunks (available with FGB,
FGC and FGD)
 - Per trunk
 - Per trunk group (T)

[1] Available with existing services only.

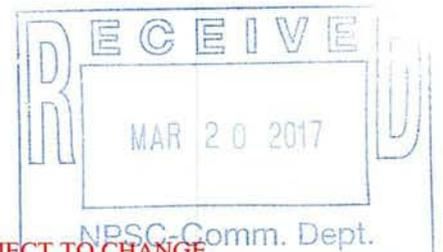

Qwest Corporation d/b/a CenturyLink QC

Access Service
Catalog

SECTION 6
Page 149
Release 3
Effective: 03-31-2017

(C)

State of Nebraska
Notified: 03-20-2017

6. SWITCHED ACCESS SERVICE

6.8 RATES AND CHARGES

6.8.2 LOCAL SWITCHING

B. Common Switching Optional Features (Cont'd)

		(D)
• Trunk Access Limitation Arrangement (available with FGC and FGD), per end office		(T)
• Band Advance for Use with WATS Access Service (available with FGA, FGB, FGC and FGD)		(T)
• Hunt Group for use with WATS Access Service (available with FGA, FGB, FGC and FGD), per hunt group		(T)
• Uniform Call Distribution for use with WATS Access Service (available with FGA, FGB, FGC and FGD), per hunt group		(T)
• Nonhunting Number for use with Hunt Group or Uniform Call Distribution for use with WATS Access Service (available with FGA, FGB, FGC and FGD), per line		(T)
• Feature Group A InterLATA Toll Denial, per line	-	
	NONRECURRING CHARGE	(T)
• Clear Channel Capability (available with FGD), per trunk group[1]	\$12.50	(T)

[1] The flat rated Clear Channel Capability charge was calculated based upon a 50/50 split between originating and terminating. The FCC in their FCC 11-161 ICC Transformation order in section 51.907(d)(1) allowed Price Cap Carriers to use an equal split to divide the charge between originating and terminating elements. When the terminating portion of the rate is reduced and then combined with the originating portion of the rate, a single flat rate is generated for billing purposes.

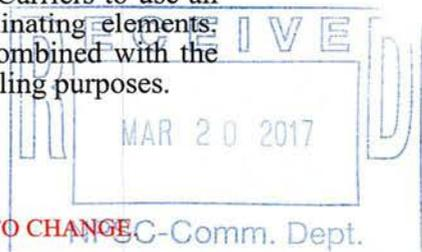

Qwest Corporation d/b/a CenturyLink QC
Access Service
Catalog

SECTION 6
Page 150
Release 2
Effective: 03-31-2017

(C)

State of Nebraska
Notified: 03-20-2017

6. SWITCHED ACCESS SERVICE

6.8 RATES AND CHARGES
6.8.2 LOCAL SWITCHING (Cont'd)

C. Transport Termination Optional Features

1. Lineside Terminations (for FGA)

- Two Way Operation
 - Dial Pulse with Loop Start
 - Dial Pulse with Ground Start
 - DTMF with Loop Start
 - DTMF with Ground Start
- Terminating Operation
 - Dial Pulse with Loop Start
 - Dial Pulse with Ground Start
 - DTMF with Loop Start
 - DTMF with Ground Start
- Originating Operation
 - Loop Start
 - Ground Start

(D)

(T)

(T)

(T)

(T)

(T)

(T)

2. Trunkside Terminations (for FGB, FGC and FGD)

- Standard Trunk for Originating
(available with Trunkside Access)
- Standard Trunk for Terminating
(available with Trunkside Access)
- Standard Trunk for Two-Way
(available with Trunkside Access)
- Operator Trunk, Coin, Non-Coin or Combined
Coin and Non-Coin (available with FGC and FGD)
- Operator Trunk, Full Feature Arrangement
(available with FGD)

(T)

(T)

(T)

(T)

(T)



Qwest Corporation d/b/a CenturyLink QC
Access Service
Catalog

(C)

SECTION 6
Page 151
Release 2
Effective: 03-31-2017

State of Nebraska
Notified: 03-20-2017

6. SWITCHED ACCESS SERVICE

6.8 RATES AND CHARGES

6.8.2 LOCAL SWITCHING (Cont'd)

D. Line Termination Optional Features

1. WATS Access Line Termination Options

(D)

a. Lineside Terminations

• Originating only loop-start, lineside connection, with DTMF address signaling per WATS Access Line

(T)

• Originating only loop-start, lineside connection, with dial-pulse address signaling per WATS Access Line

(T)

• Originating only ground-start, lineside connection, with DTMF address signaling per WATS Access Line

(T)

• Originating only ground start, lineside connection, with dial-pulse address signaling, per WATS Access Line

(T)

• Terminating only loop start, lineside connection, per WATS Access Line

(T)

• Terminating only ground start, lineside connection, per WATS Access Line

(T)

b. Trunkside Terminations

Terminating only trunkside connection for forwarding of Dialed Number Identification to end user, per WATS Access Line

(T)

[1] This revision corrects page release number.

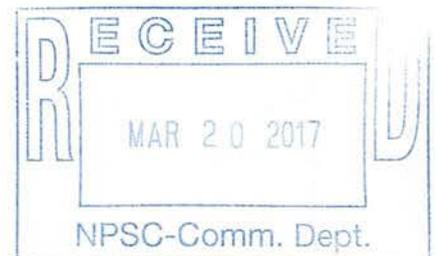

NOTICE

THE INFORMATION CONTAINED IN THIS DOCUMENT IS SUBJECT TO CHANGE.

NE2017-001

Qwest Corporation
Access Service
Catalog

SECTION 6

Page 152

Release 2

State of Nebraska
Notified: 02-05-2001

Effective: 02-15-2001

6. SWITCHED ACCESS SERVICE

6.8 RATES AND CHARGES (Cont'd)

6.8.3 MESSAGE UNIT CREDIT

RATE PER
ORIGINATING FGA
ACCESS MINUTE

- Nebraska

\$(0.00091)[1]

(D)

[1] () Equals a negative amount.

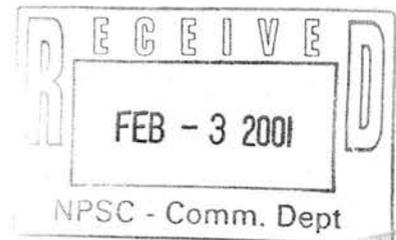

Qwest Corporation
Access Service
Catalog

State of Nebraska
Notified: 9-29-2000

SECTION 7
Index Page 1
Release 1
Effective: 9-29-2000

7. RESERVED FOR FUTURE USE

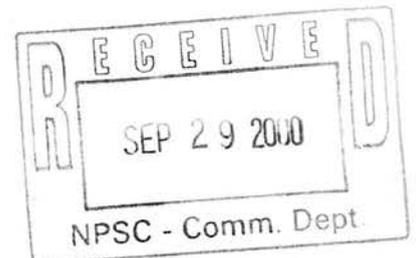

Qwest Corporation
Access Service
Catalog

State of Nebraska
Notified: 7-26-2006

SECTION 8
Index Page 1
Release 4
Effective: 8-7-2006

8. RESERVED FOR FUTURE USE

(C)

SUBJECT

PAGE

(D)

[1] This Sheet also cancels the following: Page 1
Page 2
Page 3

Release 2
Release 2
Release 2

(N)
—
(N)

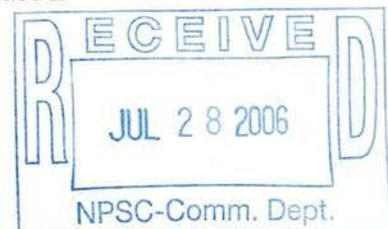

Qwest Corporation
Access Service
Catalog

SECTION 9
Index Page 1
Release 2
Effective:11-01-2002

State of Nebraska
Notified: 10-22-2002

9. DIRECTORY ASSISTANCE SERVICE

SUBJECT	PAGE	
General Description	1	(D)
Obligations of the Customer	6	(T)
Rate Terms and Conditions.....	7	(D)
Rates and Charges.....	10	(T)
Undertaking of the Company	1	(T)
		(D)

9. DIRECTORY ASSISTANCE SERVICE

9.1 GENERAL DESCRIPTION

Directory Assistance Service provides subscriber telephone number information to the requesting customer. Nonpublished subscriber telephone number information is not provided with Directory Assistance Service.

(C)
(D)

Voice Directory Assistance Service provides Directory Access Service to Voice DA locations, use of Voice DA access equipment and use of Voice DA operators to provide telephone numbers.

The Company will provide Voice DA Service to a customer from Voice DA Service locations.

9.2 UNDERTAKING OF THE COMPANY

(D)
(M)

A. General

A Company Voice DA operator, when furnished a name and locality, will provide or attempt to provide the telephone number listed in the Company DA records associated with the name given at the rates and charges as set forth in 9.5, following. The Company's contact with the customer's end user shall be limited to that effort necessary to process a customer's end user's request for a telephone number. The Company will not transfer, forward or redial a customer's end user call to any other location for any purpose other than provision of Voice DA Service.

(T)

A maximum of 2 telephone number requests will be accepted per call to the Voice DA operator. A telephone number that is not listed in DA records will not be available to the customer's end user.

(T)
(T)

(M)

(M) Material moved from Page 2.

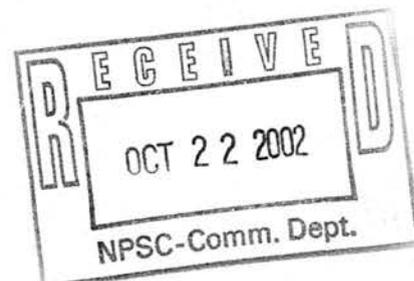

9. DIRECTORY ASSISTANCE SERVICE

9.2 UNDERTAKING OF THE COMPANY (Cont'd)

(D)
(M)

B. Voice DA Locations

The Company will specify the Voice DA location which provides the Voice DA Service for each numbering plan area code (NPA). The Voice DA locations are as shown in the National Exchange Carrier Association, Inc. Tariff F.C.C. No. 4.

When it becomes necessary, as determined by the Company, to change a Voice DA location, the Company will notify the involved customers 6 months prior to the change. For such changes, the terms and conditions as set forth in 2.1.7, preceding, apply.

(T)

Voice DA Service may, at the option of the customer, be provided for interstate and intrastate communications. When the customer requests such mixed access, the intrastate Voice DA Service charges will be determined by the Company using the data furnished by the customer as set forth in 2.3.10, preceding.

Except as set forth in 9.4, following, a Voice DA order is subject to the order conditions as set forth in Section 5, preceding.

(T)

C. Transport Facilities and Manner of Provisioning

(M1)

When Voice DA Service is ordered, a two-way voice frequency transmission path will be provided by the Company to transport calls in the terminating direction (from the premises of the ordering customer to the Voice DA location) utilizing Switched Transport facilities. These facilities include:

- An Entrance Facility for the transport of the Voice DA Service from the customer's premises to the SWC of that premises, as described in 1., following,
- A Direct-Trunked Transport facility between the SWC of the customer's premises and the Voice DA location for direct routed traffic as described in 2., following, or
- A Direct-Trunked Transport facility between the SWC of the customer's premises and the access tandem and Tandem-Switched Transport between the access tandem and the Voice DA location when tandem switching functions are utilized. Tandem-Switched Transport includes the switching functions performed by the access tandem as described in 3., following, and
- Interface Group and Premises Interface Codes as described in 9., following.

(M1)

(M) Material moved to Page 1.

(M1) Material moved from Page 3.

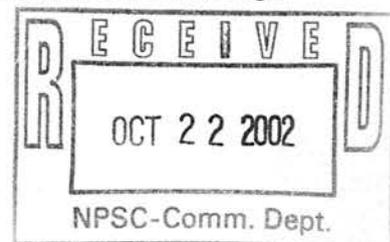

NOTICE

9. DIRECTORY ASSISTANCE SERVICE

9.2 UNDERTAKING OF THE COMPANY

C. Transport Facilities and Manner of Provisioning (Cont'd)

1. The Entrance Facility rate category provides the transport between the customer's premises and the SWC of that premises. The Entrance Facility rate is described in 6.1.2, preceding, and the rates for Entrance Facilities are set forth in 6.8, preceding, based on the facility provided, DS3, DS1 or Voice Grade.
2. Direct-Trunked Transport (DTT) provides for transport from the SWC of the customer's premises to a Voice DA location for traffic requiring no tandem switching. DTT facilities are described in 6.1.2, preceding, and the rates for DTT facilities for Voice DA are set forth in 6.8, preceding, based on the facility provided, DS3, DS1 or Voice Grade.
3. For tandem routed traffic, DTT provides the transport from the SWC of the customer's premises to the access tandem and Tandem-Switched Transport (TST) provides the transmission facilities between the access tandem and the Voice DA location. The DTT rates are as set forth in 2., preceding. The TST rate category is comprised of a Transport Fixed per-call rate, Transport Per-Mile, per-call rate, a Tandem Switching per-call rate, a Common Transport Multiplexing per-call rate and an Access Tandem Trunk Port rate. TST facilities are described in 6.1.2, preceding, and the TST rates for Voice DA are set forth in 9.5, following.
4. For purposes of determining mileage for DTT and TST, distance will be measured to the Voice DA location(s) for Voice DA Service based on the mileage measurement rules as set forth in 6.7.11, preceding.
5. The customer shall request direct routing or tandem routing on the customer's order for service. In addition, the customer shall specify if the Entrance Facility is new or existing. The Company will make the final determination based on facilities, whether the Voice DA Service is to be routed directly to a Voice DA location or through an access tandem switch appropriately equipped for Voice DA measurement and served by Voice DA trunks to the Voice DA location. The combination of Trunkside Switched Access Service with Voice DA Service will only be provided at such available and appropriately equipped access tandem switches. If the customer desires the traffic routing to be other than that selected by the Company, it may request a cooperative effort to determine if customer-specified traffic routing can be used in lieu of the Company-selected traffic routing.

(D)
(T)
(M)

(M1)

(T)

(T)

(M1)

(M) Material moved to Page 2.
(M1) Material moved from Page 4.

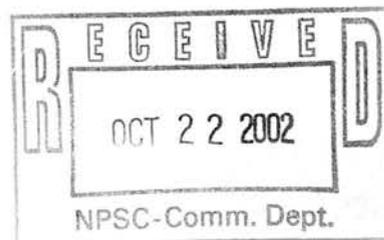

9. DIRECTORY ASSISTANCE SERVICE

9.2 UNDERTAKING OF THE COMPANY

C. Transport Facilities and Manner of Provisioning (Cont'd)

6. When Directory Transport is provided using a direct route to the Voice DA location, no address signaling is provided. When Directory Transport is provided with the use of an access tandem switch, wink start-start pulsing signaling is provided at the access tandem switch. The customer will be notified by the Company when access tandem routing is provided and the customer shall address each call to the Voice DA location using NPA+555-1212, NPA+131, or, when required by the Company, 555-1212. Only NPA codes handled by the Voice DA location served by the access tandem switch will be processed.
7. When required by the Company, a separate trunk group will be provided for Voice DA Service for each NPA. Separate trunk groups will be required when the Company notifies the customer that the mechanized search of its data base and its mechanized operator practices require a mechanized identification of the NPA code for which the customer's end user desires Voice DA information.
8. The number of Directory Transport transmission paths provided is based on the customer's order and is determined by the Company in a manner similar to Switched Access Service transmission paths as set forth in 6.5.7, preceding.
9. Interface Group and Premises Interface Codes

Interface Groups 2, 6 and 9 as set forth in 6.1.2, preceding, are available for Voice DA Service when combined with Trunkside Switched Access Service. When Voice DA Service is combined with Trunkside Switched Access Service via TST, the Premises Interface Code for the combination will be the available Premises Interface Code for the Trunkside Switched Access Service ordered by the customer. When only Voice DA Service is provided, only Interface Groups 2 and 6 are available with the following Premises Interface Codes:

PREMISES
INTERFACE CODE

4DS9-15
6EA2-E
6EA2-M

- (M) Material moved to Page 3.
(M1) Material moved from Page 5.
(M2) Material moved from Page 6.

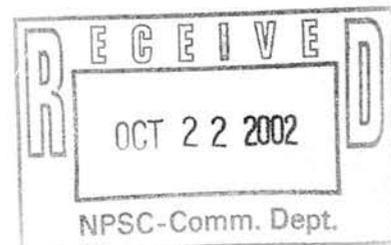

9. DIRECTORY ASSISTANCE SERVICE

9.2 UNDERTAKING OF THE COMPANY (Cont'd)

D. Special Facilities Routing

A customer may request that Voice DA Service be provided via Special Facilities Routing. The terms, conditions, rates and charges for Special Facilities Routing (i.e., Diversity) are as set forth in Section 11, following.

E. Design Layout Report

The Company will provide to the customer the makeup of the facilities and services provided under this section as Voice DA Service. This information will be provided in the form of a Design Layout Report similar to that as set forth in 6.1.4, preceding. Design Layout Reports for Voice DA will be provided only when specifically requested by the customer. The Design Layout Report will be provided to the customer at no charge, and will be reissued or updated whenever the facilities provided for the customer's use are materially changed.

F. Transmission Type A1 and B1 Performance

Voice DA Service is provided with either Transmission Type A1 or B1 performance. The performance associated with the standard transmission parameter limits are guaranteed to the Voice DA location, whether routed directly or via an access tandem. Transmission Type A1 and B1 performance is provided with Interface Groups 2, 6 and 9.

When Voice DA Service is combined with Feature Group D Switched Access Service, either Transmission Type A1 or B1 performance is provided. When Voice DA Service is combined with Feature Group B or Feature Group C Switched Access Service, Transmission Type B1 performance is provided.

G. Acceptance Testing and Testing Capabilities

The acceptance testing and testing capabilities for Voice DA Service traffic routed through an access tandem are the same as those for the associated Feature Group C or D end office switching. The acceptance testing for Voice DA Service traffic routed directly to or routed in a separate trunk group through an access tandem to the Voice DA location will be as set forth in 6.1.6, preceding. The testing capabilities for Voice DA Service traffic routed directly to or routed in a separate trunk group through an access tandem to the Voice DA location will be as set forth for cooperative scheduled testing or manual scheduled testing in Section 13, following.

- (M) Material moved to Page 4.
- (M1) Material moved from Page 6.
- (M2) Material moved from Page 7.
- (M3) Material moved from Page 8.

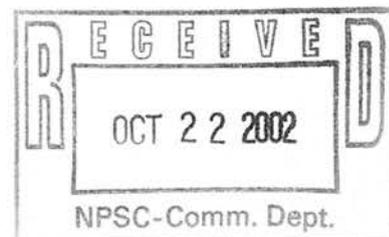

(D)
(M)
(M1)

(T-M1)

(M2)

(M2)

(M3)

(M3)

9. DIRECTORY ASSISTANCE SERVICE

9.2 UNDERTAKING OF THE COMPANY (Cont'd)

H. Supervisory Signaling

Trunkside switching is provided at the Voice DA Service access location. The Voice DA Service access location will provide trunk answer and disconnect supervisory signaling.

(D)
(M)
(M1)

(M1)

9.3 OBLIGATIONS OF THE CUSTOMER

(M2)

- A. The customer shall determine and order the capacity and interface type of Directory Access Services it needs for Voice DA Service. (C)
- B. The customer facilities at the premises of the ordering customer shall provide the necessary on-hook and off-hook supervision. (T)
- C. When requested by the Company, the customer shall order a separate trunk group for Voice DA Service for each NPA. The conditions when the customer will be requested to order a separate trunk group for each NPA are set forth in 9.2, preceding. (T)
(T)
- D. The customer shall be responsible for all contacts and arrangements with its end users concerning the provision and maintenance of, and the billing and collecting of charges for, Voice DA Services furnished to its end users. (T)
- E. The customer understands that Voice DA Operators will respond to at most 2 requests for telephone numbers per call and will not transfer, forward or redial the call to another location for any purpose other than the provision of Voice DA Service. (T)
(T)
(M2)
- F. The customer must provide the Company an estimate of the amount of traffic it will generate on a per month basis for a 12 month period. (N)
(N)

- (M) Material moved to Page 5.
- (M1) Material moved from Page 8.
- (M2) Material moved from Page 13.

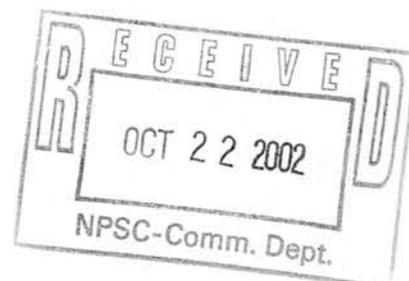

9. DIRECTORY ASSISTANCE SERVICE

9.4 RATE TERMS AND CONDITIONS

(M)
(T-M1)

A. Minimum Periods

There is no minimum period requirement for Voice DA Service.

(C)

B. Minimum Monthly Charge

Voice DA Service is subject to a minimum monthly charge. The minimum monthly charge consists of the following elements.

(C)

For those rate elements that are billed a flat monthly rate; i.e., Directory Transport options, the minimum monthly charge is the monthly rate as set forth in 9.6, following.

(T)

The minimum monthly charge for Directory Transport is the charge as set forth in 9.5, following, for the actual usage for the month.

(T-M1)

C. Cancellation of a Voice DA Order

(T-M2)

A customer may cancel an order for Voice DA Service on any date prior to the service date. The cancellation date is the date the Company receives written or verbal notice from the customer that the order is to be canceled. The verbal notice must be followed by written confirmation within 10 days.

(T)

(T)

(T)

When a customer cancels an order for Voice DA Service after the order date but prior to the start of service, the appropriate charges as set forth in Section 5, preceding, apply for the Directory Access Service canceled. In addition, a charge equal to any unrecoverable capital costs incurred by the Company will apply to the customer.

(T)

D. Changes To Orders

When a customer requests changes to a pending order for Voice DA Service, such changes will be undertaken if they can be accommodated by the Company. The appropriate charges as set forth in Section 5, preceding, apply for the Directory Access Service changed. In addition, a charge equal to any other costs incurred by the Company because of the change will apply.

(T)

(M2)

- (M) Material moved to Page 5.
- (M1) Material moved from Page 16.
- (M2) Material moved from Page 17.

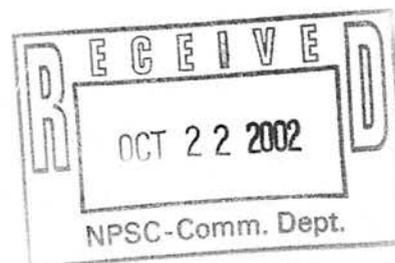

9. DIRECTORY ASSISTANCE SERVICE

9.4 RATE TERMS AND CONDITIONS (Cont'd)

(M)
(D)
(T-M1)

E. Moves

A move involves a change in the physical location of the POT at the customer's premises or of the customer's premises. Moves for Voice DA Service will be treated as set forth in 6.7.6, preceding, and all associated nonrecurring charges will apply.

(C)
(C)

F. Service Rearrangements

For Voice DA Service, nonrecurring charges apply for service rearrangements. Service rearrangements are as set forth in 6.7.1, preceding, for the type of change provided by the Company.

(M1)

G. Credit Allowance for Voice DA Service

(M2)

1. When a Voice DA operator or Voice DA equipment provides an incorrect number for a call and the customer reports such occurrences to the Company, a credit allowance for such Voice DA call will apply. The credit will be as set forth following. When the customer reports such a call and the number requested, the number provided, and the reason the number provided is incorrect, the number of calls for which a credit will apply will be developed by the Company in cooperation with the customer. (T)
2. In the event that the telephone number is unavailable to the Voice DA operator, no credit applies for the charge for the call to the Voice DA operator. (T)
3. When a Voice DA call is not completed due to the failure of Directory Access Service to Voice DA locations, Voice DA access equipment or Voice DA operator activities, a credit allowance for the Switched Access Service portion in the originating LATA of such Voice DA call will apply. When the customer reports such a call and Voice DA number dialed, time of the call and the date of the call, the number of calls for which a credit will apply will be developed by the Company in cooperation with the customer. The credit will be as set forth following. (T)

	CREDIT PER CALL	
• Per call	\$0.023039	(M2)

- (M) Material moved to Pages 5 and 6.
- (M1) Material moved from Page 17.
- (M2) Material moved from Page 18.

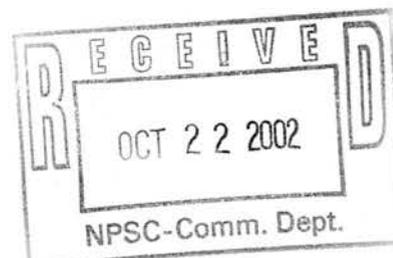

NOTICE

Qwest Corporation
Access Service
Catalog

SECTION 9
Page 9
Release 2
Effective:11-01-2002

State of Nebraska
Notified: 10-22-2002

9. DIRECTORY ASSISTANCE SERVICE

9.4 RATE TERMS AND CONDITIONS (Cont'd)

- H. The Voice DA Service call charge as set forth in 9.5, following, applies for each call to the Voice DA Service and is in addition to the rates described in J. and K., following. (Local Switching rates are not assessed to Voice DA Service.) A call is a call which has been answered by a Voice DA operator. The charge applies whether or not the Voice DA operator provides the requested telephone number. The number of calls answered by Voice DA operators will be accumulated by Company measuring equipment. A credit for the provision of an incorrect telephone number will be applied as set forth in G., preceding.
- I. The mileage for transport is measured from the SWC for the premises of the ordering customer to the Voice DA location. Title Page notwithstanding, these two wire centers may be in different LATAs. In addition, the premises of the ordering customer must be in the LATA where Voice DA service is requested or in the LATA where the Voice DA location is located. The measurement will be performed as set forth in 6.7.11, preceding.
- J. Entrance Facility and Direct-Trunked Transport facility rates are applied as set forth in 6.7.1, preceding.
- K. The TST rates, Tandem Transmission, Tandem Switching, and Common Transport Multiplexing, are assessed for each call to Voice DA Service utilizing tandem routing. The rates are set forth in 9.5, following. The Access Tandem Trunk Port (ATTP) charge is applied as set forth in 6.7.1, preceding. If the customer combines Voice DA trunks with Trunkside Switched Access Service, only one ATTP charge per trunk is assessed.

(D)
(T-M)
(T)
(T)
(C)

(T)
(T)

(T)

(T)
|
(T)

(M)

(M) Material moved from Page 19.

Qwest Corporation
Access Service
Catalog

State of Nebraska
 Notified: 10-22-2002

SECTION 9
 Page 10
 Release 2[2]
 Effective:11-01-2002

9. DIRECTORY ASSISTANCE SERVICE

9.5 RATES AND CHARGES

(D)
 (T-M)

	RATE
A. Voice DA Service Call, per call	\$0.22
B. Switched Transport for Voice DA	
1. Entrance Facilities Monthly recurring rates	[1]
2. Direct-Trunked Transport Monthly recurring rates	[1]
3. Tandem-Switched Transport	
a. Tandem Transmission Rates, per call	
CALL MILES	
FIXED	PER MILE
0	-
0 to 8	\$0.000151
Over 8 to 25	0.000168
Over 25 to 50	0.000172
Over 50	0.000193
	RATE
b. Tandem Switching, per call	\$0.001403
c. Common Transport Multiplexing, per call	0.000330
d. Access Tandem Trunk Port	[1]
4. Installation Charge	[1]

[1] As set forth in 6.8, preceding.

[2] This page cancels Pages 11 through 23, Release 1.

(M) Material moved from Page 21.

(M)

(N)

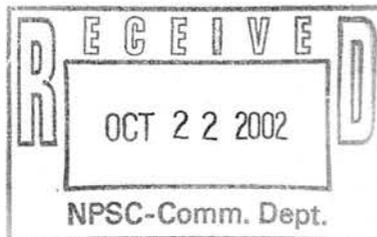

Qwest Corporation
Access Service
Catalog

State of Nebraska
Notified: 9-29-2000

SECTION 10
Index Page 1
Release 1
Effective: 9-29-2000

10. RESERVED FOR FUTURE USE

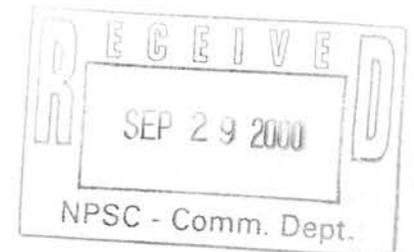

Qwest Corporation
Access Service
Catalog

SECTION 11
Index Page 1
Release 1

State of Nebraska
Notified: 9-29-2000

Effective: 9-29-2000

11. SPECIAL FACILITIES ROUTING OF ACCESS SERVICES

SUBJECT	PAGE
Avoidance	1
Cable-Only Facilities	1
Description	1
Diversity	1
Rates and Charges	2

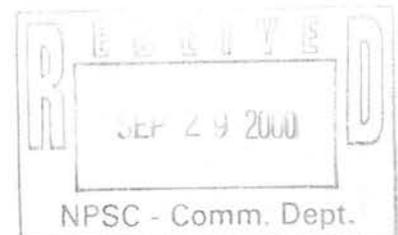

11. SPECIAL FACILITIES ROUTING OF ACCESS SERVICES

11.1 DESCRIPTION

The services provided under this Catalog are provided over such routes and facilities as the Company may elect. Special Facilities Routing is involved when, in order to comply with requirements specified by the customer, the Company provides Switched Access Service, Private Line Transport Service or Federal Government Specialized Service or Arrangements in a manner which includes one or more of the following conditions:

- Diversity

Two or more services must be provided over not more than two different physical routes.

- Avoidance

A service must be provided on a route which avoids specified geographical locations.

- Cable-Only Facilities

Certain Voice Grade services are provided on Cable-Only Facilities to meet the particular needs of a customer.

Service is provided subject to the availability of Cable-Only Facilities. In the event of service failure, restoration will be made through the use of any available facilities as selected by the Company.

Avoidance and Diversity are available on Switched Access Service as set forth in Section 6, preceding. Cable-Only Facilities are available for Switched Access Service as set forth in Section 6, preceding.

In order to avoid the compromise of special routing information, the Company will provide the required routing information for each specially routed service to only the ordering customer. If requested by the customer, this information will be provided when service is installed and prior to any subsequent changes in routing.

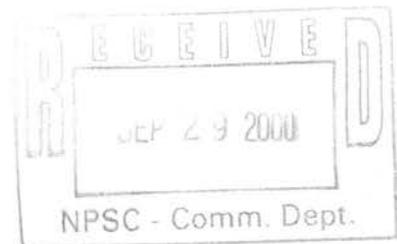

NOTICE

THE INFORMATION CONTAINED IN THIS DOCUMENT IS SUBJECT TO CHANGE.
NE2000-054

11. SPECIAL FACILITIES ROUTING OF ACCESS SERVICES

11.1 DESCRIPTION (Cont'd)

The offering of Special Facilities Routing of Access Services contemplates the use of existing facilities. Should facilities not be available, it may be necessary to construct such facilities, either as (1) normal or (2) special construction. If special construction is involved, the regulations, as set forth in the General Rules and Regulations Applying to Telephone Service will apply.

However, the applicable rates and charges shall be filed in this section of this Catalog. In either case of (1) or (2), preceding, the rates and charges for administration and any other specific items of cost directly attributable to the provision of this service shall be filed in this section also.

11.2 RATES AND CHARGES

The rates and charges for Special Facilities Routing of Access are in addition to all other rates and charges that may be applicable for services provided under other sections of this Catalog.

The rates and charges for Special Facilities Routing of Access Services are as follows:

A. Diversity

For each service provided in accordance with 11.1, preceding, the rates and charges will be developed on an individual case basis:

(T)
(D)
(D)

B. Avoidance

For each service provided in accordance with 11.1, preceding, the rates and charges will be developed on an individual case basis:

(T)
(D)
(D)



Qwest Corporation d/b/a CenturyLink QC
Access Service
Catalog

SECTION 11
Page 3
Release 2
Effective: 03-31-2017

(C)

State of Nebraska
Notified: 03-20-2017

11. SPECIAL FACILITIES ROUTING OF ACCESS SERVICES

11.2 RATES AND CHARGES (Cont'd)

C. Diversity and Avoidance Combined

For each service provided in accordance with 11.1, preceding, combined, the rates and charges will be developed on an individual case basis:

(T)

(D)

(D)

D. Cable-Only Facilities

For each service provided in accordance with 11.1, preceding, the rates and charges will be developed on an individual case basis:

(T)

(D)

(D)

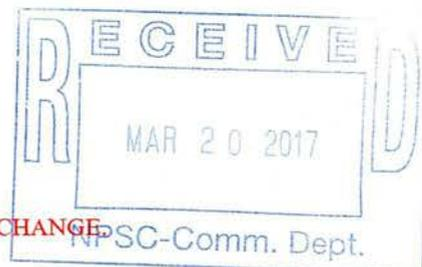

Qwest Corporation
Access Service
Catalog

SECTION 12
Index Page 1
Release 1
Effective: 9-29-2000

State of Nebraska
Notified: 9-29-2000

12. SPECIALIZED SERVICE OR ARRANGEMENT

SUBJECT	PAGE
General.....	1
Move Charges.....	1
Rates and Charges.....	2

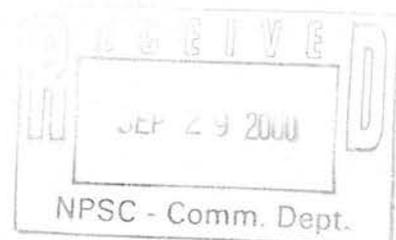

Qwest Corporation
Access Service
Catalog

SECTION 12

Page 1

Release 1

State of Nebraska
Notified: 9-29-2000

Effective: 9-29-2000

12. SPECIALIZED SERVICE OR ARRANGEMENT

12.1 GENERAL

Specialized Service or Arrangements may be provided by the Company, at the request of a customer, on an individual case basis if such service or arrangements meet the following criteria:

- The requested service or arrangements are not offered under other sections of this Catalog.
- The facilities utilized to provide the requested service or arrangements are of a type normally used by the Company in furnishing its other services.
- The requested service or arrangements are provided within a LATA.
- The requested service or arrangements are compatible with other Company services, facilities, and its engineering and maintenance practices.
- This offering is subject to the availability of the necessary Company personnel and capital resources.

12.2 MOVE CHARGES

- A. When service without a maximum termination liability charge associated with it is moved, the charges for moving such service will be based on estimated costs attributable to the move.

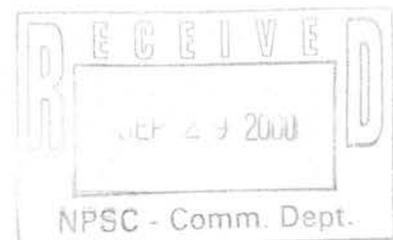

NOTICE

THE INFORMATION CONTAINED IN THIS DOCUMENT IS SUBJECT TO CHANGE.
NE2000-054

12. SPECIALIZED SERVICE OR ARRANGEMENT

12.2 MOVE CHARGES (Cont'd)

B. When service with a maximum termination liability charge associated with it is moved and is reinstalled at a new location, the customer may elect:

- To pay the unexpired portion of the maximum termination liability charge for the service, if any, with the application of a nonrecurring charge and the establishment of a new maximum termination liability charge for such service at the new location, or
- To continue service subject to the unexpired portion of the maximum termination liability charge, if any, and pay the estimated costs of moving such service, provided that the customer requests these charges be quoted prior to ordering the service move. Charges for moving such service will be based on estimated costs attributable to the move.

Move charges include the estimated costs or removal, restoration of services or facilities necessitated by the move, transportation, storage, reinstallation, engineering, labor, supervision, materials, administration, and any other specific items of cost directly attributable to the move.

12.3 RATES AND CHARGES

Rates and charges and additional terms and conditions, if applicable, for specialized service or arrangements are provided for an individual case basis (ICB).

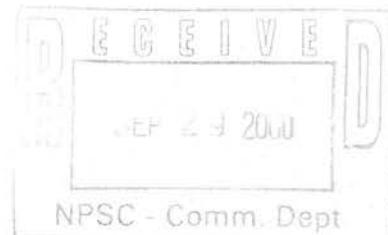

NOTICE

THE INFORMATION CONTAINED IN THIS DOCUMENT IS SUBJECT TO CHANGE.

Qwest Corporation
Access Service
Catalog

SECTION 13
Index Page 1
Release 3

State of Nebraska
Notified: 10-02-2002

Effective: 10-14-2002

13. ADDITIONAL ENGINEERING, ADDITIONAL LABOR
AND MISCELLANEOUS SERVICES

SUBJECT	PAGE	
Additional Engineering.....	1	
Additional Labor.....	1	
Charges for Additional Engineering.....	17	
Charges for Additional Labor.....	18	
Charges for Miscellaneous Service.....	20	
Interexchange Carrier Subscription.....	4	
Maintenance of Service.....	2	
Managed Long Distance (MLD).....	16.1	(N)
Miscellaneous Services.....	2	
Other Labor.....	1	
Overtime Installation.....	1	
Provision of Access Service Billing Information.....	15	
Rates and Charges.....	17	
Special High Voltage Protective Apparatus.....	15	
Standard Jacks - Registration Program.....	10	
Telecommunications Service Priority (TSP).....	3	
Testing Services.....	11	

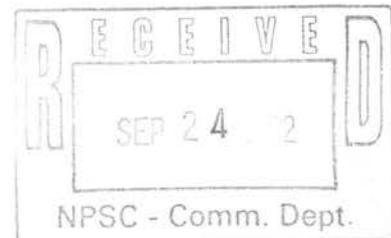

**13. ADDITIONAL ENGINEERING, ADDITIONAL LABOR
AND MISCELLANEOUS SERVICES**

In this section, normal business hours are from Monday through Friday, 8:00 a.m. to 5:00 p.m. Hours before 8:00 a.m. and after 5:00 p.m., Monday through Friday, and all day Saturday, are considered overtime. Sunday and Holidays are premium time.

13.1 ADDITIONAL ENGINEERING

Additional Engineering will be provided by the Company at the request of the customer only when:

- A. A customer requests additional technical information after the Company has already provided the technical information normally included on the Design Layout Report (DLR) as set forth in 6.1.4.
- B. Additional engineering time is incurred by the Company to engineer a customer's request for a customized service.

The Company will notify the customer that additional engineering charges, as set forth in 13.4, following, will apply before any additional engineering is undertaken.

13.2 ADDITIONAL LABOR

Additional labor is that labor requested by the customer on a given service and agreed to by the Company as set forth in 13.2.1 through 13.2.2, following. The Company will notify the customer that additional labor charges as set forth in 13.4, following, will apply before any additional labor is undertaken. The labor charges apply per Company technician performing billable work at the customer's request. When more than one technician is involved in working on a customer's request, the amount of time accrued by all technicians will be totaled to determine the number of 1/2 hour increments to be billed.

13.2.1 OVERTIME INSTALLATION

Overtime installation is that Company installation effort requested by the customer outside of normal business hours.

13.2.2 OTHER LABOR

Other labor is that additional labor not included in 13.2.1, preceding, and labor incurred to accommodate a specific customer request that involves only labor which is not covered by any other section of this Catalog. Other Labor also includes fine tuning circuits (per occurrence) to return them to the originally designated level even though the circuit has not degraded below the designated immediate action level. In addition, Other Labor includes Testing Services as described in 13.3.5. Rates and Charges for Other Labor are set forth in 13.4.2.B.

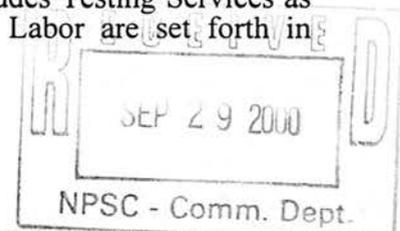

NOTICE

**13. ADDITIONAL ENGINEERING, ADDITIONAL LABOR
AND MISCELLANEOUS SERVICES**

13.3 MISCELLANEOUS SERVICES

13.3.1 MAINTENANCE OF SERVICE

When a customer reports a trouble to the Company for clearance and no trouble is found in the Company's facilities, the customer shall be responsible for payment of a Maintenance of Service charge. In addition, when a customer reports trouble within a quantity of services and circuits, but fails to identify the specific service and circuit which is experiencing trouble, a Maintenance of Service charge applies for the time spent by Company personnel to isolate the trouble. Maintenance of Service charges may apply for trouble isolation without a premises visit and/or trouble isolation with a premises visit. Failure of Company personnel to find trouble in Company facilities will result in no charge if the trouble is actually in those facilities, but not discovered at the time. Maintenance of Service charges are applicable per technician as set forth in 13.4, following. A call-out of a Company employee at a time not consecutive with the employee's scheduled work period is subject to a minimum charge of four hours. No credit allowance will be applicable for the interruption involved if the Maintenance of Service charge applies.

A. Trouble Isolation Without Premises Visit

Maintenance of Service charges apply, per technician, for the period of time from when the customer reports the service(s) for trouble isolation, to when Company personnel have determined that no trouble has been found in Company facilities. This includes the time spent testing operational service(s) in order to isolate those that are out of service or experiencing trouble. No charge applies for the affected services when the trouble is found in the Company's facilities or equipment.

B. Trouble Isolation With Premises Visit

Maintenance of Service charges apply, per technician, for the period of time from when Company personnel are dispatched to an unmanned Company building or to the customer's premises, to when the work is completed. The customer shall be responsible for payment of a Maintenance of Service charge when the trouble is in equipment or communications systems provided by other than the Company or in detariffed CPE provided by the Company. No charge will apply when the trouble is found in the Company's facilities or equipment.

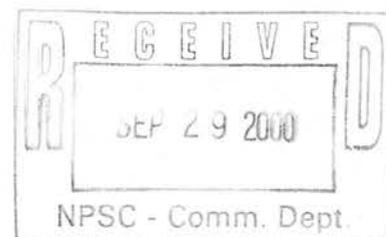

NOTICE

THE INFORMATION CONTAINED IN THIS DOCUMENT IS SUBJECT TO CHANGE.
NE2000-054

Qwest Corporation
Access Service
Catalog

SECTION 13

Page 3

Release 1

Effective: 9-29-2000

State of Nebraska
Notified: 9-29-2000

**13. ADDITIONAL ENGINEERING, ADDITIONAL LABOR
AND MISCELLANEOUS SERVICES**

13.3 MISCELLANEOUS SERVICES

13.3.1 MAINTENANCE OF SERVICE (Cont'd)

C. Trouble Isolation With and Without Premises Visit

Maintenance of Service charges apply, for the time spent performing both Trouble Isolation With and Without A Premises Visit if both are performed, when no trouble is found in Company facilities or equipment.

D. Maintenance of Service charges are billed to the customer of record, where the problem exists, except in cases where a maintenance contract has been purchased.

13.3.2 TELECOMMUNICATIONS SERVICE PRIORITY (TSP)

Denotes the regulatory, administrative, and operational system developed by the Federal Government to ensure priority provisioning and/or restoration of National Security Emergency Preparedness (NSEP) telecommunications services. The Federal Communications Commission (FCC) defines NSEP telecommunications services as those services which are used to maintain a state of readiness or to respond to and manage any event or crisis, which causes or could cause harm to the population, damage to or loss of property, or degrades or threatens the NSEP posture of the United States. See Section 4 of the Private Line Transport Services Catalog for terms, conditions, rates and charges.

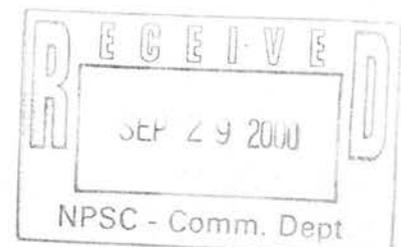

13. ADDITIONAL ENGINEERING, ADDITIONAL LABOR
AND MISCELLANEOUS SERVICES

13.3 MISCELLANEOUS SERVICES (Cont'd)

13.3.3 INTEREXCHANGE CARRIER SUBSCRIPTION

A. Description

Interexchange Carrier (IC) Subscription is a procedure whereby an end user or payphone service provider (PSP) may select and designate to the Company an IC to access without dialing an access code. This procedure applies for both interLATA and intraLATA calls. This IC is referred to as the end user's or PSP's primary IC (PIC). An end user or PSP may select one primary IC for both interLATA and intraLATA service, or they may choose to have two primary ICs, one for interLATA service and a different IC for intraLATA service.

The IC Subscription procedure applies to Telephone Exchange Service lines and/or trunks, Switched Access Lineside connections, Centrex-type lines and Public Access Line (PAL) Service.

- For IC Subscription pay telephones, the PSP will select and designate to the Company an IC to access, without dialing an access code, for intraLATA calls.

Should a caller wish to use the services of an IC other than the primary IC, it is necessary for the caller to dial the IC's access code(s) to reach that IC's service(s).

The terms, conditions, rates and charges for interLATA IC Subscription are found in F.C.C. No. 11, Section 13.

(T)

The terms and conditions for intraLATA IC Subscription are following.

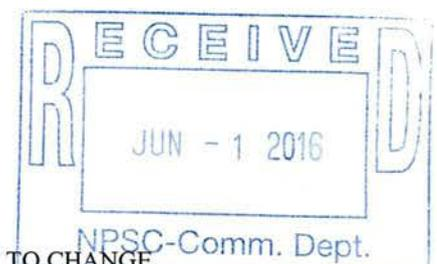

Qwest Corporation
Access Service
Catalog

SECTION 13

Page 5

Release 4

Effective: 7-1-2016

State of Nebraska
Notified: 6-1-2016

13. ADDITIONAL ENGINEERING, ADDITIONAL LABOR
AND MISCELLANEOUS SERVICES

13.3 MISCELLANEOUS SERVICES

13.3.3 INTEREXCHANGE CARRIER SUBSCRIPTION (Cont'd)

B. Terms and Conditions

1. Charge Application for IC Subscription

- a. End users or PSPs placing orders for new service will be asked to select a primary IC at the time they place an order with the Company for Exchange Service, Switched Access Lineside connection, Centrex-type service or PAL Service. There will be no charge for this selection.
- b. End users or PSPs that choose to change their primary IC within 90 days of the effective date of their new service will not be charged for the first such change.
- c. Subsequent to the 90 day waiver period following installation of Telephone Exchange Service, Switched Access Lineside connection, Centrex-type service or PAL Service, for any change in selection, including a change from one access code to another access code for the same IC, a nonrecurring charge applies.
- d. When end users or PSPs simultaneously choose or change an intraLATA and interLATA primary IC, a PIC change charge from F.C.C. No. 11, Section 13, will apply in addition to the applicable charge as set forth in D., following. (T)
- e. The nonrecurring charge for a primary IC change is billed to the end user who is the subscriber to the Telephone Exchange Service, Switched Access Lineside connection, Centrex-type service or to the PSP of PAL Service. However, an IC may, at its option, pay the charge for any end user and/or PSP at any time, or as prescribed by the Company, when the IC has specified that the PIC change request is being made as the result of an end user/PSP disputed PIC change reported to the alleged authorized carrier. The nonrecurring charge for a PIC change is set forth in D., following.

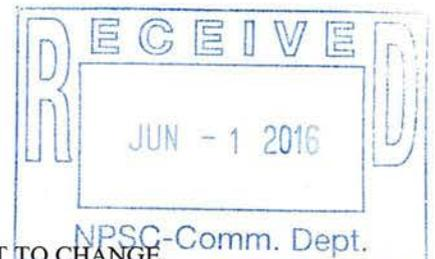

13. ADDITIONAL ENGINEERING, ADDITIONAL LABOR
AND MISCELLANEOUS SERVICES

13.3 MISCELLANEOUS SERVICES

13.3.3 INTEREXCHANGE CARRIER SUBSCRIPTION

B. Terms and Conditions

1. Charge Application for IC Subscription(Cont'd)

f. The applicable primary IC change charge as set forth in D., following, will be determined based on whether the change is requested through manual or electronic means.

(1) A manual change is defined as a change submitted to a customer service representative from an end user request or by a wholesale provider request.

(2) An electronic change is defined as a change submitted by an IC to the Company through the Regional Subscription System (RSS) or processed from an electronic source such as a Company-sponsored website, regardless of whether some manual processing is required.

2. Dispute Application for IC Subscription

If there is a conflict between an end user, a PSP or their respective agent, on one hand, and the IC on the other hand, over the designation of the primary IC, the Company will honor the designation selected by the end user, a PSP or their respective agent, regardless of any contractual obligations the end user, PSP or agent may have with one or more ICs.

If there is a conflict between an end user and/or a PSP, on one hand, and their agent on the other hand, over the designation of the primary IC, the Company will honor the designation selected by the end user and/or PSP regardless of any contractual obligations the end user and/or PSP may have with one or more ICs or agents.

(N)
—
(N)

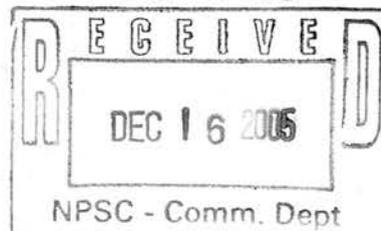

NOTICE

**13. ADDITIONAL ENGINEERING, ADDITIONAL LABOR
AND MISCELLANEOUS SERVICES**

13.3 MISCELLANEOUS SERVICES
13.3.3 INTEREXCHANGE CARRIER SUBSCRIPTION
B. Terms and Conditions (Cont'd)

3. Subscriber Alleged PIC Disputes

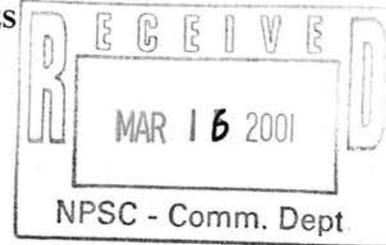

When a subscriber alleges that a PIC change was made without their authorization, the Company shall return the subscriber to their previous PIC at no charge to the subscriber. All PIC change charges assessed by the Company to the subscriber as the result of the alleged unauthorized PIC change shall be credited to the subscriber's service.

Even if no order is received from the alleged unauthorized carrier to switch the customer back to their alleged authorized carrier, the Company will assess two nonrecurring PIC change charges to the alleged unauthorized carrier, one for the initial switch of the subscriber to the alleged unauthorized carrier; the second for the switch from the alleged unauthorized carrier to the alleged authorized carrier as set forth in D., following.

If the alleged unauthorized carrier change was due to a Company error, the subscriber will be returned to the alleged authorized carrier free of charge to both the subscriber and the alleged unauthorized carrier.

(T)

(T)

(T)

13. ADDITIONAL ENGINEERING, ~~ADDITIONAL LABOR~~
AND MISCELLANEOUS SERVICES

- 13.3 MISCELLANEOUS SERVICES
13.3.3 INTEREXCHANGE CARRIER SUBSCRIPTION
B. Terms and Conditions (Cont'd)

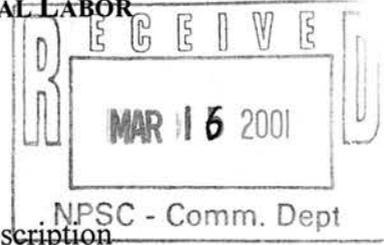

4. Cancellation of Interexchange Participation for IC Subscription

(T)

(T)

If an IC elects to discontinue all of its Feature Group D service in an end office prior to the conversion date or after the introduction of Feature Group D in the converting end office, the IC is obligated to do the following:

- Notify the Company of the cancellation of their Feature Group D service, and;
- Contact all end users or PSPs that are presubscribed to the canceling IC as their primary IC. Inform these end users or PSPs of the cancellation and request that the end users or PSPs contact the Company to select a new primary IC.

The Company will bill the canceling IC the service order charge described in C., following, for each end user or PSP that this IC has currently predesignated to them.

Such charge will not apply to the canceling IC where the canceling IC transfers or assigns its Feature Group D services and the associated 101XXXX code to another IC in such a manner that the Company does not change the end users' or PSPs' records or the end users' or PSPs' PIC designation, or if another IC elects to pay the service order charge on behalf of the canceling IC.

- C. IC Initiated Conversions for IC Subscription

(T)

When an IC requests that their end user or PSP be changed from one access code to another access code on a mass conversion basis, (e.g., an IC using two or more PIC designations or an IC assuming ownership of another IC's end users, etc.) charges will be as set forth in D., following.

Qwest Corporation d/b/a CenturyLink QC
Access Service
Catalog

SECTION 13
 Page 9
 Release 6
 Effective: 03-31-2017

(C)

State of Nebraska
 Notified: 03-20-2017

13. ADDITIONAL ENGINEERING, ADDITIONAL LABOR
AND MISCELLANEOUS SERVICES

13.3 MISCELLANEOUS SERVICES

13.3.3 INTEREXCHANGE CARRIER SUBSCRIPTION (Cont'd)

D. Rates and Charges

	NONRECURRING CHARGE	(T)
1. The charges for a Manual PIC change are as follows:		
• Per Telephone Exchange Service line or trunk	\$5.50	(T)
• Per Switched Access Lineside connection	5.50	
• Per Centrex-type line	5.50	
• Per PAL	5.50	(T)
2. The charges for an Electronic PIC change are as follows:		
• Per Telephone Exchange Service line or trunk	1.25	(T)
• Per Switched Access Lineside connection	1.25	
• Per Centrex-type line	1.25	
• Per PAL	1.25	(T)
3. The charges for a simultaneous Manual PIC change are as follows[1]:		
• Per Telephone Exchange Service line or trunk	5.50	(T)
• Per Switched Access Lineside connection	5.50	
• Per Centrex-type line	5.50	
• Per PAL	5.50	(T)
4. The charges for a simultaneous Electronic PIC change are as follows[1]:		
• Per Telephone Exchange Service line or trunk	1.25	(T)
• Per Switched Access Lineside connection	1.25	
• Per Centrex-type line	1.25	
• Per PAL	1.25	(T)
5. The charges for an IC Initiated Conversion are as follows:		
• Per Telephone Exchange Service line or trunk	0.75	
• Per Switched Access Lineside connection	0.75	
• Per Centrex-type line	0.75	
• Per PAL	0.75	

[1] Simultaneous Manual and Electronic PIC Charges will apply in addition to the charges described in 13.3.3.B.1.d., preceding.

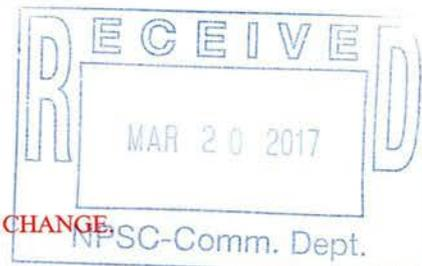

**13. ADDITIONAL ENGINEERING, ADDITIONAL LABOR
AND MISCELLANEOUS SERVICES**

13.3 MISCELLANEOUS SERVICES (Cont'd)

13.3.4 STANDARD JACKS - REGISTRATION PROGRAM

Standard jacks are provided by the Company to connect Registered Equipment to those services that are subject to the Registration Program as set forth in Technical Reference Publication AS No. 1. The use of jacks is covered in Part 68 of the F.C.C.'s Rules and Regulations. Specific jacks are described in the document on file with the F.C.C. entitled "Descriptions of Standard Registration Program Connection Configurations Supplementing Configurations Described in Subpart F of Part 68 of the F.C.C.'s Rules and Regulations."

These jacks are used to terminate services provided by the Company. Other services or facilities provided by the Company or by others may also be terminated in any spare capacity of the jacks remaining after installation without additional charge for the use of such capacity.

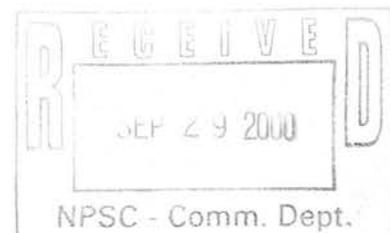

Qwest Corporation
Access Service
Catalog

SECTION 13

Page 11

Release 1

State of Nebraska
Notified: 9-29-2000

Effective: 9-29-2000

**13. ADDITIONAL ENGINEERING, ADDITIONAL LABOR
AND MISCELLANEOUS SERVICES**

13.3 MISCELLANEOUS SERVICES (Cont'd)

13.3.5 TESTING SERVICES

Testing Services offered under this section of the Catalog are optional and subject to rates and charges as set forth in 13.4.3.B., following, except for Additional Cooperative Acceptance Testing and Nonscheduled Testing which are subject to the charges as set forth for Additional Labor - Other in 13.4.2.B., following. Other testing services provided by the Company in association with Access Services are furnished at no additional charge. These other testing services are described in 6.1.5, preceding.

Testing services are normally provided by Company personnel at Company locations. However, provisions are made in A.5., following, for a customer to request Company personnel to perform testing services at the customer's premises.

The offering of Testing Services under this section of the Catalog is made subject to the availability of the necessary qualified personnel and test equipment at the various test locations mentioned in A., following:

A. Switched Access Service

Testing Services for Switched Access are comprised of (a) tests which are performed during the installation of a Switched Access Service, and (b) tests which are performed after acceptance of such access services by a customer, i.e., in-service tests. These in-service tests may be further divided into two broad categories of tests: scheduled and nonscheduled.

Scheduled tests are those tests performed by the Company on a regular basis, e.g., monthly, which result in the measurement of Switched Access Service. Scheduled tests may be done on an automatic basis (no Company or customer technicians involved), on a cooperative basis (Company technician(s) involved at Company office(s) and customer technician(s) involved at customer's premises), or a manual basis (Company technician(s) involved at Company office(s) and at customer's premises).

Nonscheduled tests are performed by the Company "on demand", which result in the measurement of Switched Access Services. Nonscheduled tests may involve Company technicians at Company offices and at the customer's premises.

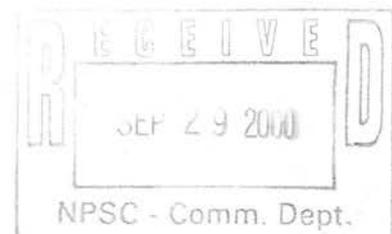

NOTICE

THE INFORMATION CONTAINED IN THIS DOCUMENT IS SUBJECT TO CHANGE.
NE2000-054

**13. ADDITIONAL ENGINEERING, ADDITIONAL LABOR
AND MISCELLANEOUS SERVICES**

13.3 MISCELLANEOUS SERVICES

13.3.5 TESTING SERVICES

A. Switched Access Service (Cont'd)

1. Additional Cooperative Acceptance Testing

Additional Cooperative Acceptance Testing (ACAT) of Switched Access Service involves the Company provision of a technician at its office(s) and the customer provides a technician at its premises, with suitable test equipment to perform the required tests.

Additional Cooperative Acceptance Tests may, for example, consist of the following tests:

- Impulse Noise
- Phase Jitter
- Signal to C-Notched Noise Ratio
- Intermodulation (Nonlinear) Distortion
- Frequency Shift (Offset)
- Envelope Delay Distortion
- Dial Pulse Percent Break

2. Automated Scheduled Testing

Automated Scheduled Testing (AST) of Switched Access Services (Feature Groups B, C and D), where the customer provides remote office test lines and 105 test lines with associated responders or their functional equivalent, will consist of monthly loss and C-message noise tests and annual balance test. However, the customer may specify a more frequent schedule of tests. In addition to the loss/noise/balance tests, the customer may also order, at additional charges, gain-slope and C-notched noise testing.

The Company will provide a monthly AST report that lists the test results for each trunk tested. Trunk test failures requiring customer participation for trouble resolution will be provided to the customer on an as-occurs basis.

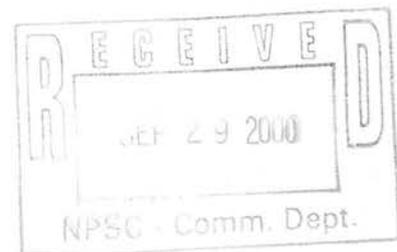

**13. ADDITIONAL ENGINEERING, ADDITIONAL LABOR
AND MISCELLANEOUS SERVICES**

13.3 MISCELLANEOUS SERVICES

13.3.5 TESTING SERVICES

A. Switched Access Service (Cont'd)

3. Cooperative Scheduled Testing

Cooperative Scheduled Testing (CST) of Switched Access Services (Trunkside and Directory Access Service not routed through an access tandem), where the Company provides a technician at its office(s) and the customer provides a technician at its premises, with suitable test equipment to perform the required tests, will consist of quarterly loss and C-message noise tests, and annual balance tests. However, the customer may specify a more frequent schedule of tests. In addition to the loss/noise/balance measurements, the customer may also order, at additional charges, gain-slope and C-notched noise testing.

The Company will provide, on a quarterly basis, an Cooperative Scheduled Testing report that lists the test results for each trunk tested. Trunk test failures requiring customer participation for trouble resolution will be provided to the customer on an as-occurs basis.

4. Manual Scheduled Testing

Manual Scheduled Testing (MST) of Switched Access Services (Trunkside and Directory Access Service not routed through an access tandem), where the Company provides a technician at its office(s) and at the customer's premises, will consist of quarterly loss and C-message noise tests, and annual balance tests. However, the customer may specify a more frequent schedule of tests. In addition to the loss/noise/balance tests, the customer may also order, at additional charges, gain-slope and C-notched noise testing.

The Company will provide, on a quarterly basis, an MST report that lists the test results for each trunk tested. Trunk test failures requiring customer participation for trouble resolution will be provided to the customer on an as-occurs basis.

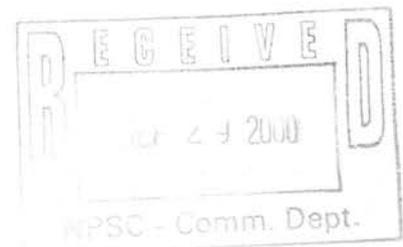

NOTICE

THE INFORMATION CONTAINED IN THIS DOCUMENT IS SUBJECT TO CHANGE.
NE2000-054

**13. ADDITIONAL ENGINEERING, ADDITIONAL LABOR
AND MISCELLANEOUS SERVICES**

13.3 MISCELLANEOUS SERVICES

13.3.5 TESTING SERVICES

A. Switched Access Service (Cont'd)

5. Nonscheduled Testing

Nonscheduled Testing (NST) of Switched Access Service is where:

- The customer provides remote office test lines and 105 test lines with associated responders or their functional equivalent ("automatic testing"), or
- The Company provides a technician at its office(s) and the customer provides a technician at its premises, with suitable test equipment to perform the required tests ("cooperative testing"), or
- The Company provides a technician at its office(s), and/or at the customer's premises with suitable test equipment to perform the required tests ("manual testing").

Nonscheduled Tests may consist of any tests, e.g., loss, noise, slope envelope delay, which the customer may require.

6. Obligations of the Customer

- a. The customer shall provide the Remote Office Test Line priming data to the Company, as appropriate, to support AST as set forth in 2., preceding, or NST as set forth in 5., preceding.
- b. The customer shall make the facilities to be tested available to the Company at times mutually agreed upon.

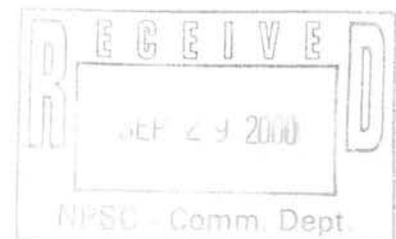

Qwest Corporation
Access Service
Catalog

SECTION 13
Page 15
Release 2
Effective: 7-1-2016

State of Nebraska
Notified: 6-1-2016

**13. ADDITIONAL ENGINEERING, ADDITIONAL LABOR
AND MISCELLANEOUS SERVICES**

13.3 MISCELLANEOUS SERVICES (Cont'd)

13.3.6 PROVISION OF ACCESS SERVICE BILLING INFORMATION

- A. The customer will receive monthly bills and Customer Service Records (CSRs) in a standard paper format at no charge. At the option of the customer, monthly bills and CSRs may be provided electronically, in lieu of the standard paper format at no charge. (C)
- B. At the option of the customer additional copies of the customer monthly bill and/or CSR may be provided in standard paper or electronic format for an additional charge. (C)
- C. Upon acceptance by the Company of an order for electronic transmission, the Company will determine the period of time to implement the transmission of such material on an individual order basis. (T)

13.3.7 SPECIAL HIGH VOLTAGE PROTECTIVE APPARATUS

If Switched Access Service, as set forth in Section 6, preceding, terminates in a high voltage environment, such as an electric power station, Special High Voltage Protective Apparatus may be required as set forth in A. through H., following.

- A. Company facilities which provide service to a customer's electric power generating, switching, or distribution station may require the use of Special High Voltage Protective Apparatus (isolation or neutralization devices, mutual drainage transformers, etc.) on the Company side of the Point of Termination to protect against the effects of Ground Potential Rise (GPR) and induction caused by faults in a customer's electric power system.

The special protection is intended to (1) minimize electrical hazards to personnel, (2) prevent electrical damage to telecommunications equipment and facilities, and (3) provide the required continuity of telecommunications transmission at times of power system faults.

The customer shall be responsible for advising the Company, at the time a service is ordered, of the expected fault-produced electrical environment at the power station so that special protection requirements can be determined.



**13. ADDITIONAL ENGINEERING, ADDITIONAL LABOR
AND MISCELLANEOUS SERVICES**

13.3 MISCELLANEOUS SERVICES

13.3.7 SPECIAL HIGH VOLTAGE PROTECTIVE APPARATUS (Cont'd)

- B. Special High Voltage Protective Apparatus is required on Company facilities at the power station premises under either of the following conditions:
 - 1. When the fault-produced GPR and/or induction at the power station is 1000 volts peak asymmetrical or greater; or
 - 2. When the fault-produced GPR and/or induction at the power station is 300 volts peak or greater, and at least one telecommunication service in the serving Company facility has been identified by a customer as having a requirement for uninterrupted service performance at times of power system faults.
- C. When the conditions in B.2., preceding, are applicable, mutual drainage transformers will be required for noise reduction purposes on the serving facilities at the Company wire center and at any intermediate (remote drainage) locations.
- D. The Company will provide the required Special High Voltage Protective Apparatus in accordance with IEEE Standard 4871980 at rates and charges filed following.
- E. The Company shall be allowed to inspect, at annual intervals, any Special High Voltage Protective Apparatus provided by other than the Company to determine that the special protective installation continues to remain intact and fully effective.
- F. In making this offering, it is understood that the customer that orders Special High Voltage Protective Apparatus may not necessarily be the same customer that orders the Switched and/or Private Line Transport Service with which such apparatus will be associated.

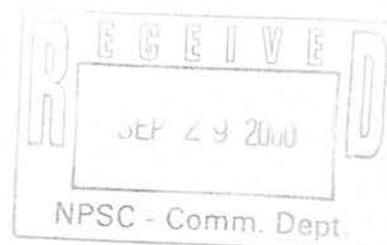

13. ADDITIONAL ENGINEERING, ADDITIONAL LABOR
AND MISCELLANEOUS SERVICES

13.3 MISCELLANEOUS SERVICES (Cont'd)

13.3.8 MANAGED LONG DISTANCE (MLD)

(N)

A. General Description

Managed Long Distance (MLD) is a call management service that provides an IC's end user limited access to 1+ direct dialed long distance calling. Calls are routed through the MLD platform for monitoring, timing and voice prompts and subsequently routed to the IC's tandem switch. MLD enables participating ICs to serve end users without requiring a security deposit.

B. Terms and Conditions

1. The Company undertakes to provide MLD only in those end offices that are suitably equipped.
2. The Primary Interexchange Carrier and Local Interexchange Carrier (PIC/LPIC) must be the same.
3. The IC's end user customers are provided a \$20.00 per month spending limit from the 1st to the 30th of each month.
4. MLD rates are applied on a per minute of use basis. Fractional minutes of use will be rounded up to the next full minute.

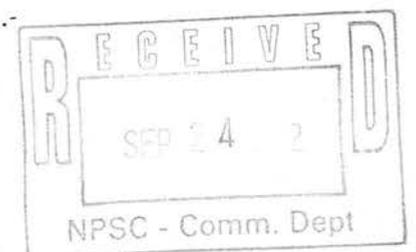

Qwest Corporation d/b/a CenturyLink QC
Access Service
Catalog

SECTION 13
Page 17
Release 2
Effective: 03-31-2017

(C)

State of Nebraska
Notified: 03-20-2017

13. ADDITIONAL ENGINEERING, ADDITIONAL LABOR
AND MISCELLANEOUS SERVICES

13.4 RATES AND CHARGES

13.4.1 CHARGES FOR ADDITIONAL ENGINEERING

ADDITIONAL ENGINEERING PERIODS	NONRECURRING CHARGE	(T)
• Basic Time, per engineer - Each 1/2 hour or fraction thereof	\$30.00	(T)
• Overtime, per engineer - Each 1/2 hour or fraction thereof	40.00	(T)

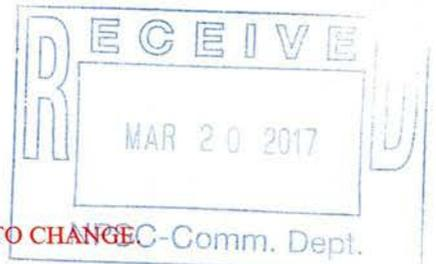

Qwest Corporation d/b/a CenturyLink QC
Access Service
Catalog

SECTION 13
Page 18
Release 2
Effective: 03-31-2017

(C)

State of Nebraska
Notified: 03-20-2017

13. ADDITIONAL ENGINEERING, ADDITIONAL LABOR
AND MISCELLANEOUS SERVICES

13.4 RATES AND CHARGES (Cont'd)

13.4.2 CHARGES FOR ADDITIONAL LABOR

A. Installation

ADDITIONAL LABOR - INSTALLATION PERIODS	NONRECURRING CHARGE	(T)
• Overtime, per technician[1] - Each 1/2 hour or fraction thereof	\$ 9.00	(T)
• Premium Time, per technician[1] - Each 1/2 hour or fraction thereof	17.00	(T)

[1] A call-out of a Company employee at a time not consecutive with the employee's scheduled work period is subject to a minimum charge of four (4) hours.



Qwest Corporation d/b/a CenturyLink QC

**Access Service
Catalog**

SECTION 13
Page 19
Release 2
Effective: 03-31-2017

(C)

State of Nebraska
Notified: 03-20-2017

**13. ADDITIONAL ENGINEERING, ADDITIONAL LABOR
AND MISCELLANEOUS SERVICES**

13.4 RATES AND CHARGES

13.4.2 CHARGES FOR ADDITIONAL LABOR (Cont'd)

B. Other Labor

ADDITIONAL LABOR - OTHER PERIODS	NONRECURRING CHARGE	(T)
• Basic Time, per technician - Each 1/2 hour or fraction thereof	\$28.00	(T)
• Overtime, per technician[1] - Each 1/2 hour or fraction thereof	36.00	(T)
• Premium Time, per technician[1] - Each 1/2 hour or fraction thereof	45.00	(T)

[1] A call-out of a Company employee at a time not consecutive with the employee's scheduled work period is subject to a minimum charge of four (4) hours.

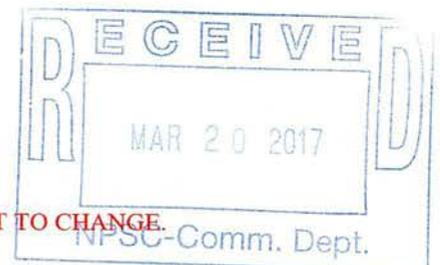

Qwest Corporation d/b/a CenturyLink QC
Access Service
Catalog

SECTION 13
Page 20
Release 2
Effective: 03-31-2017

(C)

State of Nebraska
Notified: 03-20-2017

13. ADDITIONAL ENGINEERING, ADDITIONAL LABOR
AND MISCELLANEOUS SERVICES

13.4 RATES AND CHARGES (Cont'd)

13.4.3 CHARGES FOR MISCELLANEOUS SERVICE

A. Maintenance of Service

MAINTENANCE OF SERVICE PERIODS	NONRECURRING CHARGE	(T)
• Basic Time, per technician - Each 1/2 hour or fraction thereof	\$27.00	(T)
• Overtime, per technician[1] - Each 1/2 hour or fraction thereof	36.00	(T)
• Premium Time, per technician[1] - Each 1/2 hour or fraction thereof	45.00	(T)

[1] A call-out of a Company employee at a time not consecutive with the employee's scheduled work period is subject to a minimum charge of four (4) hours.



**13. ADDITIONAL ENGINEERING, ADDITIONAL LABOR
AND MISCELLANEOUS SERVICES**

13.4 RATES AND CHARGES

13.4.3 CHARGES FOR MISCELLANEOUS SERVICE (Cont'd)

B. Testing Services

1. Additional Cooperative Acceptance Testing (ACAT)

The charges for Additional Cooperative Acceptance Testing are specified in 13.4.2.B., preceding, for Additional Labor - Other Periods.

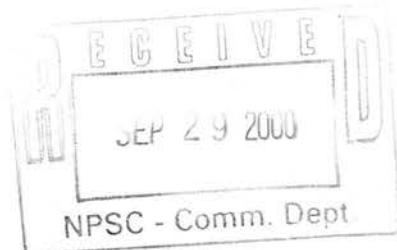

NOTICE

THE INFORMATION CONTAINED IN THIS DOCUMENT IS SUBJECT TO CHANGE.
NE2000-054

13. ADDITIONAL ENGINEERING, ADDITIONAL LABOR
AND MISCELLANEOUS SERVICES

13.4 RATES AND CHARGES

13.4.3 CHARGES FOR MISCELLANEOUS SERVICE

B. Testing Services (Cont'd)

2. Automatic Scheduled Testing (AST)

The three tests as set forth in (a), following, represent the minimum offering, i.e., an order for testing must, at a minimum, consist of twelve (12) 1004 Hz Tests per transmission path, twelve (12) C-Message Noise Tests per transmission path and one Return Loss (Balance) Test per transmission path, per year. The additional Tests as set forth in (b), following, may be ordered by the customer, at additional charges, 60 days prior to the start of the customer prescribed schedule. The customer also may specify a more frequent schedule of tests 60 days prior to the start of the customer prescribed schedule.

a. Basic Tests[1]

TO FIRST POINT OF SWITCHING	MONTHLY RATE	(T)
• 1004 Hz Loss Tests performed within a one-year period, per test ordered, per transmission path	\$0.08	(T)
• C-Message Noise Tests performed within a one-year period, per test ordered, per transmission path	0.08	(T)
• Return Loss (Balance) Tests performed within a one-year period, per test ordered, per transmission path	0.03	(T)

[1] Subject to a one-year minimum contract period, and annually thereafter.



Qwest Corporation d/b/a CenturyLink QC
Access Service
Catalog

SECTION 13
Page 23
Release 2
Effective: 03-31-2017

(C)

State of Nebraska
Notified: 03-20-2017

13. ADDITIONAL ENGINEERING, ADDITIONAL LABOR
AND MISCELLANEOUS SERVICES

13.4 RATES AND CHARGES

13.4.3 CHARGES FOR MISCELLANEOUS SERVICE

B.1. (Cont'd)

b. Additional Tests

TO FIRST POINT OF SWITCHING	MONTHLY RATE	(T)
• Gain-Slope Tests performed within a one-year period, per test ordered, per transmission path	\$0.03	(T)
• C-Notched Noise Tests performed within a one-year period, per test ordered, per transmission path	0.03	(T)

c. Example

A customer schedules thirteen (13) 1004 Hz Loss Tests, thirteen (13) C-Message Noise Tests and two (2) Return Loss Tests on one trunk for a year. The charges will be computed as follows:

$$\begin{array}{r} 13 \times \$0.08 = \$1.04 \\ + 13 \times 0.08 = 1.04 \\ + 2 \times 0.03 = \underline{0.06} \\ \$2.14 \text{ per month, per trunk} \end{array}$$

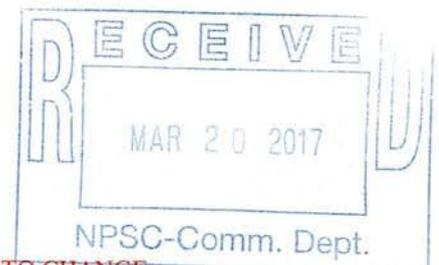

13. ADDITIONAL ENGINEERING, ADDITIONAL LABOR
AND MISCELLANEOUS SERVICES

13.4 RATES AND CHARGES

13.4.3 CHARGES FOR MISCELLANEOUS SERVICE

B. Testing Services (Cont'd)

2. Cooperative Scheduled Testing (CST)

The three (3) tests as set forth in (1), following, represent the minimum offering, i.e., an order for testing must, at a minimum, consist of four (4) 1004 Hz Loss Tests per transmission path, four (4) C-Message Noise Tests per transmission path and one (1) Return Loss (Balance) Test per transmission path, per year. The Additional Tests as set forth in (2), following, may be ordered by the customer, at additional charges, 60 days prior to the start of the customer prescribed schedule. The customer also may specify a more frequent schedule of tests 60 days prior to the start of the customer prescribed schedule.

a. Basic Tests[1]

TO FIRST POINT OF SWITCHING	MONTHLY RATE	(T)
• 1004 Hz Loss Tests performed within a one-year period, per test ordered, per transmission path	\$0.23	(T)
• C-Message Noise Tests performed within a one-year period, per test ordered, per transmission path	0.23	(T)
• Return Loss (Balance) Tests performed within a one-year period, per test ordered, per transmission path	0.12	(T)

[1] Subject to a one-year minimum contract period, and annually thereafter.

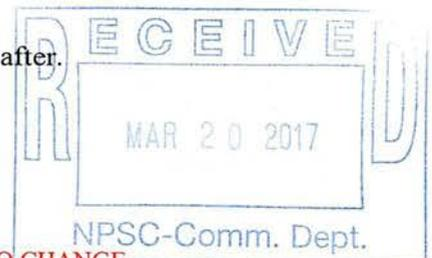

Qwest Corporation d/b/a CenturyLink QC
Access Service
Catalog

SECTION 13
Page 25
Release 2
Effective: 03-31-2017

(C)

State of Nebraska
Notified: 03-20-2017

13. ADDITIONAL ENGINEERING, ADDITIONAL LABOR
AND MISCELLANEOUS SERVICES

13.4 RATES AND CHARGES

13.4.3 CHARGES FOR MISCELLANEOUS SERVICE

B.2. (Cont'd)

b. Additional Tests

	MONTHLY RATE	(T)
TO FIRST POINT OF SWITCHING		
• Gain-Slope Tests performed within a one-year period, per test ordered, per transmission path	\$0.06	(T)
• C-Notched Noise Tests performed within a one-year period, per test ordered, per transmission path	0.06	(T)

c. Example

A customer schedules six (6) 1004 Hz Loss Tests, six (6) C-Message Noise Tests and four (4) Return Loss Tests on one trunk for a year. The charges will be computed as follows:

$$\begin{array}{rcl} 6 & \times & \$0.23 & = & \$1.38 \\ + 6 & \times & 0.23 & = & 1.38 \\ + 4 & \times & 0.12 & = & \underline{0.48} \\ & & & & \$3.24 \text{ per month, per trunk} \end{array}$$



State of Nebraska
Notified: 03-20-2017

13. ADDITIONAL ENGINEERING, ADDITIONAL LABOR
AND MISCELLANEOUS SERVICES

13.4 RATES AND CHARGES
13.4.3 CHARGES FOR MISCELLANEOUS SERVICE
B. Testing Services (Cont'd)

3. Manual Scheduled Testing (MST)

The three (3) tests as set forth in (1), following, represent the minimum offering, i.e., an order for testing must, at a minimum, consist of four (4) 1004 Hz Loss Tests per transmission path, four (4) C-Message Noise Tests per transmission path and one (1) Return Loss (Balance) Test per transmission path, per year. The Additional Tests as set forth in (2), following, may be ordered by the customer, at additional charges, 60 days prior to the start of the customer prescribed schedule. The customer also may specify a more frequent schedule of tests 60 days prior to the start of the customer prescribed schedule.

a. Basic Tests[1]

TO FIRST POINT OF SWITCHING	MONTHLY RATE	(T)
• 1004 Hz Loss Tests performed within a one-year period, per test ordered, per transmission path	\$0.54	(T)
• C-Message Noise Tests performed within a one-year period, per test ordered, per transmission path	0.54	(T)
• Return Loss (Balance) Tests performed within a one-year period, per test ordered, per transmission path	0.30	(T)

[1] Subject to a one-year minimum contract period, and annually thereafter.

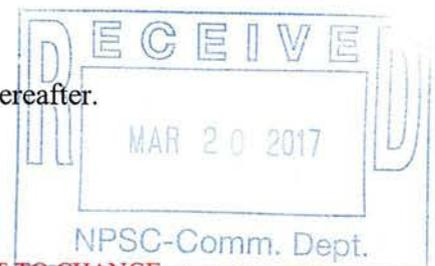

Qwest Corporation d/b/a CenturyLink QC
Access Service
Catalog

SECTION 13
Page 27
Release 2
Effective: 03-31-2017

(C)

State of Nebraska
Notified: 03-20-2017

**13. ADDITIONAL ENGINEERING, ADDITIONAL LABOR
AND MISCELLANEOUS SERVICES**

13.4 RATES AND CHARGES
13.4.3 CHARGES FOR MISCELLANEOUS SERVICE
B.3. (Cont'd)

b. Additional Tests

TO FIRST POINT OF SWITCHING	MONTHLY RATE	(T)
• Gain-Slope Tests performed within a one-year period, per test ordered, per transmission path	\$0.19	(T)
• C-Notched Noise Tests performed within a one-year period, per test ordered, per transmission path	0.19	(T)

c. Example

See 2.C., preceding.

4. Nonscheduled Testing (NST)

a. Automatic Testing

TO FIRST POINT OF SWITCHING	NONRECURRING CHARGE	(T)
• 1004 Hz Loss, per test performed	\$0.44	(T)
• C-Message Noise, per test performed	0.44	(T)
• Return Loss (Balance), per test performed	0.73	(T)
• Gain-Slope, per test performed	0.44	(T)
• C-Notched Noise, per test performed	0.44	(T)

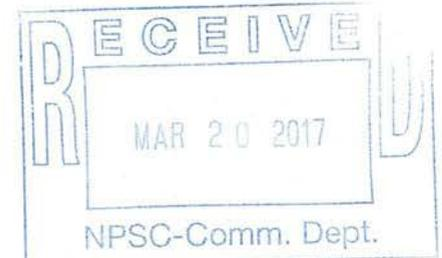

Qwest Corporation
Access Service
Catalog

SECTION 13
Page 28

State of Nebraska
Notified: 9-29-2000

Release 1
Effective: 9-29-2000

**13. ADDITIONAL ENGINEERING, ADDITIONAL LABOR
AND MISCELLANEOUS SERVICES**

13.4 RATES AND CHARGES

13.4.3 CHARGES FOR MISCELLANEOUS SERVICE

B.4. (Cont'd)

b. Cooperative Testing

The charges for Cooperative Testing are specified in 13.4.2.B., preceding, for Additional Labor - Other Periods.

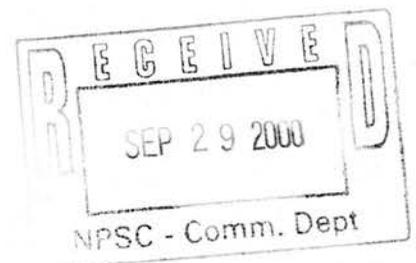

Qwest Corporation
Access Service
Catalog

SECTION 13
Page 29

State of Nebraska
Notified: 9-29-2000

Release 1
Effective: 9-29-2000

**13. ADDITIONAL ENGINEERING, ADDITIONAL LABOR
AND MISCELLANEOUS SERVICES**

13.4 RATES AND CHARGES

13.4.3 CHARGES FOR MISCELLANEOUS SERVICE

B.4. (Cont'd)

c. Manual Testing

The charges for Manual Testing are specified in 13.4.2.B., preceding, for Additional Labor - Other Periods.

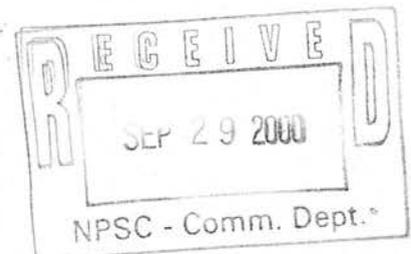

Qwest Corporation d/b/a CenturyLink QC
Access Service
Catalog

SECTION 13
Page 30
Release 2
Effective: 03-31-2017

(C)

State of Nebraska
Notified: 03-20-2017

13. ADDITIONAL ENGINEERING, ADDITIONAL LABOR
AND MISCELLANEOUS SERVICES

13.4 RATES AND CHARGES

13.4.3 CHARGES FOR MISCELLANEOUS SERVICE (Cont'd)

C. Standard Voice Jacks

	NONRECURRING CHARGE	(T)
1. Miniature six-position jacks for connection of terminal equipment as follows:		
• Single-line telephone set surface or flush mounted	\$5.99	(T)
• Single-line telephone sets wall mounted	5.99	(T)
• Two-line non-key telephone sets surface or flush mounted	5.99	(T)
• Single-line bridged 4-wire exchange 2/RT, T1/R1	5.99	(T)
• Two-line non-key telephone sets wall mounted	5.99	(T)
• Special single-line equipment for use in hospital critical care areas	5.99	(T)
• 9DB single-line data equipment with mode indication and mode indication common leads. This jack is normally used in association with a series jack	5.99	(T)
• Three-line non-key telephone sets and ancillary devices	5.99	(T)



Qwest Corporation d/b/a CenturyLink QC

Access Service
Catalog

SECTION 13
Page 31
Release 2
Effective: 03-31-2017

(C)

State of Nebraska
Notified: 03-20-2017

13. ADDITIONAL ENGINEERING, ADDITIONAL LABOR
AND MISCELLANEOUS SERVICES

13.4 RATES AND CHARGES

13.4.3 CHARGES FOR MISCELLANEOUS SERVICE

C. Standard Voice Jacks (Cont'd)

	NONRECURRING CHARGE	(T)
2. 50-Position Miniature Ribbon for connection of multiline terminating equipment and channel derivation devices as follows:		
• For connection to 2-wire tie trunks E&M type I signaling (12-line capacity)	\$57.39	(T)
• For connection to 4-wire tie trunks E&M type I signaling (8-line capacity)	57.39	(T)
• For connection to 2-wire tie trunks E&M type II signaling (8-line capacity)	57.39	(T)
• For connection to 4-wire tie trunks E&M type II signaling (6-line capacity)	57.39	(T)
• For connection to off-premises station lines (25-line capacity)	57.39	(T)
• For use with series devices such as toll restrictors (12-line capacity)	80.47	(T)
• For connection of up to 12 line bridged 4-wire exchange 2/RT, T1/R1	57.39	(T)

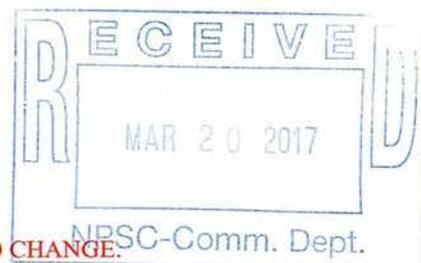

Qwest Corporation d/b/a CenturyLink QC
Access Service
Catalog

SECTION 13
Page 32
Release 2
Effective: 03-31-2017

(C)

State of Nebraska
Notified: 03-20-2017

13. ADDITIONAL ENGINEERING, ADDITIONAL LABOR
AND MISCELLANEOUS SERVICES

13.4 RATES AND CHARGES

13.4.3 CHARGES FOR MISCELLANEOUS SERVICE

C. Standard Voice Jacks (Cont'd)

	NONRECURRING CHARGE	(T)
3. Series Jacks for connection of terminal equipment as follows:		
• Single-line alarm reporting devices	\$21.66	(T)
• Series ancillary devices such as automatic dialers. Single-line sets with exclusion	21.66	(T)
• Two-line telephone sets with exclusion on one line	21.66	(T)
4. Weatherproof jack for use with single-line telephone sets used at locations such as boats and marinas	39.72	(T)

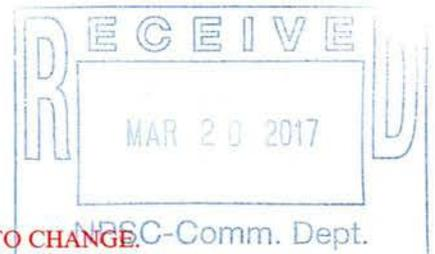

Qwest Corporation d/b/a CenturyLink QC
Access Service
Catalog

SECTION 13
Page 33
Release 2
Effective: 03-31-2017

(C)

State of Nebraska
Notified: 03-20-2017

13. ADDITIONAL ENGINEERING, ADDITIONAL LABOR
AND MISCELLANEOUS SERVICES

13.4 RATES AND CHARGES

13.4.3 CHARGES FOR MISCELLANEOUS SERVICE (Cont'd)

D. Standard Data Jacks

	NONRECURRING CHARGE	(T)
1. Universal Data Jack for use in connecting fixed loss loop (FLL) and programmed (P) types of data equipment (1-line capacity)	\$ 38.84	(T)
2. Programmed Data Jack for use in connecting programmed data equipment (1-line capacity)	33.11	(T)
3. Multiple-Line Universal Data Jack for use in connecting fixed loss loop (FLL) and programmed (P) types of data equipment. This jack will terminate up to eight lines. The selection of this jack requires the use of the equipment listed following.	167.69	(T)
• Multiple-Line Universal Data Jack Circuit Cards. For use with RJ26X. One circuit card per circuit required.	23.65	(T)
• Multiple-Line Universal Data Jack Mounting options. For use with RJ26X. One required per RJ26X		
- Wall Mounting with cover	33.49	(T)
- Rack Mounting (19 inch or 23 inch)	29.17	(T)

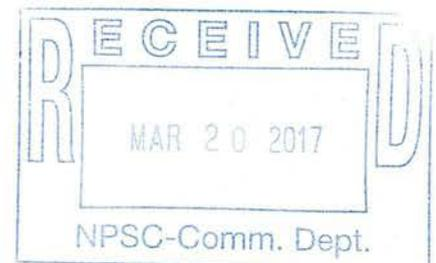

NOTICE

THE INFORMATION CONTAINED IN THIS DOCUMENT IS SUBJECT TO CHANGE.

Qwest Corporation
Access Service
Catalog

SECTION 13

Page 34

Release 3

State of Nebraska
Notified: 6-1-2016

Effective: 7-1-2016

**13. ADDITIONAL ENGINEERING, ADDITIONAL LABOR
AND MISCELLANEOUS SERVICES**

13.4 RATES AND CHARGES

13.4.3 CHARGES FOR MISCELLANEOUS SERVICE (Cont'd)

- E. The rates and charges for the provision of additional copies of Access Service Billing Information after the initial copy has been provided are as follows: (C)
(C)

RATE

1. Electronic Transmission of Billing Detail and/or Information to a Customer's Premises, per record transmitted (T)
ICB

2. Additional Copies of the Customer's Monthly Bill and/or CSR

- Paper
- Per request[1] \$19.53 (R)
- + per page 0.01

(D)

(D)

- F. Managed Long Distance (MLD)

RATE

- Per minute of use \$0.07

[1] Applies for each bill and each CSR requested.

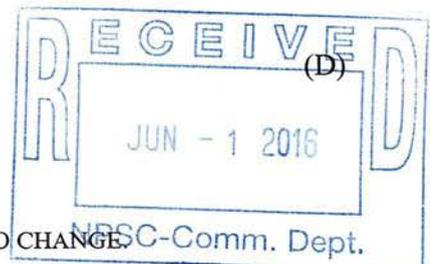

NOTICE

THE INFORMATION CONTAINED IN THIS DOCUMENT IS SUBJECT TO CHANGE
NE2016-001

Qwest Corporation
Access Service
Catalog

State of Nebraska
Notified: 9-29-2000

SECTION 14
Index Page 1
Release 1
Effective: 9-29-2000

14. RESERVED FOR FUTURE USE



Qwest Corporation
Access Service
Catalog

SECTION 15
Index Page 1
Release 2

State of Nebraska
Notified: 05-25-2001

Effective: 06-06-2001

15. COMMON CHANNEL SIGNALING NETWORK (CCSN)

SUBJECT	PAGE	
Call Set-up	9	(N)
CCSAC Acceptance Testing Requirements.....	8	(T)
CCSAC Additional Cooperative Acceptance Testing Requirements.....	9	
CCSAC Network Management.....	6	
CCSAC Ordering Requirements.....	6	
CCSAC Performance Requirements.....	8	
CCSAC Rate Categories	3	
CCSAC Service Applications.....	9	
CCSAC Service Provisioning.....	7	
Common Channel Signaling Access Capability (CCSAC).....	2	(T)
General Description	1	(D)
Ordering, Service Provisioning and Performance Requirements	6	(T)
Rate Categories	4	(D)
Rates and Charges.....	10	(T)
Report Requirements	6	
Service Description.....	2	
Testing Requirements	8	(T)

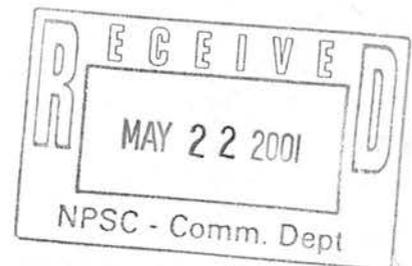

15. COMMON CHANNEL SIGNALING NETWORK (CCSN)

15.1 GENERAL DESCRIPTION

Common Channel Signaling Access Capability (CCSAC) allows a customer to connect with the Company's SS7 network. CCSAC is used in conjunction with other SS7 based features and services. CCSAC provides the means for transmitting SS7 out of band signaling information via Switched Access CCS Links between the customer's Signaling Point of Interface (SPOI) and the Company's Signal Transfer Point (STP). The STP provides translations and routing functions for SS7 signaling messages received from the Company's network signaling points and the SS7 networks of other entities. There are two types of signaling messages. ISDN User Part (ISUP) messages are used for call set-up (establishing and closing transmission paths for voice and data calls over the public switched network). Transaction Capabilities Application Part (TCAP) messages are used to carry information between signaling points for call related database services. CCSAC acts as a platform for the following applications.

The customer's SPOI and the Company's STP wire center must be located within the same LATA.

A. Call Set-Up

This application provides the customer the capability to send originating and terminating call set-up signaling information, via ISUP messages, between the customer's designated premises, the Company's STP and other entities in association with message telecommunications service. Call Set-Up may be associated with calls that utilize the Company's switched access network or may be associated with calls that do not utilize the Company's switched access network. If the message trunks are provided by the Company, the customer must order the associated FGD trunks with SS7 Out of Band Signaling option as set forth in Section 6, preceding. Call Set-Up associated with calls that do not utilize the Company's switched access network is referred to as transient call set-up and the customer must have message trunks with SS7 capabilities. CCSAC Service as set forth in this section is required to provide both capabilities.

B. Foreign Database Queries

This service provides the customer the ability to query foreign databases (databases not maintained by the Company) by sending signaling information via TCAP messages between the Company's STP, the customer's designated premises and the foreign database. CCSAC Service as set forth in this section is required to provide this capability.

(M) Material moved to Page 2.

(T)

(C)

(C)

(N)

(N)

(M)

15. COMMON CHANNEL SIGNALING NETWORK (CCSN)

15.2 SERVICE DESCRIPTION

15.2.1 COMMON CHANNEL SIGNALING ACCESS CAPABILITY (CCSAC)

CCSAC transmission specifications, diversity requirements and testing parameters are set forth in Technical Reference GR-905-CORE, GR-954-CORE and 77342. Diversity will be provided as mutually agreed upon by the Company and the customer based upon availability from the customer's STP, SP or SSP location to the Company's STP. If applicable, Special Construction terms, conditions and charges will apply. CCSAC interconnection is available only in suitably equipped Company STP locations.

CCSAC network interface specifications between the Company's STP location and the customer's STP location supporting Integrated Services Digital Network (ISDN) signaling are described in Technical Reference GR-905-CORE.

A. CCS Link

CCSAC is provided by a CCS Link. The CCS Link provides digital bidirectional transmission and operates at a DS0-A level (i.e., 56 kbps of CCS7 signaling data and 8 kbps of control/supervisory data). Each DS0-A channel (link) occupies a single DS0 (i.e., 64 kbps) channel of a 24 channel DS1 digital transmission system. The DS0-A channel (link) is multiplexed into a DS1 format for hand off at the customer's SPOI. One STP Port is required for each 56 kbps signaling link utilized for CCSAC at the Company STP. The STP Port is the POT to the signal switching capability of the STP and is dedicated to the customer. The CCS Link is transported via an Entrance Facility and a Direct Link Transport (DLT) facility as described in 1. and 2., following, and is utilized exclusively for connecting the customer's CCS network and the Company's CCSN for the transmission of network control signaling data only.

(N)
|
(N)

(M)

(M) Material moved to Page 2.1.



Qwest Corporation
Access Service
Catalog

SECTION 15

Page 2.1

Release 2

Effective: 7-1-2016

State of Nebraska
Notified: 6-1-2016

15. COMMON CHANNEL SIGNALING NETWORK (CCSN)

15.2 SERVICE DESCRIPTION

15.2.1 COMMON CHANNEL SIGNALING ACCESS CAPABILITY (CCSAC)

A. CCS Link(Cont'd)

1. Entrance Facility

The Entrance Facility provides the connection from the customer's SPOI to the serving wire center (SWC) of the customer's SPOI on a dedicated DS1 facility ordered as set forth in this section and is utilized exclusively for the transmission of network control signaling data only. The customer may utilize an existing DS1 Entrance Facility previously ordered from this section for additional CCS Links or order a new DS1 Entrance Facility from this section. The customer may also choose to utilize a portion (i.e., DS1) of an existing DS3 facility under the regulations of Shared Use. The DS3 facility can only be ordered from Section 6, preceding, or Section 7, of the Interstate Access Service Tariff, F.C.C. No. 11. Multiplexing arrangements and the associated regulations are set forth in 6.1.2, preceding. When the customer chooses to use a portion of an existing DS3 facility, the customer must allocate, at a minimum, one dedicated DS1 for the provision of the signaling links. Rate applications for Shared Use are set forth in 2.7, preceding.

(T)

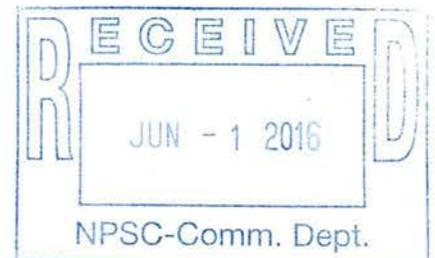

NOTICE

THE INFORMATION CONTAINED IN THIS DOCUMENT IS SUBJECT TO CHANGE.

NE2016-001

15. COMMON CHANNEL SIGNALING NETWORK (CCSN)

15.2 SERVICE DESCRIPTION

15.2.1 COMMON CHANNEL SIGNALING ACCESS CAPABILITY (CCSAC)

A. CCS Link (Cont'd)

2. Direct Link Transport (DLT)

The DLT provides for the transmission facilities between the SWC of the customer's SPOI and the Company's STP. The customer has the option of ordering a DS1 DLT facility from this section, utilized exclusively for the transmission of network control signaling data only, or a single DS0-A channel (i.e., 64 kbps) of a 24 channel DS1 facility. The customer may utilize an existing DS1 DLT facility previously ordered from this section for additional CCS Links or order a new DS1 DLT or a DS0 DLT facility.

Company hubbing arrangements can be utilized for CCSAC. If the customer has an existing DS3 facility between the SWC of the customer's premises and a Company Hub, ordered and provisioned as set forth in Section 6, preceding, or Section 7, of the Interstate Access Service Tariff, F.C.C. No. 11, the customer may utilize a portion (i.e., DS1) of the existing DS3 facility for the CCS Link(s) under the provisions of the Shared Use regulations as set forth in 2.7, preceding. In addition, the customer must order the DS1 or DS0 DLT from the Company Hub to the Company STP.

(T)

When the customer orders a DS1 DLT facility from the SWC of the customer's SPOI or a Company Hub to a Company STP, the customer must order a DS1 to DS0 Multiplexer at the Company STP for termination into the STP Port. When the customer orders a DS0 DLT channel, the customer must also order a DS1 to DS0 Multiplexer at the SWC of the customer's SPOI. Multiplexing rates are set forth in 15.8, following.

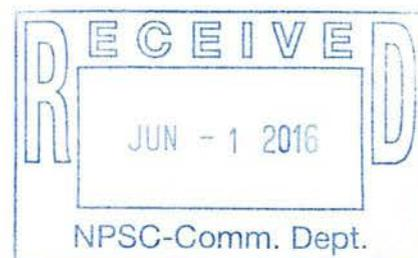

NOTICE

THE INFORMATION CONTAINED IN THIS DOCUMENT IS SUBJECT TO CHANGE.
NE2016-001

15. COMMON CHANNEL SIGNALING NETWORK (CCSN)

15.3 RATE CATEGORIES

15.3.1 CCSAC RATE CATEGORIES

CCS Link rates and charges are set forth in 15.8, following. Carrier Common Line, as set forth in Section 3, preceding, and Switched Access rates, as set forth in Section 6, preceding, are not applicable.

A. Nonrecurring Charges

(N)

Each CCS Link is assessed a nonrecurring charge per link provided on a first and each additional basis, per order.

Any change in CCSAC Service, except a change in jurisdiction, will be treated as a discontinuance of the existing service and an installation of a new service. Minimum period requirements are as set forth in 5.2.5, preceding.

(T)

(T)

B. Monthly Rates

(N)

The Entrance Facility monthly rate is assessed on a per DS1 facility provided when the Entrance Facility is ordered from this section for CCSAC. When the customer has Shared Use facilities, the monthly rates are apportioned as set forth in 2.7, preceding.

For each DLT facility provided, DS0 or DS1, a fixed monthly rate, per mile band, and a monthly rate per mile is assessed. When the customer has Shared Use facilities, the monthly rates are apportioned as set forth in 2.7, preceding. Mileage measurement is calculated on a airline mile basis, using the V & H coordinates method, between the SWC of the customer's SPOI and the Company's STP. When DLT facilities of different capacities are connected by a multiplexer at a Company Hub, mileage is measured separately from the SWC of the customer's premises to the Company Hub, where multiplexing occurs, and then measured from the Company Hub to the Company STP.

An STP Port is provided for each CCS Link and each STP Port is assessed a monthly rate.

(T)

EF and DTT multiplexing equipment is assessed a monthly rate per arrangement provided. When the customer has Shared Use facilities, the monthly rates are apportioned as set forth in 2.7, preceding.

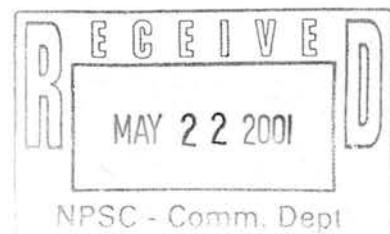

NOTICE

THE INFORMATION CONTAINED IN THIS DOCUMENT IS SUBJECT TO CHANGE.
NE2001-041

15. COMMON CHANNEL SIGNALING NETWORK (CCSN)

15.3 RATE CATEGORIES

15.3.1 CCSAC RATE CATEGORIES (Cont'd)

C. Message Charges

Message charges, as set forth in 15.8, following, are assessed based on the type of message protocol, ISUP or TCAP. ISUP messages are associated with call set-up, while TCAP messages are used to query call related databases. ISUP message charges are assessed per call set-up request and TCAP message charges are assessed per data request.

Message charges do not apply for TCAP messages switched by the regional STPs to the Company provided 800 Data Base, LIDB or LNP Data Base. Query charges are assessed in lieu of message charges. Query charges for 800 Data Base are assessed as set forth in 6.8, preceding. When TCAP messages are destined for a foreign database, including a non-company provided LNP Data Base, message charges are assessed in lieu of query charges.

Message charges are assessed in the following manner.

1. Signal Formulation

An ISUP Signal Formulation charge is assessed, per call set-up request, for formulating signaling messages in association with call set-up.

2. Signal Transport

An ISUP Signal Transport charge is assessed, per call set-up request, for signaling messages transported to or from the Company STP in association with call set-up.

A TCAP Signal Transport charge is assessed per data request transported to or from a Company STP and destined for a foreign database.

3. Signal Switching

An ISUP Signal Switching charge is assessed per call set-up request that is switched at the Company STP.

A TCAP Signal Switching charge is assessed for each data request that is switched by the Company STP and destined for a foreign network or database.

(M) Material moved to Pages 6 and 7.

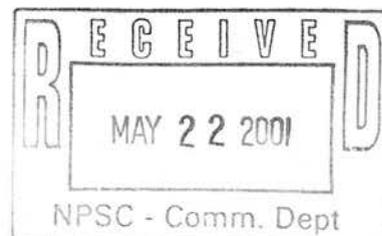

(N)

(N)

(M)

15. COMMON CHANNEL SIGNALING NETWORK (CCSN)

15.4 REPORT REQUIREMENTS

15.4.1 CCSAC NETWORK MANAGEMENT

The customer shall provide semiannually a CCSAC Network Management Report. The CCSAC Network Management Report requirements are described in Technical Reference 77342. The Company will use the report information in its own effort to further project CCSN facility requirements.

15.5 ORDERING, SERVICE PROVISIONING AND PERFORMANCE REQUIREMENTS

15.5.1 CCSAC ORDERING REQUIREMENTS

When a customer orders CCSAC, the customer must specify the customer STP premises, the number of CCS Links and the service (application) requiring CCSAC connectivity. One STP Port is provided for each link ordered. In addition, the customer must specify, at a minimum, information for the Entrance Facility and the DLT as described following.

The customer must have capacity available on an existing DS1 Entrance Facility (ordered and provisioned from this section) or a DS3 facility (ordered and provisioned from Section 6, preceding or Section 7, of the Interstate Access Service Tariff, F.C.C. No. 11.) between the customer's SPOI and the SWC of the customer's SPOI with a compatible interface or request a DS1 Entrance Facility. If the Entrance Facility is existing, the customer shall provide the Circuit Facility Assignment (CFA) of the existing facilities that will be utilized.

(T)

In addition the customer must specify the type of DLT facility, DS1 or DS0, to be utilized or provided between the SWC of the customer's SPOI and the Company's STP.

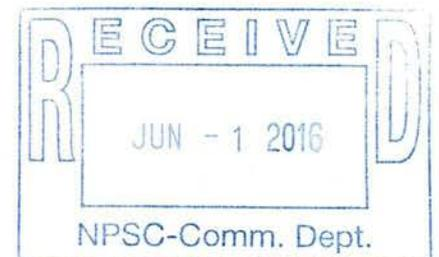

NOTICE

THE INFORMATION CONTAINED IN THIS DOCUMENT IS SUBJECT TO CHANGE.
NE2016-001

15. COMMON CHANNEL SIGNALING NETWORK (CCSN)

15.5 ORDERING, SERVICE PROVISIONING AND PERFORMANCE REQUIREMENTS

15.5.1 CCSAC ORDERING REQUIREMENTS (Cont'd)

The Company will allow Company provided hubbing arrangements in association with CCSAC. If the customer has an existing DS3 facility (ordered and provisioned from Section 6, preceding, or Section 7, of the Interstate Access Service Tariff, F.C.C. No. 11.) to a Company Hub, the customer may use a portion of the DS3 facility (i.e., DS1) for the CCS Link(s) from the SWC of the customer's SPOI to the Company Hub and then order the DS1 or DS0 DLT from the Company Hub to the Company's STP. If the customer requests a DS1 DLT, multiplexing equipment must be ordered at the Company's STP. CCSAC orders are subject to the provisions (e.g., access order intervals, modification charges, cancellation charges and minimum periods) specified in Section 5, preceding.

(T)

When a customer orders CCSAC in association with other services (e.g., FGD with SS7 Out of Band Signaling for call set-up), separate orders shall be issued.

15.5.2 CCSAC SERVICE PROVISIONING

CCSAC transmission specifications, diversity requirements, testing parameters and design requirements for STP Links (i.e., CCS Signaling Links) are set forth in Technical References GR-905-CORE, GR-954-CORE and 77342. CCSAC network interface specifications between the Company STP location and the customer's STP location supporting Integrated Services Digital Network (ISDN) signaling are described in Technical Reference GR-905-CORE. CCSAC is provided from either the customer's Signaling Point (SP) which requires a minimum of two STP Links and two STP Ports or from the customer's STP which requires a minimum of four STP Links and four STP Ports. A group of signaling links that connect the same two signaling points is described as a link set. There are a maximum of 16 signaling links located within one link set. The quantity of CCS Links required is based upon diversity requirements. Diversity is provided as mutually agreed upon by the Company and the customer based upon the availability of facilities from the customer's SPOI location to the Company's STP. If applicable, Special Construction regulations and charges apply. CCSAC interconnection is available only in suitably equipped Company STP locations.

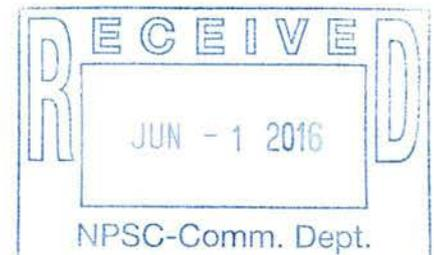

NOTICE

THE INFORMATION CONTAINED IN THIS DOCUMENT IS SUBJECT TO CHANGE.
NE2016-001

15. COMMON CHANNEL SIGNALING NETWORK (CCSN)

15.5 ORDERING, SERVICE PROVISIONING AND PERFORMANCE REQUIREMENTS (Cont'd)

(M)

15.5.3 CCSAC PERFORMANCE REQUIREMENTS

The Company supports the performance standards for CCSN as defined in Technical References GR-905-CORE and 77342. The overall end-to-end CCSN network objective from any SP to any other SP is less than ten minutes unavailable access per year based on design and diversity requirements and the performance objective for any single SP, including a Service Control Point (SCP), is less than three minutes unavailable access per year. The combined link set from the SCP to the Signal Transfer Point (STP) has a performance objective of less than two minutes unavailable access per year.

(T)

(M)

The Company will administer its CCSN network to ensure acceptable service provision levels. The Company maintains the right to apply protective controls to its CCSN as a result of occurrences such as failure or overload of CCSN facilities, natural disasters, mass calling or national security demands. In the event that the protective controls applied by the Company result in the complete loss of CCSAC Service by the customer, the customer will be entitled to a credit allowance for Switched Access Service interruptions as set forth in 2.4.5, preceding.

(M1)

15.6 TESTING REQUIREMENTS

15.6.1 CCSAC ACCEPTANCE TESTING REQUIREMENTS

At no additional charge, the Company will cooperatively test with the customer, at the time of installation, network compatibility and other operational tests for CCSAC as described in Technical Reference 77342 and GR-905-CORE.

(T)

When Clear Channel Capability on FGD Service is ordered as described in 6.3.1, preceding, the Company will cooperatively test with the customer, at the time of installation, CCSAC network compatibility and other operational tests for ISDN interworking as described in Technical Reference GR-905-CORE, at no additional charge.

Successful completion and acceptance of all testing requirements must occur in order to receive CCSAC Service.

(M1)

(M) Material moved from Page 6.
(M1) Material moved from Page 7.

(D)

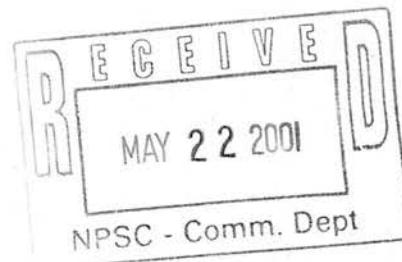

15. COMMON CHANNEL SIGNALING NETWORK (CCSN)

15.6 TESTING REQUIREMENTS (Cont'd)

(M)

15.6.2 CCSAC ADDITIONAL COOPERATIVE ACCEPTANCE TESTING REQUIREMENTS

Additional Cooperative Acceptance Testing will be performed on a cooperative basis with the customer. Additional Cooperative Acceptance tests for CCSAC are described in Technical References 77342 and GR-905-CORE.

(T)

(T)

Rates and charges for Additional Cooperative Acceptance Testing are described in Section 12, preceding.

(T-M)

15.7 CCSAC SERVICE APPLICATIONS

(N)

15.7.1 CALL SET-UP

This application provides the customer the capability to send originating and terminating call set-up signaling information, via ISUP messages, between the customer's designated premises, the Company's STP and other entities in association with message telecommunications service.

Call Set-Up may be associated with calls that utilize the Company's switched access network or may be associated with calls that do not utilize the Company's switched access network. If the message trunks are provided by the Company, the customer must order the associated FGD trunks with SS7 Out of Band Signaling option as set forth in Section 6, preceding. Call Set-Up associated with calls that do not utilize the Company's Switched Access network is referred to as transient call set-up and the customer must have message trunks with SS7 capabilities. CCSAC Service as set forth in this section is required to provide both capabilities.

15.7.2 FOREIGN DATABASE QUERIES

This service provides the customer the ability to query foreign databases (databases not maintained by the Company) by sending signaling information via TCAP messages between the Company's STP, the customer's designated premises and foreign databases (those not owned by the Company). CCSAC Service as set forth in this section is required to provide this capability.

(N)

(M1)

(M) Material moved from Page 7.

(M1) Material moved to Page 10.

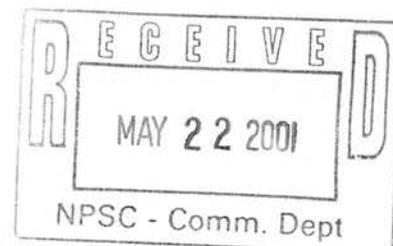

NOTICE

THE INFORMATION CONTAINED IN THIS DOCUMENT IS SUBJECT TO CHANGE.
NE2001-041

Qwest Corporation d/b/a CenturyLink QC
Access Service
Catalog

SECTION 15
 Page 10
 Release 6
 Effective: 03-31-2017

(C)

State of Nebraska
 Notified: 03-20-2017

15. COMMON CHANNEL SIGNALING NETWORK (CCSN)

15.8 RATES AND CHARGES

A. Common Channel Signaling Access Capability

	MONTHLY RATE	
1. Entrance Facility		(T)
• Per DS1	\$ 92.18	(T)
• Per DS3[1]	1,083.53	(T)
2. Direct Link Transport		

MILEAGE BANDS	MONTHLY RATE		
	FIXED	PER MILE	
a. DS0 Facility			
0	-	-	(T)
Over 0 to 8	\$ 20.86	\$ 0.27	
Over 8 to 25	21.28	0.15	
Over 25 to 50	20.37	0.13	
Over 50	24.46	0.29	
b. DS1 Facility			
0	-	-	(T)
Over 0 to 8	45.27	6.85	
Over 8 to 25	57.70	7.23	
Over 25 to 50	62.71	7.61	
Over 50	69.05	7.96	
c. DS3 Facility[1]			
0	-	-	(T)
Over 0 to 8	429.89	71.01	
Over 8 to 25	412.09	45.79	
Over 25 to 50	413.55	46.72	
Over 50	520.36	58.94	

[1] For Shared Use only as set forth in 2.7, preceding.



Qwest Corporation d/b/a CenturyLink QC

Access Service
Catalog

SECTION 15

Page 11

Release 11

State of Nebraska

Notified: 03-20-2017

Effective: 03-31-2017

15. COMMON CHANNEL SIGNALING NETWORK (CCSN)

15.8 RATES AND CHARGES

A. Common Channel Signaling Access Capability (Cont'd)

	NONRECURRING CHARGE	MONTHLY RATE	(T)
3. CCS Link			
• First CCS Link	\$567.00	-	(T)
• Each additional	180.00	-	(T)
4. STP PORT, per port	-	\$465.00	(T)
5. Multiplexing			
• DS1 to Voice	-	199.98	(T)
• DS3 to DS1[1]	-	252.37	(T)

B. Message Charge

	INTRASTATE RATE	OTHER RATE	
1. Signal Formulation			
• ISUP, Per call set-up request			
- Originating	\$0.000829	-	
- Terminating	0.000000	-	
2. Signal Transport			
• ISUP, Per call set-up request			
- Originating	0.000559	-	
- Terminating	0.000000	-	
• TCAP, Per data request	0.000418	-	
3. Signal Switching			
• Per ISUP, Per call set-up request			
- Originating	0.001162	-	
- Terminating	0.000000	-	
• Per TCAP, Per data request	0.000460	-	

[1] For Shared Use only as set forth in 2.7, preceding.



Qwest Corporation
Access Service
Catalog

SECTION 21
Index Page 1
Release 2

State of Nebraska
Notified: 02-05-2001

Effective: 02-15-2001

21. EXPANDED INTERCONNECTION (EI) SERVICE

SUBJECT	PAGE	
Expanded Interconnection Channel Termination	3	
General	1	
Rate Terms and Conditions.....	4	(T)
Rates and Charges	6	
Service Description.....	3	
Switched Access Service Virtual EI		
Rates and Charges	6	
Types of Rates and Charges	4	

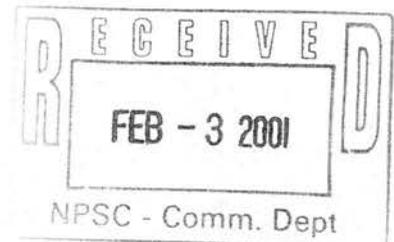

Qwest Corporation
Access Service
Catalog

SECTION 21

Page 1

Release 1

Effective: 9-29-2000

State of Nebraska
Notified: 9-29-2000

21. EXPANDED INTERCONNECTION (EI) SERVICE

21.1 GENERAL

Expanded Interconnection (EI) Service provides for wire center interconnection of Company-provided Switched Access DS1 or DS3 capacity services to interconnector-provided or -designated transmission equipment as described in the Private Line Transport Services Tariff.

EI may be accomplished through a virtual interconnection arrangement. The Company is solely responsible for the determination of whether a virtual interconnection arrangement is available from its wire center. Each wire center where Physical or Virtual EI Service is available is identified in the National Exchange Carrier Association, Inc. F.C.C. No. 4.

Technical information for EI Service may be found in Qwest Corporation Technical Reference 77201. Technical information for DS1 Service and DS3 Service may be found in Qwest Corporation Technical Reference 77375 and 77324, respectively.

EI Service will be provided utilizing a Switched Access Service Expanded Interconnection Channel Termination (EICT) DS1 or EICT DS3. EICT DS1 and DS3 may be ordered for connection with Switched Access DS1 or DS3 capacity services as set forth in Section 6, preceding. The Company will provide interconnection at a 1.544 Mbps or a 44.736 Mbps transmission rate.

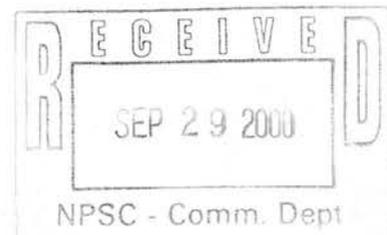

Qwest Corporation
Access Service
Catalog

SECTION 21

Page 2

Release 1

State of Nebraska
Notified: 9-29-2000

Effective: 9-29-2000

21. EXPANDED INTERCONNECTION (EI) SERVICE

21.1 GENERAL (Cont'd)

When an EICT DS1 or EICT DS3 connects to Switched Access Service, the Entrance Facility is not required.

When a Switched EICT DS1 or EICT DS3 connects to Switched Access Service and a multiplexing arrangement as described in 6.1.2 is required, the multiplexing arrangement may be ordered by and billed to the interconnector or the customer of record for Switched Access.

The regulations described herein are in addition to the terms and conditions elsewhere in this Catalog.

Virtual EICT DS1 or EICT DS3 can only be ordered by and billed to the customer of record of the fiber optic cable at the Company-designated point of interconnection serving the wire center.

The Company will work cooperatively with the interconnector in matters of joint testing and maintenance, as set forth in Section 13, preceding.



21. EXPANDED INTERCONNECTION (EI) SERVICE

21.2 SERVICE DESCRIPTION

21.2.1 EXPANDED INTERCONNECTION CHANNEL TERMINATION

A. Virtual EICT DS1

A Virtual EICT DS1 is a high capacity channel for the transmission of 1.544 Mbps isochronous serial data having a line code of bipolar with alternate mark inversion or Bipolar with Eight Zero Substitution (B8ZS). The 1.544 Mbps signal consists of 1.536 Mbps of customer information and .008 Mbps signal for other use, (e.g. framing and synchronization).

Switched Access Service Virtual EICT DS1 is provided between Company-owned, interconnector-designated terminating equipment and a Company Switched Access DS1 capacity service ordered from Section 6, preceding.

B. Virtual EICT DS3

A Virtual EICT DS3 is a high capacity channel for the transmission of 44.736 Mbps isochronous serial data having a line code of Bipolar with Three Zero Substitution (B3ZS).

Switched Access Service Virtual EICT DS3 is provided between the Company-owned, interconnector-designated terminating equipment and a Company Switched Access DS3 capacity service ordered from Section 6, preceding.



21. EXPANDED INTERCONNECTION (EI) SERVICE

21.3 RATE TERMS AND CONDITIONS

(T)

This section contains specific terms and conditions governing the rates and charges that apply for EI Service. Company services purchased by the interconnector for interconnection with EI Service are subject to appropriate nonrecurring charges, monthly rates and other applicable rates and charges as set forth in Section 6, preceding.

(T)

21.3.1 TYPES OF RATES AND CHARGES

There are two types of rates and charges. These are monthly rates and nonrecurring charges. The rates and charges are described as follows:

A. Monthly Rates

Monthly rates are recurring rates that apply each month or fraction thereof that an EI Service is provided. For billing purposes, each month is considered to have thirty (30) days.

The Virtual EI Channel Termination (EICT) rate element provides for the communications path between the interconnector-designated equipment and a Company Switched Transport DS1 or DS3 capacity service within the same wire center. Included as part of the EICT is a standard channel interface arrangement which defines the technical characteristics associated with the type of facilities to which the Switched Access Service is to be connected and the type of signaling capability, if any.

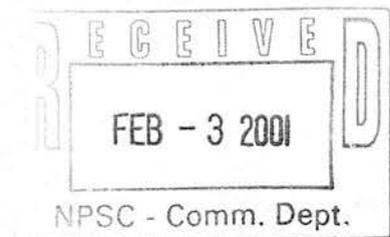

NOTICE

THE INFORMATION CONTAINED IN THIS DOCUMENT IS SUBJECT TO CHANGE.

Qwest Corporation
Access Service
Catalog

SECTION 21

Page 5

Release 2

Effective: 02-15-2001

State of Nebraska

Notified: 02-05-2001

21. EXPANDED INTERCONNECTION (EI) SERVICE

21.3 RATE TERMS AND CONDITIONS

(T)

21.3.1 TYPES OF RATES AND CHARGES (Cont'd)

B. Nonrecurring Charges

Nonrecurring charges are one-time charges that apply for a specific work activity (i.e., installation or change to an existing service). The types of nonrecurring charges that apply for EI Service include: installation of EICT DS1 or DS3 Channel Terminations.

Nonrecurring charges applicable to each EICT DS1 or EICT DS3 channel termination installed are set forth in 21.4, following.

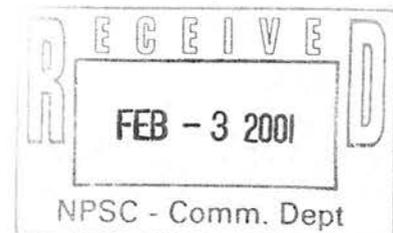

NOTICE

THE INFORMATION CONTAINED IN THIS DOCUMENT IS SUBJECT TO CHANGE.

NE2001-008

Qwest Corporation d/b/a CenturyLink QC
Access Service
Catalog

SECTION 21
Page 6
Release 2
Effective: 03-31-2017

(C)

State of Nebraska
Notified: 03-20-2017

21. EXPANDED INTERCONNECTION (EI) SERVICE

21.4 RATES AND CHARGES

21.4.1 SWITCHED ACCESS SERVICE VIRTUAL EI

	NONRECURRING CHARGE	MONTHLY RATE	(T)
Virtual EI Channel Termination, per termination			
• DS1 Switched Transport	\$313.25	\$17.22	(T)
• DS3 Switched Transport	329.00	52.50	(T)

